

R76H, 125°C Double Metallized Polypropylene Film, Radial, DC and Pulse Applications (Automotive Grade)

Overview

The R76H Series is constructed of polypropylene film and double metallized polyester film as electrodes with radial leads of tinned wire. The radial leads are electrically welded to the metal layer on the ends of the capacitor winding. The capacitor is encapsulated in a self-extinguishing solvent resistant plastic case with thermosetting resin material meeting UL 94 V-0 requirements. Two different winding constructions are used depending on voltage parameters. Please see the Performance Characteristics for more information.

Automotive grade devices meet the demanding Automotive Electronics Council's AEC-Q200 qualification requirements.

Applications

Typical applications include resonant circuit, high frequency high current, snubber and silicon-controlled rectifier (SCR and IGBT) and SiC (e.g. MOSFET) commutation circuits as well as applications with high voltage and high current in combination with a high ambient temperature.

Not suitable for across-the-line application (see Suppressor Capacitors).

Benefits

- Voltage range: 250 – 2,000 VDC
- Capacitance range: 100 pF – 15 μ F
- Lead Spacing: 10 mm – 37.5 mm
- Capacitance tolerance: \pm 2.5%, \pm 5%, \pm 10%
- Climatic category: 55/125/56 IEC 60068-1
- Operating temperature range of -55°C to +125°C
- Usable in harsh environment at 85°C/85% R.H. up to 1,000 hours
- RoHS compliance and lead-free terminations
- Tape & Reel packaging in accordance with IEC 60286-2
- Self-healing
- Automotive (AEC-Q200) grade

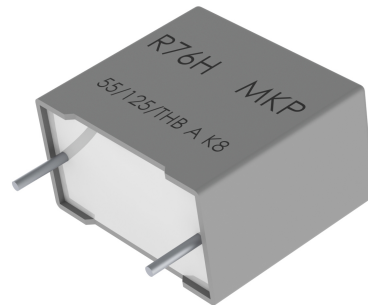

Part Number System

| R76 | T | R | 3330 | SE | 30 | | K |
|---------------------------------|--|--|--|----------------------------|----------------------------|----------------------------|--|
| Series | Rated Voltage (VDC) | Lead Spacing (mm) | Capacitance Code (pF) | Packaging | Internal Use | | Capacitance Tolerance |
| Double Metallized Polypropylene | I = 250 M = 400 P = 630 Q = 1,000 T = 1,600 U = 2,000 | F = 10 I = 15 N = 22.5 R = 27.5 W = 37.5 | The last three digits represent significant figures. The first digit specifies the total number of zeros to be added. | See Ordering Options Table | H0 H1 H2 H3 H4 | H5 H6 H7 H8 HL | H = \pm 2.5% (*) J = \pm 5% K = \pm 10% (*) = for C \geq 1,000 pF |

One world. One KEMET

Ordering Options Table

| Lead Spacing Nominal (mm) | Type of Leads and Packaging | Lead Length (mm) | Lead and Packaging Code |
|---------------------------|--|---------------------------|-------------------------|
| 10 15 22.5 | Standard Lead and Packaging Options | | |
| | Bulk (Bag) – Short Leads | 4 +2/-0 | SE |
| | Ammo Pack | H ₀ = 18.5±0.5 | DQ |
| | Other Lead and Packaging Options | | |
| | Tape & Reel (Standard Reel Ø 355 mm) | H ₀ = 18.5±0.5 | GY |
| | Tape & Reel (Large Reel Ø 500 mm) | H ₀ = 18.5±0.5 | CK |
| | Bulk (Bag) – Short Leads | 2.7 +0.5/-0 | JA |
| | Bulk (Bag) – Short Leads | 3.5 +0.5/-0 | JB |
| | Bulk (Bag) – Short Leads | 10±1 | JC |
| | Bulk (Bag) – Short Leads | 4.0 +0.5/-0 | JE |
| | Bulk (Bag) – Short Leads | 3.2 +0.3/-0.2 | JH |
| | Bulk (Bag) – Long Leads | 18±1 | JM |
| | Bulk (Bag) – Long Leads | 30 +5/-0 | 40 |
| | Bulk (Bag) – Long Leads | 25 +2/-1 | 50 |
| 27.5 | Standard Lead and Packaging Options | | |
| | Bulk (Tray) – Short Leads | 4 +2/-0 | SE |
| | Other Lead and Packaging Options | | |
| | Tape & Reel (Standard Reel Ø 355 mm) | H ₀ = 18.5±0.5 | GY |
| | Tape & Reel (Large Reel Ø 500 mm) | H ₀ = 18.5±0.5 | CK ¹ |
| | Bulk (Tray) – Short Leads | 3.5 +0.5/-0 | JB |
| | Bulk (Tray) – Short Leads | 4.0 +0.5/-0 | JE |
| | Bulk (Tray) – Short Leads | 3.2 +0.3/-0.2 | JH |
| | Bulk (Tray) – Long Leads | 30 +5/-0 | 40 |
| | Bulk (Tray) – Long Leads | 25 +2/-1 | 50 |
| 37.5 | Standard Lead and Packaging Options | | |
| | Bulk (Tray) – Short Leads | 4 +2/-0 | SE |
| | Other Lead and Packaging Options | | |
| | Bulk (Tray) – Short Leads | 3.5 +0.5/-0 | JB |
| | Bulk (Tray) – Short Leads | 4.0 +0.5/-0 | JE |
| | Bulk (Tray) – Short Leads | 3.2 +0.3/-0.2 | JH |
| | Bulk (Tray) – Long Leads | 30 +5/-0 | 40 |
| Bulk (Tray) – Long Leads | 25 +2/-1 | 50 | |

¹ = Not for all sizes, see "Packaging Quantities" table.

Dimensions – Millimeters

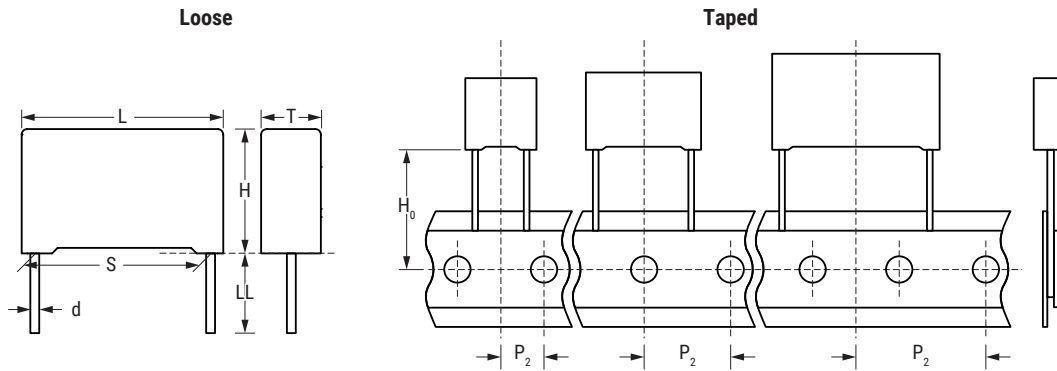

| S | | T | | H | | L | | d | |
|---------|-----------|---------|-----------|---------|-----------|---------|-----------|---------|-----------|
| Nominal | Tolerance | Nominal | Tolerance | Nominal | Tolerance | Nominal | Tolerance | Nominal | Tolerance |
| 10.0 | ±0.4 | 4.0 | +0.2/-0.5 | 9.0 | +0.1/-0.5 | 13.0 | +0.2/-0.5 | 0.6 | ±0.05 |
| 10.0 | ±0.4 | 5.0 | +0.2/-0.5 | 11.0 | +0.1/-0.5 | 13.0 | +0.2/-0.5 | 0.6 | ±0.05 |
| 10.0 | ±0.4 | 6.0 | +0.2/-0.5 | 12.0 | +0.1/-0.5 | 13.0 | +0.2/-0.5 | 0.6 | ±0.05 |
| 15.0 | ±0.4 | 4.0 | +0.2/-0.5 | 10.0 | +0.1/-0.5 | 18.0 | +0.3/-0.5 | 0.8 | ±0.05 |
| 15.0 | ±0.4 | 5.0 | +0.2/-0.5 | 11.0 | +0.1/-0.5 | 18.0 | +0.3/-0.5 | 0.8 | ±0.05 |
| 15.0 | ±0.4 | 6.0 | +0.2/-0.5 | 12.0 | +0.1/-0.5 | 18.0 | +0.3/-0.5 | 0.8 | ±0.05 |
| 15.0 | ±0.4 | 7.5 | +0.2/-0.5 | 13.5 | +0.1/-0.5 | 18.0 | +0.5/-0.5 | 0.8 | ±0.05 |
| 15.0 | ±0.4 | 8.5 | +0.2/-0.5 | 14.5 | +0.1/-0.5 | 18.0 | +0.5/-0.5 | 0.8 | ±0.05 |
| 15.0 | ±0.4 | 9.0 | +0.2/-0.5 | 12.5 | +0.1/-0.5 | 18.0 | +0.5/-0.5 | 0.8 | ±0.05 |
| 15.0 | ±0.4 | 10.0 | +0.2/-0.5 | 16.0 | +0.1/-0.5 | 18.0 | +0.5/-0.5 | 0.8 | ±0.05 |
| 15.0 | ±0.4 | 11.0 | +0.2/-0.5 | 19.0 | +0.1/-0.5 | 18.0 | +0.5/-0.5 | 0.8 | ±0.05 |
| 15.0 | ±0.4 | 13.0 | +0.2/-0.5 | 12.0 | +0.1/-0.5 | 18.0 | +0.5/-0.5 | 0.8 | ±0.05 |
| 22.5 | ±0.4 | 6.0 | +0.2/-0.5 | 15.0 | +0.1/-0.5 | 26.5 | +0.3/-0.5 | 0.8 | ±0.05 |
| 22.5 | ±0.4 | 7.0 | +0.2/-0.5 | 16.0 | +0.1/-0.5 | 26.5 | +0.3/-0.5 | 0.8 | ±0.05 |

Note: See Ordering Options Table for lead length (LL/Ho) options.

Dimensions – Millimeters cont.

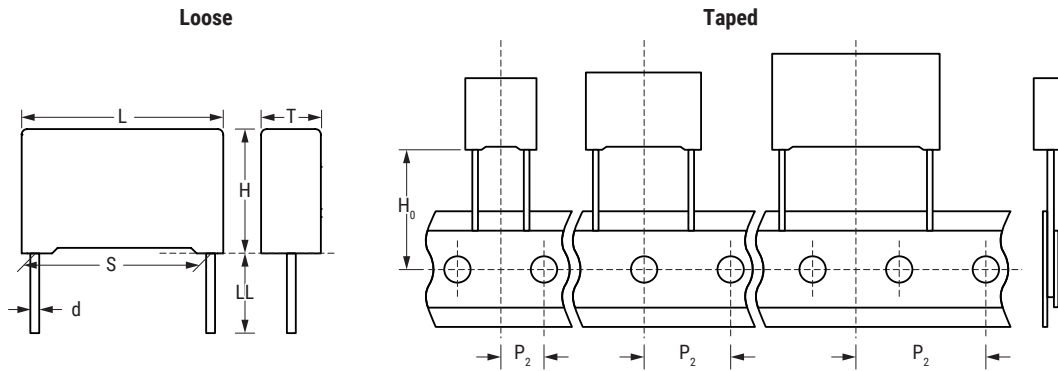

| S | | T | | H | | L | | d | |
|---------|-----------|---------|-----------|---------|-----------|---------|-----------|---------|-----------|
| Nominal | Tolerance | Nominal | Tolerance | Nominal | Tolerance | Nominal | Tolerance | Nominal | Tolerance |
| 22.5 | ±0.4 | 8.5 | +0.2/-0.5 | 17.0 | +0.1/-0.5 | 26.5 | +0.3/-0.5 | 0.8 | ±0.05 |
| 22.5 | ±0.4 | 10.0 | +0.2/-0.5 | 18.5 | +0.1/-0.5 | 26.5 | +0.3/-0.5 | 0.8 | ±0.05 |
| 22.5 | ±0.4 | 11.0 | +0.2/-0.5 | 20.0 | +0.1/-0.5 | 26.5 | +0.3/-0.5 | 0.8 | ±0.05 |
| 22.5 | ±0.4 | 13.0 | +0.2/-0.5 | 22.0 | +0.1/-0.5 | 26.5 | +0.3/-0.5 | 0.8 | ±0.05 |
| 27.5 | ±0.4 | 9.0 | +0.2/-0.7 | 17.0 | +0.1/-0.7 | 32.0 | +0.3/-0.7 | 0.8 | ±0.05 |
| 27.5 | ±0.4 | 11.0 | +0.2/-0.7 | 20.0 | +0.1/-0.7 | 32.0 | +0.3/-0.7 | 0.8 | ±0.05 |
| 27.5 | ±0.4 | 13.0 | +0.2/-0.7 | 22.0 | +0.1/-0.7 | 32.0 | +0.3/-0.7 | 0.8 | ±0.05 |
| 27.5 | ±0.4 | 13.0 | +0.2/-0.7 | 25.0 | +0.1/-0.7 | 32.0 | +0.3/-0.7 | 0.8 | ±0.05 |
| 27.5 | ±0.4 | 14.0 | +0.2/-0.7 | 28.0 | +0.1/-0.7 | 32.0 | +0.3/-0.7 | 0.8 | ±0.05 |
| 27.5 | ±0.4 | 18.0 | +0.2/-0.7 | 33.0 | +0.1/-0.7 | 32.0 | +0.3/-0.7 | 0.8 | ±0.05 |
| 27.5 | ±0.4 | 22.0 | +0.2/-0.7 | 37.0 | +0.1/-0.7 | 32.0 | +0.3/-0.7 | 0.8 | ±0.05 |
| 37.5 | ±0.4 | 11.0 | +0.3/-0.7 | 22.0 | +0.1/-0.7 | 41.5 | +0.3/-0.7 | 1.0 | ±0.05 |
| 37.5 | ±0.4 | 13.0 | +0.3/-0.7 | 24.0 | +0.1/-0.7 | 41.5 | +0.3/-0.7 | 1.0 | ±0.05 |
| 37.5 | ±0.4 | 16.0 | +0.3/-0.7 | 28.5 | +0.1/-0.7 | 41.5 | +0.3/-0.7 | 1.0 | ±0.05 |
| 37.5 | ±0.4 | 19.0 | +0.3/-0.7 | 32.0 | +0.1/-0.7 | 41.5 | +0.3/-0.7 | 1.0 | ±0.05 |
| 37.5 | ±0.4 | 20.0 | +0.3/-0.7 | 40.0 | +0.1/-0.7 | 41.5 | +0.3/-0.7 | 1.0 | ±0.05 |
| 37.5 | ±0.4 | 24.0 | +0.3/-0.7 | 44.0 | +0.1/-0.7 | 41.5 | +0.3/-0.7 | 1.0 | ±0.05 |
| 37.5 | ±0.4 | 24.0 | +0.3/-0.7 | 15.0 | +0.1/-0.7 | 41.5 | +0.3/-0.7 | 1.0 | ±0.05 |
| 37.5 | ±0.4 | 24.0 | +0.3/-0.7 | 19.0 | +0.1/-0.7 | 41.5 | +0.3/-0.7 | 1.0 | ±0.05 |
| 37.5 | ±0.4 | 30.0 | +0.3/-0.7 | 45.0 | +0.1/-0.7 | 41.5 | +0.3/-0.7 | 1.0 | ±0.05 |

Note: See Ordering Options Table for lead length (LL/Ho) options.

Performance Characteristics

| | | | | | | | |
|---|---|--------------------|--------------------|----------------------|----------------------|----------------------|------|
| Dielectric | Polypropylene film | | | | | | |
| Plates | Double sided metallized polyester film | | | | | | |
| Winding | Non-inductive type | | | | | | |
| Leads | Tinned wire | | | | | | |
| Protection | Plastic case, thermosetting resin filled. Box material is solvent resistant and flame retardant according to UL94. | | | | | | |
| Related Documents | IEC 60384-16 | | | | | | |
| Sections | 1 | | 2 | | | | |
| Rated Voltage V_R | 250 VDC 180 VAC | 400 VDC 250 VAC | 630 VDC 400 VAC | 1,000 VDC 600 VAC | 1,600 VDC 650 VAC | 2,000 VDC 700 VAC | |
| Capacitance Range (μF) | 0.027- 12 | 0.01 - 8.2 | 0.0039 - 4.7 | 0.00047 - 2.2 | 0.0033 - 1.2 | 0.00056 - 0.56 | |
| Capacitance Values | E12 series (IEC 60063) measured at 1 kHz and +20 \pm 1°C | | | | | | |
| Capacitance Tolerance | \pm 2.5%, \pm 5%, \pm 10% | | | | | | |
| Operating Temperature Range | -55°C to +125°C | | | | | | |
| Rated Temperature T_R | +105°C for V_R (DC and AC) | | | | | | |
| Voltage Derating | The following decreasing factor has to be applied on the rated voltage: +105°C to 125°C: 1.25% per °C for V_R (DC and AC) = operating voltage V_{op} | | | | | | |
| Climatic Category | 55/125/56 IEC 60068-1 | | | | | | |
| Storage Conditions | Storage time: \leq 24 months from the date marked on the package label | | | | | | |
| | Average relative humidity per year \leq 70% | | | | | | |
| | RH \leq 85% for 30 days randomly distributed throughout the year | | | | | | |
| | Dew is absent | | | | | | |
| | Temperature: -40 to 80°C (see "Maximum Humidity in Storage Conditions" graph below) | | | | | | |
| Test Voltage | 1.6 x V_R VDC for 2 seconds (between terminations) at +25°C \pm 5°C | | | | | | |
| Capacitance Drift | Maximum 0.5% after a 2 year storage period at a temperature of +10°C to +40°C and a relative humidity of 40% to 60% | | | | | | |
| Maximum Pulse Steepness | dV/dt according to Table 1. For working voltages lower than rated voltage ($V < V_R$), the specified dV/dt can be multiplied by the factor V_R/V . | | | | | | |
| Reliability (Reference IEC 61709) | Operational life at V_{op} (DC) > 200,000 hours at 85°C; 6,000 hours at 110°C; 3,000 hours at 125°C | | | | | | |
| | Failure rate \leq 1 FIT, $T = +40^\circ\text{C}$, $V = 0.5 \times V_R$ | | | | | | |
| | Failure criteria: open or short circuit, capacitance change > 10%, DF 2 times the catalog limits, IR < 0.005 x initial limit | | | | | | |
| Temperature Coefficient | -(200 \pm 100) ppm/°C at 1 kHz | | | | | | |
| Self-Inductance (Lead Length ~ 2 mm) | Lead Spacing (mm) | 7.5 | 10 | 15 | 22.5 | 27.5 | 37.5 |
| | L (nH) \approx | 8 | 9 | 10 | 16 | 18 | 20 |
| | Maximum 1 nH per 1 mm lead and capacitor length. | | | | | | |

Performance Characteristics cont.

| Dissipation Factor $\tan\delta$ | Measured at 25°C ±5°C | | | |
|---------------------------------|-----------------------|------------|---------------------|---------|
| | Frequency | C ≤ 0.1 μF | 0.1 μF < C ≤ 1.0 μF | C > 1μF |
| | 1 kHz | ≤ 0.03% | ≤ 0.03% | ≤ 0.04% |
| | 10 kHz | ≤ 0.04% | ≤ 0.06% | - |
| 100 kHz | ≤ 0.10% | - | - | |

| Insulation Resistance | Measured at +25°C, 100 VDC 60 seconds | |
|-----------------------|---------------------------------------|--|
| | Minimum Values Between Terminals | |
| | C ≤ 0.33 μF | C > 0.33 μF |
| | ≥ 100,000 MΩ (≥ 500,000 MΩ)* | ≥ 30,000 MΩ · μF (≥ 150,000 MΩ · μF)* |

* Typical value

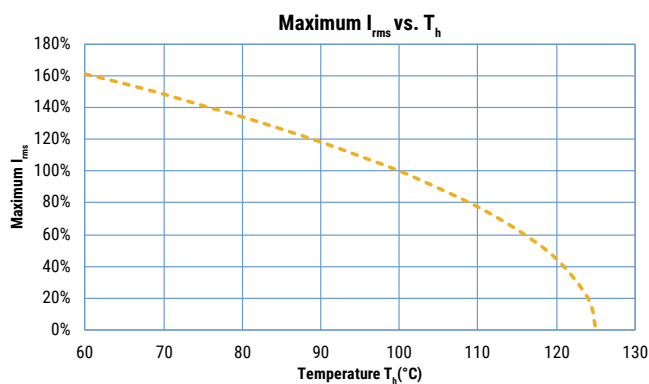
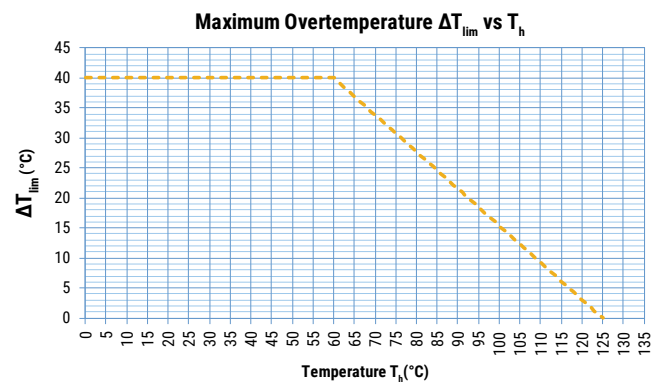

T_h is the maximum ambient temperature surrounding the capacitor or hottest contact point (e.g. tracks), whichever is higher, in the worst operation conditions in °C.

Qualification

Automotive Grade products meet or exceed the requirements outlined by the Automotive Electronics Council. Details regarding test methods and conditions are referenced in document AEC-Q200, Stress Test Qualification for Passive Components. For additional information regarding the Automotive Electronics Council and AEC-Q200, please visit their website at www.aecouncil.com.

Maximum Voltage (V_{rms}) Versus Frequency (Sinusoidal Waveform/ $T_h \leq 100^\circ\text{C}$)

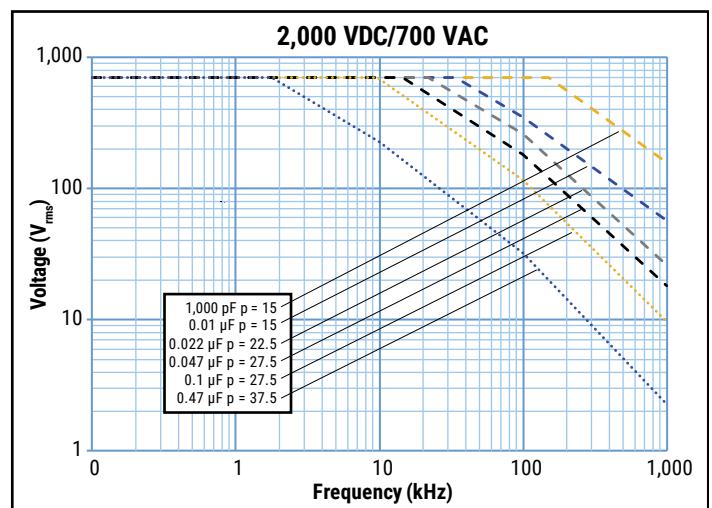
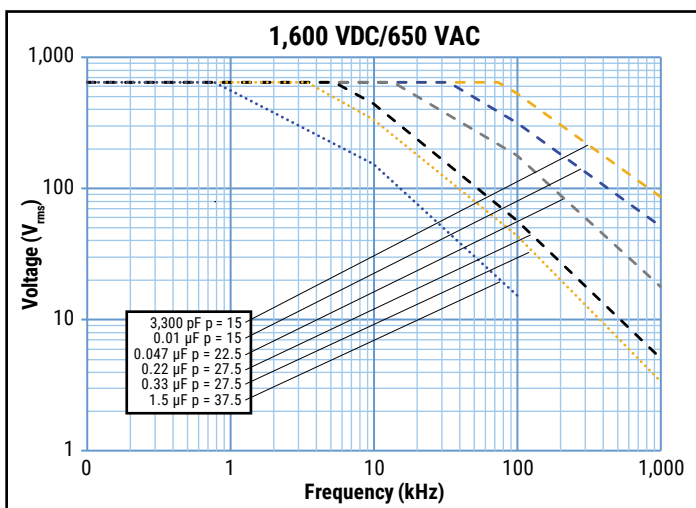
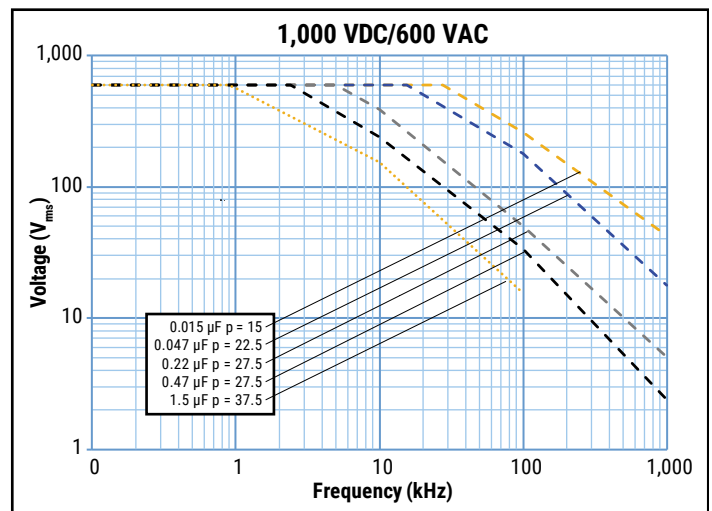
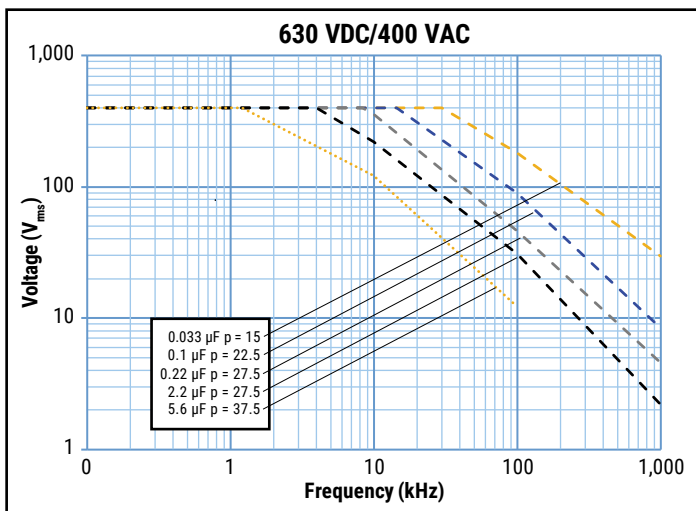
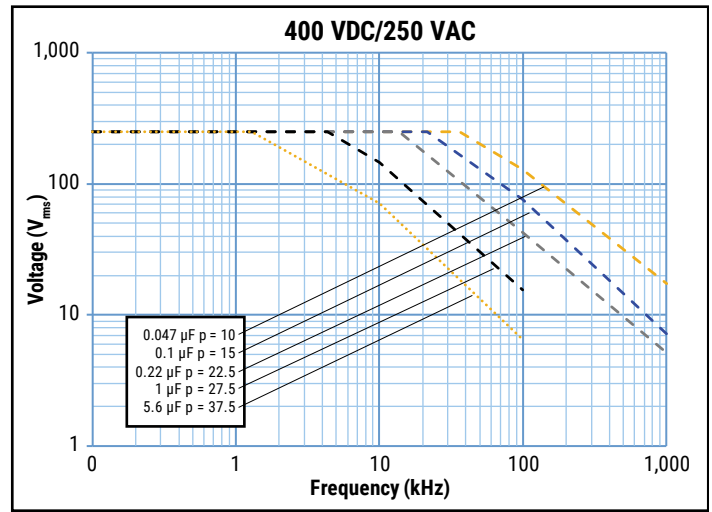
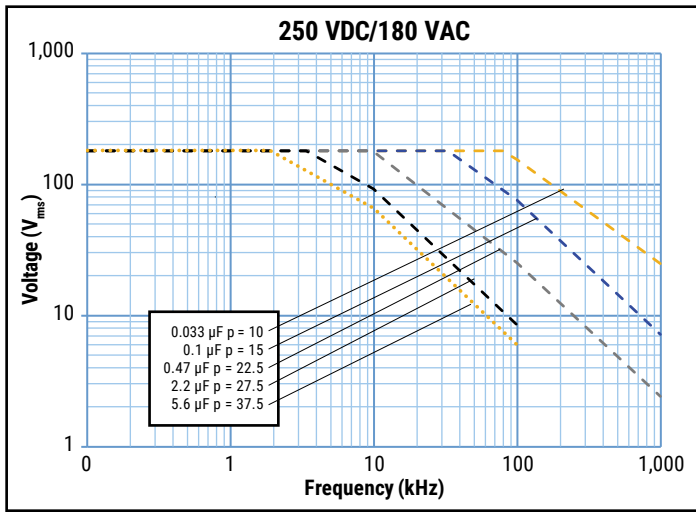

Maximum Current (I_{rms}) Versus Frequency (Sinusoidal Waveform/ $Th \leq 100^\circ C$)

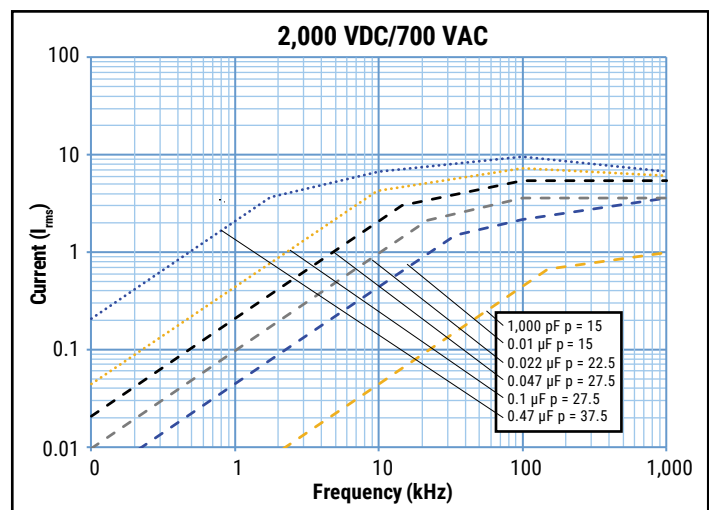
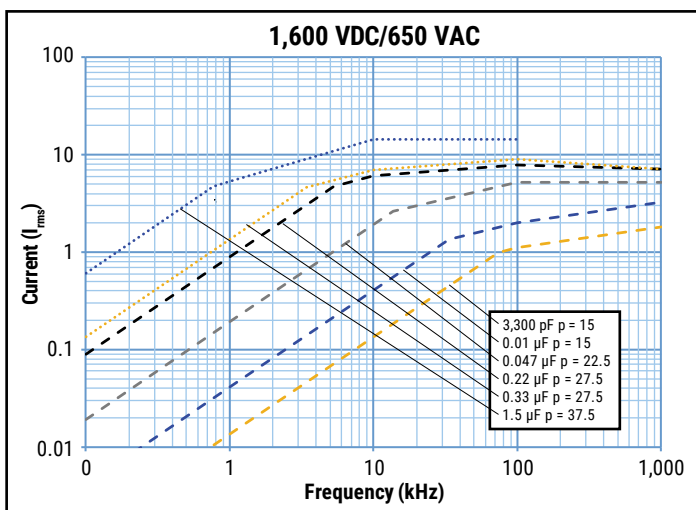
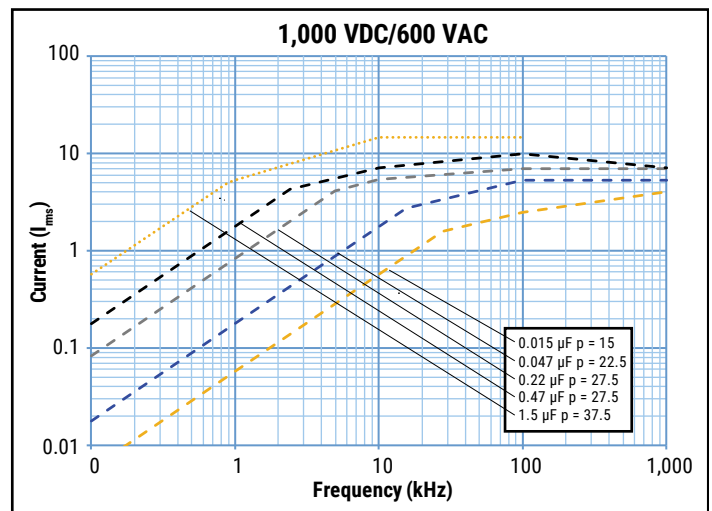
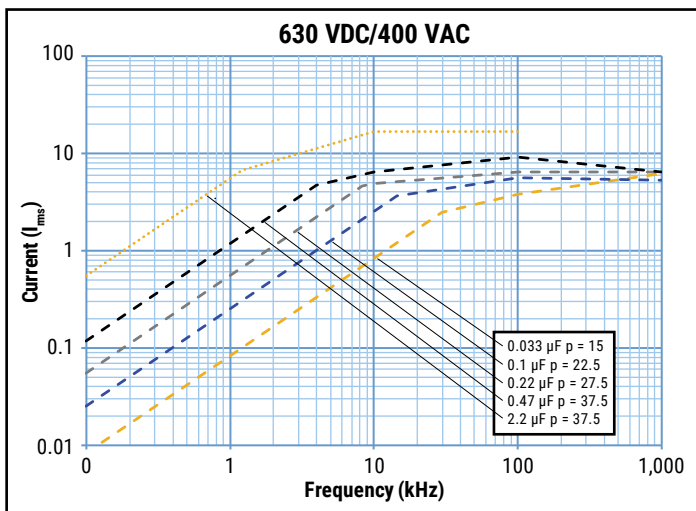
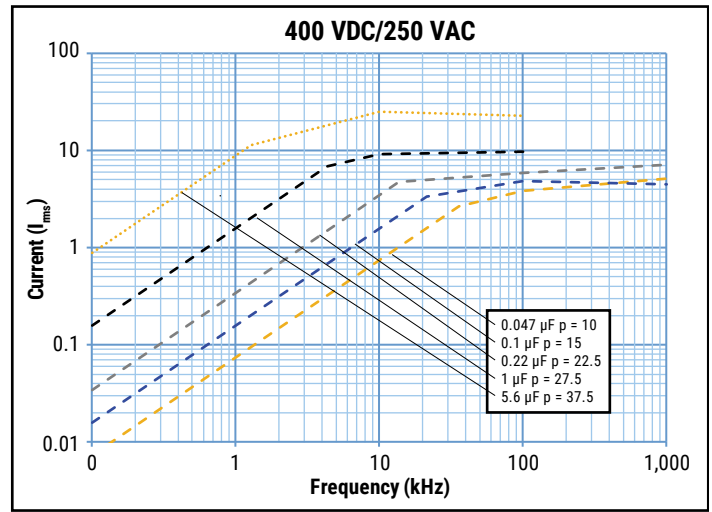
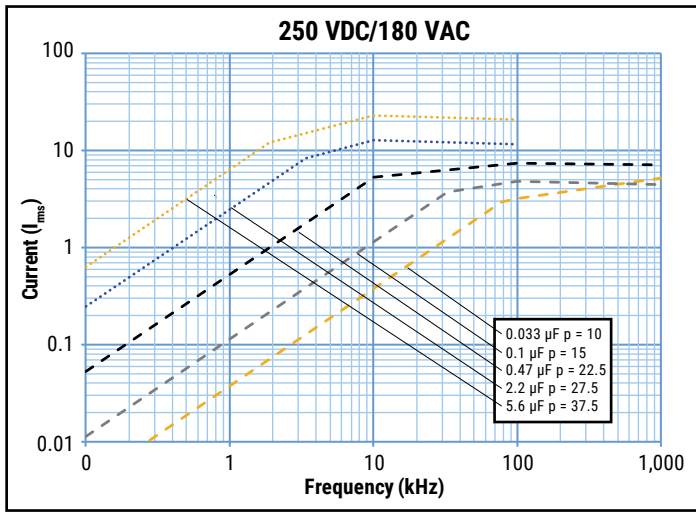

Environmental Test Data

| Damp Heat, Steady State Test | Test Conditions: | | Performances |
|-----------------------------------|---|---|---|
| | Temperature: Relative humidity (RH): Test duration: | +40°C ±2°C 93% ±2% 56 days | Δ C/C ≤ 2%, Δ tanδ ≤ 0.001 at 1 kHz IR after test ≥ 50% of initial limit |
| Endurance Test | Test Conditions | | Performances |
| | Temperature: Voltage applied: Test duration: | +105°C ±2°C 1.25 x V _R (DC) 2,000 hours | Δ C/C ≤ 2%, Δ tanδ ≤ 0.001 at 10 kHz for C ≤ 1 μF Δ tanδ ≤ 0.001 at 1 kHz for C > 1 μF IR after test ≥ 50% of initial limit |
| | Temperature: Relative humidity (RH): Voltage applied: Test duration: | +85°C ±2°C 85% ±2% 1.0 x VR (AC), 50/60 Hz 1,000 hours | Δ C/C ≤ 10%, Δ tanδ ≤ 0.001 at 1 kHz IR after test ≥ 50% of initial limit |
| | Temperature: Relative humidity (RH): Voltage applied: Test duration: | +85°C ±2°C 85% ±2% 1.0 x VR (DC) 1,000 hours | Δ C/C ≤ 10%, Δ tanδ ≤ 0.001 at 1 kHz IR after test ≥ 50% of initial limit |
| Resistance to Soldering Heat Test | Test Conditions | | Performances |
| | Solder bath temperature: Dipping time (with heat screen): | 260°C ±5°C 10 seconds ±1 second | Δ C/C ≤ 1%, Δ tanδ ≤ 0.001 at 10 kHz for C ≤ 1 μF Δ tanδ ≤ 0.001 at 1 kHz for C > 1 μF IR after test ≥ initial limit |

Environmental Compliance

All KEMET pulse capacitors are RoHS compliant.



Table 1 – Ratings & Part Number Reference

| VDC | VAC | Cap Value (µF) | Dimensions in mm | | | Lead Spacing (p) | dV/dt (V/µs) | Max K ₀ (V ² /µs) | I _{pk} | ESL | ESR | I _{rms} max (*) | R _{th} | KEMET Internal Part Number | Customer Part Number |
|-----|-----|----------------|------------------|------|------|------------------|--------------|---|-----------------|---------------------|------------|--------------------------|-----------------|----------------------------|----------------------|
| | | | | | | | | | | Lead Length 2x 4 mm | at 100 kHz | at 100 kHz, 100°C | (°C/W) | | |
| | | | A _{pk} | nH | mΩ | | | | | A _{rms} | (°C/W) | | | | |
| 250 | 180 | 0.0270 | 4.0 | 9.0 | 13.0 | 10.0 | 1,000 | 500,000 | 27 | 9 | 24 | 2.88 | 79 | 761F2270(1)H3(2) | R761F2270(1)H3(2) |
| 250 | 180 | 0.0330 | 4.0 | 9.0 | 13.0 | 10.0 | 1,000 | 500,000 | 33 | 9 | 19 | 3.19 | 79 | 761F2330(1)H3(2) | R761F2330(1)H3(2) |
| 250 | 180 | 0.0390 | 4.0 | 9.0 | 13.0 | 10.0 | 1,000 | 500,000 | 39 | 9 | 16 | 3.46 | 79 | 761F2390(1)H3(2) | R761F2390(1)H3(2) |
| 250 | 180 | 0.0470 | 5.0 | 11.0 | 13.0 | 10.0 | 1,000 | 500,000 | 47 | 9 | 14 | 4.05 | 69 | 761F2470(1)H3(2) | R761F2470(1)H3(2) |
| 250 | 180 | 0.0560 | 5.0 | 11.0 | 13.0 | 10.0 | 1,000 | 500,000 | 56 | 9 | 23 | 3.13 | 69 | 761F2560(1)H3(2) | R761F2560(1)H3(2) |
| 250 | 180 | 0.0680 | 6.0 | 12.0 | 13.0 | 10.0 | 1,000 | 500,000 | 68 | 9 | 19 | 3.59 | 64 | 761F2680(1)H3(2) | R761F2680(1)H3(2) |
| 250 | 180 | 0.0820 | 6.0 | 12.0 | 13.0 | 10.0 | 1,000 | 500,000 | 82 | 9 | 16 | 3.94 | 64 | 761F2820(1)H3(2) | R761F2820(1)H3(2) |
| 250 | 180 | 0.0680 | 5.0 | 11.0 | 18.0 | 15.0 | 550 | 275,000 | 37 | 10 | 19 | 3.69 | 60 | 761I2680(1)H3(2) | R761I2680(1)H3(2) |
| 250 | 180 | 0.0820 | 5.0 | 11.0 | 18.0 | 15.0 | 550 | 275,000 | 45 | 10 | 16 | 4.06 | 60 | 761I2820(1)H3(2) | R761I2820(1)H3(2) |
| 250 | 180 | 0.1000 | 5.0 | 11.0 | 18.0 | 15.0 | 550 | 275,000 | 55 | 10 | 13 | 4.48 | 60 | 761I3100(1)H3(2) | R761I3100(1)H3(2) |
| 250 | 180 | 0.1200 | 6.0 | 12.0 | 18.0 | 15.0 | 550 | 275,000 | 66 | 10 | 13 | 4.55 | 56 | 761I3120(1)H3(2) | R761I3120(1)H3(2) |
| 250 | 180 | 0.1500 | 6.0 | 12.0 | 18.0 | 15.0 | 550 | 275,000 | 83 | 10 | 11 | 5.09 | 56 | 761I3150(1)H3(2) | R761I3150(1)H3(2) |
| 250 | 180 | 0.1800 | 7.5 | 13.5 | 18.0 | 15.0 | 550 | 275,000 | 99 | 10 | 9 | 5.86 | 51 | 761I3180(1)H3(2) | R761I3180(1)H3(2) |
| 250 | 180 | 0.1800 | 9.0 | 12.5 | 18.0 | 15.0 | 550 | 275,000 | 99 | 10 | 9 | 5.92 | 50 | 761I3180(1)H7(2) | R761I3180(1)H7(2) |
| 250 | 180 | 0.2200 | 7.5 | 13.5 | 18.0 | 15.0 | 550 | 275,000 | 121 | 10 | 7 | 6.48 | 51 | 761I3220(1)H3(2) | R761I3220(1)H3(2) |
| 250 | 180 | 0.2200 | 9.0 | 12.5 | 18.0 | 15.0 | 550 | 275,000 | 121 | 10 | 7 | 6.55 | 50 | 761I3220(1)H7(2) | R761I3220(1)H7(2) |
| 250 | 180 | 0.2700 | 8.5 | 14.5 | 18.0 | 15.0 | 550 | 275,000 | 149 | 10 | 6 | 7.39 | 48 | 761I3270(1)H3(2) | R761I3270(1)H3(2) |
| 250 | 180 | 0.2700 | 9.0 | 12.5 | 18.0 | 15.0 | 550 | 275,000 | 149 | 10 | 6 | 7.25 | 50 | 761I3270(1)H7(2) | R761I3270(1)H7(2) |
| 250 | 180 | 0.3300 | 10.0 | 16.0 | 18.0 | 15.0 | 550 | 275,000 | 182 | 10 | 5 | 8.51 | 44 | 761I3330(1)H3(2) | R761I3330(1)H3(2) |
| 250 | 180 | 0.3300 | 13.0 | 12.0 | 18.0 | 15.0 | 550 | 275,000 | 182 | 10 | 5 | 8.43 | 45 | 761I3330(1)H7(2) | R761I3330(1)H7(2) |
| 250 | 180 | 0.3900 | 10.0 | 16.0 | 18.0 | 15.0 | 550 | 275,000 | 215 | 10 | 4 | 9.25 | 44 | 761I3390(1)H3(2) | R761I3390(1)H3(2) |
| 250 | 180 | 0.4700 | 11.0 | 19.0 | 18.0 | 15.0 | 550 | 275,000 | 259 | 10 | 3 | 10.62 | 40 | 761I3470(1)H3(2) | R761I3470(1)H3(2) |
| 250 | 180 | 0.2200 | 6.0 | 15.0 | 26.5 | 22.5 | 300 | 150,000 | 66 | 16 | 7 | 7.00 | 43 | 761N3220(1)H0(2) | R761N3220(1)H0(2) |
| 250 | 180 | 0.2700 | 6.0 | 15.0 | 26.5 | 22.5 | 300 | 150,000 | 81 | 16 | 6 | 7.75 | 43 | 761N3270(1)H3(2) | R761N3270(1)H3(2) |
| 250 | 180 | 0.3300 | 6.0 | 15.0 | 26.5 | 22.5 | 300 | 150,000 | 99 | 16 | 5 | 8.57 | 43 | 761N3330(1)H3(2) | R761N3330(1)H3(2) |
| 250 | 180 | 0.3900 | 7.0 | 16.0 | 26.5 | 22.5 | 300 | 150,000 | 117 | 16 | 4 | 9.58 | 41 | 761N3390(1)H3(2) | R761N3390(1)H3(2) |
| 250 | 180 | 0.4700 | 7.0 | 16.0 | 26.5 | 22.5 | 300 | 150,000 | 141 | 16 | 3 | 10.52 | 41 | 761N3470(1)H3(2) | R761N3470(1)H3(2) |
| 250 | 180 | 0.5600 | 8.5 | 17.0 | 26.5 | 22.5 | 300 | 150,000 | 168 | 16 | 3 | 11.87 | 38 | 761N3560(1)H3(2) | R761N3560(1)H3(2) |
| 250 | 180 | 0.6800 | 10.0 | 18.5 | 26.5 | 22.5 | 300 | 150,000 | 204 | 16 | 2 | 13.55 | 36 | 761N3680(1)H3(2) | R761N3680(1)H3(2) |
| 250 | 180 | 0.8200 | 10.0 | 18.5 | 26.5 | 22.5 | 300 | 150,000 | 246 | 16 | 2 | 14.88 | 36 | 761N3820(1)H3(2) | R761N3820(1)H3(2) |
| 250 | 180 | 1.0000 | 11.0 | 20.0 | 26.5 | 22.5 | 300 | 150,000 | 300 | 16 | 7 | 7.95 | 34 | 761N4100(1)H3(2) | R761N4100(1)H3(2) |
| 250 | 180 | 1.2000 | 13.0 | 22.0 | 26.5 | 22.5 | 300 | 150,000 | 360 | 16 | 16 | 5.55 | 31 | 761N4120(1)H3(2) | R761N4120(1)H3(2) |
| 250 | 180 | 1.0000 | 11.0 | 20.0 | 32.0 | 27.5 | 200 | 100,000 | 200 | 18 | 7 | 8.27 | 31 | 761R4100(1)H3(2) | R761R4100(1)H3(2) |
| 250 | 180 | 1.2000 | 11.0 | 20.0 | 32.0 | 27.5 | 200 | 100,000 | 240 | 18 | 16 | 5.55 | 31 | 761R4120(1)H4(2) | R761R4120(1)H4(2) |
| 250 | 180 | 1.5000 | 13.0 | 22.0 | 32.0 | 27.5 | 200 | 100,000 | 300 | 18 | 13 | 6.44 | 29 | 761R4150(1)H3(2) | R761R4150(1)H3(2) |
| 250 | 180 | 1.8000 | 13.0 | 25.0 | 32.0 | 27.5 | 200 | 100,000 | 360 | 18 | 11 | 7.23 | 28 | 761R4180(1)H2(2) | R761R4180(1)H2(2) |
| 250 | 180 | 2.2000 | 14.0 | 28.0 | 32.0 | 27.5 | 200 | 100,000 | 440 | 18 | 9 | 8.24 | 26 | 761R4220(1)H4(2) | R761R4220(1)H4(2) |
| 250 | 180 | 2.7000 | 18.0 | 33.0 | 32.0 | 27.5 | 200 | 100,000 | 540 | 18 | 7 | 9.73 | 23 | 761R4270(1)H3(2) | R761R4270(1)H3(2) |
| 250 | 180 | 3.3000 | 18.0 | 33.0 | 32.0 | 27.5 | 200 | 100,000 | 660 | 18 | 6 | 10.76 | 23 | 761R4330(1)H3(2) | R761R4330(1)H3(2) |
| 250 | 180 | 3.9000 | 18.0 | 33.0 | 32.0 | 27.5 | 200 | 100,000 | 780 | 18 | 5 | 11.70 | 23 | 761R4390(1)H3(2) | R761R4390(1)H3(2) |
| 250 | 180 | 4.7000 | 22.0 | 37.0 | 32.0 | 27.5 | 200 | 100,000 | 940 | 18 | 4 | 13.50 | 21 | 761R4470(1)H3(2) | R761R4470(1)H3(2) |
| 250 | 180 | 5.6000 | 22.0 | 37.0 | 32.0 | 27.5 | 200 | 100,000 | 1,120 | 18 | 3 | 14.74 | 21 | 761R4560(1)H4(2) | R761R4560(1)H4(2) |
| 250 | 180 | 1.2000 | 11.0 | 22.0 | 41.5 | 37.5 | 100 | 50,000 | 120 | 20 | 16 | 5.97 | 27 | 761W4120(1)H3(2) | R761W4120(1)H3(2) |
| 250 | 180 | 1.5000 | 11.0 | 22.0 | 41.5 | 37.5 | 100 | 50,000 | 150 | 20 | 13 | 6.68 | 27 | 761W4150(1)H3(2) | R761W4150(1)H3(2) |
| 250 | 180 | 1.5000 | 24.0 | 15.0 | 41.5 | 37.5 | 100 | 50,000 | 150 | 20 | 13 | 7.04 | 24 | 761W4150(1)HL(2) | R761W4150(1)HL(2) |
| 250 | 180 | 1.8000 | 11.0 | 22.0 | 41.5 | 37.5 | 100 | 50,000 | 180 | 20 | 11 | 7.31 | 27 | 761W4180(1)H3(2) | R761W4180(1)H3(2) |
| 250 | 180 | 1.8000 | 24.0 | 15.0 | 41.5 | 37.5 | 100 | 50,000 | 180 | 20 | 11 | 7.71 | 24 | 761W4180(1)HL(2) | R761W4180(1)HL(2) |
| 250 | 180 | 2.2000 | 13.0 | 24.0 | 41.5 | 37.5 | 100 | 50,000 | 220 | 20 | 9 | 8.37 | 25 | 761W4220(1)H3(2) | R761W4220(1)H3(2) |
| 250 | 180 | 2.2000 | 24.0 | 15.0 | 41.5 | 37.5 | 100 | 50,000 | 220 | 20 | 9 | 8.52 | 24 | 761W4220(1)HL(2) | R761W4220(1)HL(2) |
| 250 | 180 | 2.7000 | 16.0 | 28.5 | 41.5 | 37.5 | 100 | 50,000 | 270 | 20 | 7 | 9.82 | 23 | 761W4270(1)H2(2) | R761W4270(1)H2(2) |
| 250 | 180 | 2.7000 | 24.0 | 19.0 | 41.5 | 37.5 | 100 | 50,000 | 270 | 20 | 7 | 9.75 | 23 | 761W4270(1)HL(2) | R761W4270(1)HL(2) |

(1) Insert lead and packaging code. See Ordering Options Table for available options.

(2) H = 2.5% (only for C ≥ 1,000 pF), J = 5%, K = 10%

(*) I_{rms} value that leads to a ΔT of ≈ 15°C in the hot spot > T_{HS} = T_{AMB} + ΔT = 100°C + 15°C = 115°C

Table 1 – Ratings & Part Number Reference cont.

| VDC | VAC | Cap Value (µF) | Dimensions in mm | | | Lead Spacing (p) | dV/dt (V/µs) | Max K ₀ (V ² /µs) | I _{pk} | ESL | ESR | I _{rms} max (*) | R _{th} | KEMET Internal Part Number | Customer Part Number |
|-----|-----|----------------|---------------------|------------|-------------------|------------------|--------------|---|-----------------|---------------------|-----------------|--------------------------|-----------------|----------------------------|----------------------|
| | | | Lead Length 2x 4 mm | at 100 kHz | at 100 kHz, 100°C | | | | | R _{th} | | | | | |
| | | | | | | | | | | | A _{pk} | nH | mΩ | | |
| W | H | L | A _{pk} | nH | mΩ | A _{rms} | (°C/W) | | | | | | | | |
| 250 | 180 | 3.3000 | 16.0 | 28.5 | 41.5 | 37.5 | 100 | 50,000 | 330 | 20 | 6 | 10.86 | 23 | 76IW4330(1)H3(2) | R76IW4330(1)H3(2) |
| 250 | 180 | 3.3000 | 24.0 | 19.0 | 41.5 | 37.5 | 100 | 50,000 | 330 | 20 | 6 | 10.78 | 23 | 76IW4330(1)HL(2) | R76IW4330(1)HL(2) |
| 250 | 180 | 3.9000 | 16.0 | 28.5 | 41.5 | 37.5 | 100 | 50,000 | 390 | 20 | 5 | 11.80 | 23 | 76IW4390(1)H3(2) | R76IW4390(1)H3(2) |
| 250 | 180 | 4.7000 | 19.0 | 32.0 | 41.5 | 37.5 | 100 | 50,000 | 470 | 20 | 4 | 13.53 | 21 | 76IW4470(1)H3(2) | R76IW4470(1)H3(2) |
| 250 | 180 | 5.6000 | 20.0 | 40.0 | 41.5 | 37.5 | 100 | 50,000 | 560 | 20 | 3 | 15.51 | 19 | 76IW4560(1)H2(2) | R76IW4560(1)H2(2) |
| 250 | 180 | 6.8000 | 20.0 | 40.0 | 41.5 | 37.5 | 100 | 50,000 | 680 | 20 | 3 | 17.09 | 19 | 76IW4680(1)H3(2) | R76IW4680(1)H3(2) |
| 250 | 180 | 8.2000 | 24.0 | 44.0 | 41.5 | 37.5 | 100 | 50,000 | 820 | 20 | 2 | 19.58 | 17 | 76IW4820(1)H2(2) | R76IW4820(1)H2(2) |
| 250 | 180 | 10.0000 | 24.0 | 44.0 | 41.5 | 37.5 | 100 | 50,000 | 1,000 | 20 | 2 | 21.62 | 17 | 76IW5100(1)H3(2) | R76IW5100(1)H3(2) |
| 250 | 180 | 12.0000 | 30.0 | 45.0 | 41.5 | 37.5 | 100 | 50,000 | 1,200 | 20 | 2 | 24.56 | 16 | 76IW5120(1)H3(2) | R76IW5120(1)H3(2) |
| 400 | 250 | 0.0100 | 4.0 | 9.0 | 13.0 | 10.0 | 1,500 | 1,200,000 | 15 | 9 | 64 | 1.57 | 79 | 76MF2100(1)H0(2) | R76MF2100(1)H0(2) |
| 400 | 250 | 0.0120 | 4.0 | 9.0 | 13.0 | 10.0 | 1,500 | 1,200,000 | 18 | 9 | 53 | 1.88 | 79 | 76MF2120(1)H0(2) | R76MF2120(1)H0(2) |
| 400 | 250 | 0.0150 | 4.0 | 9.0 | 13.0 | 10.0 | 1,500 | 1,200,000 | 23 | 9 | 42 | 2.15 | 79 | 76MF2150(1)H3(2) | R76MF2150(1)H3(2) |
| 400 | 250 | 0.0180 | 4.0 | 9.0 | 13.0 | 10.0 | 1,500 | 1,200,000 | 27 | 9 | 35 | 2.35 | 79 | 76MF2180(1)H3(2) | R76MF2180(1)H3(2) |
| 400 | 250 | 0.0220 | 4.0 | 9.0 | 13.0 | 10.0 | 1,500 | 1,200,000 | 33 | 9 | 29 | 2.60 | 79 | 76MF2220(1)H3(2) | R76MF2220(1)H3(2) |
| 400 | 250 | 0.0270 | 5.0 | 11.0 | 13.0 | 10.0 | 1,500 | 1,200,000 | 41 | 9 | 24 | 3.07 | 69 | 76MF2270(1)H3(2) | R76MF2270(1)H3(2) |
| 400 | 250 | 0.0330 | 5.0 | 11.0 | 13.0 | 10.0 | 1,500 | 1,200,000 | 50 | 9 | 19 | 3.40 | 69 | 76MF2330(1)H3(2) | R76MF2330(1)H3(2) |
| 400 | 250 | 0.0390 | 6.0 | 12.0 | 13.0 | 10.0 | 1,500 | 1,200,000 | 59 | 9 | 16 | 3.84 | 64 | 76MF2390(1)H3(2) | R76MF2390(1)H3(2) |
| 400 | 250 | 0.0470 | 6.0 | 12.0 | 13.0 | 10.0 | 1,500 | 1,200,000 | 71 | 9 | 14 | 4.22 | 64 | 76MF2470(1)H3(2) | R76MF2470(1)H3(2) |
| 400 | 250 | 0.0330 | 5.0 | 11.0 | 18.0 | 15.0 | 900 | 720,000 | 30 | 10 | 19 | 3.64 | 60 | 76MI2330(1)H0(2) | R76MI2330(1)H0(2) |
| 400 | 250 | 0.0390 | 5.0 | 11.0 | 18.0 | 15.0 | 900 | 720,000 | 35 | 10 | 16 | 3.96 | 60 | 76MI2390(1)H3(2) | R76MI2390(1)H3(2) |
| 400 | 250 | 0.0470 | 5.0 | 11.0 | 18.0 | 15.0 | 900 | 720,000 | 42 | 10 | 14 | 4.34 | 60 | 76MI2470(1)H3(2) | R76MI2470(1)H3(2) |
| 400 | 250 | 0.0560 | 5.0 | 11.0 | 18.0 | 15.0 | 900 | 720,000 | 50 | 10 | 23 | 3.35 | 60 | 76MI2560(1)H3(2) | R76MI2560(1)H3(2) |
| 400 | 250 | 0.0680 | 6.0 | 12.0 | 18.0 | 15.0 | 900 | 720,000 | 61 | 10 | 19 | 3.83 | 56 | 76MI2680(1)H3(2) | R76MI2680(1)H3(2) |
| 400 | 250 | 0.0820 | 6.0 | 12.0 | 18.0 | 15.0 | 900 | 720,000 | 74 | 10 | 16 | 4.21 | 56 | 76MI2820(1)H3(2) | R76MI2820(1)H3(2) |
| 400 | 250 | 0.1000 | 7.5 | 13.5 | 18.0 | 15.0 | 900 | 720,000 | 90 | 10 | 13 | 4.88 | 51 | 76MI3100(1)H3(2) | R76MI3100(1)H3(2) |
| 400 | 250 | 0.1000 | 9.0 | 12.5 | 18.0 | 15.0 | 900 | 720,000 | 90 | 10 | 13 | 4.93 | 50 | 76MI3100(1)H7(2) | R76MI3100(1)H7(2) |
| 400 | 250 | 0.1200 | 7.5 | 13.5 | 18.0 | 15.0 | 900 | 720,000 | 108 | 10 | 13 | 4.78 | 51 | 76MI3120(1)H3(2) | R76MI3120(1)H3(2) |
| 400 | 250 | 0.1200 | 9.0 | 12.5 | 18.0 | 15.0 | 900 | 720,000 | 108 | 10 | 13 | 4.83 | 50 | 76MI3120(1)H7(2) | R76MI3120(1)H7(2) |
| 400 | 250 | 0.1500 | 8.5 | 14.5 | 18.0 | 15.0 | 900 | 720,000 | 135 | 10 | 11 | 5.51 | 48 | 76MI3150(1)H3(2) | R76MI3150(1)H3(2) |
| 400 | 250 | 0.1500 | 13.0 | 12.0 | 18.0 | 15.0 | 900 | 720,000 | 135 | 10 | 11 | 5.68 | 45 | 76MI3150(1)H7(2) | R76MI3150(1)H7(2) |
| 400 | 250 | 0.1800 | 10.0 | 16.0 | 18.0 | 15.0 | 900 | 720,000 | 162 | 10 | 9 | 6.28 | 44 | 76MI3180(1)H3(2) | R76MI3180(1)H3(2) |
| 400 | 250 | 0.1800 | 13.0 | 12.0 | 18.0 | 15.0 | 900 | 720,000 | 162 | 10 | 9 | 6.22 | 45 | 76MI3180(1)H7(2) | R76MI3180(1)H7(2) |
| 400 | 250 | 0.2200 | 10.0 | 16.0 | 18.0 | 15.0 | 900 | 720,000 | 198 | 10 | 7 | 6.94 | 44 | 76MI3220(1)H3(2) | R76MI3220(1)H3(2) |
| 400 | 250 | 0.2700 | 11.0 | 19.0 | 18.0 | 15.0 | 900 | 720,000 | 243 | 10 | 6 | 8.05 | 40 | 76MI3270(1)H3(2) | R76MI3270(1)H3(2) |
| 400 | 250 | 0.1200 | 6.0 | 15.0 | 26.5 | 22.5 | 500 | 400,000 | 60 | 16 | 13 | 5.17 | 43 | 76MN3120(1)H3(2) | R76MN3120(1)H3(2) |
| 400 | 250 | 0.1500 | 6.0 | 15.0 | 26.5 | 22.5 | 500 | 400,000 | 75 | 16 | 11 | 5.78 | 43 | 76MN3150(1)H3(2) | R76MN3150(1)H3(2) |
| 400 | 250 | 0.1800 | 6.0 | 15.0 | 26.5 | 22.5 | 500 | 400,000 | 90 | 16 | 9 | 6.33 | 43 | 76MN3180(1)H3(2) | R76MN3180(1)H3(2) |
| 400 | 250 | 0.2200 | 7.0 | 16.0 | 26.5 | 22.5 | 500 | 400,000 | 110 | 16 | 7 | 7.20 | 41 | 76MN3220(1)H3(2) | R76MN3220(1)H3(2) |
| 400 | 250 | 0.2700 | 8.5 | 17.0 | 26.5 | 22.5 | 500 | 400,000 | 135 | 16 | 6 | 8.24 | 38 | 76MN3270(1)H3(2) | R76MN3270(1)H3(2) |
| 400 | 250 | 0.3300 | 8.5 | 17.0 | 26.5 | 22.5 | 500 | 400,000 | 165 | 16 | 5 | 9.11 | 38 | 76MN3330(1)H3(2) | R76MN3330(1)H3(2) |
| 400 | 250 | 0.3900 | 10.0 | 18.5 | 26.5 | 22.5 | 500 | 400,000 | 195 | 16 | 4 | 10.26 | 36 | 76MN3390(1)H3(2) | R76MN3390(1)H3(2) |
| 400 | 250 | 0.4700 | 10.0 | 18.5 | 26.5 | 22.5 | 500 | 400,000 | 235 | 16 | 3 | 11.26 | 36 | 76MN3470(1)H3(2) | R76MN3470(1)H3(2) |
| 400 | 250 | 0.5600 | 11.0 | 20.0 | 26.5 | 22.5 | 500 | 400,000 | 280 | 16 | 3 | 12.62 | 34 | 76MN3560(1)H3(2) | R76MN3560(1)H3(2) |
| 400 | 250 | 0.6800 | 13.0 | 22.0 | 26.5 | 22.5 | 500 | 400,000 | 340 | 16 | 2 | 14.47 | 31 | 76MN3680(1)H3(2) | R76MN3680(1)H3(2) |
| 400 | 250 | 0.5600 | 11.0 | 20.0 | 32.0 | 27.5 | 300 | 240,000 | 168 | 18 | 11 | 6.56 | 31 | 76MR3560(1)H3(2) | R76MR3560(1)H3(2) |
| 400 | 250 | 0.6800 | 11.0 | 20.0 | 32.0 | 27.5 | 300 | 240,000 | 204 | 18 | 11 | 6.82 | 31 | 76MR3680(1)H3(2) | R76MR3680(1)H3(2) |
| 400 | 250 | 0.8200 | 13.0 | 22.0 | 32.0 | 27.5 | 300 | 240,000 | 246 | 18 | 9 | 7.78 | 29 | 76MR3820(1)H3(2) | R76MR3820(1)H3(2) |
| 400 | 250 | 1.0000 | 13.0 | 22.0 | 32.0 | 27.5 | 300 | 240,000 | 300 | 18 | 7 | 8.59 | 29 | 76MR4100(1)H4(2) | R76MR4100(1)H4(2) |
| 400 | 250 | 1.2000 | 14.0 | 28.0 | 32.0 | 27.5 | 300 | 240,000 | 360 | 18 | 16 | 6.09 | 26 | 76MR4120(1)H4(2) | R76MR4120(1)H4(2) |
| 400 | 250 | 1.5000 | 18.0 | 33.0 | 32.0 | 27.5 | 300 | 240,000 | 450 | 18 | 13 | 7.26 | 23 | 76MR4150(1)H3(2) | R76MR4150(1)H3(2) |
| 400 | 250 | 1.8000 | 18.0 | 33.0 | 32.0 | 27.5 | 300 | 240,000 | 540 | 18 | 11 | 7.95 | 23 | 76MR4180(1)H3(2) | R76MR4180(1)H3(2) |
| VDC | VAC | Cap Value | W | H | L | Lead Spacing (p) | dV/dt (V/µs) | Max K ₀ (V ² /µs) | A _{pk} | Lead Length 2x 4 mm | at 100 kHz | at 100 kHz, 100°C | (°C/W) | KEMET Internal Part Number | Customer Part Number |
| | | | | | | | | | I _{pk} | ESL | ESR | I _{rms} max (*) | R _{th} | | |

(1) Insert lead and packaging code. See Ordering Options Table for available options.

(2) H = 2.5% (only for C ≥ 1,000 pF), J = 5%, K = 10%

(*) I_{rms} value that leads to a ΔT of ≈ 15°C in the hot spot > T_{HS} = T_{AMB} + ΔT = 100°C + 15°C = 115°C

Table 1 – Ratings & Part Number Reference cont.

| VDC | VAC | Cap Value (µF) | Dimensions in mm | | | Lead Spacing (p) | dV/dt (V/µs) | Max K ₀ (V ² /µs) | I _{pk} | ESL | ESR | I _{rms} max (*) | R _{th} | KEMET Internal Part Number | Customer Part Number |
|-----|-----|----------------|---------------------|------------|-------------------|------------------|--------------|---|-----------------|---------------------|-----------------|--------------------------|-----------------|----------------------------|----------------------|
| | | | Lead Length 2x 4 mm | at 100 kHz | at 100 kHz, 100°C | | | | | R _{th} | | | | | |
| | | | | | | | | | | | A _{pk} | nH | mΩ | | |
| W | H | L | | | | | | | | | | | | | |
| 400 | 250 | 2.2000 | 22.0 | 37.0 | 32.0 | 27.5 | 300 | 240,000 | 660 | 18 | 9 | 9.24 | 21 | 76MR4220(1)H3(2) | R76MR4220(1)H3(2) |
| 400 | 250 | 2.7000 | 22.0 | 37.0 | 32.0 | 27.5 | 300 | 240,000 | 810 | 18 | 7 | 10.23 | 21 | 76MR4270(1)H3(2) | R76MR4270(1)H3(2) |
| 400 | 250 | 1.0000 | 11.0 | 22.0 | 41.5 | 37.5 | 180 | 144,000 | 180 | 20 | 7 | 8.90 | 27 | 76MW4100(1)H3(2) | R76MW4100(1)H3(2) |
| 400 | 250 | 1.0000 | 24.0 | 15.0 | 41.5 | 37.5 | 180 | 144,000 | 180 | 20 | 7 | 9.38 | 24 | 76MW4100(1)HL(2) | R76MW4100(1)HL(2) |
| 400 | 250 | 1.2000 | 13.0 | 24.0 | 41.5 | 37.5 | 180 | 144,000 | 216 | 20 | 16 | 6.19 | 25 | 76MW4120(1)H3(2) | R76MW4120(1)H3(2) |
| 400 | 250 | 1.2000 | 24.0 | 15.0 | 41.5 | 37.5 | 180 | 144,000 | 216 | 20 | 16 | 6.30 | 24 | 76MW4120(1)HL(2) | R76MW4120(1)HL(2) |
| 400 | 250 | 1.5000 | 13.0 | 24.0 | 41.5 | 37.5 | 180 | 144,000 | 270 | 20 | 13 | 6.92 | 25 | 76MW4150(1)H3(2) | R76MW4150(1)H3(2) |
| 400 | 250 | 1.5000 | 24.0 | 15.0 | 41.5 | 37.5 | 180 | 144,000 | 270 | 20 | 13 | 7.04 | 24 | 76MW4150(1)HL(2) | R76MW4150(1)HL(2) |
| 400 | 250 | 1.8000 | 16.0 | 28.5 | 41.5 | 37.5 | 180 | 144,000 | 324 | 20 | 11 | 8.02 | 23 | 76MW4180(1)H3(2) | R76MW4180(1)H3(2) |
| 400 | 250 | 1.8000 | 24.0 | 19.0 | 41.5 | 37.5 | 180 | 144,000 | 324 | 20 | 11 | 7.96 | 23 | 76MW4180(1)HL(2) | R76MW4180(1)HL(2) |
| 400 | 250 | 2.2000 | 19.0 | 32.0 | 41.5 | 37.5 | 180 | 144,000 | 396 | 20 | 9 | 9.26 | 21 | 76MW4220(1)H3(2) | R76MW4220(1)H3(2) |
| 400 | 250 | 2.2000 | 24.0 | 19.0 | 41.5 | 37.5 | 180 | 144,000 | 396 | 20 | 9 | 8.80 | 23 | 76MW4220(1)HL(2) | R76MW4220(1)HL(2) |
| 400 | 250 | 2.7000 | 19.0 | 32.0 | 41.5 | 37.5 | 180 | 144,000 | 486 | 20 | 7 | 10.26 | 21 | 76MW4270(1)H3(2) | R76MW4270(1)H3(2) |
| 400 | 250 | 3.3000 | 19.0 | 32.0 | 41.5 | 37.5 | 180 | 144,000 | 594 | 20 | 6 | 11.34 | 21 | 76MW4330(1)H3(2) | R76MW4330(1)H3(2) |
| 400 | 250 | 3.9000 | 20.0 | 40.0 | 41.5 | 37.5 | 180 | 144,000 | 702 | 20 | 5 | 12.94 | 19 | 76MW4390(1)H3(2) | R76MW4390(1)H3(2) |
| 400 | 250 | 4.7000 | 20.0 | 40.0 | 41.5 | 37.5 | 180 | 144,000 | 846 | 20 | 4 | 14.21 | 19 | 76MW4470(1)H3(2) | R76MW4470(1)H3(2) |
| 400 | 250 | 5.6000 | 24.0 | 44.0 | 41.5 | 37.5 | 180 | 144,000 | 1,008 | 20 | 3 | 16.18 | 17 | 76MW4560(1)H3(2) | R76MW4560(1)H3(2) |
| 400 | 250 | 6.8000 | 30.0 | 45.0 | 41.5 | 37.5 | 180 | 144,000 | 1,224 | 20 | 3 | 18.49 | 16 | 76MW4680(1)H3(2) | R76MW4680(1)H3(2) |
| 400 | 250 | 8.2000 | 30.0 | 45.0 | 41.5 | 37.5 | 180 | 144,000 | 1,476 | 20 | 2 | 20.30 | 16 | 76MW4820(1)H3(2) | R76MW4820(1)H3(2) |
| 630 | 400 | 0.0039 | 4.0 | 9.0 | 13.0 | 10.0 | 4,000 | 5,040,000 | 16 | 9 | 163 | 0.98 | 79 | 76PF1390(1)H0(2) | R76PF1390(1)H0(2) |
| 630 | 400 | 0.0047 | 4.0 | 9.0 | 13.0 | 10.0 | 4,000 | 5,040,000 | 19 | 9 | 135 | 1.18 | 79 | 76PF1470(1)H0(2) | R76PF1470(1)H0(2) |
| 630 | 400 | 0.0056 | 4.0 | 9.0 | 13.0 | 10.0 | 4,000 | 5,040,000 | 22 | 9 | 114 | 1.31 | 79 | 76PF1560(1)H0(2) | R76PF1560(1)H0(2) |
| 630 | 400 | 0.0068 | 4.0 | 9.0 | 13.0 | 10.0 | 4,000 | 5,040,000 | 27 | 9 | 94 | 1.45 | 79 | 76PF1680(1)H0(2) | R76PF1680(1)H0(2) |
| 630 | 400 | 0.0082 | 4.0 | 9.0 | 13.0 | 10.0 | 4,000 | 5,040,000 | 33 | 9 | 78 | 1.59 | 79 | 76PF1820(1)H0(2) | R76PF1820(1)H0(2) |
| 630 | 400 | 0.0100 | 5.0 | 11.0 | 13.0 | 10.0 | 4,000 | 5,040,000 | 40 | 9 | 64 | 1.87 | 69 | 76PF2100(1)H3(2) | R76PF2100(1)H3(2) |
| 630 | 400 | 0.0120 | 5.0 | 11.0 | 13.0 | 10.0 | 4,000 | 5,040,000 | 48 | 9 | 53 | 2.05 | 69 | 76PF2120(1)H3(2) | R76PF2120(1)H3(2) |
| 630 | 400 | 0.0150 | 6.0 | 12.0 | 13.0 | 10.0 | 4,000 | 5,040,000 | 60 | 9 | 42 | 2.38 | 64 | 76PF2150(1)H3(2) | R76PF2150(1)H3(2) |
| 630 | 400 | 0.0180 | 6.0 | 12.0 | 13.0 | 10.0 | 4,000 | 5,040,000 | 72 | 9 | 35 | 2.61 | 64 | 76PF2180(1)H3(2) | R76PF2180(1)H3(2) |
| 630 | 400 | 0.0120 | 5.0 | 11.0 | 18.0 | 15.0 | 3,000 | 3,780,000 | 36 | 10 | 53 | 2.19 | 60 | 76PI2120(1)H0(2) | R76PI2120(1)H0(2) |
| 630 | 400 | 0.0150 | 5.0 | 11.0 | 18.0 | 15.0 | 3,000 | 3,780,000 | 45 | 10 | 42 | 2.45 | 60 | 76PI2150(1)H0(2) | R76PI2150(1)H0(2) |
| 630 | 400 | 0.0180 | 5.0 | 11.0 | 18.0 | 15.0 | 3,000 | 3,780,000 | 54 | 10 | 35 | 2.69 | 60 | 76PI2180(1)H0(2) | R76PI2180(1)H0(2) |
| 630 | 400 | 0.0220 | 5.0 | 11.0 | 18.0 | 15.0 | 3,000 | 3,780,000 | 66 | 10 | 29 | 2.97 | 60 | 76PI2220(1)H3(2) | R76PI2220(1)H3(2) |
| 630 | 400 | 0.0270 | 5.0 | 11.0 | 18.0 | 15.0 | 3,000 | 3,780,000 | 81 | 10 | 24 | 3.29 | 60 | 76PI2270(1)H3(2) | R76PI2270(1)H3(2) |
| 630 | 400 | 0.0330 | 6.0 | 12.0 | 18.0 | 15.0 | 3,000 | 3,780,000 | 99 | 10 | 19 | 3.78 | 56 | 76PI2330(1)H3(2) | R76PI2330(1)H3(2) |
| 630 | 400 | 0.0390 | 6.0 | 12.0 | 18.0 | 15.0 | 3,000 | 3,780,000 | 117 | 10 | 16 | 4.10 | 56 | 76PI2390(1)H3(2) | R76PI2390(1)H3(2) |
| 630 | 400 | 0.0470 | 7.5 | 13.5 | 18.0 | 15.0 | 3,000 | 3,780,000 | 141 | 10 | 14 | 4.73 | 51 | 76PI2470(1)H3(2) | R76PI2470(1)H3(2) |
| 630 | 400 | 0.0470 | 9.0 | 12.5 | 18.0 | 15.0 | 3,000 | 3,780,000 | 141 | 10 | 14 | 4.78 | 50 | 76PI2470(1)H7(2) | R76PI2470(1)H7(2) |
| 630 | 400 | 0.0560 | 7.5 | 13.5 | 18.0 | 15.0 | 3,000 | 3,780,000 | 168 | 10 | 23 | 3.65 | 51 | 76PI2560(1)H3(2) | R76PI2560(1)H3(2) |
| 630 | 400 | 0.0560 | 9.0 | 12.5 | 18.0 | 15.0 | 3,000 | 3,780,000 | 168 | 10 | 23 | 3.69 | 50 | 76PI2560(1)H7(2) | R76PI2560(1)H7(2) |
| 630 | 400 | 0.0680 | 8.5 | 14.5 | 18.0 | 15.0 | 3,000 | 3,780,000 | 204 | 10 | 19 | 4.15 | 48 | 76PI2680(1)H3(2) | R76PI2680(1)H3(2) |
| 630 | 400 | 0.0680 | 9.0 | 12.5 | 18.0 | 15.0 | 3,000 | 3,780,000 | 204 | 10 | 19 | 4.07 | 50 | 76PI2680(1)H7(2) | R76PI2680(1)H7(2) |
| 630 | 400 | 0.0820 | 8.5 | 14.5 | 18.0 | 15.0 | 3,000 | 3,780,000 | 246 | 10 | 16 | 4.55 | 48 | 76PI2820(1)H3(2) | R76PI2820(1)H3(2) |
| 630 | 400 | 0.0820 | 13.0 | 12.0 | 18.0 | 15.0 | 3,000 | 3,780,000 | 246 | 10 | 16 | 4.70 | 45 | 76PI2820(1)H7(2) | R76PI2820(1)H7(2) |
| 630 | 400 | 0.1000 | 10.0 | 16.0 | 18.0 | 15.0 | 3,000 | 3,780,000 | 300 | 10 | 13 | 5.23 | 44 | 76PI3100(1)H3(2) | R76PI3100(1)H3(2) |
| 630 | 400 | 0.1200 | 11.0 | 19.0 | 18.0 | 15.0 | 3,000 | 3,780,000 | 360 | 10 | 13 | 5.37 | 40 | 76PI3120(1)H3(2) | R76PI3120(1)H3(2) |
| 630 | 400 | 0.0470 | 6.0 | 15.0 | 26.5 | 22.5 | 1,500 | 1,890,000 | 71 | 16 | 14 | 5.11 | 43 | 76PN2470(1)H0(2) | R76PN2470(1)H0(2) |
| 630 | 400 | 0.0560 | 6.0 | 15.0 | 26.5 | 22.5 | 1,500 | 1,890,000 | 84 | 16 | 23 | 3.95 | 43 | 76PN2560(1)H0(2) | R76PN2560(1)H0(2) |
| 630 | 400 | 0.0680 | 6.0 | 15.0 | 26.5 | 22.5 | 1,500 | 1,890,000 | 102 | 16 | 19 | 4.35 | 43 | 76PN2680(1)H0(2) | R76PN2680(1)H0(2) |
| 630 | 400 | 0.0820 | 6.0 | 15.0 | 26.5 | 22.5 | 1,500 | 1,890,000 | 123 | 16 | 16 | 4.78 | 43 | 76PN2820(1)H3(2) | R76PN2820(1)H3(2) |
| 630 | 400 | 0.1000 | 6.0 | 15.0 | 26.5 | 22.5 | 1,500 | 1,890,000 | 150 | 16 | 13 | 5.27 | 43 | 76PN3100(1)H3(2) | R76PN3100(1)H3(2) |
| 630 | 400 | 0.1200 | 7.0 | 16.0 | 26.5 | 22.5 | 1,500 | 1,890,000 | 180 | 16 | 13 | 5.32 | 41 | 76PN3120(1)H3(2) | R76PN3120(1)H3(2) |
| VDC | VAC | Cap Value | W | H | L | Lead Spacing (p) | dV/dt (V/µs) | Max K ₀ (V ² /µs) | A _{pk} | Lead Length 2x 4 mm | at 100 kHz | at 100 kHz, 100°C | (°C/W) | KEMET Internal Part Number | Customer Part Number |
| | | | | | | | | | I _{pk} | ESL | ESR | I _{rms} max (*) | R _{th} | | |

(1) Insert lead and packaging code. See Ordering Options Table for available options.

(2) H = 2.5% (only for C ≥ 1,000 pF), J = 5%, K = 10%

(*) I_{rms} value that leads to a ΔT of ≈ 15°C in the hot spot > T_{HS} = T_{AMB} + ΔT = 100°C + 15°C = 115°C

Table 1 – Ratings & Part Number Reference cont.

| VDC | VAC | Cap Value (µF) | Dimensions in mm | | | Lead Spacing (p) | dV/dt (V/µs) | Max K ₀ (V ² /µs) | I _{pk} | ESL | ESR | I _{rms} max (*) | R _{th} | KEMET Internal Part Number | Customer Part Number |
|------|-----|----------------|---------------------|------------|-------------------|------------------|--------------|---|-----------------|---------------------|-----------------|--------------------------|-----------------|----------------------------|----------------------|
| | | | Lead Length 2x 4 mm | at 100 kHz | at 100 kHz, 100°C | | | | | R _{th} | | | | | |
| | | | | | | | | | | | A _{pk} | nH | mΩ | | |
| W | H | L | | | | | | | | | | | | | |
| 630 | 400 | 0.1500 | 8.5 | 17.0 | 26.5 | 22.5 | 1,500 | 1,890,000 | 225 | 16 | 11 | 6.14 | 38 | 76PN3150(1)H3(2) | R76PN3150(1)H3(2) |
| 630 | 400 | 0.1800 | 8.5 | 17.0 | 26.5 | 22.5 | 1,500 | 1,890,000 | 270 | 16 | 9 | 6.73 | 38 | 76PN3180(1)H3(2) | R76PN3180(1)H3(2) |
| 630 | 400 | 0.2200 | 10.0 | 18.5 | 26.5 | 22.5 | 1,500 | 1,890,000 | 330 | 16 | 7 | 7.71 | 36 | 76PN3220(1)H3(2) | R76PN3220(1)H3(2) |
| 630 | 400 | 0.2700 | 11.0 | 20.0 | 26.5 | 22.5 | 1,500 | 1,890,000 | 405 | 16 | 6 | 8.77 | 34 | 76PN3270(1)H3(2) | R76PN3270(1)H3(2) |
| 630 | 400 | 0.3300 | 11.0 | 20.0 | 26.5 | 22.5 | 1,500 | 1,890,000 | 495 | 16 | 5 | 9.69 | 34 | 76PN3330(1)H3(2) | R76PN3330(1)H3(2) |
| 630 | 400 | 0.3900 | 13.0 | 22.0 | 26.5 | 22.5 | 1,500 | 1,890,000 | 585 | 16 | 4 | 10.96 | 31 | 76PN3390(1)H3(2) | R76PN3390(1)H3(2) |
| 630 | 400 | 0.3300 | 11.0 | 20.0 | 32.0 | 27.5 | 900 | 1,134,000 | 297 | 18 | 12 | 6.37 | 31 | 76PR3330(1)H4(2) | R76PR3330(1)H4(2) |
| 630 | 400 | 0.3900 | 11.0 | 20.0 | 32.0 | 27.5 | 900 | 1,134,000 | 351 | 18 | 16 | 5.48 | 31 | 76PR3390(1)H3(2) | R76PR3390(1)H3(2) |
| 630 | 400 | 0.4700 | 13.0 | 22.0 | 32.0 | 27.5 | 900 | 1,134,000 | 423 | 18 | 14 | 6.25 | 29 | 76PR3470(1)H3(2) | R76PR3470(1)H3(2) |
| 630 | 400 | 0.5600 | 13.0 | 22.0 | 32.0 | 27.5 | 900 | 1,134,000 | 504 | 18 | 11 | 6.82 | 29 | 76PR3560(1)H3(2) | R76PR3560(1)H3(2) |
| 630 | 400 | 0.6800 | 13.0 | 25.0 | 32.0 | 27.5 | 900 | 1,134,000 | 612 | 18 | 11 | 7.26 | 28 | 76PR3680(1)H4(2) | R76PR3680(1)H4(2) |
| 630 | 400 | 0.8200 | 14.0 | 28.0 | 32.0 | 27.5 | 900 | 1,134,000 | 738 | 18 | 9 | 8.22 | 26 | 76PR3820(1)H3(2) | R76PR3820(1)H3(2) |
| 630 | 400 | 1.0000 | 18.0 | 33.0 | 32.0 | 27.5 | 900 | 1,134,000 | 900 | 18 | 7 | 9.67 | 23 | 76PR4100(1)H3(2) | R76PR4100(1)H3(2) |
| 630 | 400 | 1.2000 | 18.0 | 33.0 | 32.0 | 27.5 | 900 | 1,134,000 | 1,080 | 18 | 16 | 6.49 | 23 | 76PR4120(1)H3(2) | R76PR4120(1)H3(2) |
| 630 | 400 | 1.5000 | 22.0 | 37.0 | 32.0 | 27.5 | 900 | 1,134,000 | 1,350 | 18 | 13 | 7.63 | 21 | 76PR4150(1)H3(2) | R76PR4150(1)H3(2) |
| 630 | 400 | 1.8000 | 22.0 | 37.0 | 32.0 | 27.5 | 900 | 1,134,000 | 1,620 | 18 | 11 | 8.36 | 21 | 76PR4180(1)H3(2) | R76PR4180(1)H3(2) |
| 630 | 400 | 0.3300 | 11.0 | 22.0 | 41.5 | 37.5 | 450 | 567,000 | 149 | 20 | 12 | 6.86 | 27 | 76PW3330(1)H3(2) | R76PW3330(1)H3(2) |
| 630 | 400 | 0.3900 | 11.0 | 22.0 | 41.5 | 37.5 | 450 | 567,000 | 176 | 20 | 16 | 5.90 | 27 | 76PW3390(1)H3(2) | R76PW3390(1)H3(2) |
| 630 | 400 | 0.4700 | 11.0 | 22.0 | 41.5 | 37.5 | 450 | 567,000 | 212 | 20 | 14 | 6.47 | 27 | 76PW3470(1)H3(2) | R76PW3470(1)H3(2) |
| 630 | 400 | 0.5600 | 11.0 | 22.0 | 41.5 | 37.5 | 450 | 567,000 | 252 | 20 | 11 | 7.06 | 27 | 76PW3560(1)H3(2) | R76PW3560(1)H3(2) |
| 630 | 400 | 0.6800 | 11.0 | 22.0 | 41.5 | 37.5 | 450 | 567,000 | 306 | 20 | 11 | 7.34 | 27 | 76PW3680(1)H3(2) | R76PW3680(1)H3(2) |
| 630 | 400 | 0.6800 | 24.0 | 15.0 | 41.5 | 37.5 | 450 | 567,000 | 306 | 20 | 11 | 7.74 | 24 | 76PW3680(1)HL(2) | R76PW3680(1)HL(2) |
| 630 | 400 | 0.8200 | 13.0 | 24.0 | 41.5 | 37.5 | 450 | 567,000 | 369 | 20 | 9 | 8.35 | 25 | 76PW3820(1)H3(2) | R76PW3820(1)H3(2) |
| 630 | 400 | 0.8200 | 24.0 | 15.0 | 41.5 | 37.5 | 450 | 567,000 | 369 | 20 | 9 | 8.50 | 24 | 76PW3820(1)HL(2) | R76PW3820(1)HL(2) |
| 630 | 400 | 1.0000 | 16.0 | 28.5 | 41.5 | 37.5 | 450 | 567,000 | 450 | 20 | 7 | 9.76 | 23 | 76PW4100(1)H3(2) | R76PW4100(1)H3(2) |
| 630 | 400 | 1.0000 | 24.0 | 15.0 | 41.5 | 37.5 | 450 | 567,000 | 450 | 20 | 7 | 9.38 | 24 | 76PW4100(1)HL(2) | R76PW4100(1)HL(2) |
| 630 | 400 | 1.2000 | 16.0 | 28.5 | 41.5 | 37.5 | 450 | 567,000 | 540 | 20 | 16 | 6.55 | 23 | 76PW4120(1)H3(2) | R76PW4120(1)H3(2) |
| 630 | 400 | 1.2000 | 24.0 | 19.0 | 41.5 | 37.5 | 450 | 567,000 | 540 | 20 | 16 | 6.50 | 23 | 76PW4120(1)HL(2) | R76PW4120(1)HL(2) |
| 630 | 400 | 1.5000 | 16.0 | 28.5 | 41.5 | 37.5 | 450 | 567,000 | 675 | 20 | 13 | 7.32 | 23 | 76PW4150(1)H3(2) | R76PW4150(1)H3(2) |
| 630 | 400 | 1.5000 | 24.0 | 19.0 | 41.5 | 37.5 | 450 | 567,000 | 675 | 20 | 13 | 7.27 | 23 | 76PW4150(1)HL(2) | R76PW4150(1)HL(2) |
| 630 | 400 | 1.8000 | 19.0 | 32.0 | 41.5 | 37.5 | 450 | 567,000 | 810 | 20 | 11 | 8.37 | 21 | 76PW4180(1)H3(2) | R76PW4180(1)H3(2) |
| 630 | 400 | 2.2000 | 20.0 | 40.0 | 41.5 | 37.5 | 450 | 567,000 | 990 | 20 | 9 | 9.72 | 19 | 76PW4220(1)H3(2) | R76PW4220(1)H3(2) |
| 630 | 400 | 2.7000 | 20.0 | 40.0 | 41.5 | 37.5 | 450 | 567,000 | 1,215 | 20 | 7 | 10.77 | 19 | 76PW4270(1)H3(2) | R76PW4270(1)H3(2) |
| 630 | 400 | 3.3000 | 24.0 | 44.0 | 41.5 | 37.5 | 450 | 567,000 | 1,485 | 20 | 6 | 12.42 | 17 | 76PW4330(1)H3(2) | R76PW4330(1)H3(2) |
| 630 | 400 | 3.9000 | 30.0 | 45.0 | 41.5 | 37.5 | 450 | 567,000 | 1,755 | 20 | 5 | 14.00 | 16 | 76PW4390(1)H3(2) | R76PW4390(1)H3(2) |
| 1000 | 600 | 0.00047 | 4.0 | 9.0 | 13.0 | 10.0 | 6,500 | 13,000,000 | 3 | 9 | 1,355 | 0.18 | 79 | 76QF0470(1)H0(2) | R76QF0470(1)H0(2) |
| 1000 | 600 | 0.00056 | 4.0 | 9.0 | 13.0 | 10.0 | 6,500 | 13,000,000 | 4 | 9 | 1,137 | 0.21 | 79 | 76QF0560(1)H0(2) | R76QF0560(1)H0(2) |
| 1000 | 600 | 0.00068 | 4.0 | 9.0 | 13.0 | 10.0 | 6,500 | 13,000,000 | 4 | 9 | 936 | 0.26 | 79 | 76QF0680(1)H0(2) | R76QF0680(1)H0(2) |
| 1000 | 600 | 0.00082 | 4.0 | 9.0 | 13.0 | 10.0 | 6,500 | 13,000,000 | 5 | 9 | 776 | 0.31 | 79 | 76QF0820(1)H0(2) | R76QF0820(1)H0(2) |
| 1000 | 600 | 0.0010 | 4.0 | 9.0 | 13.0 | 10.0 | 6,500 | 13,000,000 | 7 | 9 | 637 | 0.38 | 79 | 76QF1100(1)H0(2) | R76QF1100(1)H0(2) |
| 1000 | 600 | 0.0012 | 4.0 | 9.0 | 13.0 | 10.0 | 6,500 | 13,000,000 | 8 | 9 | 531 | 0.45 | 79 | 76QF1120(1)H0(2) | R76QF1120(1)H0(2) |
| 1000 | 600 | 0.0015 | 4.0 | 9.0 | 13.0 | 10.0 | 6,500 | 13,000,000 | 10 | 9 | 424 | 0.57 | 79 | 76QF1150(1)H0(2) | R76QF1150(1)H0(2) |
| 1000 | 600 | 0.0018 | 4.0 | 9.0 | 13.0 | 10.0 | 6,500 | 13,000,000 | 12 | 9 | 354 | 0.68 | 79 | 76QF1180(1)H0(2) | R76QF1180(1)H0(2) |
| 1000 | 600 | 0.0022 | 4.0 | 9.0 | 13.0 | 10.0 | 6,500 | 13,000,000 | 14 | 9 | 289 | 0.82 | 79 | 76QF1220(1)H0(2) | R76QF1220(1)H0(2) |
| 1000 | 600 | 0.0027 | 4.0 | 9.0 | 13.0 | 10.0 | 6,500 | 13,000,000 | 18 | 9 | 236 | 0.91 | 79 | 76QF1270(1)H0(2) | R76QF1270(1)H0(2) |
| 1000 | 600 | 0.0033 | 4.0 | 9.0 | 13.0 | 10.0 | 6,500 | 13,000,000 | 21 | 9 | 193 | 1.01 | 79 | 76QF1330(1)H3(2) | R76QF1330(1)H3(2) |
| 1000 | 600 | 0.0039 | 5.0 | 11.0 | 13.0 | 10.0 | 6,500 | 13,000,000 | 25 | 9 | 163 | 1.17 | 69 | 76QF1390(1)H3(2) | R76QF1390(1)H3(2) |
| 1000 | 600 | 0.0047 | 5.0 | 11.0 | 13.0 | 10.0 | 6,500 | 13,000,000 | 31 | 9 | 135 | 1.28 | 69 | 76QF1470(1)H3(2) | R76QF1470(1)H3(2) |
| 1000 | 600 | 0.0056 | 6.0 | 12.0 | 13.0 | 10.0 | 6,500 | 13,000,000 | 36 | 9 | 114 | 1.46 | 64 | 76QF1560(1)H3(2) | R76QF1560(1)H3(2) |
| 1000 | 600 | 0.0068 | 6.0 | 12.0 | 13.0 | 10.0 | 6,500 | 13,000,000 | 44 | 9 | 94 | 1.60 | 64 | 76QF1680(1)H3(2) | R76QF1680(1)H3(2) |
| 1000 | 600 | 0.0082 | 4.0 | 10.0 | 18.0 | 15.0 | 3,500 | 7,000,000 | 29 | 10 | 78 | 1.74 | 65 | 76QI1820(1)H4(2) | R76QI1820(1)H4(2) |
| VDC | VAC | Cap Value | W | H | L | Lead Spacing (p) | dV/dt (V/µs) | Max K ₀ (V ² /µs) | A _{pk} | Lead Length 2x 4 mm | at 100 kHz | at 100 kHz, 100°C | (°C/W) | KEMET Internal Part Number | Customer Part Number |
| | | | | | | | | | I _{pk} | ESL | ESR | I _{rms} max (*) | R _{th} | | |

(1) Insert lead and packaging code. See Ordering Options Table for available options.

(2) H = 2.5% (only for C ≥ 1,000 pF), J = 5%, K = 10%

(*) I_{rms} value that leads to a ΔT of ≈ 15°C in the hot spot > T_{HS} = T_{AMB} + ΔT = 100°C + 15°C = 115°C

Table 1 – Ratings & Part Number Reference cont.

| VDC | VAC | Cap Value (µF) | Dimensions in mm | | | Lead Spacing (p) | dV/dt (V/µs) | Max K ₀ (V ² /µs) | I _{pk} | ESL | ESR | I _{rms} max (*) | R _{th} | KEMET Internal Part Number | Customer Part Number |
|------|-----|----------------|---------------------|------------|-------------------|------------------|--------------|---|-----------------|---------------------|-----------------|--------------------------|-----------------|----------------------------|----------------------|
| | | | Lead Length 2x 4 mm | at 100 kHz | at 100 kHz, 100°C | | | | | R _{th} | | | | | |
| | | | | | | | | | | | A _{pk} | nH | mΩ | | |
| W | H | L | | | | | | | | | | | | | |
| 1000 | 600 | 0.0082 | 5.0 | 11.0 | 18.0 | 15.0 | 3,500 | 7,000,000 | 29 | 10 | 78 | 1.81 | 60 | 76Q11820(1)H0(2) | R76Q11820(1)H0(2) |
| 1000 | 600 | 0.0100 | 4.0 | 10.0 | 18.0 | 15.0 | 3,500 | 7,000,000 | 35 | 10 | 64 | 1.92 | 65 | 76Q12100(1)H4(2) | R76Q12100(1)H4(2) |
| 1000 | 600 | 0.0100 | 5.0 | 11.0 | 18.0 | 15.0 | 3,500 | 7,000,000 | 35 | 10 | 64 | 2.00 | 60 | 76Q12100(1)H3(2) | R76Q12100(1)H3(2) |
| 1000 | 600 | 0.0120 | 5.0 | 11.0 | 18.0 | 15.0 | 3,500 | 7,000,000 | 42 | 10 | 53 | 2.19 | 60 | 76Q12120(1)H3(2) | R76Q12120(1)H3(2) |
| 1000 | 600 | 0.0150 | 5.0 | 11.0 | 18.0 | 15.0 | 3,500 | 7,000,000 | 53 | 10 | 42 | 2.45 | 60 | 76Q12150(1)H4(2) | R76Q12150(1)H4(2) |
| 1000 | 600 | 0.0180 | 5.0 | 11.0 | 18.0 | 15.0 | 3,500 | 7,000,000 | 63 | 10 | 35 | 2.69 | 60 | 76Q12180(1)H4(2) | R76Q12180(1)H4(2) |
| 1000 | 600 | 0.0220 | 6.0 | 12.0 | 18.0 | 15.0 | 3,500 | 7,000,000 | 77 | 10 | 29 | 3.08 | 56 | 76Q12220(1)H4(2) | R76Q12220(1)H4(2) |
| 1000 | 600 | 0.0220 | 9.0 | 12.5 | 18.0 | 15.0 | 3,500 | 7,000,000 | 77 | 10 | 29 | 3.27 | 50 | 76Q12220(1)H7(2) | R76Q12220(1)H7(2) |
| 1000 | 600 | 0.0270 | 7.5 | 13.5 | 18.0 | 15.0 | 3,500 | 7,000,000 | 95 | 10 | 24 | 3.59 | 51 | 76Q12270(1)H4(2) | R76Q12270(1)H4(2) |
| 1000 | 600 | 0.0270 | 9.0 | 12.5 | 18.0 | 15.0 | 3,500 | 7,000,000 | 95 | 10 | 24 | 3.63 | 50 | 76Q12270(1)H7(2) | R76Q12270(1)H7(2) |
| 1000 | 600 | 0.0330 | 7.5 | 13.5 | 18.0 | 15.0 | 3,500 | 7,000,000 | 116 | 10 | 19 | 3.97 | 51 | 76Q12330(1)H4(2) | R76Q12330(1)H4(2) |
| 1000 | 600 | 0.0330 | 13.0 | 12.0 | 18.0 | 15.0 | 3,500 | 7,000,000 | 116 | 10 | 19 | 4.21 | 45 | 76Q12330(1)H7(2) | R76Q12330(1)H7(2) |
| 1000 | 600 | 0.0390 | 8.5 | 14.5 | 18.0 | 15.0 | 3,500 | 7,000,000 | 137 | 10 | 16 | 4.44 | 48 | 76Q12390(1)H4(2) | R76Q12390(1)H4(2) |
| 1000 | 600 | 0.0470 | 8.5 | 14.5 | 18.0 | 15.0 | 3,500 | 7,000,000 | 165 | 10 | 14 | 4.88 | 48 | 76Q12470(1)H4(2) | R76Q12470(1)H4(2) |
| 1000 | 600 | 0.0270 | 6.0 | 15.0 | 26.5 | 22.5 | 2,100 | 4,200,000 | 57 | 16 | 24 | 3.88 | 43 | 76QN2270(1)H0(2) | R76QN2270(1)H0(2) |
| 1000 | 600 | 0.0330 | 6.0 | 15.0 | 26.5 | 22.5 | 2,100 | 4,200,000 | 69 | 16 | 19 | 4.28 | 43 | 76QN2330(1)H3(2) | R76QN2330(1)H3(2) |
| 1000 | 600 | 0.0390 | 6.0 | 15.0 | 26.5 | 22.5 | 2,100 | 4,200,000 | 82 | 16 | 16 | 4.66 | 43 | 76QN2390(1)H3(2) | R76QN2390(1)H3(2) |
| 1000 | 600 | 0.0470 | 7.0 | 16.0 | 26.5 | 22.5 | 2,100 | 4,200,000 | 99 | 16 | 14 | 5.26 | 41 | 76QN2470(1)H3(2) | R76QN2470(1)H3(2) |
| 1000 | 600 | 0.0560 | 7.0 | 16.0 | 26.5 | 22.5 | 2,100 | 4,200,000 | 118 | 16 | 23 | 4.06 | 41 | 76QN2560(1)H3(2) | R76QN2560(1)H3(2) |
| 1000 | 600 | 0.0680 | 8.5 | 17.0 | 26.5 | 22.5 | 2,100 | 4,200,000 | 143 | 16 | 19 | 4.62 | 38 | 76QN2680(1)H3(2) | R76QN2680(1)H3(2) |
| 1000 | 600 | 0.0820 | 10.0 | 18.5 | 26.5 | 22.5 | 2,100 | 4,200,000 | 172 | 16 | 16 | 5.26 | 36 | 76QN2820(1)H3(2) | R76QN2820(1)H3(2) |
| 1000 | 600 | 0.1000 | 10.0 | 18.5 | 26.5 | 22.5 | 2,100 | 4,200,000 | 210 | 16 | 13 | 5.81 | 36 | 76QN3100(1)H3(2) | R76QN3100(1)H3(2) |
| 1000 | 600 | 0.1200 | 11.0 | 20.0 | 26.5 | 22.5 | 2,100 | 4,200,000 | 252 | 16 | 13 | 5.84 | 34 | 76QN3120(1)H3(2) | R76QN3120(1)H3(2) |
| 1000 | 600 | 0.1500 | 13.0 | 22.0 | 26.5 | 22.5 | 2,100 | 4,200,000 | 315 | 16 | 11 | 6.80 | 31 | 76QN3150(1)H3(2) | R76QN3150(1)H3(2) |
| 1000 | 600 | 0.1500 | 11.0 | 20.0 | 32.0 | 27.5 | 1,000 | 2,000,000 | 150 | 18 | 21 | 4.80 | 31 | 76QR3150(1)H3(2) | R76QR3150(1)H3(2) |
| 1000 | 600 | 0.1800 | 13.0 | 22.0 | 32.0 | 27.5 | 1,000 | 2,000,000 | 180 | 18 | 18 | 5.47 | 29 | 76QR3180(1)H3(2) | R76QR3180(1)H3(2) |
| 1000 | 600 | 0.2200 | 13.0 | 22.0 | 32.0 | 27.5 | 1,000 | 2,000,000 | 220 | 18 | 14 | 6.05 | 29 | 76QR3220(1)H3(2) | R76QR3220(1)H3(2) |
| 1000 | 600 | 0.2700 | 13.0 | 25.0 | 32.0 | 27.5 | 1,000 | 2,000,000 | 270 | 18 | 15 | 6.13 | 28 | 76QR3270(1)H4(2) | R76QR3270(1)H4(2) |
| 1000 | 600 | 0.3300 | 14.0 | 28.0 | 32.0 | 27.5 | 1,000 | 2,000,000 | 330 | 18 | 12 | 6.99 | 26 | 76QR3330(1)H3(2) | R76QR3330(1)H3(2) |
| 1000 | 600 | 0.3900 | 18.0 | 33.0 | 32.0 | 27.5 | 1,000 | 2,000,000 | 390 | 18 | 16 | 6.41 | 23 | 76QR3390(1)H3(2) | R76QR3390(1)H3(2) |
| 1000 | 600 | 0.4700 | 18.0 | 33.0 | 32.0 | 27.5 | 1,000 | 2,000,000 | 470 | 18 | 14 | 7.03 | 23 | 76QR3470(1)H3(2) | R76QR3470(1)H3(2) |
| 1000 | 600 | 0.5600 | 22.0 | 37.0 | 32.0 | 27.5 | 1,000 | 2,000,000 | 560 | 18 | 11 | 8.07 | 21 | 76QR3560(1)H3(2) | R76QR3560(1)H3(2) |
| 1000 | 600 | 0.6800 | 22.0 | 37.0 | 32.0 | 27.5 | 1,000 | 2,000,000 | 680 | 18 | 11 | 8.39 | 21 | 76QR3680(1)H3(2) | R76QR3680(1)H3(2) |
| 1000 | 600 | 0.1800 | 11.0 | 22.0 | 41.5 | 37.5 | 500 | 1,000,000 | 90 | 20 | 18 | 5.66 | 27 | 76QW3180(1)H3(2) | R76QW3180(1)H3(2) |
| 1000 | 600 | 0.2200 | 11.0 | 22.0 | 41.5 | 37.5 | 500 | 1,000,000 | 110 | 20 | 14 | 6.26 | 27 | 76QW3220(1)H3(2) | R76QW3220(1)H3(2) |
| 1000 | 600 | 0.2700 | 13.0 | 24.0 | 41.5 | 37.5 | 500 | 1,000,000 | 135 | 20 | 15 | 6.43 | 25 | 76QW3270(1)H3(2) | R76QW3270(1)H3(2) |
| 1000 | 600 | 0.2700 | 24.0 | 15.0 | 41.5 | 37.5 | 500 | 1,000,000 | 135 | 20 | 15 | 6.54 | 24 | 76QW3270(1)HL(2) | R76QW3270(1)HL(2) |
| 1000 | 600 | 0.3300 | 13.0 | 24.0 | 41.5 | 37.5 | 500 | 1,000,000 | 165 | 20 | 12 | 7.11 | 25 | 76QW3330(1)H3(2) | R76QW3330(1)H3(2) |
| 1000 | 600 | 0.3300 | 24.0 | 15.0 | 41.5 | 37.5 | 500 | 1,000,000 | 165 | 20 | 12 | 7.23 | 24 | 76QW3330(1)HL(2) | R76QW3330(1)HL(2) |
| 1000 | 600 | 0.3900 | 16.0 | 28.5 | 41.5 | 37.5 | 500 | 1,000,000 | 195 | 20 | 16 | 6.46 | 23 | 76QW3390(1)H3(2) | R76QW3390(1)H3(2) |
| 1000 | 600 | 0.3900 | 24.0 | 15.0 | 41.5 | 37.5 | 500 | 1,000,000 | 195 | 20 | 16 | 6.22 | 24 | 76QW3390(1)HL(2) | R76QW3390(1)HL(2) |
| 1000 | 600 | 0.4700 | 16.0 | 28.5 | 41.5 | 37.5 | 500 | 1,000,000 | 235 | 20 | 14 | 7.10 | 23 | 76QW3470(1)H3(2) | R76QW3470(1)H3(2) |
| 1000 | 600 | 0.4700 | 24.0 | 19.0 | 41.5 | 37.5 | 500 | 1,000,000 | 235 | 20 | 14 | 7.05 | 23 | 76QW3470(1)HL(2) | R76QW3470(1)HL(2) |
| 1000 | 600 | 0.5600 | 16.0 | 28.5 | 41.5 | 37.5 | 500 | 1,000,000 | 280 | 20 | 11 | 7.75 | 23 | 76QW3560(1)H3(2) | R76QW3560(1)H3(2) |
| 1000 | 600 | 0.5600 | 24.0 | 19.0 | 41.5 | 37.5 | 500 | 1,000,000 | 280 | 20 | 11 | 7.69 | 23 | 76QW3560(1)HL(2) | R76QW3560(1)HL(2) |
| 1000 | 600 | 0.6800 | 19.0 | 32.0 | 41.5 | 37.5 | 500 | 1,000,000 | 340 | 20 | 11 | 8.40 | 21 | 76QW3680(1)H3(2) | R76QW3680(1)H3(2) |
| 1000 | 600 | 0.8200 | 20.0 | 40.0 | 41.5 | 37.5 | 500 | 1,000,000 | 410 | 20 | 9 | 9.69 | 19 | 76QW3820(1)H3(2) | R76QW3820(1)H3(2) |
| 1000 | 600 | 1.0000 | 20.0 | 40.0 | 41.5 | 37.5 | 500 | 1,000,000 | 500 | 20 | 7 | 10.70 | 19 | 76QW4100(1)H3(2) | R76QW4100(1)H3(2) |
| 1000 | 600 | 1.2000 | 24.0 | 44.0 | 41.5 | 37.5 | 500 | 1,000,000 | 600 | 20 | 16 | 7.49 | 17 | 76QW4120(1)H3(2) | R76QW4120(1)H3(2) |
| 1000 | 600 | 1.5000 | 24.0 | 44.0 | 41.5 | 37.5 | 500 | 1,000,000 | 750 | 20 | 13 | 8.37 | 17 | 76QW4150(1)H3(2) | R76QW4150(1)H3(2) |
| 1000 | 600 | 2.2000 | 24.0 | 44.0 | 41.5 | 37.5 | 500 | 1,000,000 | 1,100 | 20 | 9 | 10.14 | 17 | 76QW4220(1)H3(2) | R76QW4220(1)H3(2) |
| VDC | VAC | Cap Value | W | H | L | Lead Spacing (p) | dV/dt (V/µs) | Max K ₀ (V ² /µs) | A _{pk} | Lead Length 2x 4 mm | at 100 kHz | at 100 kHz, 100°C | (°C/W) | KEMET Internal Part Number | Customer Part Number |
| | | | | | | | | | I _{pk} | ESL | ESR | I _{rms} max (*) | R _{th} | | |

(1) Insert lead and packaging code. See Ordering Options Table for available options.

(2) H = 2.5% (only for C ≥ 1,000 pF), J = 5%, K = 10%

(*) I_{rms} value that leads to a ΔT of ≈ 15°C in the hot spot > T_{HS} = T_{AMB} + ΔT = 100°C + 15°C = 115°C

Table 1 – Ratings & Part Number Reference cont.

| VDC | VAC | Cap Value (µF) | Dimensions in mm | | | Lead Spacing (p) | dV/dt (V/µs) | Max K ₀ (V ² /µs) | I _{pk} | ESL | ESR | I _{rms} max (*) | R _{th} | KEMET Internal Part Number | Customer Part Number |
|------|-----|----------------|------------------|--------------|---|------------------|---------------------|---|--------------------------|---------------------|----------------------------|--------------------------|-----------------|----------------------------|----------------------|
| | | | | | | | | | | Lead Length 2x 4 mm | at 100 kHz | at 100 kHz, 100°C | (°C/W) | | |
| | | | A _{pk} | nH | mΩ | | | | A _{rms} | (°C/W) | | | | | |
| W | H | L | Lead Spacing (p) | dV/dt (V/µs) | Max K ₀ (V ² /µs) | A _{pk} | Lead Length 2x 4 mm | at 100 kHz | I _{rms} max (*) | R _{th} | KEMET Internal Part Number | Customer Part Number | | | |
| 1600 | 650 | 0.0033 | 4.0 | 10.0 | 18.0 | 15.0 | 6,000 | 19,200,000 | 20 | 10 | 193 | 1.10 | 65 | 76T11330(1)H4(2) | R76T11330(1)H4(2) |
| 1600 | 650 | 0.0033 | 5.0 | 11.0 | 18.0 | 15.0 | 6,000 | 19,200,000 | 20 | 10 | 193 | 1.15 | 60 | 76T11330(1)H3(2) | R76T11330(1)H3(2) |
| 1600 | 650 | 0.0039 | 4.0 | 10.0 | 18.0 | 15.0 | 6,000 | 19,200,000 | 23 | 10 | 163 | 1.20 | 65 | 76T11390(1)H4(2) | R76T11390(1)H4(2) |
| 1600 | 650 | 0.0039 | 5.0 | 11.0 | 18.0 | 15.0 | 6,000 | 19,200,000 | 23 | 10 | 163 | 1.25 | 60 | 76T11390(1)H3(2) | R76T11390(1)H3(2) |
| 1600 | 650 | 0.0047 | 4.0 | 10.0 | 18.0 | 15.0 | 6,000 | 19,200,000 | 28 | 10 | 135 | 1.32 | 65 | 76T11470(1)H4(2) | R76T11470(1)H4(2) |
| 1600 | 650 | 0.0047 | 5.0 | 11.0 | 18.0 | 15.0 | 6,000 | 19,200,000 | 28 | 10 | 135 | 1.37 | 60 | 76T11470(1)H3(2) | R76T11470(1)H3(2) |
| 1600 | 650 | 0.0056 | 4.0 | 10.0 | 18.0 | 15.0 | 6,000 | 19,200,000 | 34 | 10 | 114 | 1.44 | 65 | 76T11560(1)H4(2) | R76T11560(1)H4(2) |
| 1600 | 650 | 0.0056 | 5.0 | 11.0 | 18.0 | 15.0 | 6,000 | 19,200,000 | 34 | 10 | 114 | 1.50 | 60 | 76T11560(1)H3(2) | R76T11560(1)H3(2) |
| 1600 | 650 | 0.0068 | 5.0 | 11.0 | 18.0 | 15.0 | 6,000 | 19,200,000 | 41 | 10 | 94 | 1.65 | 60 | 76T11680(1)H3(2) | R76T11680(1)H3(2) |
| 1600 | 650 | 0.0082 | 5.0 | 11.0 | 18.0 | 15.0 | 6,000 | 19,200,000 | 49 | 10 | 78 | 1.81 | 60 | 76T11820(1)H4(2) | R76T11820(1)H4(2) |
| 1600 | 650 | 0.0100 | 5.0 | 11.0 | 18.0 | 15.0 | 6,000 | 19,200,000 | 60 | 10 | 64 | 2.00 | 60 | 76T12100(1)H4(2) | R76T12100(1)H4(2) |
| 1600 | 650 | 0.0120 | 6.0 | 12.0 | 18.0 | 15.0 | 6,000 | 19,200,000 | 72 | 10 | 53 | 2.28 | 56 | 76T12120(1)H4(2) | R76T12120(1)H4(2) |
| 1600 | 650 | 0.0150 | 6.0 | 12.0 | 18.0 | 15.0 | 6,000 | 19,200,000 | 90 | 10 | 42 | 2.55 | 56 | 76T12150(1)H4(2) | R76T12150(1)H4(2) |
| 1600 | 650 | 0.0180 | 7.5 | 13.5 | 18.0 | 15.0 | 6,000 | 19,200,000 | 108 | 10 | 35 | 2.93 | 51 | 76T12180(1)H4(2) | R76T12180(1)H4(2) |
| 1600 | 650 | 0.0180 | 9.0 | 12.5 | 18.0 | 15.0 | 6,000 | 19,200,000 | 108 | 10 | 35 | 2.96 | 50 | 76T12180(1)H7(2) | R76T12180(1)H7(2) |
| 1600 | 650 | 0.0220 | 7.5 | 13.5 | 18.0 | 15.0 | 6,000 | 19,200,000 | 132 | 10 | 29 | 3.24 | 51 | 76T12220(1)H4(2) | R76T12220(1)H4(2) |
| 1600 | 650 | 0.0220 | 13.0 | 12.0 | 18.0 | 15.0 | 6,000 | 19,200,000 | 132 | 10 | 29 | 3.44 | 45 | 76T12220(1)H7(2) | R76T12220(1)H7(2) |
| 1600 | 650 | 0.0270 | 8.5 | 14.5 | 18.0 | 15.0 | 6,000 | 19,200,000 | 162 | 10 | 24 | 3.69 | 48 | 76T12270(1)H4(2) | R76T12270(1)H4(2) |
| 1600 | 650 | 0.0330 | 8.5 | 14.5 | 18.0 | 15.0 | 6,000 | 19,200,000 | 198 | 10 | 19 | 4.08 | 48 | 76T12330(1)H4(2) | R76T12330(1)H4(2) |
| 1600 | 650 | 0.0150 | 6.0 | 15.0 | 26.5 | 22.5 | 3,000 | 9,600,000 | 45 | 16 | 42 | 2.89 | 43 | 76TN2150(1)H3(2) | R76TN2150(1)H3(2) |
| 1600 | 650 | 0.0180 | 6.0 | 15.0 | 26.5 | 22.5 | 3,000 | 9,600,000 | 54 | 16 | 35 | 3.16 | 43 | 76TN2180(1)H3(2) | R76TN2180(1)H3(2) |
| 1600 | 650 | 0.0220 | 6.0 | 15.0 | 26.5 | 22.5 | 3,000 | 9,600,000 | 66 | 16 | 29 | 3.50 | 43 | 76TN2220(1)H3(2) | R76TN2220(1)H3(2) |
| 1600 | 650 | 0.0270 | 6.0 | 15.0 | 26.5 | 22.5 | 3,000 | 9,600,000 | 81 | 16 | 24 | 3.88 | 43 | 76TN2270(1)H3(2) | R76TN2270(1)H3(2) |
| 1600 | 650 | 0.0330 | 6.0 | 15.0 | 26.5 | 22.5 | 3,000 | 9,600,000 | 99 | 16 | 19 | 4.28 | 43 | 76TN2330(1)H4(2) | R76TN2330(1)H4(2) |
| 1600 | 650 | 0.0390 | 7.0 | 16.0 | 26.5 | 22.5 | 3,000 | 9,600,000 | 117 | 16 | 16 | 4.79 | 41 | 76TN2390(1)H4(2) | R76TN2390(1)H4(2) |
| 1600 | 650 | 0.0470 | 7.0 | 16.0 | 26.5 | 22.5 | 3,000 | 9,600,000 | 141 | 16 | 14 | 5.26 | 41 | 76TN2470(1)H4(2) | R76TN2470(1)H4(2) |
| 1600 | 650 | 0.0560 | 8.5 | 17.0 | 26.5 | 22.5 | 3,000 | 9,600,000 | 168 | 16 | 23 | 4.20 | 38 | 76TN2560(1)H4(2) | R76TN2560(1)H4(2) |
| 1600 | 650 | 0.0680 | 10.0 | 18.5 | 26.5 | 22.5 | 3,000 | 9,600,000 | 204 | 16 | 19 | 4.79 | 36 | 76TN2680(1)H4(2) | R76TN2680(1)H4(2) |
| 1600 | 650 | 0.0820 | 10.0 | 18.5 | 26.5 | 22.5 | 3,000 | 9,600,000 | 246 | 16 | 16 | 5.26 | 36 | 76TN2820(1)H4(2) | R76TN2820(1)H4(2) |
| 1600 | 650 | 0.1000 | 11.0 | 20.0 | 26.5 | 22.5 | 3,000 | 9,600,000 | 300 | 16 | 13 | 5.96 | 34 | 76TN3100(1)H4(2) | R76TN3100(1)H4(2) |
| 1600 | 650 | 0.0820 | 11.0 | 20.0 | 32.0 | 27.5 | 2,000 | 6,400,000 | 164 | 18 | 29 | 4.10 | 31 | 76TR2820(1)H3(2) | R76TR2820(1)H3(2) |
| 1600 | 650 | 0.1000 | 11.0 | 20.0 | 32.0 | 27.5 | 2,000 | 6,400,000 | 200 | 18 | 24 | 4.53 | 31 | 76TR3100(1)H3(2) | R76TR3100(1)H3(2) |
| 1600 | 650 | 0.1200 | 13.0 | 22.0 | 32.0 | 27.5 | 2,000 | 6,400,000 | 240 | 18 | 27 | 4.47 | 29 | 76TR3120(1)H3(2) | R76TR3120(1)H3(2) |
| 1600 | 650 | 0.1500 | 13.0 | 25.0 | 32.0 | 27.5 | 2,000 | 6,400,000 | 300 | 18 | 21 | 5.11 | 28 | 76TR3150(1)H4(2) | R76TR3150(1)H4(2) |
| 1600 | 650 | 0.1800 | 14.0 | 28.0 | 32.0 | 27.5 | 2,000 | 6,400,000 | 360 | 18 | 18 | 5.77 | 26 | 76TR3180(1)H4(2) | R76TR3180(1)H4(2) |
| 1600 | 650 | 0.2200 | 18.0 | 33.0 | 32.0 | 27.5 | 2,000 | 6,400,000 | 440 | 18 | 14 | 6.81 | 23 | 76TR3220(1)H3(2) | R76TR3220(1)H3(2) |
| 1600 | 650 | 0.2700 | 18.0 | 33.0 | 32.0 | 27.5 | 2,000 | 6,400,000 | 540 | 18 | 15 | 6.74 | 23 | 76TR3270(1)H3(2) | R76TR3270(1)H3(2) |
| 1600 | 650 | 0.3300 | 18.0 | 33.0 | 32.0 | 27.5 | 2,000 | 6,400,000 | 660 | 18 | 12 | 7.46 | 23 | 76TR3330(1)H3(2) | R76TR3330(1)H3(2) |
| 1600 | 650 | 0.3900 | 22.0 | 37.0 | 32.0 | 27.5 | 2,000 | 6,400,000 | 780 | 18 | 16 | 6.74 | 21 | 76TR3390(1)H3(2) | R76TR3390(1)H3(2) |
| 1600 | 650 | 0.4700 | 22.0 | 37.0 | 32.0 | 27.5 | 2,000 | 6,400,000 | 940 | 18 | 14 | 7.40 | 21 | 76TR3470(1)H3(2) | R76TR3470(1)H3(2) |
| 1600 | 650 | 0.0820 | 11.0 | 22.0 | 41.5 | 37.5 | 1,200 | 3,840,000 | 98 | 20 | 29 | 4.41 | 27 | 76TW2820(1)H3(2) | R76TW2820(1)H3(2) |
| 1600 | 650 | 0.1000 | 11.0 | 22.0 | 41.5 | 37.5 | 1,200 | 3,840,000 | 120 | 20 | 24 | 4.88 | 27 | 76TW3100(1)H3(2) | R76TW3100(1)H3(2) |
| 1600 | 650 | 0.1200 | 11.0 | 22.0 | 41.5 | 37.5 | 1,200 | 3,840,000 | 144 | 20 | 27 | 4.63 | 27 | 76TW3120(1)H3(2) | R76TW3120(1)H3(2) |
| 1600 | 650 | 0.1500 | 11.0 | 22.0 | 41.5 | 37.5 | 1,200 | 3,840,000 | 180 | 20 | 21 | 5.17 | 27 | 76TW3150(1)H3(2) | R76TW3150(1)H3(2) |
| 1600 | 650 | 0.1800 | 13.0 | 24.0 | 41.5 | 37.5 | 1,200 | 3,840,000 | 216 | 20 | 18 | 5.87 | 25 | 76TW3180(1)H3(2) | R76TW3180(1)H3(2) |
| 1600 | 650 | 0.1800 | 24.0 | 15.0 | 41.5 | 37.5 | 1,200 | 3,840,000 | 216 | 20 | 18 | 5.97 | 24 | 76TW3180(1)HL(2) | R76TW3180(1)HL(2) |
| 1600 | 650 | 0.2200 | 13.0 | 24.0 | 41.5 | 37.5 | 1,200 | 3,840,000 | 264 | 20 | 14 | 6.49 | 25 | 76TW3220(1)H3(2) | R76TW3220(1)H3(2) |
| 1600 | 650 | 0.2200 | 24.0 | 15.0 | 41.5 | 37.5 | 1,200 | 3,840,000 | 264 | 20 | 14 | 6.60 | 24 | 76TW3220(1)HL(2) | R76TW3220(1)HL(2) |
| 1600 | 650 | 0.2700 | 13.0 | 24.0 | 41.5 | 37.5 | 1,200 | 3,840,000 | 324 | 20 | 15 | 6.43 | 25 | 76TW3270(1)H3(2) | R76TW3270(1)H3(2) |
| 1600 | 650 | 0.2700 | 24.0 | 15.0 | 41.5 | 37.5 | 1,200 | 3,840,000 | 324 | 20 | 15 | 6.54 | 24 | 76TW3270(1)HL(2) | R76TW3270(1)HL(2) |
| 1600 | 650 | 0.3300 | 16.0 | 28.5 | 41.5 | 37.5 | 1,200 | 3,840,000 | 396 | 20 | 12 | 7.52 | 23 | 76TW3330(1)H3(2) | R76TW3330(1)H3(2) |

(1) Insert lead and packaging code. See Ordering Options Table for available options.

(2) H = 2.5% (only for C ≥ 1,000 pF), J = 5%, K = 10%

(*) I_{rms} value that leads to a ΔT of ≈ 15°C in the hot spot > T_{HS} = T_{AMB} + ΔT = 100°C + 15°C = 115°C

Table 1 – Ratings & Part Number Reference cont.

| VDC | VAC | Cap Value (µF) | Dimensions in mm | | | Lead Spacing (p) | dV/dt (V/µs) | Max K ₀ (V ² /µs) | I _{pk} | ESL | ESR | I _{rms} max (*) | R _{th} | KEMET Internal Part Number | Customer Part Number |
|------|-----|----------------|------------------|--------------|---|------------------|---------------------|---|--------------------------|---------------------|----------------------------|--------------------------|-----------------|----------------------------|----------------------|
| | | | | | | | | | | Lead Length 2x 4 mm | at 100 kHz | at 100 kHz, 100°C | (°C/W) | | |
| | | | A _{pk} | nH | mΩ | | | | A _{rms} | (°C/W) | | | | | |
| W | H | L | Lead Spacing (p) | dV/dt (V/µs) | Max K ₀ (V ² /µs) | A _{pk} | Lead Length 2x 4 mm | at 100 kHz | I _{rms} max (*) | R _{th} | KEMET Internal Part Number | Customer Part Number | | | |
| 1600 | 650 | 0.3300 | 24.0 | 15.0 | 41.5 | 37.5 | 1,200 | 3,840,000 | 396 | 20 | 12 | 7.23 | 24 | 76TW3330(1)H(2) | R76TW3330(1)H(2) |
| 1600 | 650 | 0.3900 | 16.0 | 28.5 | 41.5 | 37.5 | 1,200 | 3,840,000 | 468 | 20 | 16 | 6.46 | 23 | 76TW3390(1)H3(2) | R76TW3390(1)H3(2) |
| 1600 | 650 | 0.4700 | 19.0 | 32.0 | 41.5 | 37.5 | 1,200 | 3,840,000 | 564 | 20 | 14 | 7.41 | 21 | 76TW3470(1)H3(2) | R76TW3470(1)H3(2) |
| 1600 | 650 | 0.5600 | 20.0 | 40.0 | 41.5 | 37.5 | 1,200 | 3,840,000 | 672 | 20 | 11 | 8.49 | 19 | 76TW3560(1)H3(2) | R76TW3560(1)H3(2) |
| 1600 | 650 | 0.6800 | 20.0 | 40.0 | 41.5 | 37.5 | 1,200 | 3,840,000 | 816 | 20 | 11 | 8.82 | 19 | 76TW3680(1)H3(2) | R76TW3680(1)H3(2) |
| 1600 | 650 | 0.8200 | 24.0 | 44.0 | 41.5 | 37.5 | 1,200 | 3,840,000 | 984 | 20 | 9 | 10.11 | 17 | 76TW3820(1)H3(2) | R76TW3820(1)H3(2) |
| 1600 | 650 | 1.0000 | 24.0 | 44.0 | 41.5 | 37.5 | 1,200 | 3,840,000 | 1,200 | 20 | 7 | 11.16 | 17 | 76TW4100(1)H3(2) | R76TW4100(1)H3(2) |
| 1600 | 650 | 1.2000 | 30.0 | 45.0 | 41.5 | 37.5 | 1,200 | 3,840,000 | 1,440 | 20 | 16 | 7.77 | 16 | 76TW4120(1)H3(2) | R76TW4120(1)H3(2) |
| 2000 | 700 | 0.00056 | 4.0 | 10.0 | 18.0 | 15.0 | 9,500 | 38,000,000 | 5 | 10 | 1,137 | 0.25 | 65 | 76UI0560(1)H4(2) | R76UI0560(1)H4(2) |
| 2000 | 700 | 0.00056 | 5.0 | 11.0 | 18.0 | 15.0 | 9,500 | 38,000,000 | 5 | 10 | 1,137 | 0.25 | 60 | 76UI0560(1)H3(2) | R76UI0560(1)H3(2) |
| 2000 | 700 | 0.00068 | 4.0 | 10.0 | 18.0 | 15.0 | 9,500 | 38,000,000 | 6 | 10 | 936 | 0.30 | 65 | 76UI0680(1)H4(2) | R76UI0680(1)H4(2) |
| 2000 | 700 | 0.00068 | 5.0 | 11.0 | 18.0 | 15.0 | 9,500 | 38,000,000 | 6 | 10 | 936 | 0.30 | 60 | 76UI0680(1)H3(2) | R76UI0680(1)H3(2) |
| 2000 | 700 | 0.00082 | 4.0 | 10.0 | 18.0 | 15.0 | 9,500 | 38,000,000 | 8 | 10 | 776 | 0.36 | 65 | 76UI0820(1)H4(2) | R76UI0820(1)H4(2) |
| 2000 | 700 | 0.00082 | 5.0 | 11.0 | 18.0 | 15.0 | 9,500 | 38,000,000 | 8 | 10 | 776 | 0.36 | 60 | 76UI0820(1)H3(2) | R76UI0820(1)H3(2) |
| 2000 | 700 | 0.0010 | 4.0 | 10.0 | 18.0 | 15.0 | 9,500 | 38,000,000 | 10 | 10 | 637 | 0.44 | 65 | 76UI1100(1)H4(2) | R76UI1100(1)H4(2) |
| 2000 | 700 | 0.0010 | 5.0 | 11.0 | 18.0 | 15.0 | 9,500 | 38,000,000 | 10 | 10 | 637 | 0.44 | 60 | 76UI1100(1)H3(2) | R76UI1100(1)H3(2) |
| 2000 | 700 | 0.0012 | 4.0 | 10.0 | 18.0 | 15.0 | 9,500 | 38,000,000 | 11 | 10 | 531 | 0.53 | 65 | 76UI1120(1)H4(2) | R76UI1120(1)H4(2) |
| 2000 | 700 | 0.0012 | 5.0 | 11.0 | 18.0 | 15.0 | 9,500 | 38,000,000 | 11 | 10 | 531 | 0.53 | 60 | 76UI1120(1)H3(2) | R76UI1120(1)H3(2) |
| 2000 | 700 | 0.0015 | 4.0 | 10.0 | 18.0 | 15.0 | 9,500 | 38,000,000 | 14 | 10 | 424 | 0.66 | 65 | 76UI1150(1)H4(2) | R76UI1150(1)H4(2) |
| 2000 | 700 | 0.0015 | 5.0 | 11.0 | 18.0 | 15.0 | 9,500 | 38,000,000 | 14 | 10 | 424 | 0.66 | 60 | 76UI1150(1)H3(2) | R76UI1150(1)H3(2) |
| 2000 | 700 | 0.0018 | 4.0 | 10.0 | 18.0 | 15.0 | 9,500 | 38,000,000 | 17 | 10 | 354 | 0.79 | 65 | 76UI1180(1)H4(2) | R76UI1180(1)H4(2) |
| 2000 | 700 | 0.0018 | 5.0 | 11.0 | 18.0 | 15.0 | 9,500 | 38,000,000 | 17 | 10 | 354 | 0.79 | 60 | 76UI1180(1)H3(2) | R76UI1180(1)H3(2) |
| 2000 | 700 | 0.0022 | 4.0 | 10.0 | 18.0 | 15.0 | 9,500 | 38,000,000 | 21 | 10 | 289 | 0.90 | 65 | 76UI1220(1)H4(2) | R76UI1220(1)H4(2) |
| 2000 | 700 | 0.0022 | 5.0 | 11.0 | 18.0 | 15.0 | 9,500 | 38,000,000 | 21 | 10 | 289 | 0.94 | 60 | 76UI1220(1)H3(2) | R76UI1220(1)H3(2) |
| 2000 | 700 | 0.0027 | 4.0 | 10.0 | 18.0 | 15.0 | 9,500 | 38,000,000 | 26 | 10 | 236 | 1.00 | 65 | 76UI1270(1)H4(2) | R76UI1270(1)H4(2) |
| 2000 | 700 | 0.0027 | 5.0 | 11.0 | 18.0 | 15.0 | 9,500 | 38,000,000 | 26 | 10 | 236 | 1.04 | 60 | 76UI1270(1)H3(2) | R76UI1270(1)H3(2) |
| 2000 | 700 | 0.0033 | 5.0 | 11.0 | 18.0 | 15.0 | 9,500 | 38,000,000 | 31 | 10 | 193 | 1.15 | 60 | 76UI1330(1)H4(2) | R76UI1330(1)H4(2) |
| 2000 | 700 | 0.0039 | 5.0 | 11.0 | 18.0 | 15.0 | 9,500 | 38,000,000 | 37 | 10 | 163 | 1.25 | 60 | 76UI1390(1)H4(2) | R76UI1390(1)H4(2) |
| 2000 | 700 | 0.0047 | 5.0 | 11.0 | 18.0 | 15.0 | 9,500 | 38,000,000 | 45 | 10 | 135 | 1.37 | 60 | 76UI1470(1)H4(2) | R76UI1470(1)H4(2) |
| 2000 | 700 | 0.0056 | 6.0 | 12.0 | 18.0 | 15.0 | 9,500 | 38,000,000 | 53 | 10 | 114 | 1.56 | 56 | 76UI1560(1)H4(2) | R76UI1560(1)H4(2) |
| 2000 | 700 | 0.0068 | 6.0 | 12.0 | 18.0 | 15.0 | 9,500 | 38,000,000 | 65 | 10 | 94 | 1.71 | 56 | 76UI1680(1)H4(2) | R76UI1680(1)H4(2) |
| 2000 | 700 | 0.0082 | 6.0 | 12.0 | 18.0 | 15.0 | 9,500 | 38,000,000 | 78 | 10 | 78 | 1.88 | 56 | 76UI1820(1)H4(2) | R76UI1820(1)H4(2) |
| 2000 | 700 | 0.0100 | 7.5 | 13.5 | 18.0 | 15.0 | 9,500 | 38,000,000 | 95 | 10 | 64 | 2.18 | 51 | 76UI2100(1)H4(2) | R76UI2100(1)H4(2) |
| 2000 | 700 | 0.0100 | 13.0 | 12.0 | 18.0 | 15.0 | 9,500 | 38,000,000 | 95 | 10 | 64 | 2.32 | 45 | 76UI2100(1)H7(2) | R76UI2100(1)H7(2) |
| 2000 | 700 | 0.0120 | 8.5 | 14.5 | 18.0 | 15.0 | 9,500 | 38,000,000 | 114 | 10 | 53 | 2.46 | 48 | 76UI2120(1)H4(2) | R76UI2120(1)H4(2) |
| 2000 | 700 | 0.0150 | 8.5 | 14.5 | 18.0 | 15.0 | 9,500 | 38,000,000 | 143 | 10 | 42 | 2.75 | 48 | 76UI2150(1)H4(2) | R76UI2150(1)H4(2) |
| 2000 | 700 | 0.0022 | 6.0 | 15.0 | 26.5 | 22.5 | 4,500 | 18,000,000 | 10 | 16 | 289 | 0.97 | 43 | 76UN1220(1)H0(2) | R76UN1220(1)H0(2) |
| 2000 | 700 | 0.0027 | 6.0 | 15.0 | 26.5 | 22.5 | 4,500 | 18,000,000 | 12 | 16 | 236 | 1.19 | 43 | 76UN1270(1)H0(2) | R76UN1270(1)H0(2) |
| 2000 | 700 | 0.0033 | 6.0 | 15.0 | 26.5 | 22.5 | 4,500 | 18,000,000 | 15 | 16 | 193 | 1.35 | 43 | 76UN1330(1)H0(2) | R76UN1330(1)H0(2) |
| 2000 | 700 | 0.0039 | 6.0 | 15.0 | 26.5 | 22.5 | 4,500 | 18,000,000 | 18 | 16 | 163 | 1.47 | 43 | 76UN1390(1)H0(2) | R76UN1390(1)H0(2) |
| 2000 | 700 | 0.0047 | 6.0 | 15.0 | 26.5 | 22.5 | 4,500 | 18,000,000 | 21 | 16 | 135 | 1.62 | 43 | 76UN1470(1)H0(2) | R76UN1470(1)H0(2) |
| 2000 | 700 | 0.0056 | 6.0 | 15.0 | 26.5 | 22.5 | 4,500 | 18,000,000 | 25 | 16 | 114 | 1.77 | 43 | 76UN1560(1)H0(2) | R76UN1560(1)H0(2) |
| 2000 | 700 | 0.0068 | 6.0 | 15.0 | 26.5 | 22.5 | 4,500 | 18,000,000 | 31 | 16 | 94 | 1.95 | 43 | 76UN1680(1)H0(2) | R76UN1680(1)H0(2) |
| 2000 | 700 | 0.0082 | 6.0 | 15.0 | 26.5 | 22.5 | 4,500 | 18,000,000 | 37 | 16 | 78 | 2.14 | 43 | 76UN1820(1)H3(2) | R76UN1820(1)H3(2) |
| 2000 | 700 | 0.0100 | 6.0 | 15.0 | 26.5 | 22.5 | 4,500 | 18,000,000 | 45 | 16 | 64 | 2.36 | 43 | 76UN2100(1)H3(2) | R76UN2100(1)H3(2) |
| 2000 | 700 | 0.0120 | 6.0 | 15.0 | 26.5 | 22.5 | 4,500 | 18,000,000 | 54 | 16 | 53 | 2.58 | 43 | 76UN2120(1)H3(2) | R76UN2120(1)H3(2) |
| 2000 | 700 | 0.0150 | 6.0 | 15.0 | 26.5 | 22.5 | 4,500 | 18,000,000 | 68 | 16 | 42 | 2.89 | 43 | 76UN2150(1)H4(2) | R76UN2150(1)H4(2) |
| 2000 | 700 | 0.0180 | 6.0 | 15.0 | 26.5 | 22.5 | 4,500 | 18,000,000 | 81 | 16 | 35 | 3.16 | 43 | 76UN2180(1)H4(2) | R76UN2180(1)H4(2) |
| 2000 | 700 | 0.0220 | 7.0 | 16.0 | 26.5 | 22.5 | 4,500 | 18,000,000 | 99 | 16 | 29 | 3.60 | 41 | 76UN2220(1)H4(2) | R76UN2220(1)H4(2) |
| 2000 | 700 | 0.0270 | 7.0 | 16.0 | 26.5 | 22.5 | 4,500 | 18,000,000 | 122 | 16 | 24 | 3.99 | 41 | 76UN2270(1)H4(2) | R76UN2270(1)H4(2) |
| 2000 | 700 | 0.0330 | 8.5 | 17.0 | 26.5 | 22.5 | 4,500 | 18,000,000 | 149 | 16 | 19 | 4.56 | 38 | 76UN2330(1)H4(2) | R76UN2330(1)H4(2) |

(1) Insert lead and packaging code. See Ordering Options Table for available options.

(2) H = 2.5% (only for C ≥ 1,000 pF), J = 5%, K = 10%

(*) I_{rms} value that leads to a ΔT of ≈ 15°C in the hot spot > T_{HS} = T_{AMB} + ΔT = 100°C + 15°C = 115°C

Table 1 – Ratings & Part Number Reference cont.

| VDC | VAC | Cap Value (µF) | Dimensions in mm | | | Lead Spacing (p) | dV/dt (V/µs) | Max K ₀ (V ² /µs) | I _{pk} | ESL | ESR | I _{rms} max (*) | R _{th} | KEMET Internal Part Number | Customer Part Number |
|------|-----|----------------|---------------------|------------|-------------------|------------------|--------------|---|-----------------|---------------------|-----------------|--------------------------|-----------------|----------------------------|----------------------|
| | | | Lead Length 2x 4 mm | at 100 kHz | at 100 kHz, 100°C | | | | | R _{th} | | | | | |
| | | | | | | | | | | | A _{pk} | nH | mΩ | | |
| W | H | L | | | | | | | | | | | | | |
| 2000 | 700 | 0.0390 | 10.0 | 18.5 | 26.5 | 22.5 | 4,500 | 18,000,000 | 176 | 16 | 16 | 5.13 | 36 | 76UN2390(1)H4(2) | R76UN2390(1)H4(2) |
| 2000 | 700 | 0.0470 | 10.0 | 18.5 | 26.5 | 22.5 | 4,500 | 18,000,000 | 212 | 16 | 14 | 5.63 | 36 | 76UN2470(1)H4(2) | R76UN2470(1)H4(2) |
| 2000 | 700 | 0.0560 | 11.0 | 20.0 | 26.5 | 22.5 | 4,500 | 18,000,000 | 252 | 16 | 23 | 4.46 | 34 | 76UN2560(1)H4(2) | R76UN2560(1)H4(2) |
| 2000 | 700 | 0.0390 | 11.0 | 20.0 | 32.0 | 27.5 | 2,500 | 10,000,000 | 98 | 18 | 41 | 3.46 | 31 | 76UR2390(1)H2(2) | R76UR2390(1)H2(2) |
| 2000 | 700 | 0.0470 | 11.0 | 20.0 | 32.0 | 27.5 | 2,500 | 10,000,000 | 118 | 18 | 34 | 3.80 | 31 | 76UR2470(1)H3(2) | R76UR2470(1)H3(2) |
| 2000 | 700 | 0.0560 | 13.0 | 22.0 | 32.0 | 27.5 | 2,500 | 10,000,000 | 140 | 18 | 43 | 3.52 | 29 | 76UR2560(1)H3(2) | R76UR2560(1)H3(2) |
| 2000 | 700 | 0.0680 | 13.0 | 22.0 | 32.0 | 27.5 | 2,500 | 10,000,000 | 170 | 18 | 35 | 3.88 | 29 | 76UR2680(1)H3(2) | R76UR2680(1)H3(2) |
| 2000 | 700 | 0.0820 | 13.0 | 25.0 | 32.0 | 27.5 | 2,500 | 10,000,000 | 205 | 18 | 29 | 4.36 | 28 | 76UR2820(1)H4(2) | R76UR2820(1)H4(2) |
| 2000 | 700 | 0.1000 | 14.0 | 28.0 | 32.0 | 27.5 | 2,500 | 10,000,000 | 250 | 18 | 24 | 4.97 | 26 | 76UR3100(1)H3(2) | R76UR3100(1)H3(2) |
| 2000 | 700 | 0.1200 | 18.0 | 33.0 | 32.0 | 27.5 | 2,500 | 10,000,000 | 300 | 18 | 27 | 5.03 | 23 | 76UR3120(1)H3(2) | R76UR3120(1)H3(2) |
| 2000 | 700 | 0.1500 | 18.0 | 33.0 | 32.0 | 27.5 | 2,500 | 10,000,000 | 375 | 18 | 21 | 5.62 | 23 | 76UR3150(1)H3(2) | R76UR3150(1)H3(2) |
| 2000 | 700 | 0.1800 | 22.0 | 37.0 | 32.0 | 27.5 | 2,500 | 10,000,000 | 450 | 18 | 18 | 6.47 | 21 | 76UR3180(1)H3(2) | R76UR3180(1)H3(2) |
| 2000 | 700 | 0.2200 | 22.0 | 37.0 | 32.0 | 27.5 | 2,500 | 10,000,000 | 550 | 18 | 14 | 7.16 | 21 | 76UR3220(1)H3(2) | R76UR3220(1)H3(2) |
| 2000 | 700 | 0.0330 | 11.0 | 22.0 | 41.5 | 37.5 | 1,500 | 6,000,000 | 50 | 20 | 48 | 3.43 | 27 | 76UW2330(1)H3(2) | R76UW2330(1)H3(2) |
| 2000 | 700 | 0.0390 | 11.0 | 22.0 | 41.5 | 37.5 | 1,500 | 6,000,000 | 59 | 20 | 41 | 3.73 | 27 | 76UW2390(1)H3(2) | R76UW2390(1)H3(2) |
| 2000 | 700 | 0.0470 | 11.0 | 22.0 | 41.5 | 37.5 | 1,500 | 6,000,000 | 71 | 20 | 34 | 4.09 | 27 | 76UW2470(1)H3(2) | R76UW2470(1)H3(2) |
| 2000 | 700 | 0.0560 | 11.0 | 22.0 | 41.5 | 37.5 | 1,500 | 6,000,000 | 84 | 20 | 43 | 3.65 | 27 | 76UW2560(1)H3(2) | R76UW2560(1)H3(2) |
| 2000 | 700 | 0.0680 | 11.0 | 22.0 | 41.5 | 37.5 | 1,500 | 6,000,000 | 102 | 20 | 35 | 4.02 | 27 | 76UW2680(1)H3(2) | R76UW2680(1)H3(2) |
| 2000 | 700 | 0.0820 | 11.0 | 22.0 | 41.5 | 37.5 | 1,500 | 6,000,000 | 123 | 20 | 29 | 4.41 | 27 | 76UW2820(1)H3(2) | R76UW2820(1)H3(2) |
| 2000 | 700 | 0.0820 | 24.0 | 15.0 | 41.5 | 37.5 | 1,500 | 6,000,000 | 123 | 20 | 29 | 4.65 | 24 | 76UW2820(1)HL(2) | R76UW2820(1)HL(2) |
| 2000 | 700 | 0.1000 | 13.0 | 24.0 | 41.5 | 37.5 | 1,500 | 6,000,000 | 150 | 20 | 24 | 5.05 | 25 | 76UW3100(1)H3(2) | R76UW3100(1)H3(2) |
| 2000 | 700 | 0.1000 | 24.0 | 15.0 | 41.5 | 37.5 | 1,500 | 6,000,000 | 150 | 20 | 24 | 5.14 | 24 | 76UW3100(1)HL(2) | R76UW3100(1)HL(2) |
| 2000 | 700 | 0.1200 | 13.0 | 24.0 | 41.5 | 37.5 | 1,500 | 6,000,000 | 180 | 20 | 27 | 4.79 | 25 | 76UW3120(1)H3(2) | R76UW3120(1)H3(2) |
| 2000 | 700 | 0.1200 | 24.0 | 15.0 | 41.5 | 37.5 | 1,500 | 6,000,000 | 180 | 20 | 27 | 4.88 | 24 | 76UW3120(1)HL(2) | R76UW3120(1)HL(2) |
| 2000 | 700 | 0.1500 | 16.0 | 28.5 | 41.5 | 37.5 | 1,500 | 6,000,000 | 225 | 20 | 21 | 5.67 | 23 | 76UW3150(1)H3(2) | R76UW3150(1)H3(2) |
| 2000 | 700 | 0.1500 | 24.0 | 19.0 | 41.5 | 37.5 | 1,500 | 6,000,000 | 225 | 20 | 21 | 5.63 | 23 | 76UW3150(1)HL(2) | R76UW3150(1)HL(2) |
| 2000 | 700 | 0.1800 | 16.0 | 28.5 | 41.5 | 37.5 | 1,500 | 6,000,000 | 270 | 20 | 18 | 6.21 | 23 | 76UW3180(1)H3(2) | R76UW3180(1)H3(2) |
| 2000 | 700 | 0.1800 | 24.0 | 19.0 | 41.5 | 37.5 | 1,500 | 6,000,000 | 270 | 20 | 18 | 6.17 | 23 | 76UW3180(1)HL(2) | R76UW3180(1)HL(2) |
| 2000 | 700 | 0.2200 | 19.0 | 32.0 | 41.5 | 37.5 | 1,500 | 6,000,000 | 330 | 20 | 14 | 7.17 | 21 | 76UW3220(1)H3(2) | R76UW3220(1)H3(2) |
| 2000 | 700 | 0.2700 | 20.0 | 40.0 | 41.5 | 37.5 | 1,500 | 6,000,000 | 405 | 20 | 15 | 7.46 | 19 | 76UW3270(1)H3(2) | R76UW3270(1)H3(2) |
| 2000 | 700 | 0.3300 | 20.0 | 40.0 | 41.5 | 37.5 | 1,500 | 6,000,000 | 495 | 20 | 12 | 8.25 | 19 | 76UW3330(1)H3(2) | R76UW3330(1)H3(2) |
| 2000 | 700 | 0.3900 | 24.0 | 44.0 | 41.5 | 37.5 | 1,500 | 6,000,000 | 585 | 20 | 16 | 7.39 | 17 | 76UW3390(1)H3(2) | R76UW3390(1)H3(2) |
| 2000 | 700 | 0.4700 | 24.0 | 44.0 | 41.5 | 37.5 | 1,500 | 6,000,000 | 705 | 20 | 14 | 8.12 | 17 | 76UW3470(1)H3(2) | R76UW3470(1)H3(2) |
| 2000 | 700 | 0.5600 | 30.0 | 45.0 | 41.5 | 37.5 | 1,500 | 6,000,000 | 840 | 20 | 11 | 9.19 | 16 | 76UW3560(1)H3(2) | R76UW3560(1)H3(2) |
| VDC | VAC | Cap Value | W | H | L | Lead Spacing (p) | dV/dt (V/µs) | Max K ₀ (V ² /µs) | A _{pk} | Lead Length 2x 4 mm | at 100 kHz | at 100 kHz, 100°C | (°C/W) | KEMET Internal Part Number | Customer Part Number |
| | | | | | | | | | I _{pk} | ESL | ESR | I _{rms} max (*) | R _{th} | | |

(1) Insert lead and packaging code. See Ordering Options Table for available options.

(2) H = 2.5% (only for C ≥ 1,000 pF), J = 5%, K = 10%

(*) I_{rms} value that leads to a ΔT of ≈ 15°C in the hot spot > T_{HS} = T_{AMB} + ΔT = 100°C + 15°C = 115°C

Soldering Process

The implementation of the RoHS directive has resulted in the selection of SnAgCu (SAC) alloys or SnCu alloys as primary solder. This has increased the liquidus temperature from that of 183°C for SnPb eutectic alloy to 217 – 221°C for the new alloys. As a result, the heat stress to the components, even in wave soldering, has increased considerably due to higher pre-heat and wave temperatures. Polypropylene capacitors are especially sensitive to heat (the melting point of polypropylene is 160 – 170°C). Wave soldering can be destructive, especially for mechanically small polypropylene capacitors (with lead spacing of 5 mm to 15 mm), and great care has to be taken during soldering. The recommended solder profiles from KEMET should be used. Please consult KEMET with any questions. In general, the wave soldering curve from IEC Publication 61760–1 Edition 2 serves as a solid guideline for successful soldering. Please see Figure 1.

Reflow soldering is not recommended for through-hole film capacitors. Exposing capacitors to a soldering profile in excess of the above recommended limits may result in degradation or permanent damage to the capacitors.

Do not place the polypropylene capacitor through an adhesive curing oven to cure resin for surface mount components. Insert through-hole parts after the curing of surface mount parts. Consult KEMET to discuss the actual temperature profile in the oven, if through-hole components must pass through the adhesive curing process. A maximum two soldering cycles is recommended. Please allow time for the capacitor surface temperature to return to a normal temperature before the second soldering cycle.

Manual Soldering Recommendations

Following is the recommendation for manual soldering with a soldering iron.

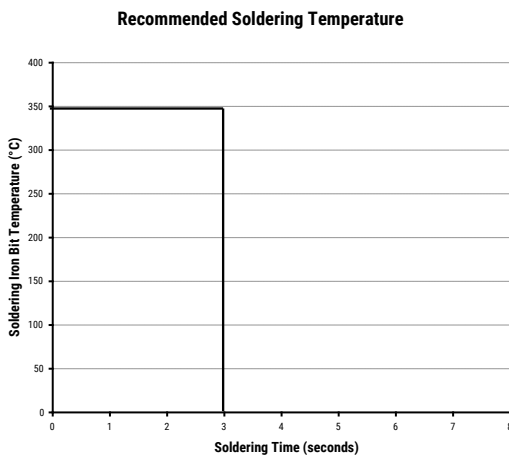

The soldering iron tip temperature should be set at 350°C (+10°C maximum) with the soldering duration not to exceed more than 3 seconds.

Wave Soldering Recommendations

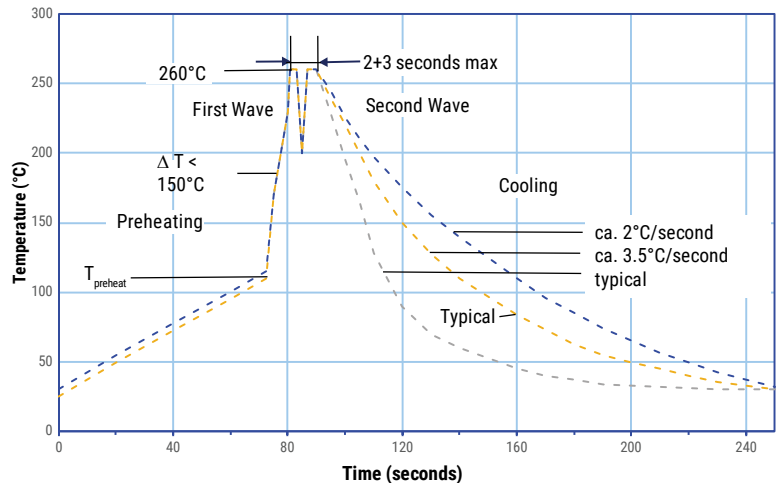

Soldering Process cont.

Wave Soldering Recommendations cont.

1. The table indicates the maximum set-up temperature of the soldering process

Figure 1

| Film Material | Maximum Preheat Temperature | | | Maximum Peak Soldering Temperature | |
|---|-----------------------------|-------------------------|-------------------------|------------------------------------|-------------------------|
| | Capacitor Pitch ≤ 10 mm | Capacitor Pitch = 15 mm | Capacitor Pitch > 15 mm | Capacitor Pitch ≤ 15 mm | Capacitor Pitch > 15 mm |
| Double Metallized Polystyrene and Single Metallized Polypropylene | 110°C | 110°C | 130°C | 260°C | 270°C |

2. The maximum temperature measured on the capacitor body:

Set the temperature so that the maximum temperature is below the limit:

| Film Material | Maximum Temperature Measured on the Capacitor Body |
|---|---|
| Double Metallized Polystyrene and Single Metallized Polypropylene | 120°C (for series R76) 125°C (for series R76 125°) |

Duration: < 60 seconds

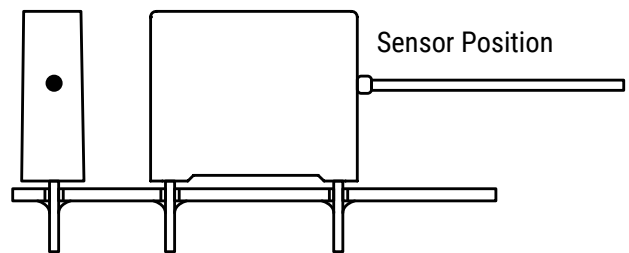

Selective Soldering Recommendations

Selective dip soldering is a variation of reflow soldering. In this method, the printed circuit board with through-hole components to be soldered is preheated and transported over the solder bath as in normal flow soldering without touching the solder. When the board is over the bath, it is stopped and pre-designed solder pots are lifted from the bath with molten solder only at the places of the selected components, and pressed against the lower surface of the board to solder the components.

The temperature profile for selective soldering is similar to the double wave flow soldering outlined in this document, **however, instead of two baths, there is only one bath with a time from 3 to 10 seconds.** In selective soldering, the risk of overheating is greater than in double wave flow soldering, and great care must be taken so that the parts are not overheated.

Mounting

Resistance to Vibration and Mechanical Shock

AEC-Q200 Mechanical Stress Tests:

| | | |
|-------------------------|-------------------------------|---|
| Mechanical Shock | MIL-STD-202 Method 213 | Test condition C Peak value 100 g, duration 6 ms, half-sine-wave (see MIL-HDBK for details) |
| Vibration | MIL-STD-202 Method 204 | 5 g for 20 minutes, 12 cycles each of 3 orientations Use 8"X5" PCB, 0.031" thick. 7 secure points on one 8" side and 2 secure points at corners of opposite sides. Parts mounted within 2" from any secure point. Test from 10 – 2,000 Hz. |

The capacitors are designed for PCB mounting. The stand-off pipes must be in good contact with the printed circuit board. The capacitors with pitch ≤ 22.5 mm can be mechanically fixed by the leads, for pitch > 22.5 mm, the capacitor body has to be properly fixed (e.g. clamped or glued).

Construction

1 Section

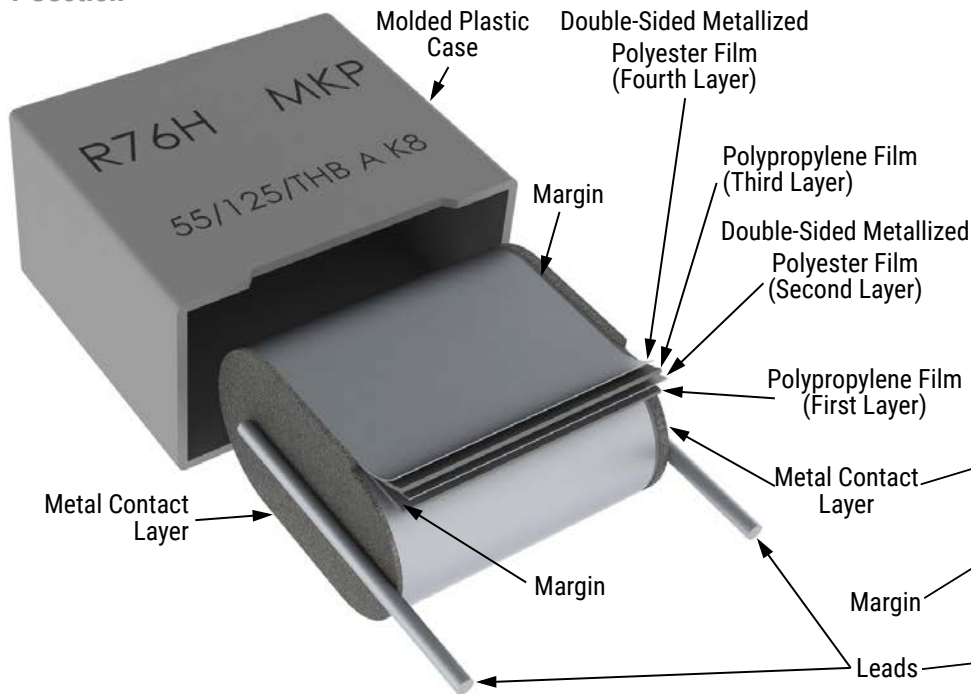

Detailed Cross Section

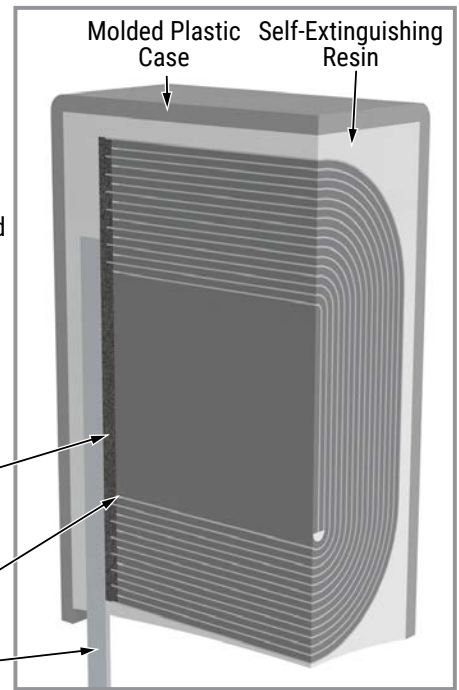

Construction cont.

Winding Schemes

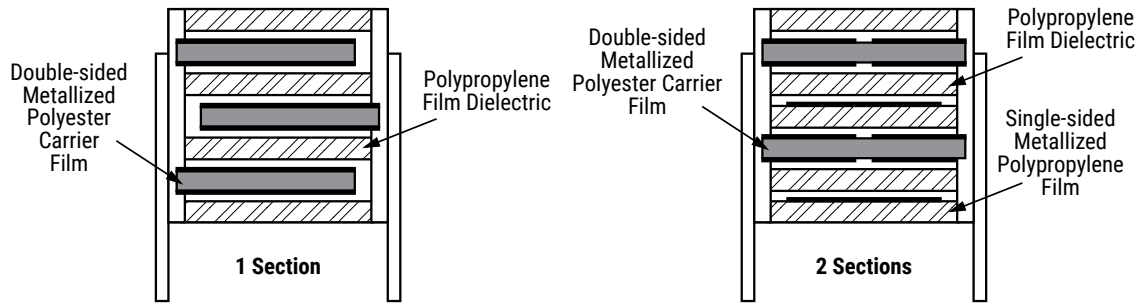

Low Profile Version

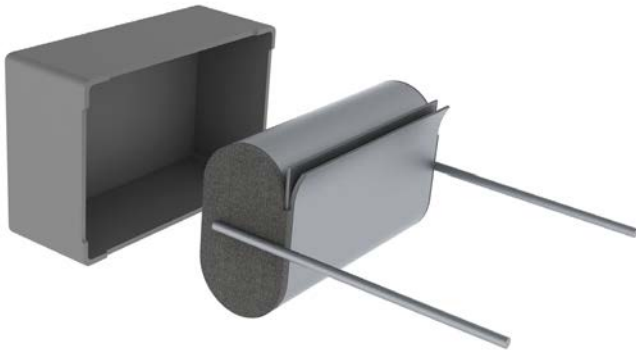

Marking

Pitch – 10, 15, & 22.5

Marking Variants*

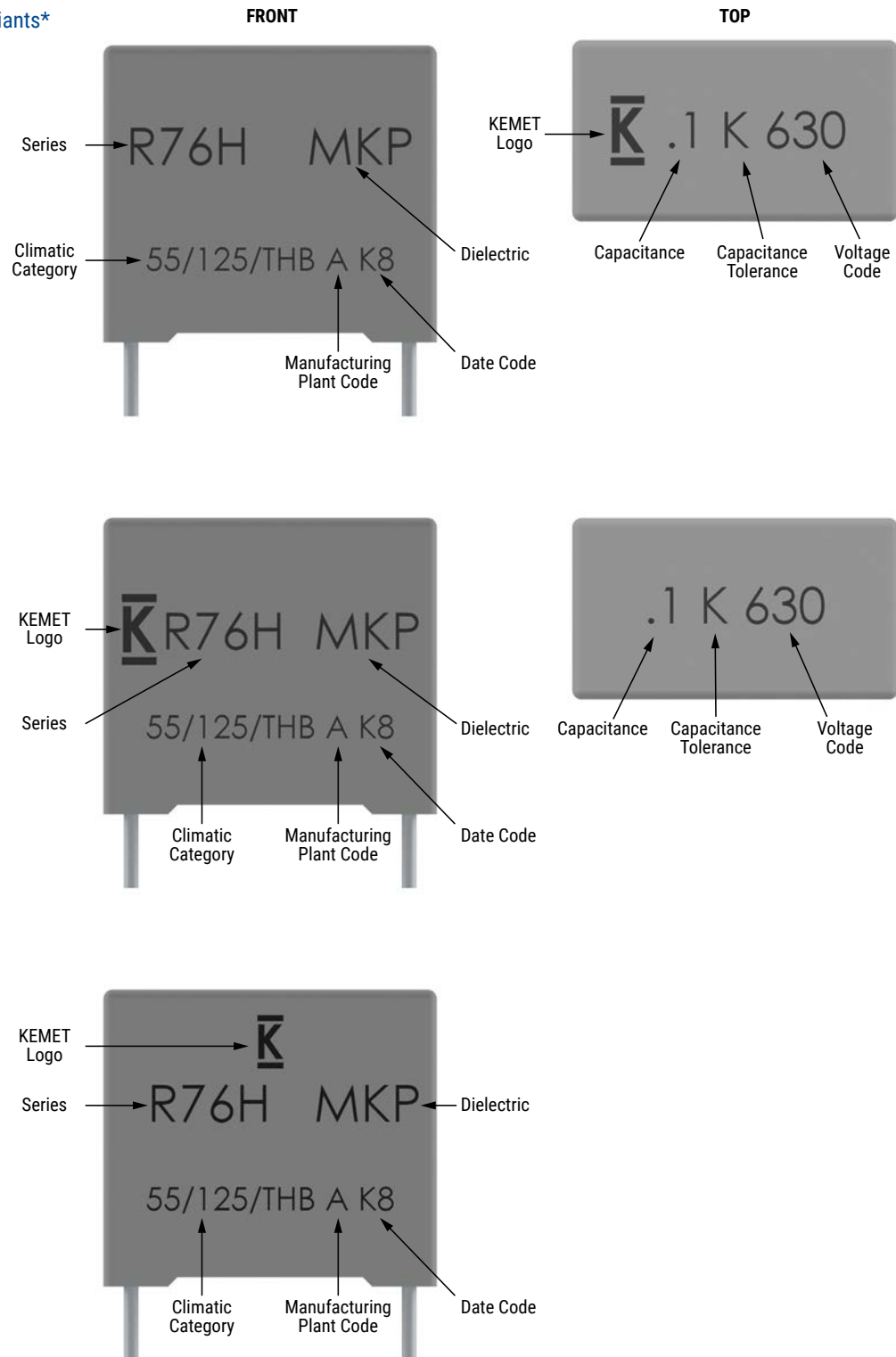

* Differences are caused by technology (clichee, laser, or ink) and technic (production line)

Marking cont.

Pitch – 10, 15, 22.5, 27.5, & 37.5

Marking Variants*

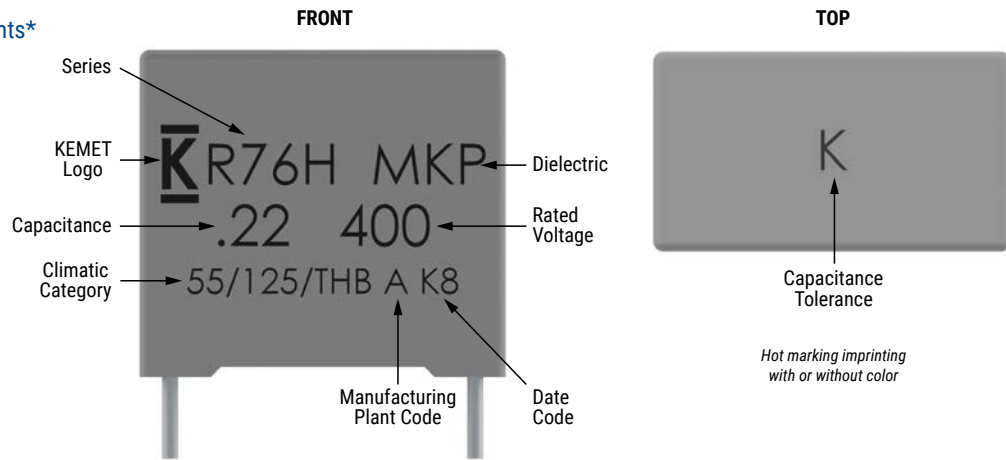

Pitch – 22.5, 27.5, & 37.5

Marking Variants*

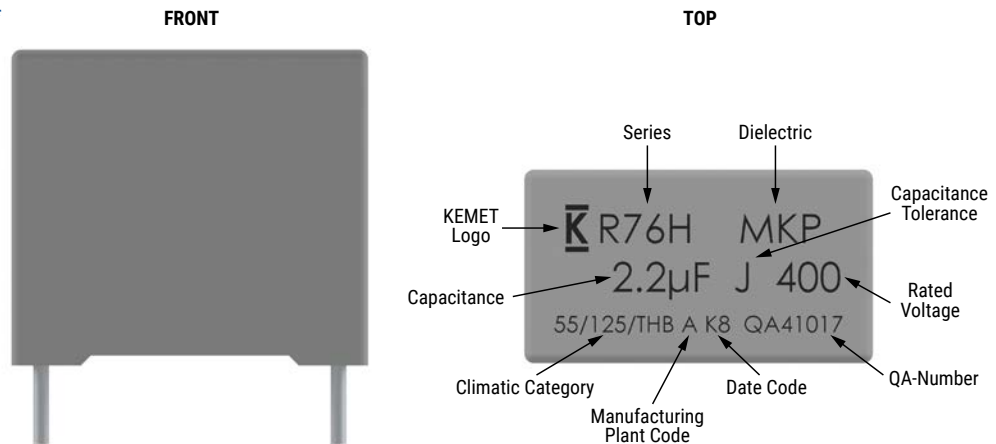

* Differences are caused by technology (clichee, laser, or ink) and technic (production line)

Packaging Quantities

| Lead Spacing | Thickness (mm) | Height (mm) | Length (mm) | Bulk Short Leads | Bulk Long Leads | | Standard Reel ø 355 mm | Large Reel ø 500 mm | Ammo Taped |
|--------------|-------------------------|-------------|-------------|-------------------------|----------------------|---------|---------------------------|------------------------|------------|
| | Lead and Packaging Code | | | JA - JB JE - JH - SE | Z3 - JM ¹ | 40 - 50 | GY - CK | CK | DQ |
| 10 | 4.0 | 9.0 | 13.0 | 2,000 | 2,200 | 1,800 | 750 | 1,500 | 1,000 |
| | 5.0 | 11.0 | 13.0 | 1,300 | 2,000 | 1,500 | 600 | 1,250 | 800 |
| | 6.0 | 12.0 | 13.0 | 1,000 | 1,800 | 1,200 | 500 | 1,000 | 680 |
| 15 | 4.0 | 10.0 | 18.0 | 2,500 | 1,500 | 1,500 | 750 | 1,500 | 1,000 |
| | 5.0 | 11.0 | 18.0 | 2,000 | 1,250 | 1,000 | 600 | 1,250 | 800 |
| | 6.0 | 12.0 | 18.0 | 1,750 | 1,000 | 900 | 500 | 1,000 | 680 |
| | 7.5 | 13.5 | 18.0 | 1,000 | 800 | 700 | 350 | 800 | 500 |
| | 8.5 | 14.5 | 18.0 | 1,000 | 650 | 500 | 300 | 700 | 440 |
| | 9.0 | 12.5 | 18.0 | 1,000 | 700 | 520 | 270 | 650 | 410 |
| | 10.0 | 16.0 | 18.0 | 750 | 550 | 500 | 270 | 600 | 380 |
| | 11.0 | 19.0 | 18.0 | 450 | 400 | 350 | 270 | 500 | 340 |
| | 13.0 | 12.0 | 18.0 | 750 | 520 | 490 | 200 | 480 | 280 |
| 22.5 | 6.0 | 15.0 | 26.5 | 805 | 450 | 500 | 300 | 700 | 464 |
| | 7.0 | 16.0 | 26.5 | 700 | 450 | 500 | 250 | 550 | 380 |
| | 8.5 | 17.0 | 26.5 | 468 | 350 | 300 | 250 | 450 | 280 |
| | 10.0 | 18.5 | 26.5 | 396 | 350 | 300 | 160 | 350 | 235 |
| | 11.0 | 20.0 | 26.5 | 360 | 200 | 250 | 190 | 350 | 217 |
| | 13.0 | 22.0 | 26.5 | 300 | 150 | 200 | 130 | 300 | - |
| 27.5 | 9.0 | 17.0 | 32.0 | 816 | - | 408 | 230 | 450 | - |
| | 11.0 | 20.0 | 32.0 | 560 | - | 336 | 190 | 350 | - |
| | 13.0 | 12.0 | 32.0 | 672 | - | 288 | - | - | - |
| | 13.0 | 22.0 | 32.0 | 480 | - | 288 | 150 | 300 | - |
| | 13.0 | 25.0 | 32.0 | 480 | - | 288 | - | 300 | - |
| | 14.0 | 28.0 | 32.0 | 352 | - | 176 | - | - | - |
| | 18.0 | 33.0 | 32.0 | 256 | - | 128 | - | - | - |
| | 22.0 | 37.0 | 32.0 | 168 | - | 112 | - | - | - |
| 37.5 | 11.0 | 22.0 | 41.5 | 420 | - | 252 | - | - | - |
| | 13.0 | 24.0 | 41.5 | 360 | - | 216 | - | - | - |
| | 16.0 | 28.5 | 41.5 | 216 | - | 108 | - | - | - |
| | 19.0 | 32.0 | 41.5 | 192 | - | 96 | - | - | - |
| | 20.0 | 40.0 | 41.5 | 126 | - | 84 | - | - | - |
| | 24.0 | 15.0 | 41.5 | 252 | - | 108 | - | - | - |
| | 24.0 | 19.0 | 41.5 | 216 | - | 108 | - | - | - |
| | 24.0 | 44.0 | 41.5 | 108 | - | 72 | - | - | - |
| | 30.0 | 45.0 | 41.5 | 90 | - | 60 | - | - | - |

¹ Only for > 7.5 mm lead spacing.

Lead Taping & Packaging (IEC 60286-2)

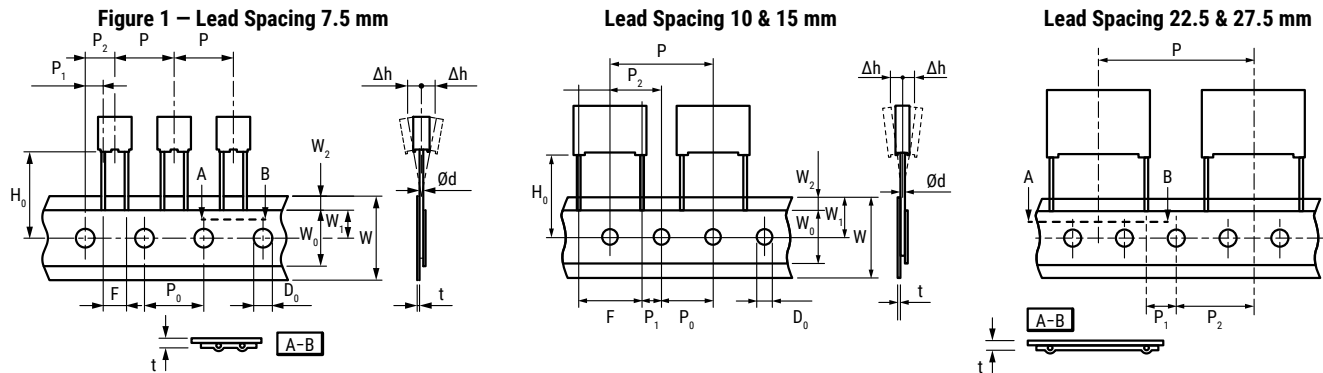

Taping Specification

| Description | Symbol | Dimensions (mm) | | | | | Tolerance |
|--------------------------------------|---------------------|-----------------|------|-----------|-------|-------|-----------|
| | | Lead Spacing | | | | | |
| | | 7.5 | 10.0 | 15.0 | 22.5 | 27.5 | |
| Lead wire diameter | d | 0.5 – 0.6 | 0.6 | 0.6 – 0.8 | 0.8 | 0.8 | ±0.05 |
| Taping lead space | P | 12.7 | 25.4 | 25.4 | 38.1 | 38.1 | ±1 |
| Feed hole lead space * | P ₀ | 12.7 | 12.7 | 12.7 | 12.7 | 12.7 | ±0.2 ** |
| Centering of the lead wire | P ₁ | 2.6 | 7.7 | 5.2 | 7.8 | 5.3 | ±0.7 |
| Centering of the body | P ₂ | 6.35 | 12.7 | 12.7 | 19.05 | 19.05 | ±1.3 |
| Lead spacing *** | F | 7.5 | 10.0 | 15.0 | 22.5 | 27.5 | +0.6/-0.1 |
| Component alignment | Δh | 0 | 0 | 0 | 0 | 0 | ±2 |
| Component deviation | Δp | 0 | 0 | 0 | 0 | 0 | ±1 |
| Height of component from tape center | H ₀ **** | 18.5 | 18.5 | 18.5 | 18.5 | 18.5 | ±0.5 |
| Carrier tape width | W | 18 | 18 | 18 | 18 | 18 | +1/-0.5 |
| Hold down tape width | W ₀ | 6 | 9 | 10 | 10 | 10 | Minimum |
| Hole position | W ₁ | 9 | 9 | 9 | 9 | 9 | ±0.5 |
| Hold down tape position | W ₂ | 3 | 3 | 3 | 3 | 3 | Maximum |
| Feed hole diameter | D ₀ | 4 | 4 | 4 | 4 | 4 | ±0.2 |
| Total Tape thickness | t | 0.7 | 0.7 | 0.7 | 0.7 | 0.7 | ±0.2 |

* Available also 15 mm.

** Maximum 1 mm on 20 lead spacing.

*** 15 mm and 10 mm taped to 7.5 mm (crimped leads) available upon request.

**** H₀ = 16.5 mm is available upon request.

Lead Taping & Packaging (IEC 60286-2) cont.

Ammo Specifications

| Dimensions (mm) | | |
|-----------------|-----|----|
| H | W | T |
| 360 | 340 | 59 |

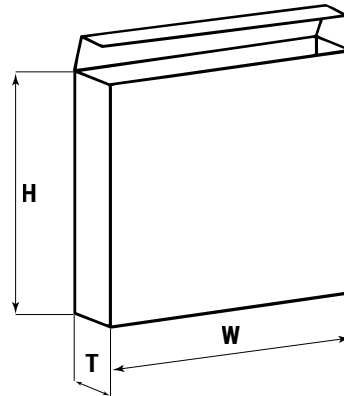

Reel Specifications

| Dimensions (mm) | | |
|-----------------|----|------------|
| D | H | W |
| 355 | 30 | 55 Maximum |
| 500 | 25 | |

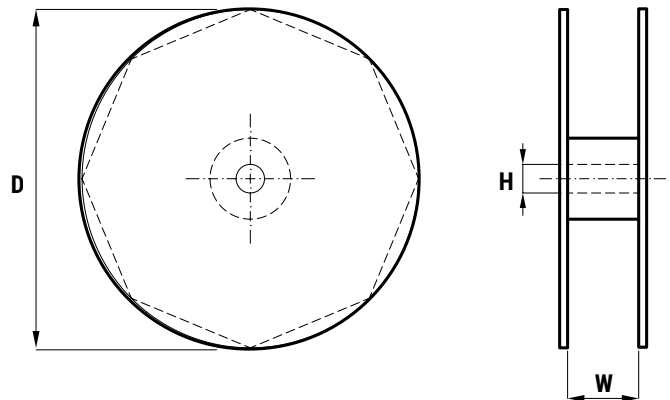

Manufacturing Date Code (IEC-60062)

| Y = Year, Z = Month | | | |
|---------------------|------|-----------|------|
| Year | Code | Month | Code |
| 2010 | A | January | 1 |
| 2011 | B | February | 2 |
| 2012 | C | March | 3 |
| 2013 | D | April | 4 |
| 2014 | E | May | 5 |
| 2015 | F | June | 6 |
| 2016 | H | July | 7 |
| 2017 | J | August | 8 |
| 2018 | K | September | 9 |
| 2019 | L | October | 0 |
| 2020 | M | November | N |
| 2021 | N | December | D |
| 2022 | P | | |
| 2023 | R | | |
| 2024 | S | | |
| 2025 | T | | |
| 2026 | U | | |
| 2027 | V | | |
| 2028 | W | | |
| 2029 | X | | |
| 2030 | A | | |

KEMET Electronics Corporation Sales Offices

For a complete list of our global sales offices, please visit www.kemet.com/sales.

Disclaimer

All product specifications, statements, information and data (collectively, the "Information") in this datasheet are subject to change. The customer is responsible for checking and verifying the extent to which the Information contained in this publication is applicable to an order at the time the order is placed. All Information given herein is believed to be accurate and reliable, but it is presented without guarantee, warranty, or responsibility of any kind, expressed or implied.

Statements of suitability for certain applications are based on KEMET Electronics Corporation's ("KEMET") knowledge of typical operating conditions for such applications, but are not intended to constitute – and KEMET specifically disclaims – any warranty concerning suitability for a specific customer application or use. The Information is intended for use only by customers who have the requisite experience and capability to determine the correct products for their application. Any technical advice inferred from this Information or otherwise provided by KEMET with reference to the use of KEMET's products is given gratis, and KEMET assumes no obligation or liability for the advice given or results obtained.

Although KEMET designs and manufactures its products to the most stringent quality and safety standards, given the current state of the art, isolated component failures may still occur. Accordingly, customer applications which require a high degree of reliability or safety should employ suitable designs or other safeguards (such as installation of protective circuitry or redundancies) in order to ensure that the failure of an electrical component does not result in a risk of personal injury or property damage.

Although all product-related warnings, cautions and notes must be observed, the customer should not assume that all safety measures are indicated or that other measures may not be required.

KEMET is a registered trademark of KEMET Electronics Corporation.

Mouser Electronics

Authorized Distributor

Click to View Pricing, Inventory, Delivery & Lifecycle Information:

KEMET:

[R76IN3560SEH3K](#) [R76IF233050H3J](#) [R76IF268050H3J](#) [R76II315050H3J](#) [R76II333050H7J](#) [R76IN368050H3J](#)
[R76IR415050H3J](#) [R76UN256050H4J](#) [R76UR282050H4J](#) [R76UI156050H4J](#) [R76UI182050H4J](#) [R76UI212050H4J](#)
[R76UN218050H4J](#) [R76UN227050H4J](#) [R76UN239050H4J](#) [R76UI056050H4J](#) [R76UI082050H4J](#) [R76UI112050H3J](#)
[R76UI118050H4J](#) [R76UI127050H4J](#) [R76UI139050H4J](#) [R76TR318050H4J](#) [R76TR327050H3J](#) [R76TR339050H3J](#)
[R76TW356050H3J](#) [R76TW382050H3J](#) [R76TW412050H3J](#) [R76TI227050H4J](#) [R76TN239050H4J](#) [R76TN247050H4J](#)
[R76TN256050H4J](#) [R76TN282050H4J](#) [R76TR312050H3J](#) [R76QW412050H3J](#) [R76TI139050H4J](#) [R76TI156050H4J](#)
[R76TI182050H4J](#) [R76TI212050H4J](#) [R76TI218050H4J](#) [R76QN312050H3J](#) [R76QR318050H3J](#) [R76QR327050H4J](#)
[R76QR339050H3J](#) [R76QR356050H3J](#) [R76QW382050H3J](#) [R76QI227050H4J](#) [R76QI233050H4J](#) [R76QI239050H4J](#)
[R76QI247050H4J](#) [R76QN256050H3J](#) [R76QN282050H3J](#) [R76QI210050H3J](#) [R76QI210050H4J](#) [R76QI212050H3J](#)
[R76QI215050H4J](#) [R76QI218050H4J](#) [R76QI222050H4J](#) [R76QF118050H0J](#) [R76QF127050H0J](#) [R76QF139050H3J](#)
[R76QF156050H3J](#) [R76QF168050H3J](#) [R76QI182050H4J](#) [R76PW410050HLJ](#) [R76PW433050H3J](#) [R76QF056050H0J](#)
[R76QF082050H0J](#) [R76QF110050H0J](#) [R76QF112050H0J](#) [R76PN315050H3J](#) [R76PN333050H3J](#)
[R76PR368050H4J](#) [R76PR412050H3J](#) [R76PR415050H3J](#) [R76PW410050H3J](#) [R76PF168050H0J](#) [R76PF215050H3J](#)
[R76PI227050H3J](#) [R76PI233050H3J](#) [R76PI239050H3J](#) [R76PI268050H7J](#) [R76MN333050H3J](#) [R76MN368050H3J](#)
[R76MR382050H3J](#) [R76MR415050H3J](#) [R76MW433050H3J](#) [R76MW468050H3J](#) [R76IR433050H3J](#) [R76IW468050H3J](#)
[R76MF215050H3J](#) [R76MF233050H3J](#) [R76MI268050H3J](#) [R76MI315050H7J](#) [R76TR322050H3J](#) [R76UI122050H4J](#)
[R76UI147050H4J](#) [R76UI210050H7J](#) [R76UN222050H4J](#) [R76TN222050H3J](#) [R76TN310050H4J](#)