

Features

- Formerly a **KOMATSULITE™** product
- Miniature Thermal Cutoff (TCO) device
- High current type
- Overtemperature and overcurrent protection for lithium polymer and prismatic cells
- Controls abnormal, excessive current virtually instantaneously
- Wide range of temperature options

Applications

Battery cell protection for:

- Notebook PCs
- Tablet PCs
- Smart phones
- Mobile phones

HC Series Breaker (Thermal Cutoff Device)

Ratings

Specification	Model				
	HC72AY-1	HC77AY-1	HC82AY-1	HC85AY-1	HC90AY-1
Trip Temperature	72 °C ± 5 °C	77 °C ± 5 °C	82 °C ± 5 °C	85 °C ± 5 °C	90 °C ± 5 °C
Reset Temperature	40 °C min.				
Contact Rating	DC9V / 25 A, 6000 cycles				
Maximum Breaking Current	DC5V / 80 A, 100 cycles				
Maximum Voltage	DC28V / 25 A, 100 cycles				
Minimum Holding Voltage	3 V @ 25 °C for 1 minute				
Maximum Leakage Current	200 mA max. @ 25 °C				
Resistance	5 milliohms max.				

Product Dimensions

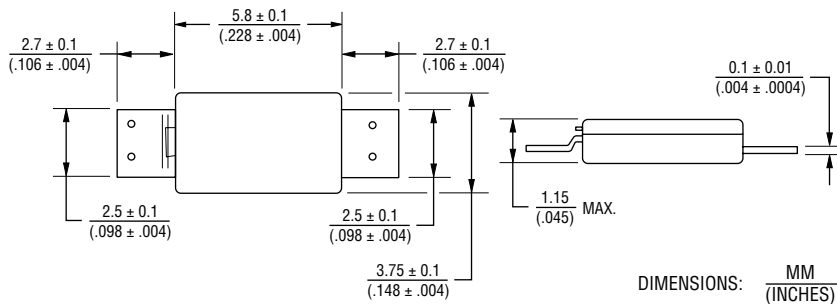

Product Structure

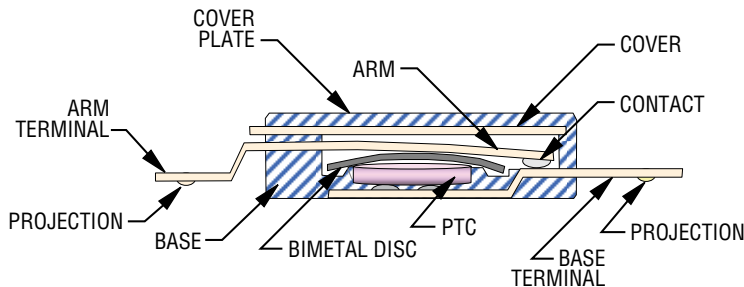

AVAILABLE WITH AND WITHOUT PROJECTIONS.

Agency Recognition

Description	
UL, cUL	File Number: E215638
TUV	File Number: R50203147

How to Order

Series Designator	HC 72 A Y - 1
Trip Temperature (±5 °C)	<ul style="list-style-type: none"> • 72 • 77 • 82 • 85 • 90
Arm Material	A = Cu Alloy
Manufacturer's Internal Code	
Terminal Type	(with/without Projection & Terminal Length)

* RoHS Directive 2002/95/EC Jan. 27, 2003 including annex and RoHS Recast 2011/65/EU June 8, 2011.

** Bourns considers a product to be "halogen free" if (a) the Bromine (Br) content is 900 ppm or less; (b) the Chlorine (Cl) content is 900 ppm or less; and (c) the total Bromine (Br) and Chlorine (Cl) content is 1500 ppm or less.

Specifications are subject to change without notice.

The device characteristics and parameters in this data sheet can and do vary in different applications and actual device performance may vary over time.

Users should verify actual device performance in their specific applications.

HC Series Breaker (Thermal Cutoff Device)

BOURNS®

Typical Performance

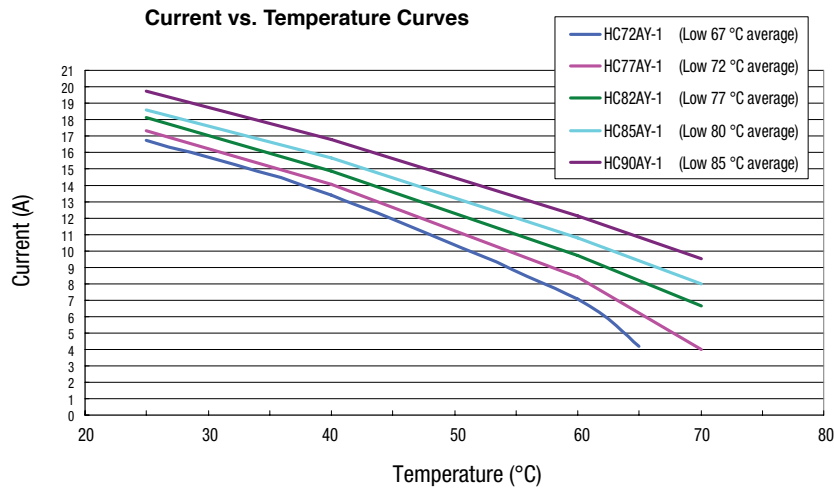

The above curves were derived from placing test samples in an oven at 25 °C, 40 °C, 60 °C and 70°C, increasing current flow through the sample at a rate of 0.1 A/minute and recording the current value when the sample trips.

Operation

NORMAL CIRCUIT

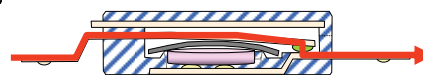

CURRENT

EXCESSIVE
CURRENT
AND/OR
HEAT

CIRCUIT
AFTER OPENING

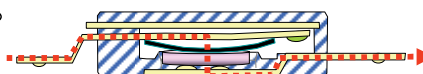
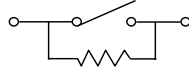

VERY LOW CURRENT

Specifications are subject to change without notice.

The device characteristics and parameters in this data sheet can and do vary in different applications and actual device performance may vary over time. Users should verify actual device performance in their specific applications.

HC Series Breaker (Thermal Cutoff Device)

BOURNS®

Wiring Recommendations

This is not a surface mount device for reflow soldering. Therefore, Ni tab wiring should be accomplished by either resistance or laser welding. Solder connections should be avoided.

Typical Part Marking

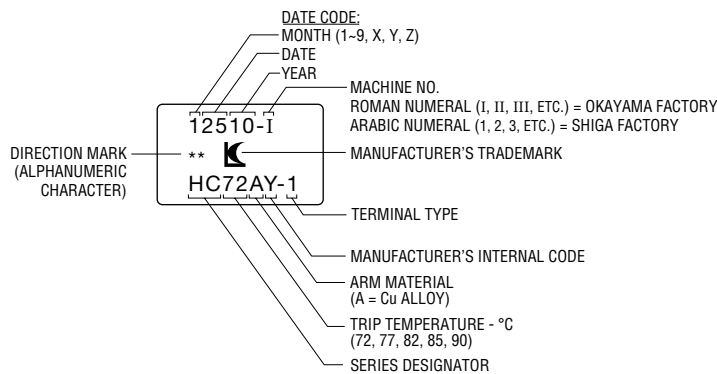

Standard Packaging Specifications

Plastic Bag.....	5,000 pcs. (fixed)
Inner Box.....	5,000 pcs. (fixed)
Outer Box.....	50,000 pcs. max. (up to 10 inner boxes)

BOURNS®

Asia-Pacific: Tel: +886-2 2562-4117 • Email: asiacus@bourns.com

EMEA: Tel: +36 88 520 390 • Email: eurocus@bourns.com

The Americas: Tel: +1-951 781-5500 • Email: americus@bourns.com

www.bourns.com

Specifications are subject to change without notice.

The device characteristics and parameters in this data sheet can and do vary in different applications and actual device performance may vary over time. Users should verify actual device performance in their specific applications.

HC Series Breaker (Thermal Cutoff Device)

BOURNS®

Caution when using Breaker

Before using the breaker, please fully read the *DESIGN AND HANDLING CAUTIONS* stated below to avoid breaker performance deterioration and/or damage to the breaker body or terminal.

DESIGN CAUTIONS

1. Use within the electrical ratings specified in this data sheet. If used over the rating of voltage or current, ON-OFF life might be impacted and contact may deteriorate due to breaker arm damage.
2. If used over the electrical rating, the circuit may not open safely or operate properly. Please test your device for any abnormalities and confirm that the breaker will open the circuit safely in your device.
3. Mount the breaker on your device where heat is the highest in order to transfer it effectively to the breaker.
4. If the breaker is affixed with an adhesive (resin, etc.), fully test, evaluate and verify that the adhesive presents no negative effects on the breaker before proceeding.
5. After the breaker is mounted, affix it so that the breaker body and terminals will not move. If not affixed properly, breaker resistance could increase or contact could open due to stress during handling or vibration/shock during transportation.
6. Mount the breaker body and terminals in a straight and flat direction. If the body and terminals are mounted in a twisted condition, breaker resistance could increase or create body damage.
7. If breaker is to be resin-molded, test and evaluate the application to determine whether the breaker can be used effectively.
8. The breaker cannot be used as a repetitive ON-OFF thermostat.
9. The breaker is not washable. Do not wash.
10. The breaker is not designed or warranted for flow, reflow or hand-soldering applications. If such application is required, you will need to evaluate whether the breaker is suitable for your specific application.
11. When mounting and after mounting the breaker, do not apply supersonic vibration. Vibration and heat may cause breaker resistance to increase or may cause body damage. If you plan to apply supersonic vibration after mounting the breaker, you will need to evaluate whether the breaker is suitable for your specific application. The breaker is not designed or warranted to withstand supersonic vibration.
12. Do not use the breaker in the following environments:
 - a) Water, oil, chemicals or organic solutions
 - b) Direct sunlight, outdoor exposure, dust
 - c) Dew condensation, allowing the breaker to get wet
 - d) Salt breeze, chlorine, hydrogen sulfide, ammonium, sulfide-oxidation, hydrogen chloride, and anywhere there is a possibility of generating corrosive gas such as sulfuric acid gas
 - e) Strong static electric charge or electromagnetic wave
13. The breaker is not designed or tested for, and should not be used in, aerospace, airplane, nuclear, military, life-sustaining medical and other related applications.

Specifications are subject to change without notice.

The device characteristics and parameters in this data sheet can and do vary in different applications and actual device performance may vary over time. Users should verify actual device performance in their specific applications.

Caution when using Breaker (Continued)

HANDLING CAUTIONS

1. Since the breaker body is composed of plastic parts, do not clamp or dent with tools as this could cause a resistance increase or body damage.
2. Breaker terminals are thin copper-alloy with right angle edges. Handle carefully to avoid injury to fingers. Handling while wearing finger cots and using tweezers is recommended.
3. When welding breaker terminals or mounting the breaker on a cell or PCM board, be careful to avoid placing excessive stress on the breaker body and terminals. Excessive stress may cause a resistance increase or body damage. Please refer to the following cautions:
 - a) Do not apply more than 10 N moment to the breaker body (refer to Figure 1)
 - b) Do not apply more than 1.5 cN-m twist torque to the breaker body (refer to Figure 2)
 - c) Do not apply more than 20 N bending force to the breaker body (refer to Figure 3)
 - d) Do not apply more than 2.0 cN-m twist torque to the breaker terminals (refer to Figure 4)
 - e) Do not apply more than 2 N force to the breaker terminals (refer to Figure 5)
 - f) Do not bend terminals more than 45 ° at root (refer to Figure 6)
 - g) Do not twist terminals more than 10 ° with the breaker body affixed.
4. In breaker body welding, normally there is direct welding (Figure 7) and series welding (Figure 8). In either case, use a suitable jig so that stress will not exceed the limits stated above.
5. Pull-and-detach strength of the terminal welding should be to your own specification. If the welding result is controlled by resistance, measurement should be made at a close point to the breaker body by "DC 4-point clip method" using a milliohm meter to ensure accuracy (refer to Figure 9).
6. Avoid putting excessive stress as shown above in 3-a) to 3-g) when the jig is used for welding/additional processing.
7. Confirm the resistance value after each time an additional process is applied.

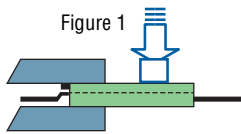

Figure 1

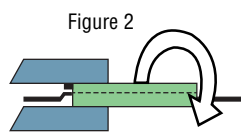

Figure 2

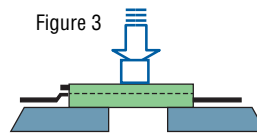

Figure 3

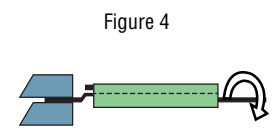

Figure 4

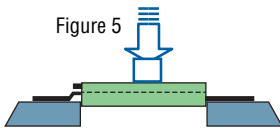

Figure 5

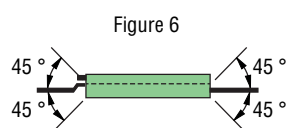

Figure 6

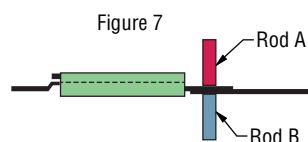

Figure 7

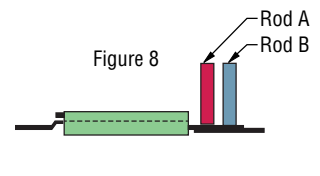

Figure 8

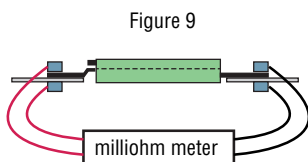

Figure 9

Due to possible updates to safety standards and other reasons, there may be changes in specifications for this data sheet without prior notification. Therefore, before design-in for your application, please contact us for the most up-to-date specifications.