

REV.	DESCRIPTION	DATE
A	RELEASE	2016.06.08

RoHS

**MATERIAL&FINISH**

Insulator: PBT Glass Fiber (UL94V-0)  
 Contact Material: Terminal Brass.  
 Contact Plating : Terminal Shell  
 Spec. Gold-Plated Over Nickel.

**SPECIFICATIONS**

Current Rating : 1A AC, DC  
 Voltage Rating : 250V AC, DC  
 Temperature Range: -40° C To +105° C  
 Contact Resistance: 20MΩ Max  
 Insulation Resistance: 1000MΩ Min  
 Withstanding Voltage: 500V AC/Min

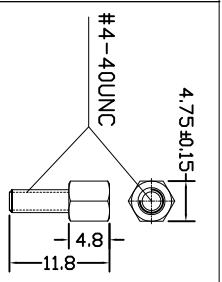
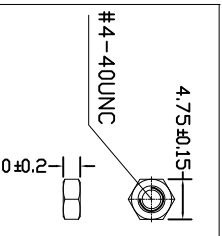
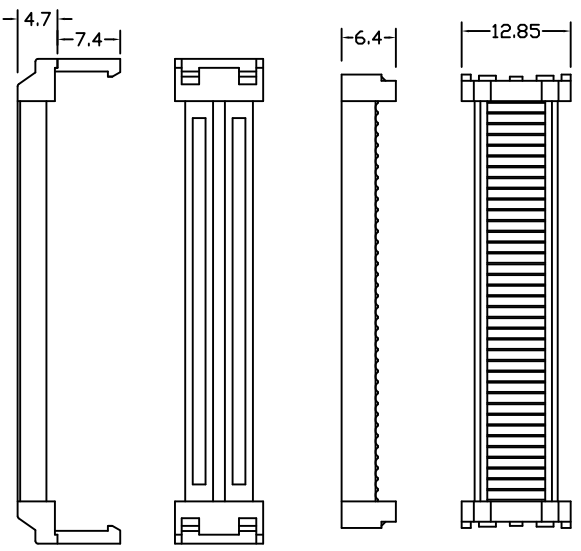
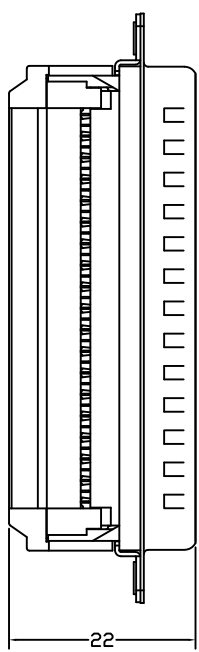
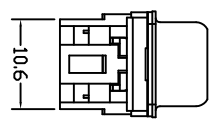
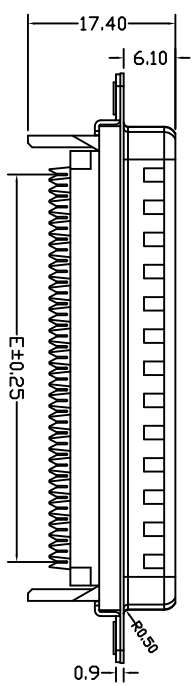
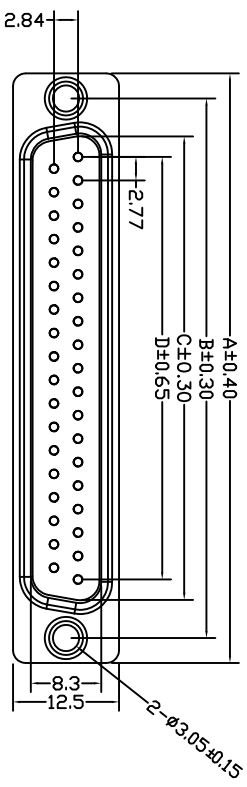

NUMBER OF POSITIONS	DIMENSION				
	A	B	C	D	E
9	30.80	25.00	16.95	11.08	10.16
15	39.14	33.30	25.3	19.39	17.78
25	53.05	47.04	38.96	33.24	30.48
37	69.32	63.50	55.42	49.86	45.72

UNLESS TOLERANCE

GENERAL	ANGLE	DESIGN BY	CHECK BY	APPROVE BY
X. ± 0.30	X°. ± 3.0°			
.XX ± 0.20	.X°. ± 2.0°			
.XXX ± 0.15	.XX°. ± 1.0°			
.XXX ± 0.08	.XXX ± 0.5°			

SCALE	SHEET	UNIT
1:1	1/1	MM

**CnC Tech,LLC**

Part NO.  
400MD-XX-1-004S

DRAW NO: REV: A