

Connecting cables, universal

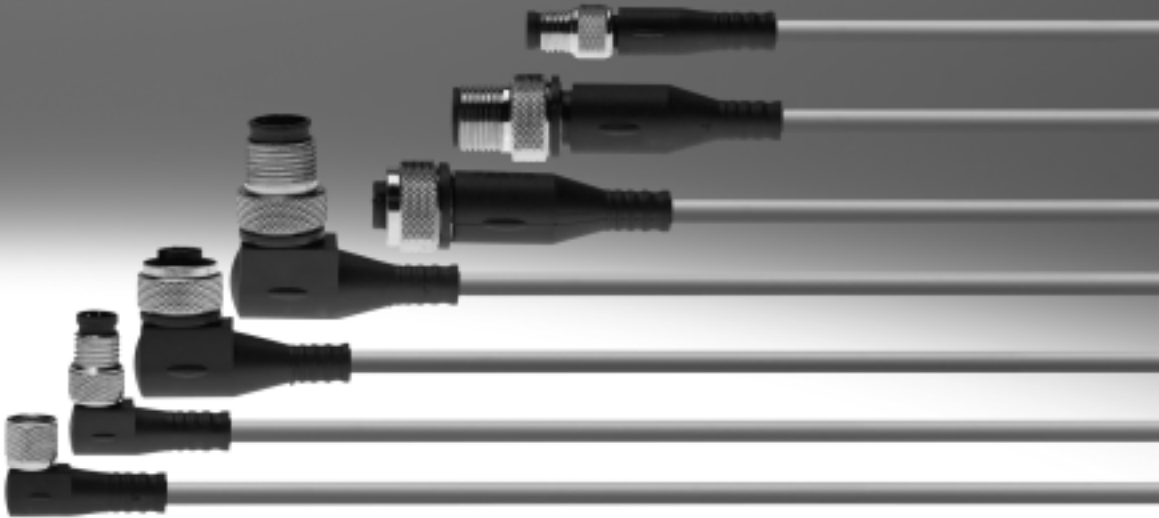

Connecting cables, universal

Key features

FESTO

Cable characteristics

The connecting cables NEBU can be configured and ordered using the modular system. This is done by defining a series of characteristics. These include:

- Electrical connection
- Cable characteristics
- Length
- Number of pins/wires

The cable characteristics specify the resistance of the connecting cable to mechanical loads.

There are four quality classes:

- Basic
- Standard
- Suitable for use with energy chains
- Suitable for robot applications

Cable characteristics: Basic

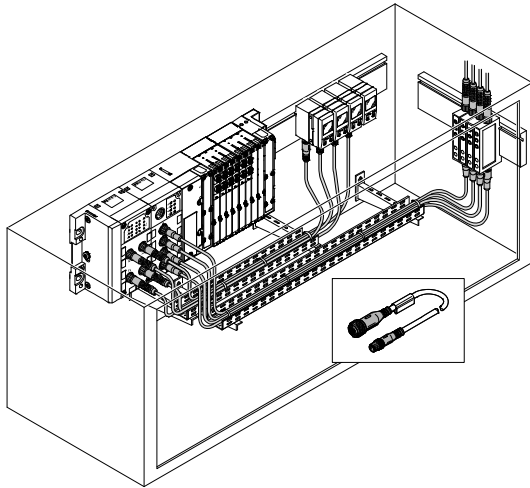

Code P

Basic applications are characterised by fixed cable installation with no mechanical loads.

The connecting cable is not continuously moving (kinked or twisted).

The cable sheath of the connecting cables is usually made from PVC.

- The resistance to bending of the connecting cable is tested in accordance with the Festo standard; the test conditions are available on request.

Cable characteristics: Standard

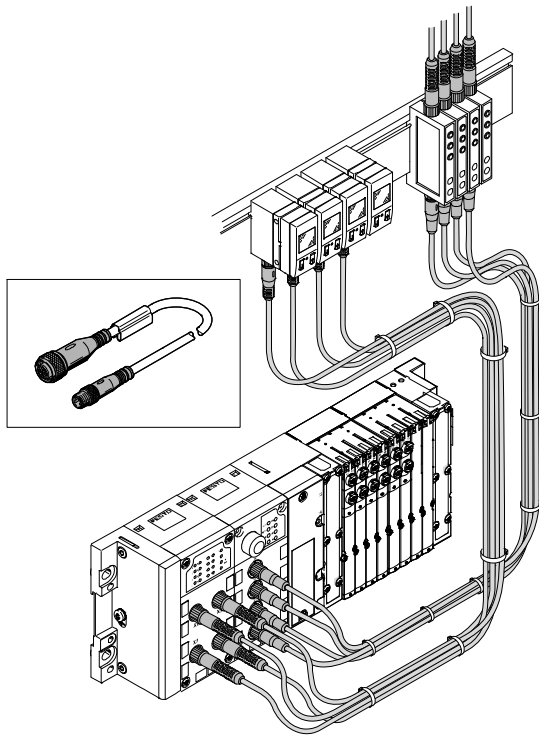

Code K

Standard applications are characterised by fixed cable installation or small to medium mechanical loads.

The connecting cable can even be used for simple energy chain applications with large radii.

The cable sheath of the connecting cables is made from polyurethane.

- The resistance to bending of the connecting cable is tested in accordance with the Festo standard; the test conditions are available on request.
- The connecting cable is tested for energy chains with 5 million cycles, bending radius 75 mm.

Connecting cables, universal

Key features

FESTO

Cable characteristics

Cable characteristics: Suitable for use with energy chains

Code E

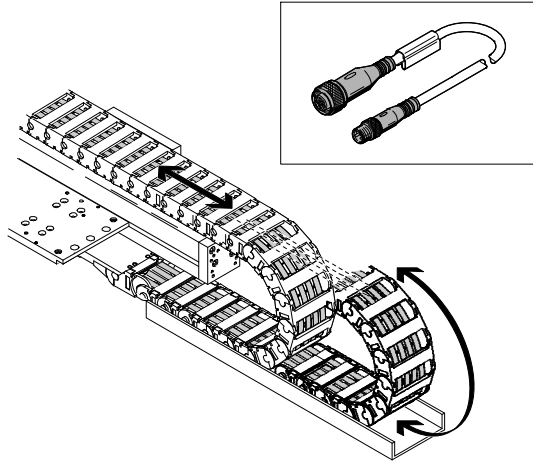

Energy chain applications involve high mechanical loads, particularly if the energy chains have small radii. It is possible that the connecting cable may be used in an environment where it is subject to continuous bending. The cable sheath of the connecting cables is made from polyurethane.

- The resistance to bending of the connecting cable is tested in accordance with the Festo standard; the test conditions are available on request.
- The connecting cable is tested for energy chains with 5 million cycles, bending radius 75 mm.
- The connecting cable is tested for energy chains with 5 million cycles, bending radius 28 mm.

Cable characteristics: Suitable for robot applications

Code R

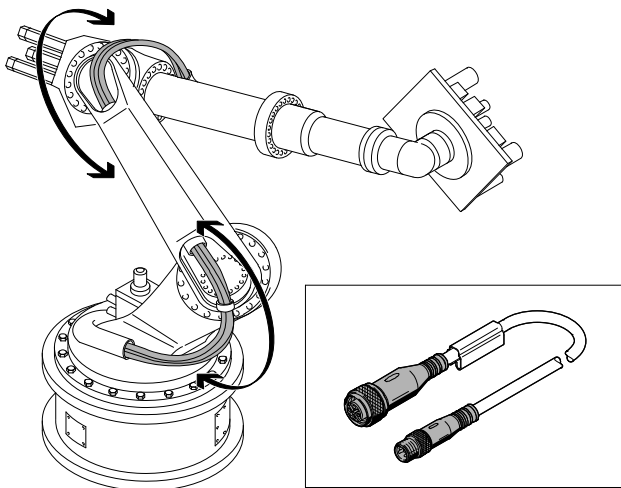

Robot applications involve high mechanical loads, mainly caused by torsion. The cable sheath of the connecting cables is made from polyurethane and is halogen-free and oil-resistant.

- The resistance to bending of the connecting cable is tested in accordance with the Festo standard; the test conditions are available on request.
- The connecting cable is tested for energy chains with 5 million cycles, bending radius 75 mm.
- The connecting cable is tested for energy chains with 5 million cycles, bending radius 28 mm.
- The connecting cable is tested for torsional strength with more than 0.3 million cycles, $\pm 270^\circ/0.1$ m.

Connecting cables, universal

Key features

FESTO

Connection technology types

Different types of plug connectors (e.g. angled or straight) can be chosen for the connecting cables.

A special type of connector is the rotatable type: this enables the cable outlet of an angled socket to be rotated by 360° in 15° increments.

Advantage:
This enables optimum positioning of the cable outlet in tight installation spaces.
The connectors are not designed for repeatedly changing the outlet direction.

Mounting

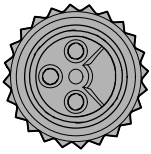

Note the orientation of the pins.

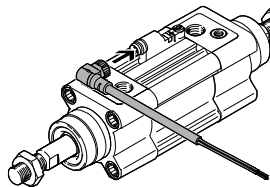

Place the socket on the plug.

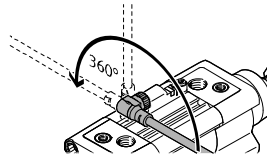

Adjust the cable outlet.

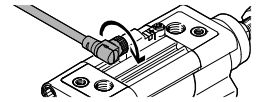

Tighten the union nut.

Connecting cables, universal

Product range overview

FESTO

Function	Version	Type	Connection technology (right-hand end)	Cable characteristics	Length	→ Page/ Internet
Electrical connecting cable	Electrical connection (left-hand end), open cable end					
	5-pin	NEBU-LE	Socket, plug	Standard	0.1 ... 30 m	8
	Electrical connection (left-hand end), socket M8					
	3-pin	NEBU-M8 SIM-M8	Plug, open cable end	Basic, standard, suitable for use with energy chains, suitable for robot applications	0.1 ... 30 m	10
	4-pin	NEBU-M8 SIM-M8	Plug, open cable end	Basic, standard, suitable for use with energy chains, suitable for robot applications	0.1 ... 30 m	16
	Electrical connection (left-hand end), socket M12					
	3-pin	SIM-M12-3 SIM-M12-RS-3	Plug, open cable end	Standard	0.6 m, 2.5 m, 3 m, 5 m	21
	5-pin	NEBU-LE5 NEBU-M12G5 NEBU-M12W5 SIM-M12-5	Plug, open cable end	Basic, standard, suitable for use with energy chains, suitable for robot applications	0.1 ... 30 m	24
	8-pin	NEBU-M12-W8 SIM-M12-8 KM12-8	Plug, open cable end	Standard	2 m, 5 m, 10 m	30
	Electrical connection (left-hand end), socket 7/8"					
	5-pin	NEBU-G78	Open cable end	Standard	2 m	33
	Electrical connection (left-hand end), clip					
	3-pin	SIM-K	Open cable end	Standard	2.5 m, 5 m, 10 m	35
	4-pin	SIM-K-4	Open cable end	Standard	2.5 m, 5 m	37

Connecting cables NEBU, universal

Type codes

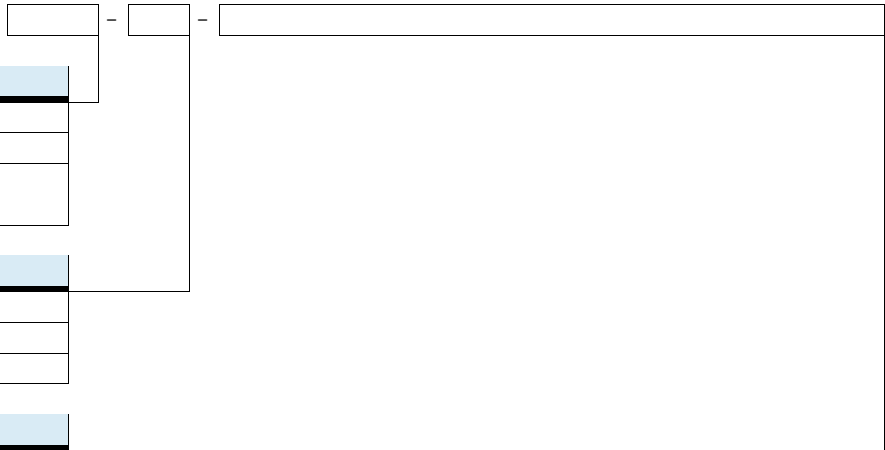

Connection technology, right-hand end

LE	Open cable end
M8	Plug with connecting thread M8
M12	Plug with connecting thread M12, A-coded

Connection technology type at right-hand end

	Open cable end
G	Straight
W	Angled

Number of pins/wires (right-hand end)

2	2-pin
3	3-pin
4	4-pin
5	5-pin
8	8-pin

Connecting cables, open cable end, 5-pin

Technical data

Connecting cable
NEBU-LE5

- Plug socket with cable for connecting inputs/outputs
- Pre-assembled
- Cable length 1 m
- 5 wires
- Plug M12



General technical data	
Conforms to standard	EN 61984 EN 61076-2-101
Plug coding	A
Cable composition	[mm ²] 5x 0.25
Cable diameter	[mm] 4.5
Nominal conductor cross section	[mm ²] 0.25
Cable characteristics	Standard
Cable test conditions	Resistance to bending: to Festo standard Test conditions on request Energy chain: 5 million cycles, bending radius 75 mm

Technical data			
Operating voltage range	[V]	0 ... 60 DC	0 ... 60 AC
Acceptable current load	[A]	4	
Surge resistance	[kV]	1.5	
Protection class to EN 60529		IP65, IP68, IP69K	

Materials	
Wire colour	Blue, brown, grey, black, white
Housing colour	Black
Cable sheath colour	Grey
Housing	TPE-U(PU)
Insulating sheath	PP
Union nut	Nickel-plated brass
Cable sheath	TPE-U(PU)
Note on materials	RoHS-compliant

Operating and environmental conditions		
Ambient temperature	[°C]	-25 ... +70
Ambient temperature with flexible cable installation	[°C]	-5 ... +70
CE marking (see declaration of conformity)		In accordance with EU Low Voltage Directive
Degree of contamination		3

Connecting cables, open cable end, 5-pin

Technical data

Circuitry (socket view)				
Socket	Pin	Wire colour ¹⁾	Pin	Plug
Electrical connection: open cable end, 5-wire – plug, 5-pin, M12				
-	-	BN	1	
	-	WH	2	
	-	BU	3	
	-	BK	4	
	-	GY	5	

1) To IEC 757

Dimensions

Connection technology, left-hand end

2) Inscription label holder 3) Cable, length 1 m

Download CAD data → www.festo.com

Connection technology, right-hand end

1) Plug 2) Inscription label holder 3) Cable, length 1 m

Connection technology, left-hand end	L3
NEBU	
Open end	50

Connection technology, right-hand end	D1	D4	D5	L2	L3	L4	H1
	∅		∅				
NEBU							
Straight plug	4.5	M12x1	15	54.5	-	23	-

Ordering data						
	Cable length [m]	Cable characteristics	Outlet direction	Special features	Part No.	Type
Open cable end, 5-wire – plug, 5-pin, M12						
	1	Standard	Straight	-	569840	NEBU-LE5-K-1-M12G5

Connecting cables, M8, 3-pin

Technical data

Connecting cable
NEBU-M8
SIM-M8

- Plug socket with cable for connecting inputs/outputs
- Pre-assembled at both ends
- Cable lengths 0.1 ... 30 m
- 3 wires
- M8



General technical data			
Conforms to standard		EN 61076-2-104	
		EN 61984	
		EN 61076-2-101	
Cable composition		[mm ²]	3x 0.25
Cable diameter		[mm]	4.5
Nominal conductor cross section		[mm ²]	0.25
Cable characteristics	NEBU	Code -P-	Basic
		Code -K-	Standard
		Code -E-	Suitable for use with energy chains
		Code -R-	Suitable for robot applications
	SIM		Standard
Cable test conditions		Resistance to bending: to Festo standard	
		Test conditions on request	
Cable characteristics	SIM	Basic	-
		Standard	Energy chain: 5 million cycles, bending radius 75 mm
		Suitable for use with energy chains	Energy chain: 5 million cycles, bending radius 28 mm
		Suitable for robot applications	Torsional strength greater than 300,000 cycles, ±270°/0.1 m

Technical data				
Operating voltage range	Without display	[V]	0 ... 60 DC	0 ... 60 AC
	With display	[V]	10 ... 30 DC	-
Acceptable current load	Non-rotatable connection technology	[A]	3	
	Rotatable connection technology	[A]	0.5	
Surge resistance	Non-rotatable connection technology, without switching status display	[kV]	1.5	
	Rotatable connection technology	[kV]	0.8	
	With switching status display	[kV]	0.8	
Protection class to EN 60529	SIM		IP65, IP68	
	NEBU		IP65, IP68, IP69K	

Connecting cables, M8, 3-pin

Technical data

Materials		
Wire colour		Blue, brown, black
Housing colour		Black
Cable sheath colour		Grey
Housing		TPE-U(PU)
Insulating sheath	Cable characteristics: standard, suitable for energy chains and robot applications	PP
	Cable characteristics: basic, standard	PVC-P
Union nut		Nickel-plated brass
Cable sheath	Cable characteristics: standard, suitable for energy chains and robot applications	TPE-U(PU)
	Cable characteristics: basic	PVC-P
Note on materials	All types	RoHS-compliant
	Cable characteristics: suitable for energy chains and robot applications	Halogen-free
Special features	NEBU Cable characteristics: suitable for energy chains and robot applications	Oil-resistant

Operating and environmental conditions		
Ambient temperature	Cable characteristics: basic, standard [°C]	-25 ... +70
	Cable characteristics: suitable for energy chains and robot applications [°C]	-25 ... +80
Ambient temperature with flexible cable installation	Cable characteristics: standard [°C]	-5 ... +70
	Cable characteristics: basic, suitable for energy chains and robot applications [°C]	-5 ... +80
CE marking (see declaration of conformity)	With switching status display	-
	Without switching status display	In accordance with EU Low Voltage Directive
Degree of contamination		3

Connecting cables, M8, 3-pin

Technical data

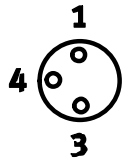
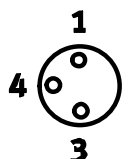
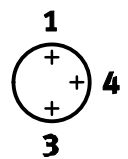
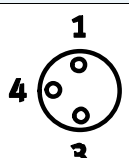
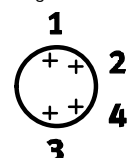
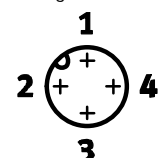
Circuitry (socket view)					
Socket	Pin	Wire colour ¹⁾	Pin	Plug	
Electrical connection: socket, 3-pin, M8 – open cable end					
	1	BN	-	-	
	3	BU	-		
	4	BK	-		
Electrical connection: socket, 3-pin, M8 – plug, 3-pin					
	1	BN	1		
	3	BU	3		
	4	BK	4		
Electrical connection: socket, 3-pin, M8 – plug, 4-pin					
	1	BN	1	Plug M8 	Plug M12 
	-	-	2		
	3	BU	3		
	4	BK	4		

1) To IEC 757

Circuitry – Switching status display

Display code P
For NPN N/O contact

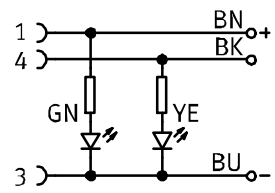

Display code N
For PNP N/O contact

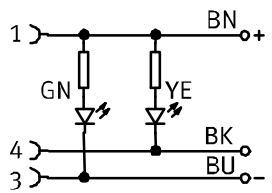

Connecting cables, M8, 3-pin

Technical data

Dimensions

Download CAD data → www.festo.com

Connection technology, left-hand end

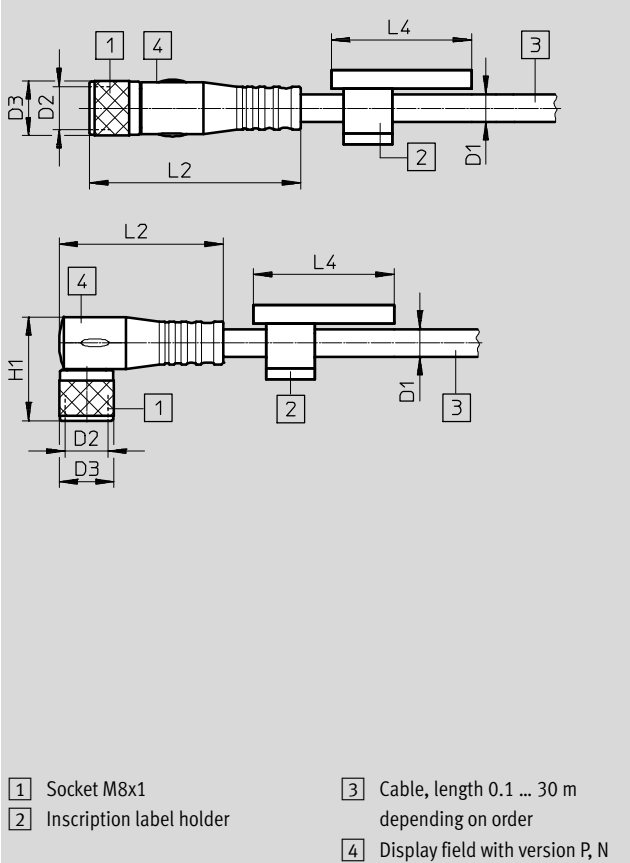

- 1 Socket M8x1
- 2 Inscription label holder
- 3 Cable, length 0.1 ... 30 m depending on order
- 4 Display field with version P, N

Connection technology, right-hand end

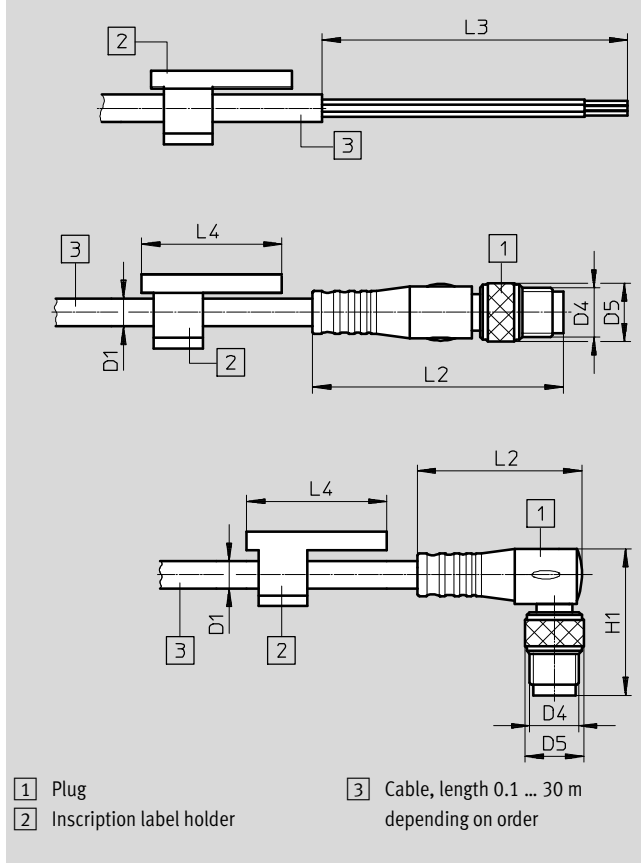

- 1 Plug
- 2 Inscription label holder
- 3 Cable, length 0.1 ... 30 m depending on order



Connection technology, left-hand end	D1 Ø	D2	D3 Ø	L2	L4	H1
NEBU						
Straight socket	4.5	M8x1	9	34.6	23	-
Angled socket	4.5	M8x1	9	26.9	23	17
Rotatable socket	4.5	M8x1	10	20.9	23	16.3
NEBU with display						
Straight socket	3.4	M8x1	9	34.6	23	-
Angled socket	3.4	M8x1	9	26.9	23	17
SIM						
Straight socket	4.5	M8x1	9	34.4	-	-
Angled socket	4.5	M8x1	9	26.8	-	16.8

Connection technology, right-hand end	D1 Ø	D4	D5 Ø	L2	L3	L4	H1
NEBU							
Open end	4.5	-	-	-	50	23	-
Straight plug	4.5	M8x1	9.6	41.1	-	23	-
	4.5	M12x1	15	54.5	-	23	-
Angled plug	4.5	M8x1	9.6	26.9	-	23	24
	4.5	M12x1	15	37.5	-	23	33.2
NEBU with display							
Straight plug	3.4	M8x1	9	41.1	-	23	-
	3.4	M12x1	15	54.5	-	23	-
Angled plug	3.4	M8x1	9	26.9	-	23	24
	3.4	M12x1	15	37.5	-	23	33.2
SIM							
Open end	4.5	-	-	-	50	-	-

Connecting cables, M8, 3-pin

Technical data

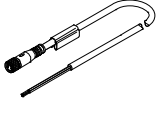
FESTO

Ordering data								
	Cable length [m]	Cable characteristics	Outlet direction	Special features	Part No.	Type		
Socket, 3-pin, M8 – open cable end								
	2.5	Standard	Straight	–	541333	NEBU-M8G3-K-2.5-LE3		
				–	159420	SIM-M8-3GD-2,5-PU		
			Angled	–	541338	NEBU-M8W3-K-2.5-LE3		
				–	159422	SIM-M8-3WD-2,5-PU		
				Rotatable socket	8001660	NEBU-M8R3-K-2.5-LE3		
				For NPN N/O contact, yellow switching status display, green ready status display	541336	NEBU-M8W3N-K-2.5-LE3		
				–	159426	SIM-M8-3WD-2,5-NSL-PU		
				For PNP N/O contact, yellow switching status display, green ready status display	541337	NEBU-M8W3P-K-2.5-LE3		
			–	159424	SIM-M8-3WD-2,5-PSL-PU			
			Suitable for robot applications	Straight	Oil-resistant	569845	NEBU-M8G3-R-2.5-LE3	
				Angled	Oil-resistant	569847	NEBU-M8W3-R-2.5-LE3	
			5	Standard	Straight	–	541334	NEBU-M8G3-K-5-LE3
						–	159421	SIM-M8-3GD-5-PU
					Angled	–	541341	NEBU-M8W3-K-5-LE3
	–	159423				SIM-M8-3WD-5-PU		
	Rotatable socket	8001661				NEBU-M8R3-K-5-LE3		
	For NPN N/O contact, yellow switching status display, green ready status display	541339				NEBU-M8W3N-K-5-LE3		
	–	159427				SIM-M8-3WD-5-NSL-PU		
	For PNP N/O contact, yellow switching status display, green ready status display	541340				NEBU-M8W3P-K-5-LE3		
	–	159425			SIM-M8-3WD-5-PSL-PU			
	Suitable for use with energy chains	Straight			Oil-resistant	569843	NEBU-M8G3-E-5-LE3	
	Suitable for robot applications	Straight			Oil-resistant	569846	NEBU-M8G3-R-5-LE3	
	10	Standard			Straight	–	541332	NEBU-M8G3-K-10-LE3
						–	192964	SIM-M8-3GD-10-PU
					Angled	–	541335	NEBU-M8W3-K-10-LE3
			–	192965		SIM-M8-3WD-10-PU		
			Suitable for use with energy chains	Straight	Oil-resistant	569842	NEBU-M8G3-E-10-LE3	
			Suitable for robot applications	Straight	Oil-resistant	8003129	NEBU-M8G3-R-10-LE3	
Socket, 3-pin, M8 – plug, 3-pin, M8								
		0.5	Standard	Straight – straight	–	541346	NEBU-M8G3-K-0.5-M8G3	
		1	Standard	Straight – straight	–	541347	NEBU-M8G3-K-1-M8G3	
		1.5	Standard	Straight – straight	–	8003133	NEBU-M8G3-K-1.5-M8G3	
	2	Standard	Straight – straight	–	8003131	NEBU-M8G3-K-2-M8G3		
	2.5	Standard	Straight – straight	–	541348	NEBU-M8G3-K-2.5-M8G3		
	3	Standard	Straight – straight	–	8003132	NEBU-M8G3-K-3-M8G3		
	3.5	Suitable for use with energy chains	Straight – straight	Oil-resistant	559364	NEBU-M8G3-E-3.5-M8G3		
	5	Standard	Straight – straight	–	541349	NEBU-M8G3-K-5-M8G3		
	10	Standard	Straight – straight	–	569844	NEBU-M8G3-K-10-M8G3		

Connecting cables, M8, 3-pin

Technical data

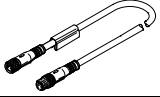
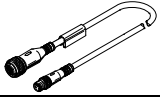
Ordering data						
	Cable length [m]	Cable characteristics	Outlet direction	Special features	Part No.	Type
Socket, 3-pin, M8 – plug, 4-pin, M8						
	2.5	Standard	Straight – straight	–	554037	NEBU-M8G3-K-2.5-M8G4
Socket, 3-pin, M8 – plug, 3-pin, M12						
	0.5	Standard	Straight – straight	–	8000209	NEBU-M8G3-K-0.5-M12G3

Connecting cables, M8, 4-pin

Technical data

Connecting cable
NEBU-M8
SIM-M8

- Plug socket with cable for connecting inputs/outputs
- Pre-assembled at both ends
- Cable lengths 0.1 ... 30 m
- 4 wires
- M8



General technical data				
Conforms to standard				EN 61076-2-104
				EN 61984
				EN 61076-2-101
Cable composition			[mm ²]	4x 0.25
Cable diameter	NEBU	With display	[mm]	3.4
		Without display	[mm]	4.5
	SIM		[mm]	4.5
Nominal conductor cross section			[mm ²]	0.25
Cable characteristics	NEBU	Code -P-		Basic
		Code -K-		Standard
		Code -E-		Suitable for use with energy chains
		Code -R-		Suitable for robot applications
	SIM			Standard
Cable test conditions				Resistance to bending: to Festo standard
				Test conditions on request
	Cable characteristics	Basic		-
		Standard		Energy chain: 5 million cycles, bending radius 75 mm
		Suitable for use with energy chains		Energy chain: 5 million cycles, bending radius 28 mm
		Suitable for robot applications		Torsional strength greater than 300,000 cycles, ±270°/0.1 m

Technical data					
Operating voltage range	NEBU	Without display	[V]	0 ... 30 DC	0 ... 30 AC
		With display	[V]	21.6 ... 30 DC	21.6 ... 30 AC
	SIM		[V]	0 ... 30 DC	0 ... 30 AC
Acceptable current load			[A]	3	
Surge resistance	NEBU		[kV]	0.8	
	SIM		[kV]	0.8	
Protection class to EN 60529	NEBU			IP65, IP68, IP69K	
	SIM			IP65, IP68	

Connecting cables, M8, 4-pin

Technical data

Materials		
Wire colour		Blue, brown, black, white
Housing colour		Black
Cable sheath colour		Grey
Housing		TPE-U(PU)
Insulating sheath	Cable characteristics: standard, suitable for energy chains and robot applications	PP
	Cable characteristics: basic, standard	PVC-P
Union nut		Nickel-plated brass
Cable sheath	Cable characteristics: standard, suitable for energy chains and robot applications	TPE-U(PU)
	Cable characteristics: basic	PVC-P
Note on materials		RoHS-compliant
	Cable characteristics: suitable for energy chains and robot applications	Halogen-free
Special features	Cable characteristics: suitable for energy chains and robot applications	Oil-resistant

Operating and environmental conditions			
Ambient temperature	Cable characteristics: basic, standard	[°C]	-25 ... +70
	Cable characteristics: suitable for energy chains and robot applications	[°C]	-25 ... +80
Ambient temperature with flexible cable installation	Cable characteristics: standard	[°C]	-5 ... +70
	Cable characteristics: basic, suitable for energy chains and robot applications	[°C]	-5 ... +80
Degree of contamination			3

Connecting cables, M8, 4-pin

Technical data

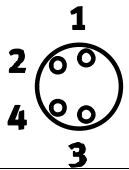
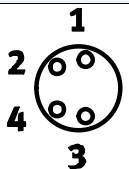
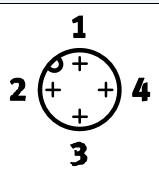
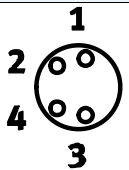
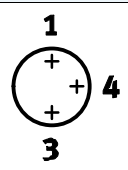
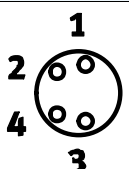
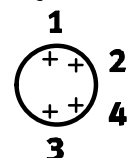
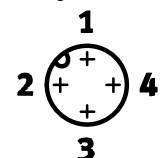
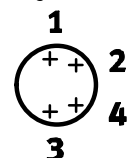
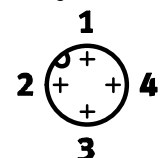
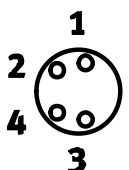
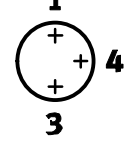
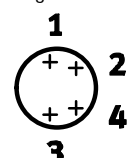
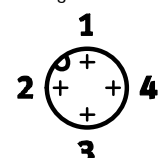
Circuitry (socket view)					
Socket	Pin	Wire colour ¹⁾	Pin	Plug	
Electrical connection: socket, 4-pin, M8 – open cable end					
	1	BN	-	-	
	2	WH	-	-	
	3	BU	-	-	
	4	BK	-	-	
Electrical connection: socket, 4-pin, M8 – plug, 2-pin					
	1	BN	-		
	2	WH	-		
	3	BU	3		
	4	BK	4		
Electrical connection: socket, 4-pin, M8 – plug, 3-pin					
	1	BN	1		
	2	WH	-		
	3	BU	3		
	4	BK	4		
Electrical connection: socket, 4-pin, M8 – plug, 4-pin					
	1	BN	1		
	2	WH	2		
	3	BU	3		
	4	BK	4		
Electrical connection: socket, 4-pin, M8, with display code L					
	1	-	1	Open cable end	
	2	-	2		
	3	BK	3		
	4	BK	4		

1) To IEC 757

Circuitry – Switching status display

Display code L

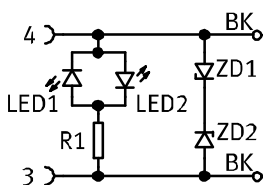

Connecting cables, M8, 4-pin

Technical data

Dimensions

Download CAD data → www.festo.com

Connection technology, left-hand end

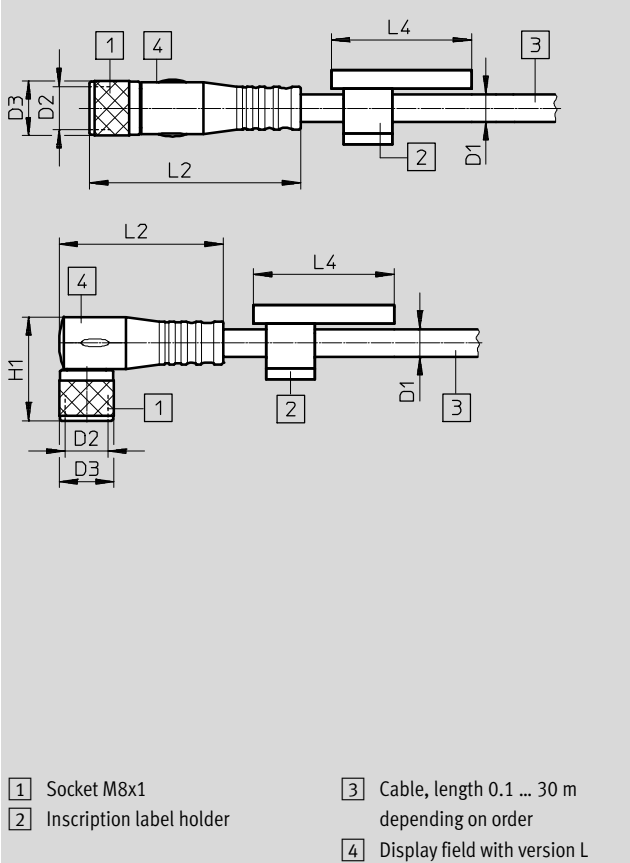

- 1 Socket M8x1
- 2 Inscription label holder
- 3 Cable, length 0.1 ... 30 m depending on order
- 4 Display field with version L

Connection technology, right-hand end

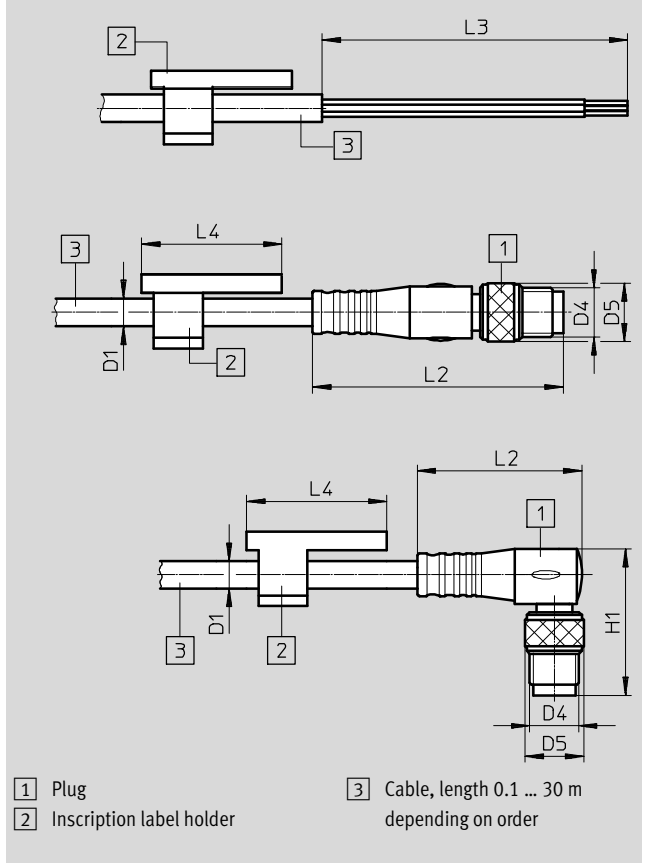

- 1 Plug
- 2 Inscription label holder
- 3 Cable, length 0.1 ... 30 m depending on order

Connection technology, left-hand end	D1 ∅	D2	D3 ∅	L2	L4	H1
NEBU						
Straight socket	4.5	M8x1	9	34.6	23	–
Angled socket	4.5	M8x1	9	26.9	23	17
Rotatable socket	4.5	M8x1	10	20.9	23	16.3
NEBU with display						
Straight socket	3.4	M8x1	9	34.6	23	–
Angled socket	3.4	M8x1	9	26.9	23	17
SIM						
Straight socket	4.5	M8x1	9	34.4	–	16.8
Angled socket	4.5	M8x1	9	26.8	–	16.8

Connection technology, right-hand end	D1 ∅	D4	D5 ∅	L2	L3	L4	H1
NEBU							
Open end	4.5	–	–	–	50	23	–
Straight plug	4.5	M8x1	9.6	41.1	–	23	–
	4.5	M12x1	15	54.5	–	23	–
Angled plug	4.5	M8x1	9.6	26.9	–	23	24
	4.5	M12x1	15	37.5	–	23	33.2
NEBU with display							
Straight plug	3.4	M8x1	9	41.1	–	23	–
	3.4	M12x1	15	54.5	–	23	–
Angled plug	3.4	M8x1	9	26.9	–	23	24
	3.4	M12x1	15	37.5	–	23	33.2
SIM							
Open end	4.5	–	–	–	50	–	–

Connecting cables, M8, 4-pin

Technical data

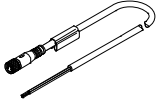
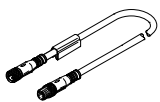
Ordering data						
	Cable length [m]	Cable characteristics	Outlet direction	Special features	Part No.	Type
Socket, 4-pin, M8 – open cable end						
	2.5	Standard	Straight	–	541342	NEBU-M8G4-K-2.5-LE4
					158960	SIM-M8-4GD-2,5-PU
			Angled	–	541344	NEBU-M8W4-K-2.5-LE4
				–	158962	SIM-M8-4WD-2,5-PU
	5	Standard	Straight	–	541343	NEBU-M8G4-K-5-LE4
				–	158961	SIM-M8-4GD-5-PU
			Angled	–	541345	NEBU-M8W4-K-5-LE4
				–	158963	SIM-M8-4WD-5-PU
	9	Standard	Straight	–	8003130	NEBU-M8G4-K-9-LE4
	10	Standard	Angled	–	575833	NEBU-M8W4-K-10-LE4
Socket, 4-pin, M8 – plug, 4-pin, M8						
	2	Suitable for robot applications	Straight – straight	Oil-resistant	556946	NEBU-M8G4-R-2-M8G4
	2.5	Standard	Straight – straight	–	554035	NEBU-M8G4-K-2.5-M8G4

Connecting cables, M12, 3-pin

Technical data

Connecting cable
SIM-M12

- Plug socket with cable for connecting inputs/outputs
- Pre-assembled
- Cable lengths 2.5 m, 3 m, 5 m
- 3 wires
- M12



General technical data	
Conforms to standard	EN 61984 EN 61076-2-101
Plug coding	A
Cable composition	[mm ²] 3x 0.25
SIM-...-RS	[mm ²] 3x 0.5
Cable diameter	[mm] 4.5
SIM-...-RS	[mm] 5.2
Nominal conductor cross section	[mm ²] 0.25
Cable characteristics	Standard
Cable test conditions	Resistance to bending: to Festo standard Test conditions on request Energy chain: 5 million cycles, bending radius 75 mm

Technical data				
Operating voltage range	Without switching status display	[V]	0 ... 250 DC	0 ... 250 AC
	With switching status display	[V]	10 ... 30 DC	–
	SIM-...-RS	[V]	0 ... 70 DC	0 ... 45 AC
Acceptable current load		[A]	4	
Surge resistance	Without switching status display	[kV]	2.5	
	With switching status display	[kV]	0.8	
	SIM-...-RS	[kV]	2.5	
Protection class to EN 60529			IP65, IP68	
	SIM-...-RS		IP65, IP67	

Materials	
Wire colour	Blue, brown, black
Housing colour	Black
Cable sheath colour	Grey
SIM-...-RS	Orange
Housing	TPE-U(PU)
Insulating sheath	PVC
Union nut	Nickel-plated brass
Cable sheath	TPE-U(PU)
SIM-...-RS	PVC, radiation crosslinked
Note on materials	RoHS-compliant, free of copper and PTFE

Connecting cables, M12, 3-pin

Technical data

Operating and environmental conditions			
Ambient temperature		[°C]	-25 ... +70
	SIM-...-RS	[°C]	-25 ... +80
Ambient temperature with flexible cable installation		[°C]	-5 ... +70
	SIM-...-RS	[°C]	0 ... +80
CE marking (see declaration of conformity)	Without switching status display		In accordance with EU Low Voltage Directive
	SIM-...-RS		-
Degree of contamination			3

Circuitry (socket view)				
Socket	Pin	Wire colour ¹⁾	Pin	Plug
Electrical connection: socket, 3-pin, M12 – open cable end				
	1	BN	-	-
	2	-	-	
	3	BU	-	
	4	BK	-	
	5	-	-	

1) To IEC 757

Dimensions Download CAD data → www.festo.com

Connection technology, left-hand end

1 Socket M12x1 3 Cable, length 2.5 m, 3 m or 5 m depending on order
2 Inscription label holder 4 Display field with version PSL

Connection technology, right-hand end

2 Inscription label holder 3 Cable, length 2.5 m, 3 m or 5 m depending on order

Connection technology, left-hand end	D1	D2	D3	L2	L4	H1
SIM						
Straight socket	4.5	M12x1	15	48.5	-	-
Angled socket	4.5	M12x1	-	37.5	-	26
SIM-...-RS						
Straight socket	5.2	M12x1	15	38	-	-
Angled socket	5.2	M12x1	13.5	31	-	25

Connection technology, right-hand end	D1	L3
SIM		
Open end	4.5	50
SIM-...-RS		
Open end	5.2	50

Connecting cables, M12, 3-pin

Technical data

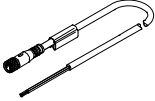
Ordering data						
	Cable length [m]	Cable characteristics	Outlet direction	Special features	Part No.	Type
Socket, 3-pin, M12 – open cable end						
	2.5	Standard	Straight	–	159428	SIM-M12-3GD-2,5-PU
			Angled	–	159430	SIM-M12-3WD-2,5-PU
				For NPN N/O contact, yellow switching status display, green ready status display	159434	SIM-M12-3WD-2,5-NSL-PU
	3	Standard	Straight	Resistant to welding spatter	30450	SIM-M12-RS-3GD-3
			Angled	Resistant to welding spatter	30451	SIM-M12-RS-3WD-3
	5	Standard	Straight	–	159429	SIM-M12-3GD-5-PU
			Angled	–	159431	SIM-M12-3WD-5-PU
				For NPN N/O contact, yellow switching status display, green ready status display	159435	SIM-M12-3WD-5-NSL-PU

Connecting cables, M12 5-pin

Technical data

Connecting cable

NEBU-M12

SIM-M12

- Plug socket with cable for connecting inputs/outputs
- Pre-assembled at both ends
- Cable lengths 0.1 ... 30 m
- 5 wires
- M12

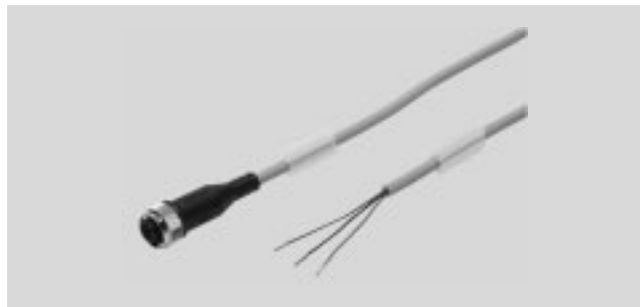

General technical data				
Conforms to standard		EN 61076-2-101		
		EN 61984		
		EN 61076-2-104		
Cable composition	2-wire	[mm ²]	2 x 0.25	
	3-wire	[mm ²]	3 x 0.25	
	4-wire	[mm ²]	4x 0.25	
	5-wire	[mm ²]	5 x 0.25	
	NEBU-M12G5-...-Q8N-M12G5	[mm ²]	5 x 1	
Cable diameter	NEBU/SIM	With display code L	[mm]	3.4
		Without display	[mm]	4.5
	NEBU-M12G5-...-Q8N-M12G5	[mm]	7	
Nominal conductor cross section	NEBU/SIM	[mm ²]	0.25	
	NEBU-M12G5-...-Q8N-M12G5	[mm ²]	1	
Cable properties	NEBU	Code -P-		Basic
		Code -K-		Standard
		Code -E-		Suitable for energy chains
		Code -R-		Suitable for robot applications
	SIM		Standard	
Cable test conditions				Bending strength: according to Festo standard
				Test conditions on request
	Cable properties	Basic		-
		Standard		Energy chain: 5 million cycles, bending radius 75 mm
		Suitable for energy chains		Energy chain: 5 million cycles, bending radius 28 mm
Suitable for robot applications			Torsional strength: > 300,000 cycles, ±270°/0.1 m	

Technical data					
Operating voltage range	NEBU/SIM	With plug M8	[V]	0 ... 30 DC	0 ... 30 AC
		3-wire, 4-wire	[V]	0 ... 250 DC	0 ... 250 AC
		5-wire	[V]	0 ... 60 DC	0 ... 60 AC
		With display code -P-, N or P2	[V]	10 ... 30 DC	-
Current-carrying capacity	NEBU/SIM	Other types	[A]	4	
		With plug M8	[A]	3	
Surge resistance			[kV]	1.5	
	With plug M8 4-pin or with switching status display		[kV]	0.8	
	With open cable end 3-pin or 4-pin		[kV]	2.5	
Degree of protection to EN 60529	SIM			IP65, IP68	
	NEBU			IP65, IP68, IP69K	

Connecting cables, M12 5-pin

Technical data

Materials		
Wire colours		Blue, brown, black, white, grey
Housing colour		Black
Cable sheath colour		Grey
Housing		TPE-U(PU)
Insulating sheath	Cable properties: suitable for use with energy chains, suitable for robot applications, standard	PP
	Cable property: basic	PVC-P
Union nut		Nickel-plated brass
Cable sheath	Cable properties: standard, suitable for use with energy chains, suitable for robot applications	TPE-U(PU)
	Cable property: basic	PVC
Note on materials		RoHS compliant
	Cable properties: suitable for use with energy chains, suitable for robot applications	Halogen-free
Special features	Cable properties: suitable for use with energy chains, suitable for robot applications	Oil-resistant

Operating and environmental conditions			
Ambient temperature	Cable properties: basic, standard	[°C]	-25 ... +70
	Cable properties: suitable for use with energy chains, suitable for robot applications	[°C]	-25 ... +80
Ambient temperature with flexible cable installation	Cable property: standard	[°C]	-5 ... +70
	Cable properties: basic, suitable for use with energy chains, suitable for robot applications	[°C]	-5 ... +80
CE marking (see declaration of conformity)	NEBU	With switching status display	To EU Low Voltage Directive
		Without switching status display	-
		With plug M8 4-pin	-
	NEBU-M12G5-...-Q8N-M12G5		To EU Low Voltage Directive
	SIM		To EU Low Voltage Directive
Degree of contamination			3

Connecting cables, M12 5-pin

Technical data

Wiring allocation (socket view)						
Socket	Pin	Wire colour ¹⁾			Pin	Plug
Electrical connection, socket, 5-pin, M12 – open cable end						
	1	3-wire	4-wire	5-wire	-	-
	2	-	WH	WH	-	-
	3	BU	BU	BU	-	-
	4	BK	BK	BK	-	-
	5	-	-	GY	-	-
Electrical connection, socket, 5-pin, M12 – cable 2-wire – plug, 4-pin						
	1		BN		1	
	2		-		-	
	3		BU		2	
	4		-		-	
	5		-		-	
Electrical connection, socket, 5-pin, M12 – cable 3-wire – plug, 3-pin/4-pin						
	1		BN		1	
	2		-		-	
	3		BU		3	
	4		BK		4	
	5		-		-	
Electrical connection, socket, 5-pin, M12 – plug, 4-pin						
	1		BN		1	
	2		WH		2	
	3		BU		3	
	4		BK		4	
	5		-		-	
Electrical connection, socket, 5-pin, M12 – plug, 5-pin						
	1		BN		1	
	2		WH		2	
	3		BU		3	
	4		BK		4	
	5		GY		5	

1) To IEC 757

Circuitry, switching status display

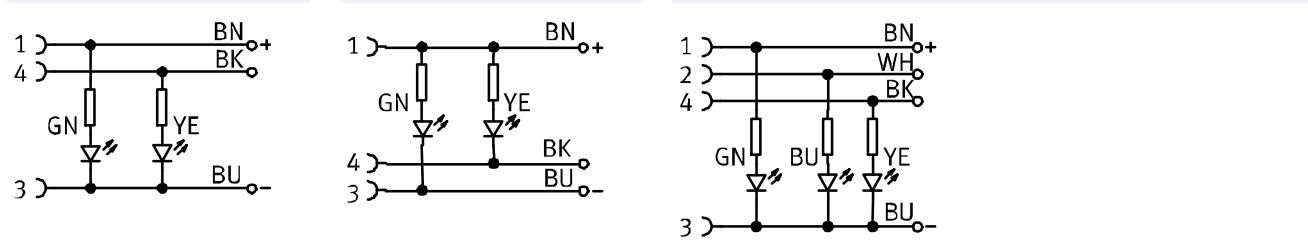

Connecting cables, M12 5-pin

Technical data

Dimensions

Download CAD data → www.festo.com

Connection technology, left

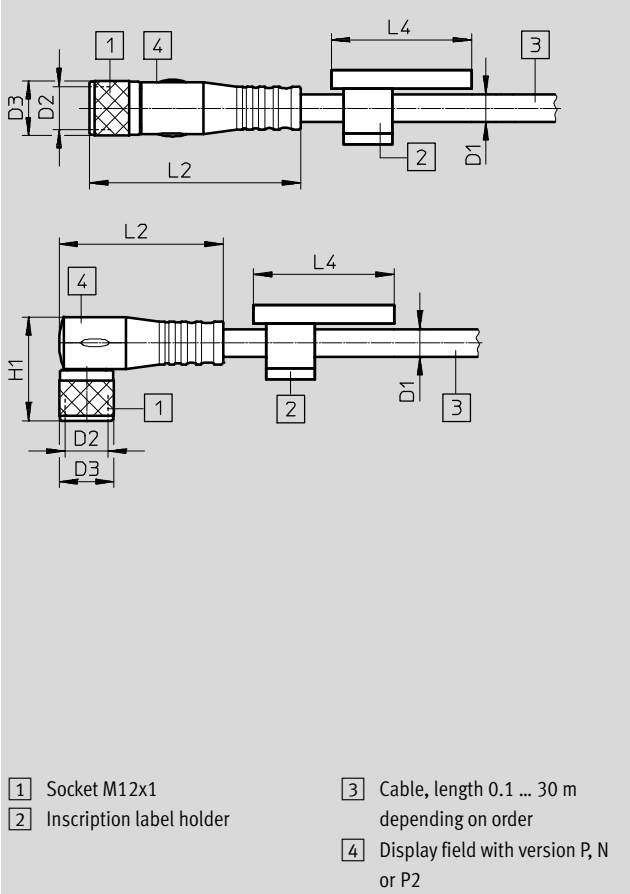

Connection technology, right

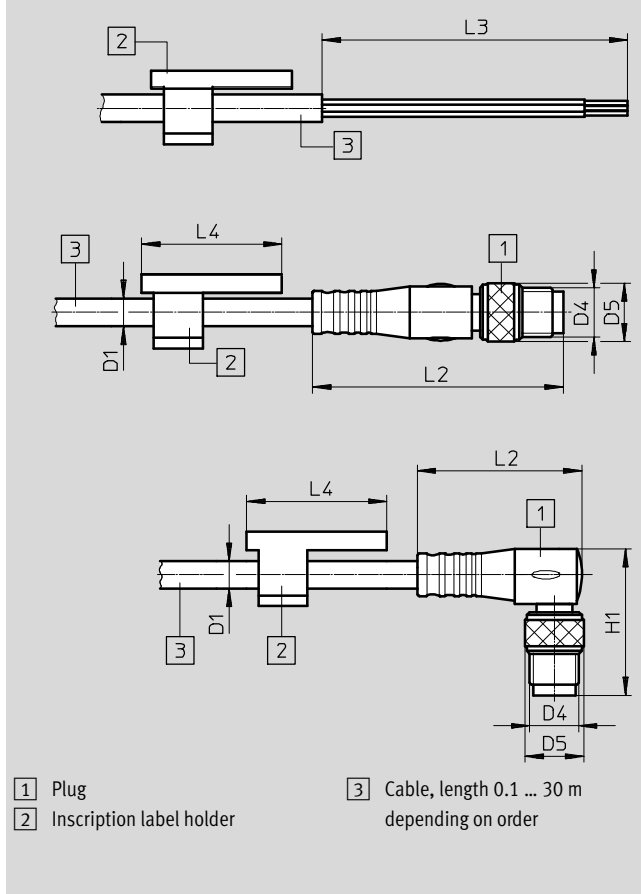

Connection technology, left	D1	D2	D3	L2	L4	H1
NEBU						
Straight socket	4.5	M12x1	15	47.5	23	-
Angled socket	4.5	M12x1	15	37.5	23	26
NEBU with display						
Angled socket	4.5	M12x1	15	37.5	23	26
NEBU-M12G5-...-Q8N-M12G5						
Straight socket	7	M12x1	15	47.5	-	-
SIM						
Straight socket	4.5	M12x1	15	48.5	-	-
Angled socket	4.5	M12x1	-	37.5	-	26

Connection technology, right	D1	D4	D5	L2	L3	L4	H1
NEBU							
Open end	4.5	-	-	-	50	23	-
Straight plug	4.5	M8x1	9.6	41.1	-	23	-
	4.5	M12x1	15	54.5	-	23	-
Angled plug	4.5	M8x1	9.6	26.9	-	23	24
	4.5	M12x1	15	37.5	-	23	33.2
NEBU with display							
Open end	4.5	-	-	-	50	23	-
Straight plug	4.5	M8x1	9	41.1	-	23	-
	4.5	M12x1	15	54.5	-	23	-
Angled plug	4.5	M8x1	9	26.9	-	23	24
	4.5	M12x1	15	37.5	-	23	33.2
NEBU-M12G5-...-Q8N-M12G5							
Straight plug	7	M12x1	15	54.5	-	-	-
SIM							
Open end	4.5	-	-	-	50	-	-

Connecting cables, M12 5-pin

Technical data

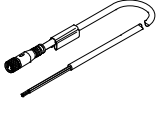
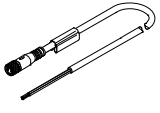
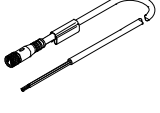
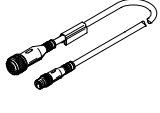
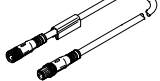
Ordering data						
	Cable length [m]	Cable properties	Outlet orientation	Special features	Part No.	Type
Socket, 5-pin, M12 – open cable end, 3-wire						
	2.5	Standard	Straight	–	541363	NEBU-M12G5-K-2.5-LE3
				Switching status display for PNP N/O contact	541366	NEBU-M12W5P-K-2.5-LE3
	5	Standard	Angled	–	541367	NEBU-M12W5-K-2.5-LE3
				Switching status display for NPN N/O contact	541365	NEBU-M12W5N-K-2.5-LE3
	5	Standard	Straight	–	541364	NEBU-M12G5-K-5-LE3
				–	541370	NEBU-M12W5-K-5-LE3
5	Standard	Angled	Switching status display for NPN N/O contact	541368	NEBU-M12W5N-K-5-LE3	
			Switching status display for PNP N/O contact	541369	NEBU-M12W5P-K-5-LE3	
Socket, 5-pin, M12 – open cable end, 4-wire						
	2.5	Standard	Straight	–	550326	NEBU-M12G5-K-2.5-LE4
				–	550325	NEBU-M12W5-K-2.5-LE4
	5	Standard	Straight	–	541328	NEBU-M12G5-K-5-LE4
				–	164259	SIM-M12-4GD-5-PU
	5	Standard	Angled	–	541329	NEBU-M12W5-K-5-LE4
				–	164258	SIM-M12-4WD-5-PU
7	Standard	Straight	–	8003134	NEBU-M12G5-K-7-LE4	
10	Standard	Angled	–	569841	NEBU-M12W5-K-10-LE4	
Socket, 5-pin, M12 – open cable end, 5-wire						
	2.5	Standard	Straight	–	541330	NEBU-M12G5-K-2.5-LE5
				–	175715	SIM-M12-5GD-2,5-PU
	5	Standard	Angled	–	567843	NEBU-M12W5-K-2.5-LE5
				–	541331	NEBU-M12G5-K-5-LE5
	5	Standard	Straight	–	175716	SIM-M12-5GD-5-PU
				–	567844	NEBU-M12W5-K-5-LE5
10	Standard	Straight	–	554038	NEBU-M12G5-K-10-LE5	
Socket, 5-pin, M12 – plug, 4-pin, M8						
	2.5	Standard	Straight - straight	–	554036	NEBU-M12G5-K-2.5-M8G4
		Suitable for use with energy chains	Straight - straight	Cable, 2-wire, halogen-free and oil-resistant	554034	NEBU-M12G5-E-2.5-W2-M8G4-V1
			Straight - straight	Cable, 3-wire, halogen-free and oil-resistant	554033	NEBU-M12G5-E-2.5-W3-M8G4-V2
Socket, 5-pin, M12 – plug, 4-pin, M12						
	0.5	Standard	Straight - straight	–	8000208	NEBU-M12G5-K-0.5-M12G4

Connecting cables, M12 5-pin

Technical data



Ordering data						
Socket, 5-pin, M12 – plug, 5-pin, M12						
	0.5	Standard	Straight - angled	–	8003617	NEBU-M12G5-K-0.5-M12W5
			Angled - angled	–	570733	NEBU-M12W5-K-0.5-M12W5
	2	Standard	Straight - angled	–	8003618	NEBU-M12G5-K-2-M12W5
			Angled - angled	–	570734	NEBU-M12W5-K-2-M12W5
	5	Suitable for use with energy chains	Straight - straight	Nominal conductor cross section 1 mm ² , oil-resistant	574321	NEBU-M12G5-E-5-Q8N-M12G5
	7.5	Suitable for use with energy chains	Straight - straight	Nominal conductor cross section 1 mm ² , oil-resistant	574322	NEBU-M12G5-E-7.5-Q8N-M12G5
	10	Suitable for use with energy chains	Straight - straight	Nominal conductor cross section 1 mm ² , oil-resistant	574323	NEBU-M12G5-E-10-Q8N-M12G5

Connecting cables, M12 8-pin

Technical data

Plug socket with cable

NEBU-M12

SIM-M12-8

KM12-8

- Pre-assembled at both ends
- Cable lengths: 2 m, 5 m, 10 m and 15 m
- 8 wires
- M12



General technical data				
Conforms to standard	NEBU/SIM			EN 61076-2-101
Cable composition	NEBU/SIM		[mm ²]	8 x 0.25, screened
	KM12		[mm ²]	8 x 0.25
Cable diameter	NEBU/SIM		[mm]	6.3
	KM12		[mm]	6.2
Wire ends	NEBU/SIM			Tin-plated
Type of mounting	NEBU/SIM			Via union nut
	KM12			Via union nut, via threaded connector
Cable property	NEBU/SIM			Standard
Cable identification	NEBU/SIM			Without inscription label holder
Cable bending radius	NEBU/SIM	Fixed cable installation	[mm]	Minimum 66
		Flexible cable installation	[mm]	Minimum 32

Technical data				
Operating voltage range			[V DC]	0 ... 30
			[V AC]	0 ... 30
Current-carrying capacity	At 40 °C		[A]	2
Surge resistance	NEBU/SIM		[kV]	0.8
Degree of protection	NEBU/SIM			IP67, to IEC 60529, in assembled state
	KM12			IP68, to IEC 60529, in assembled state

Materials				
Cable sheath colour	NEBU/SIM			Grey
Housing	NEBU/SIM			TPE-U (PUR)
Insulating sheath	NEBU			PP
Union nut	NEBU/SIM			Nickel-plated brass
Cable sheath	NEBU/SIM			TPE-U (PUR)
	KM12			PUR
Pin contacts	NEBU			Gold-plated brass
	SIM/KM12			Nickel-plated and gold-plated bronze
Note on materials	NEBU/SIM			RoHS compliant
	KM12			-

Operating and environmental conditions				
Ambient temperature	NEBU		[°C]	-35 ... +85
		With flexible cable installation	[°C]	-25 ... +85
	SIM		[°C]	-25 ... +85
		KM12		[°C]
Degree of contamination	NEBU/SIM			3

Connecting cables, M12 8-pin

Technical data

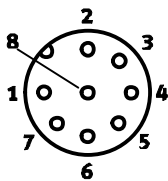
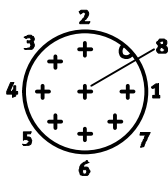
Wiring allocation (socket view)					
Socket	Pin	Wire colour ¹⁾	Pin	Plug	
Electrical connection, socket, 8-pin, M12 – open cable end					
	1	WH	-	-	
	2	BN	-		
	3	GN	-		
	4	YE	-		
	5	GY	-		
	6	PK	-		
	7	BU	-		
	8	RD	-		
Electrical connection, socket, 8-pin, M12 – plug, 8-pin					
	1	WH	1		
	2	BN	2		
	3	GN	3		
	4	YE	4		
	5	GY	5		
	6	PK	6		
	7	BU	7		
	8	RD	8		

1) To IEC 757

Dimensions

Connection technology, left

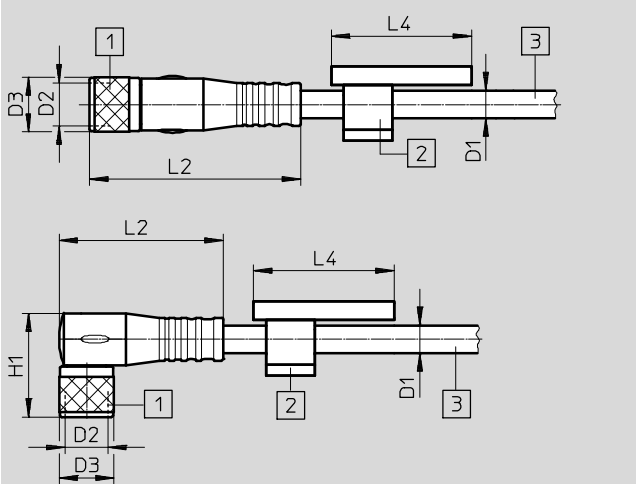

1 Socket M12x1
2 Inscription label holder, must be ordered separately as an accessory
3 Cable, length 2 m, 5 m, 10 m, 15 m depending on order

Download CAD data → www.festo.com

Connection technology, right

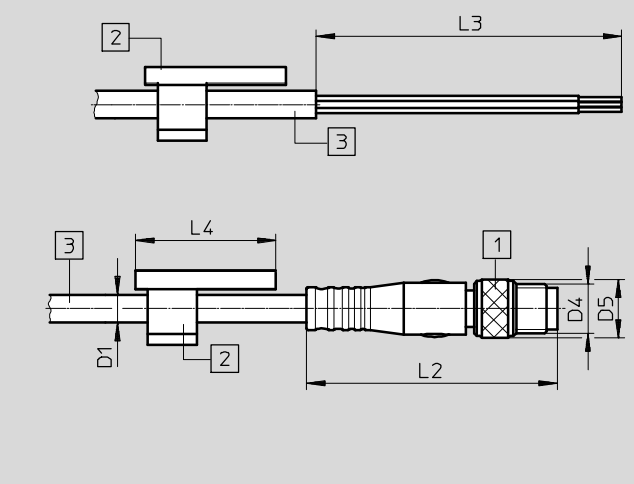

1 Plug
2 Inscription label holder, must be ordered separately as an accessory
3 Cable, length 2 m, 5 m, 10 m, 15 m depending on order

Connection technology, left	D1	D2	D3	L2	L4	H1
NEBU						
Angled socket	6.3	M12x1	14.5	38	-	28
SIM						
Straight socket	6.3	M12x1	14.6	-	-	-
KM12						
Straight socket	6.2	M12x1	-	-	-	-

Connection technology, right	D1	D4	D5	L2	L3	L4
NEBU						
Open end	6.3	-	-	-	50	-
SIM						
Open end	6.3	-	-	-	50	-
KM12						
Straight plug	6.2	M12x1	14.6	-	-	-

Connecting cables, M12 8-pin

Technical data

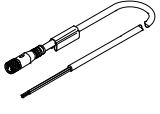
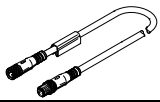
Ordering data							
	Cable length [m]	Cable property	Outlet direction	Special features	Product weight [g]	Part No.	Type
Socket, 8-pin, M12 – open cable end, 8-wire							
	2	Standard	Angled	–	–	542256	NEBU-M12W8-K-2-N-LE8
			Straight	–	–	525616	SIM-M12-8GD-2-PU
	5	Standard	Angled	–	–	542257	NEBU-M12W8-K-5-N-LE8
			Straight	–	343	525618	SIM-M12-8GD-5-PU
	10	Standard	Angled	–	–	570007	NEBU-M12W8-K-10-N-LE8
			Straight	–	–	570008	SIM-M12-8GD-10-PU
15	Standard	Angled	–	–	8048086	NEBU-M12W8-K-15-N-LE8	
Socket, 8-pin, M12 plug, 8-pin, M12							
	2	Standard	Straight - straight	–	156	525617	KM12-8GD8GS-2-PU

Connecting cables, 7/8", 5-pin

Technical data

Connecting cable
NEBU-G78W5

- Connecting cable for power supply
- Pre-assembled
- Cable length 2 m
- 5 wires
- 7/8"



General technical data			
Electrical connection		Angled socket/open end	
		7/8" round plug connector	
		5-pin	
Plug coding		NFPA/T3.5.29 R1-2003	
Based on standard		EN 61984	
Cable composition	[mm ²]	5x 1.5	
Cable diameter	[mm]	8.7	
Cable diameter tolerance	[mm]	±2	
Cable characteristics		Standard	
Min. cable bending radius	[mm]	65	
Operating voltage range	[V]	0 ... 300 DC	0 ... 300 AC
Surge resistance	[kV]	4	
Acceptable current load at 40 °C	[A]	9	
Protection class to EN 60529		IP65, IP67	
Product weight	[g]	300	

Materials	
Housing	TPE-U(PU)
Union nut	Nickel-plated brass
Pin contact	Gold-plated brass
Cable sheath	PUR
Cable characteristics	For static applications
Note on materials	RoHS-compliant

Operating and environmental conditions		
Ambient temperature	[°C]	-20 ... +80
CE marking (see declaration of conformity)		In accordance with EU Low Voltage Directive
Degree of contamination		3

Connecting cables, 7/8", 5-pin

Technical data

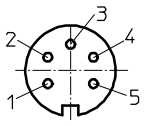
Circuitry (socket view)				
Socket	Pin	Wire colour ¹⁾	Pin	Plug
Electrical connection: socket, 5-pin, 7/8" – open cable end				
	1	SW	-	-
	2	BU	-	
	3	GN/YE	-	
	4	BN	-	
	5	WH	-	

1) To IEC 757

Dimensions

Connection technology, left-hand end

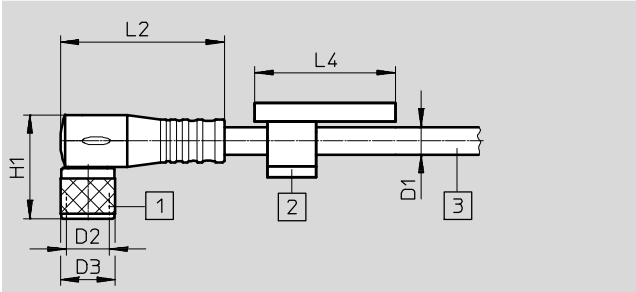

1 Socket 7/8" 3 Cable, length 2 m
2 Inscription label holder

Download CAD data → www.festo.com

Connection technology, right-hand end

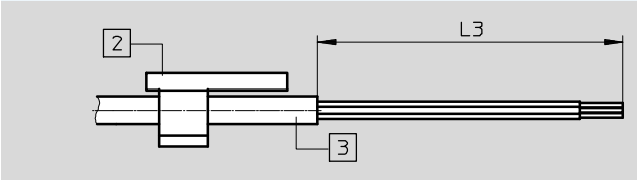

2 Inscription label holder 3 Cable, length 2 m

Connection technology, left-hand end	D1	D2	D3	L2	L4	H1
Angled socket	8.7	7/8"	26	53	-	40.4

Connection technology, right-hand end	D1	D4	D5	L2	L3	L4	H1
Open end	4.5	-	-	-	-	-	-

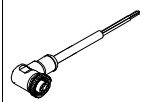
Ordering data						
	Cable length [m]	Cable characteristics	Outlet direction	Special features	Part No.	Type
Socket, 5-pin, 7/8" – open cable end						
	2	Standard	Angled	-	573855	NEBU-G78W5-K-2-N-LE5

Connecting cables, clip, 3-pin

Technical data

Connecting cable
SIM-K

- Plug socket with cable for connecting inputs/outputs
- Pre-assembled
- Cable lengths 2.5 m, 5 m and 10 m
- 3 wires
- Mounting via clip



General technical data	
Conforms to standard	EN 61076-2-104 EN 61984
Cable diameter [mm]	4.5
Nominal conductor cross section [mm ²]	0.25
Cable characteristics	Standard
Cable test conditions	Resistance to bending: to Festo standard Test conditions on request Energy chain: 5 million cycles, bending radius 75 mm

Technical data	
Operating voltage range [V]	0 ... 60 DC
Acceptable current load [A]	3
Surge resistance [kV]	1.5
Protection class to EN 60529	IP65, IP67

Materials	
Wire colour	Blue, brown, black
Housing colour	Black
Cable sheath colour	Grey
Housing	TPE-U(PU)
Insulating sheath	PVC
Cable sheath	TPE-U(PU)
Note on materials	RoHS-compliant

Operating and environmental conditions	
Ambient temperature [°C]	-25 ... +70
Ambient temperature with flexible cable installation [°C]	-5 ... +70
CE marking (see declaration of conformity)	In accordance with EU Low Voltage Directive
Degree of contamination	3

Connecting cables, clip, 3-pin

Technical data

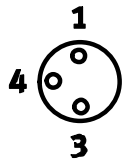
Circuitry (socket view)					
Socket	Pin	Wire colour ¹⁾	Pin	Plug	
Electrical connection: socket, 3-pin, clip – open cable end					
	1	BN	-	-	
	3	BU	-		
	4	BK	-		

1) To IEC 757

Dimensions Download CAD data → www.festo.com

Connection technology, left-hand end

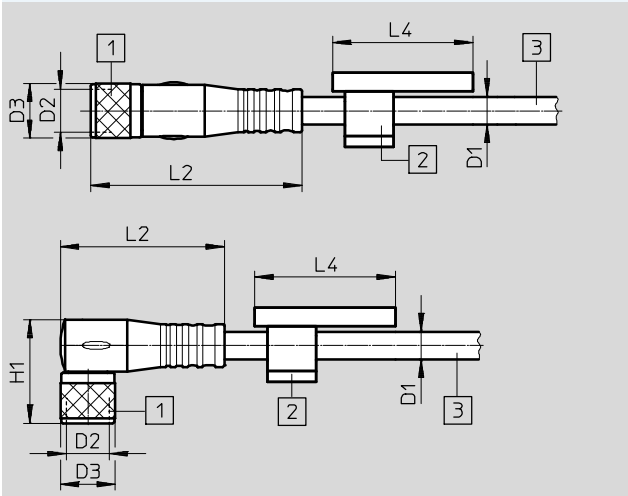

1 Socket
2 Inscription label holder
3 Cable, length 2.5 m, 5 m, 10 m depending on order

Connection technology, right-hand end

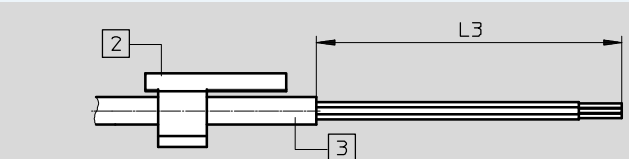

2 Inscription label holder
3 Cable, length 2.5 m, 5 m, 10 m depending on order

Connection technology, left-hand end	D1 ∅	D2	D3 ∅	L2	L4	H1
Straight socket	4.5	-	8.5	33.6	-	-
Angled socket	4.5	8.3	8.5	26.1	-	18.4

Connection technology, right-hand end	D1 ∅	L3	L4	H1
Open end	4.5	50	-	-

Ordering data

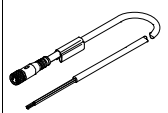
	Cable length [m]	Cable characteristics	Outlet direction	Special features	Part No.	Type
Socket, 3-pin, clip – open cable end						
	2.5	Standard	Straight	-	164257	SIM-K-GD-2,5-PU
			Angled	-	164255	SIM-K-WD-2,5-PU
	5	Standard	Straight	-	164256	SIM-K-GD-5-PU
			Angled	-	164254	SIM-K-WD-5-PU
	10	Standard	Straight	-	192962	SIM-K-GD-10-PU
			Angled	-	192963	SIM-K-WD-10-PU

Connecting cables, clip, 4-pin

Technical data

Connecting cable
SIM-K

- Plug socket with cable for connecting inputs/outputs
- Pre-assembled
- Cable lengths 2.5 m and 5 m
- 4 wires
- Mounting via clip



General technical data	
Conforms to standard	EN 61076-2-104 EN 61984
Cable diameter [mm]	4.5
Nominal conductor cross section [mm ²]	0.25
Cable characteristics	Standard
Cable test conditions	Resistance to bending: to Festo standard Test conditions on request Energy chain: 5 million cycles, bending radius 75 mm

Technical data	
Operating voltage range [V]	0 ... 30 DC
Acceptable current load [A]	3
Surge resistance [kV]	0.8
Protection class to EN 60529	IP65, IP67

Materials	
Wire colour	Blue, brown, black, white
Housing colour	Black
Cable sheath colour	Grey
Housing	TPE-U(PU)
Insulating sheath	PVC
Cable sheath	TPE-U(PU)
Note on materials	RoHS-compliant

Operating and environmental conditions	
Ambient temperature [°C]	-25 ... +70
Ambient temperature with flexible cable installation [°C]	-5 ... +70
Degree of contamination	3

Connecting cables NEBU, universal

Ordering data – Modular products



Ordering table		Conditions	Code	Enter code
M	Module No.			
	Function		NEBU	NEBU
	Connection technology, left-hand end	Open end	1	-LE
		Socket with connecting thread M8		-M8
		Socket with connecting thread M12, A-coded		-M12
M	Socket design	None (only with open end connection technology at left-hand end)		
		Straight		G
		Angled		W
		Rotatable	2	R
M	Number of pins/wires (left-hand end)	3-pin (suitable for open end, plug M8)		3
		4-pin (suitable for open end, plug M8)		4
		5-pin (suitable for 3, 4 and 5-pin plug M12)		5
O	Display	Without LED, DC (standard)		
		LED, PNP	3	P
		LED, NPN	3	N
		LED, DC	4	L
		2x LED, PNP	5	P2
M	Cable characteristics	Basic		-P
		Standard		-K
		Suitable for use with energy chains		-E
		Suitable for robot applications		-R
	Cable length	0.1 ... 30 m (0.1 ... 2.5 m in 0.1 m increments, 2.5 ... 30 m in 0.5 m increments)		-...
O	Wire cross section	0.25 mm ² (standard)		
		1.00 mm ²	6	Q8
	Cable colour	Grey (standard)		
	Cable designation	With inscription label holder (standard)		
		Without inscription label holder		-N
M	Connection technology, right-hand end	Open end (not possible with open end connection technology at left-hand end)	1	-LE
		Plug with connecting thread M8		-M8
		Plug with connecting thread M12, A-coded		-M12
M	Plug design	None (only with open end connection technology at right-hand end)		
		Straight		G
		Angled		W
M	Number of pins/wires (right-hand end)	2-pin	7	2
		3-pin (suitable for socket M8/M12)	8	3
		4-pin (suitable for socket M8/M12)	8	4
		5-pin (suitable for socket M12)	8 9	5

- | | |
|--|--|
| <p>1 LE With open end LE, the number of pins/wires at the open end must be equal or less than the number of pins on the opposite side.</p> <p>2 R Can only be combined with M8 (connection technology at left-hand end), 3-pin (pins/wires at left-hand end), without display, standard wire cross section.</p> <p>3 P, N Can only be combined with M8 connection technology at left-hand end in combination with socket design W and 3 pins/wires (left-hand end) or M12 connection technology at left-hand end in combination with socket design W and 5 pins/wires (left-hand end) and 3 pins/wires (right-hand end).</p> <p>4 L Can only be combined with M8 connection technology at left-hand end with 4 pins/wires (left-hand end) and M8 connection technology at right-hand end with 3 or 4 pins/wires (left-hand end) or M12 connection technology at right-hand end with 2 pins/wires (left-hand end) or LE connection technology at right-hand end with 2 pins/wires (left-hand end). Can only be combined with cable characteristics K.</p> | <p>5 P2 Can only be combined with M12 connection technology at left-hand end in combination with socket design W and 4 pins/wires (right-hand end).</p> <p>6 Q8 Can only be combined with M12 connection technology at left-hand end in combination with socket design G and 5 pins/wires (left-hand end) and M12 connection technology at right-hand end in combination with plug design G and 5 pins/wires (left-hand end). Can only be combined with cable characteristics E.</p> <p>7 2 Can only be combined with M12 connection technology at right-hand end or LE in combination with display L.</p> <p>8 3, 4, 5 Can only be combined with cable characteristics K.</p> <p>9 5 With LE connection technology at left-hand end, the number of wires (left-hand end) is copied over. Can only be combined with M12 or LE connection technology at left-hand end.</p> |
|--|--|

Transfer order code

539052 NEBU - - - - - - - - - -