

Approval Sheet

for

**Cement Resistors
Power Wirewound & Axial / Vertical
Lead Type**

PSP & PSM series

$\pm 5\%$ & $\pm 10\%$

YAGEO CORPORATION

Headquarters: 3F, No.233-1, Pao Chiao Rd., Xindian, Taipei, Taiwan, R.O.C.

Tel: 886-2-6629-9999 **Fax:** 886-2-6628-8885

URL: www.yageo.com

**1. PRODUCT:**

1. Power Wirewound Resistors. Fiber Glass Core and with Ceramic Case. Wirewound construction, Insulated and Flameproof (PSP & PSM SERIES)

2. PART NUMBER:

Part number of the cement resistor is identified by the name, power, tolerance, packing, temperature coefficient and resistance value.

Example :

PSP	400	J	B	-	100R
(1)	(2)	(3)	(4)	(5)	(6)
Series Name	Power Rating	Resistance Tolerance	Packing Style	Temperature Coefficient of Resistance	Resistance Value

(1) Style : PSP SERIES: Axial Type
PSM SERIES: Vertical Type

(2) Power Rating : 400=4W 、 500=5W 、 7WS=7W 、 700=7W 、 900=9W 、 11A=11W 、 17A=17W

(3) Tolerance : J = $\pm 5\%$ 、 K = $\pm 10\%$

(4) Packaging Type : B = Bulk Packing
R = Taped in reel

(5) Temperature Coefficient : $\pm 400\text{ppm}/^\circ\text{C}$

(6) Resistance Value : E24 Series

Example : 0R1, 1R 、 10R 、 100R 、 10K.....



3. ELECTRICAL CHARACTERISTICS

STYLE	PSP400	PSP500	PSP7WS	PSP700	PSP900	PSP11A	PSP17A
Power Rating at 70 °C	4W	5W	7W		9W	11W	17W
Max. Cont. Work. Voltage	$\sqrt{P_{70} \times R}$						
Resistance range	0.1~2.2KΩ		0.1~2.5KΩ	0.5~3.9KΩ		1~10KΩ	
Operating Temp. Range	- 55 °C to + 275 °C						
Temperature Coefficient	±400ppm/°C						

STYLE	PSM400	PSM500	PSM7WS	PSM700	PSM900	PSM11A	PSM17W
Power Rating at 70 °C	4W	5W	7W		9W	11W	17W
Max. Cont. Work. Voltage	$\sqrt{P_{70} \times R}$						
Resistance range	0.1~2.2KΩ		0.1~2.5KΩ	0.5~3K9Ω		1~10KΩ	
Operating Temp. Range	- 55 °C to + 275 °C						
Temperature Coefficient	±400ppm/°C						

* Below or over this resistance range on request

4. DERATING CURVE

For resistors operated in ambient temperatures above 70°C, power rating must be derated in accordance with the curve below.

Rated Load (%)

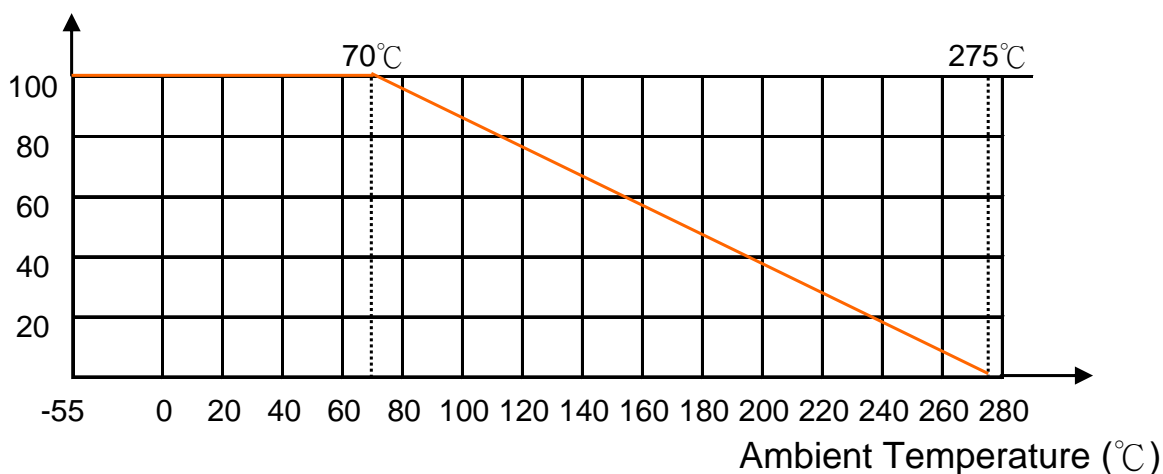

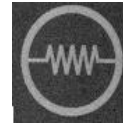

5. DIMENSIONS

PSP Series

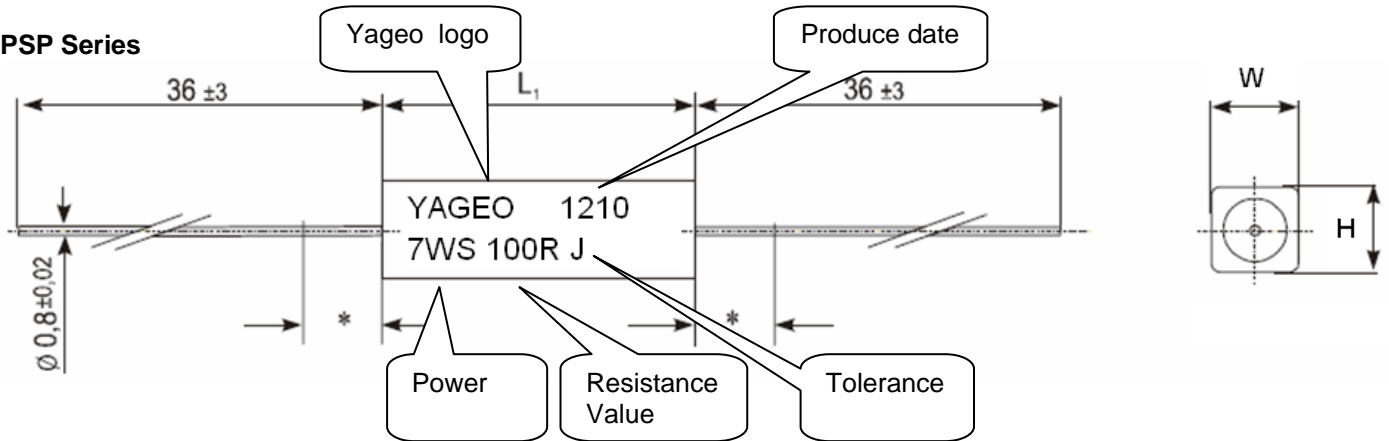

PSM Series

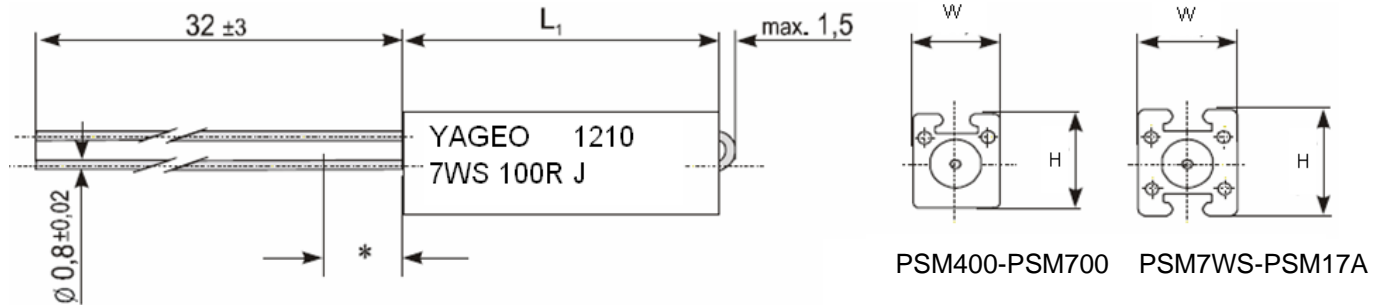

Unit : mm

TYPE	L1	W	H
PSP400	20±1.0	6.4 ± 0.3	6.4 ± 0.3
PSP500	25±1.0	6.4 ± 0.3	6.4 ± 0.3
PSP700	38±1.0	6.4 ± 0.3	6.4 ± 0.3
PSP7WS	25±1.0	9.0 ± 0.3	9.0 ± 0.3
PSP900	38±1.0	9.0 ± 0.3	9.0 ± 0.3
PSP11A	50±1.5	9.0 ± 0.3	9.0 ± 0.3
PSP17A	75±2.0	9.0 ± 0.3	9.0 ± 0.3

TYPE	L1	W	H
PSM400	20±1.0	7.0 ± 0.5	8.0 ± 0.4
PSM500	25±1.0	7.0 ± 0.5	8.0 ± 0.4
PSM700	38±1.0	7.0 ± 0.5	8.0 ± 0.4
PSM7WS	25±1.0	9.0 ± 0.4	10.0 ± 0.4
PSM900	38±1.0	9.0 ± 0.4	10.0 ± 0.4
PSM11A	50±1.5	9.0 ± 0.4	10.0 ± 0.4
PSM17A	75±2.0	9.0 ± 0.4	10.0 ± 0.4

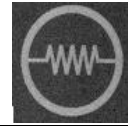

6. ENVIRONMENTAL CHARACTERISTICS

(1) Short Time Over Load Test

At 2.5 times of the rated voltage applied for 5 seconds, the resistor should be free from defects after the resistor is released from load for about 30 minutes

$$\text{Short Time Overload Voltage} = 2.5 * \sqrt{\text{Power Rating} \times \text{Resistance Value}}$$

The change of the resistance value should be within $\pm 2.0 \% + 0.05\Omega$

(2) Voltage Proof

The resistor shall be clamped in the trough of a 90° metal V Block. Apply the insulation voltage of 1000V between the terminals connected together with the block for about 60 seconds.
The resistor shall be able to withstand without breakdown or flashover.

(3) Temperature Coefficient Test

Test of resistors above room temperature $100^{\circ}\text{C} \pm 2^{\circ}\text{C}$ (Testing Temperature 115°C to 130°C) at the constant temperature silicon plate for over 5 minutes. Then measure the resistance value.
The Temperature Coefficient is calculated by the following equation and its value should be within the range of requested.

$$\text{Resistor Temperature Coefficient} = \frac{R - R_0}{R_0} \times \frac{1}{t - t_0} \times 10^6$$

R = Resistance value under the testing temperature

R₀ = Resistance value at the room temperature

t = The testing temperature

t₀ = Room temperature

(4) Insulation Resistance

Apply "measuring voltage" between protective coating and termination for 1 min., then measure. The measuring voltage shall be either 100V±15V d.c. for resistors with an insulation voltage lower than 500V or 500V±50V d.c. for resistors with an insulation voltage equal to or greater than 500V.
The test resistance should be high than 1,000M ohm.

(5) Solderability

Immerse the specimen into the solder pot at $235 \pm 5^{\circ}\text{C}$ for 3 ± 0.5 seconds.
At least 90% solder coverage on the termination.

(6) Solvent Resistance of Marking

The specimen into the appropriate solvent of IPA condition of ultrasonic machine for 5 ± 0.5 minutes.
The specimen is no deterioration of coatings and color code.

(7) Robustness of Terminations

Direct Load – Resistors shall be held by one terminal and the load shall be gradually applied in the direction of the longitudinal axis of the resistor unit the applied load reached the requirement.

The load shall be held for 10 seconds. The load of weight shall be ≥ 2.5 kg (24.5N).

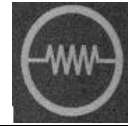

(8) Periodic-pulse Overload

Apply 4 times of rated voltage to the specimen at the 1 second on and 25 seconds off cycle, subjected to voltage application cycles specified in 10,000 time ◦

The change of the resistance value shall be within $\pm 2.0\% + 0.05 \Omega$

(9) Damp Heat Steady State

Place the specimen in a test chamber at 40 °C and 93 % relative humidity. Apply the rated voltage to the specimen at the 1.5 hours on and 0.5 hour off cycle. The total length of test is 1,000 hours

The change of the resistance value shall be within $\pm 5.0 \% + 0.05 \Omega$

(10) Endurance at 70 °C

Placed in the constant temperature chamber of $70 \pm 3 \text{ }^\circ\text{C}$ the resistor shall be connected to the lead wire at the point of 25mm. Length with each terminal, the resistors shall be arranged not much effected mutually by the temperature of the resistors and the excessive ventilation shall not be performed, for 90 minutes on and 30 minutes off under this condition the rated D.C. voltage is applied continuously for 1000+48/-0 hours then left at no-load for 1hour, measured at this time the resistance value ◦

The change of the resistance value shall be within $\pm 5.0 \% + 0.05 \Omega$.

There shall be no remarkable change in the appearance and the color code shall be legible after the test.

(11) Temperature Cycling Test

The temperature cycle shown in the following table shall be repeated 5 times consecutively. The measurement of the resistance value is done before the first cycle and after ending the fifth cycle, leaving in the room temperature for about 1 hour ◦

Temperature Cycling Conditions:

Step	Temperature(°C)	Time (minute)
1	-55 ± 3	30
2	25 ± 3	10 ~ 15
3	155 ± 3	30
4	25 ± 3	10 ~ 15

The change of the resistance value shall be within $\pm 2.0 \% + 0.05 \Omega$

After the test the resistor shall be free from the electrical or mechanical damage.

(12) Resistance to Soldering Heat

The terminal lead shall be dipped into the solder pot at $260 \pm 3 \text{ }^\circ\text{C}$ for 10 ± 1.0 seconds up to 2.5 ~ 3.5 mm.

The change of the resistance value shall be within $\pm 1.0 \% + 0.05 \Omega$

(13) Overload Flame Retardant

At 4 times of the rated voltage. (If the voltage exceeds the maximum load voltage, the maximum load voltage will be used as the rated voltage) applied for 1 minute

$$\text{Overload Test Voltage} = 4 * \sqrt{\text{Power Rating} \times \text{Resistance Value}}$$

The resistor shall be able to no evidence of flaming arcing

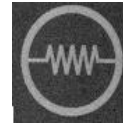

7. PACKING

Bulk

TYPE	Packing	Pieces	Pack. Code	TYPE	Packing	Pieces	Pack. Code
PSP400	Bulk	200	B	PSM400	Bulk	200	B
PSP500		200		PSM500		200	
PSP700		200		PSM700		200	
PSP7WS		200		PSM7WS		200	
PSP900		200		PSM900		200	
PSP11A		100		PSM11A		200	
PSP17A		100		PSM17A		100	

Tape/Reel

Only for PSP type

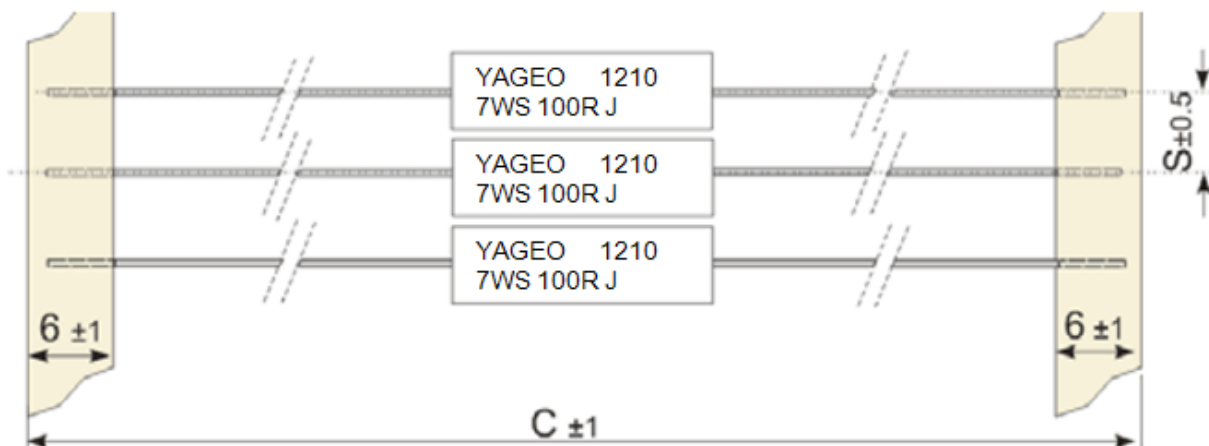

TYPE	Packing	Pieces	Pack. Code	C	S
PSP400	Taped in Reel	1000	R	95	10
PSP500		1000		95	10
PSP700		1000		95	10
PSP7WS		500		95	10
PSP900		500		95	10

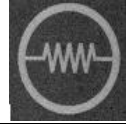

8. Plant Address

- A. China Dongguan Plant
7-1, Gaoli Road, Gaoli Industrial Zone
Tangxia Zhen, Dongguan, Guangdong, China
(廣東省東莞市塘廈鎮高麗工業區高麗路 7-1 號)
Tel. 86-769-8772 0275
Fax. 86-769-8772 0275 #4333

- B. China Suzhou Plant
No.158, Jinchang Road, No.1 Building of Nan Bang IND. Zone,
Mu Du New District, Suzhou, China
(江蘇省蘇州市木瀆新區金長路 158 號南濱工業區 1 號)
Tel. 86-512-66518889
Fax. 86-512-66519889