



FEATURES

- RoHS compliant
- Up to 2.0A I_{dc}
- 1.0μH to 470μH
- Ultra low profile
- Low R_{DC}
- Tape and reel packaging
- J-STD-020C reflow
- Backward compatible with Sn/Pb soldering systems

DESCRIPTION

The 8200 series is a range of miniature, surface-mount, I-core power inductors. They are designed for use in power applications with restricted PCB space and height, such as ExpressCard™ technology, handheld devices, DC-DC converters and notebook computers. The products are supplied in tape and reel for high-volume, automated surface-mount assembly.

SELECTION GUIDE

Order Code	Inductance, L		I _{dc} (Max.) ¹	Q Factor		SRF (Typ.) MHz	R _{dc} (Max.) Ω
	0.1V @ 10KHz	Tolerance		Q (Min.)	at frequency		
	μH	%	A				
82102C	1.0	±20%	2.0	18	1MHz	133	0.058
82152C	1.5	±20%	1.4	18	1MHz	103	0.068
82222C	2.2	±20%	1.1	18	1MHz	85	0.104
82332C	3.3	±20%	0.95	18	1MHz	67	0.138
82472C	4.7	±20%	0.80	20	1MHz	58	0.190
82682C	6.8	±20%	0.64	20	1MHz	46	0.270
82103C	10	±10%	0.50	35	1MHz	38	0.400
82153C	15	±10%	0.40	35	1MHz	31	0.560
82223C	22	±10%	0.32	35	1MHz	25	0.920
82333C	33	±10%	0.27	40	1MHz	20	1.30
82473C	47	±10%	0.25	40	1MHz	17	1.69
82683C	68	±10%	0.20	40	1MHz	15	2.55
82104C	100	±10%	0.16	40	800k	13	3.5
82154C	150	±10%	0.13	40	800k	11	5.9
82224C	220	±10%	0.10	40	800k	10	8.0
82334C	330	±10%	0.08	40	800k	9	13.5
82474C	470	±10%	0.07	50	800k	9	16.8

ABSOLUTE MAXIMUM RATINGS

Operating free air temperature range	-40°C to 85°C
Storage temperature range	-40°C to 125°C

SOLDERING INFORMATION²

Peak reflow temperature	260°C
Pin finish	Hot dipped tin

Specifications typical at T_a = 25°C

- 1 The maximum DC current occurs when either the inductance falls to 75% of its nominal value or when its temperature rise reaches 40°C, whichever is sooner.
- 2 For further information, please visit www.murata-ps.com/rohs



For full details go to
www.murata-ps.com/rohs

INDUCTANCE Vs CURRENT

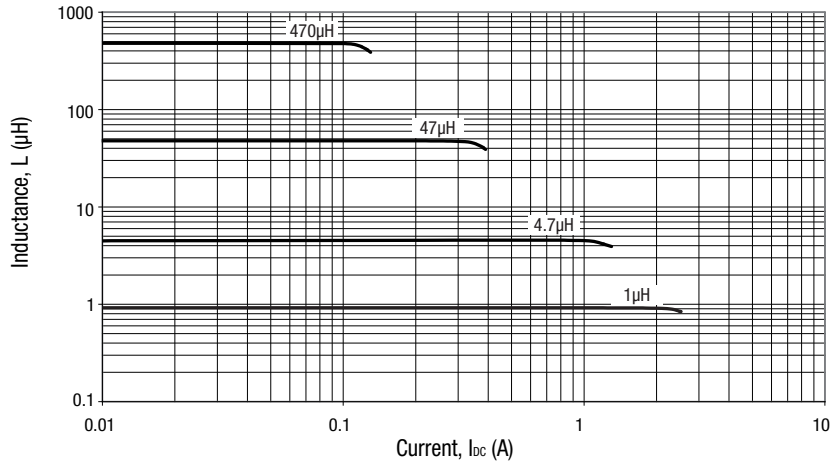

TEMPERATURE Vs CURRENT

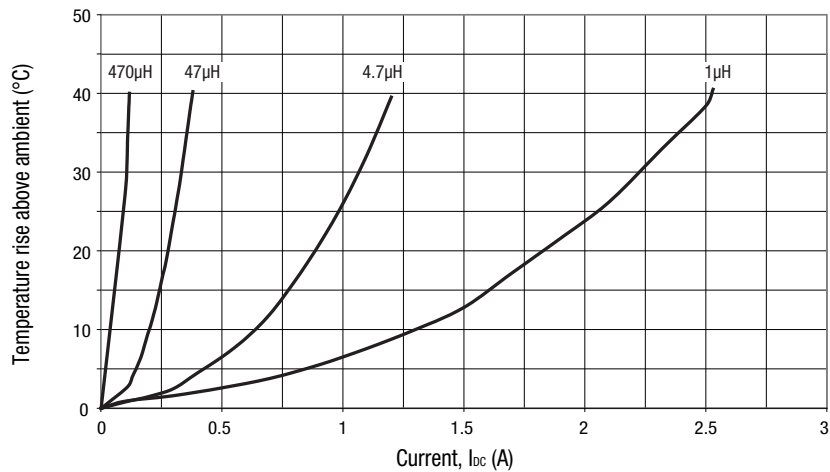

INDUCTANCE Vs FREQUENCY

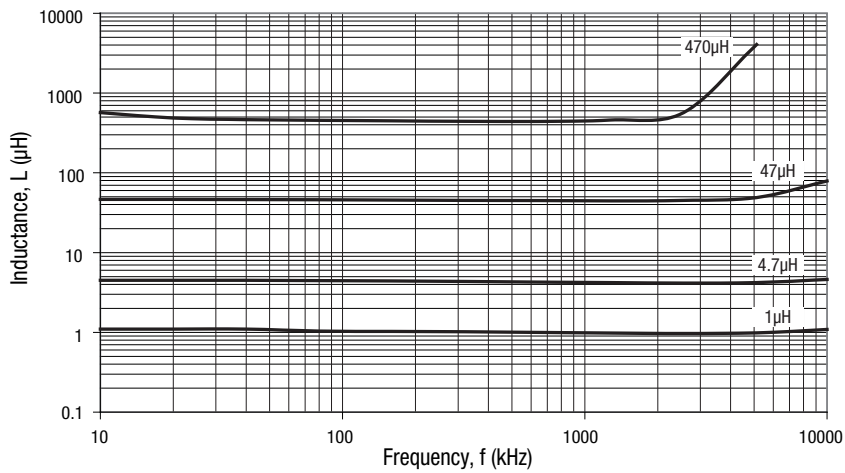

PACKAGE SPECIFICATIONS

MECHANICAL DIMENSIONS

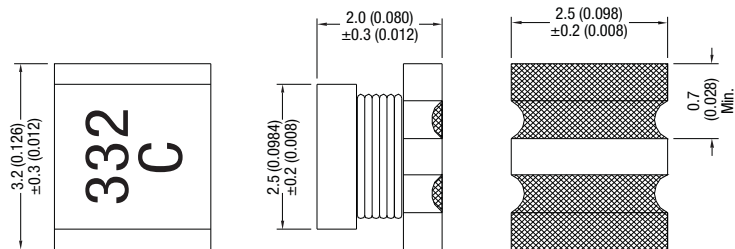

Unless otherwise stated all dimensions in mm (inches) ±0.25 (0.01).
Package Weight 0.06g Typ.

RECOMMENDED FOOTPRINT

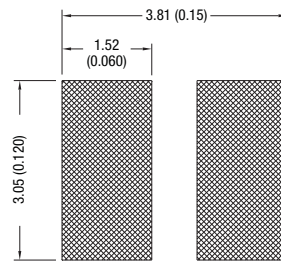

Unless otherwise stated all dimensions in mm (inches) ±0.25 (0.01).

TAPE OUTLINE DIMENSIONS

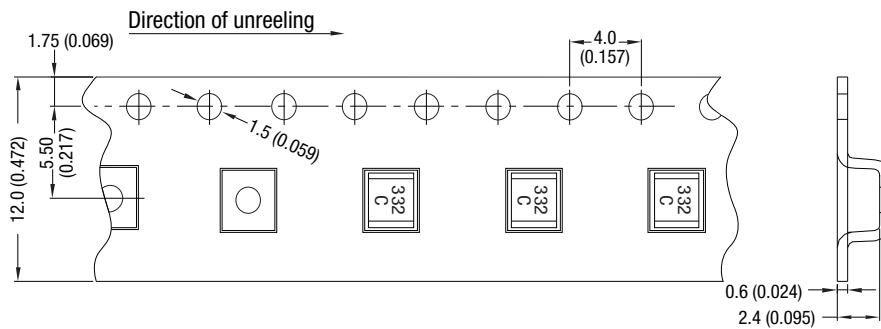

Reel Quantity: 2500
Unless otherwise stated all dimensions in mm (inches)

PACKAGE SPECIFICATIONS (continued)

REEL OUTLINE DIMENSIONS

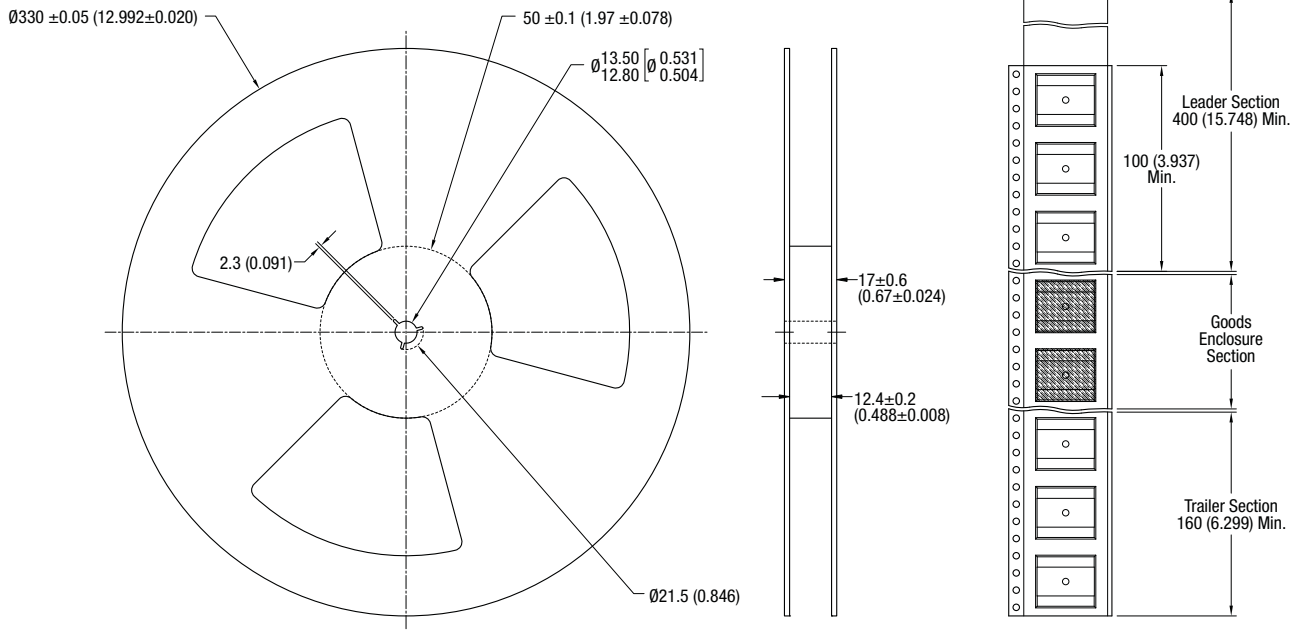

All dimension in mm [inches]
Tape and reel specifications conform with international standards EIA-481-C

Murata Power Solutions, Inc.
11 Cabot Boulevard, Mansfield, MA 02048-1151 U.S.A.
ISO 9001 and 14001 REGISTERED

Murata Power Solutions, Inc. makes no representation that the use of its products in the circuits described herein, or the use of other technical information contained herein, will not infringe upon existing or future patent rights. The descriptions contained herein do not imply the granting of licenses to make, use, or sell equipment constructed in accordance therewith. Specifications are subject to change without notice.
© 2011 Murata Power Solutions, Inc.

Mouser Electronics

Authorized Distributor

Click to View Pricing, Inventory, Delivery & Lifecycle Information:

Murata:

[82102C](#) [82103C](#) [82104C](#) [82152C](#) [82153C](#) [82154C](#) [82222C](#) [82224C](#) [82332C](#) [82333C](#) [82334C](#) [82472C](#)
[82474C](#) [82682C](#) [82683C](#) [82223C](#) [82473C](#)