

















Datasheet

RS PRO In-Line Cable Mount Connector

2338357, 2338354, 2338356, 2338355



Technical Specifications:

Number of contact	2	3	4	7	8	8B	9	10	10B	12	16	17	20	24	26	35
Male contact face view																
Rated current (A)	50	50	25	25	25	60, 5	25, 5	25	10	10	10	10	5	5	5	5
Contact diameter(mm)	∅3.5X2	∅3.5X3	∅2.5X4	∅2.5X7	∅2.5X8	∅5X2 ∅1X6	∅2.5X4 ∅1X5	∅2.5X10	∅1.5X10	∅1.5X12	∅1.5X16	∅1.5X17	∅1X20	∅1X24	∅1X26	∅1X35
Rated voltage (AC.V)	500	500	500	500	500	500 400	500	500	500	500	500	500	400	400	400	400
Test voltage(AC.V) 1 min	1500	1500	1500	1500	1500	1500	1500	1500	1500	1500	1500	1500	1200	1200	1200	1200
Contact resistance(mΩ)	0.5	0.5	1	1	1	5, 0.5	1, 5	1	2.5	2.5	2.5	2.5	5	5	5	5
Termination	solder / screw	solder / screw	solder / screw	solder / screw	solder / screw	solder	solder	solder / screw	solder	solder	solder	solder	solder	solder	solder	solder
Wire size (mm ² /AWG)	≤10/7	≤10/7	≤4/11	≤4/11	≤4/11	≤16/5 ≤0.75/18	≤4/11 ≤0.75/18	≤4/11	≤2/14	≤2/14	≤2/14	≤2/14	≤2/14	≤0.75/18	≤0.75/18	≤0.75/18
Wire size for screw termination	≤6/10	≤6/10	≤1.5/15	≤1.5/15	≤1.5/15	/	/	≤1.5/15	/	/	/	/	/	/	/	/

Product Details

The RS PRO series is a range of lightweight but robust waterproof connectors, which are sealed to IP68. Threaded coupling ensures a secure connection, even in the harshest environments. Versions are available for in-line cable to cable and for cable to panel connections. Plugs and receptacles are available with either male pins or female sockets. These products are ideal for use in outdoor applications where secure, waterproof connection is required.

Features and Benefits

- Threaded Coupling
- IP68
- 2-26 Poles
- Cable to Cable and Cable to Panel Connections



Dimensional line drawings

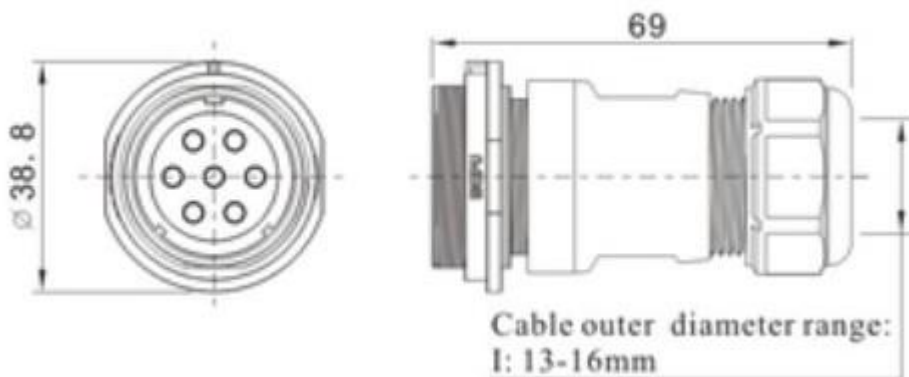

Quality Standards

