



EVM3650-QW-00A

17V, 6A, Step-Down Converter Module Evaluation Board

DESCRIPTION

The EVM3650-QW-00A is an evaluation board designed to demonstrate the capabilities of the MPM3650, a fully integrated, high-frequency, synchronous, rectified, step-down power module with an internal inductor. It offers an ultra-compact solution that achieves up to 6A of continuous output current across a wide 2.75V to 17V input voltage range, with excellent load and line regulation. Synchronous mode provides high efficiency across the output current load range.

Constant-on-time (COT) control provides very fast transient response, easy loop design, and tight output regulation. Full protection features include short-circuit protection (SCP), over-current protection (OCP), under-voltage protection (UVP), and thermal shutdown.

ELECTRICAL SPECIFICATIONS

Parameter	Symbol	Value	Units
Input voltage	V_{IN}	2.75 to 17	V
Output voltage	V_{OUT}	1	V
Output current	I_{OUT}	6	A

FEATURES

- Wide 2.75V to 17V Operating Input Range
- Continuous Output Current:
 - Up to 6A Output Current for Inputs Between 0.6V and 1.8V
 - Up to 5A Output Current for Inputs Above 1.8V
- Discontinuous Conduction Mode (DCM) for High Efficiency during Light Load Operation
- Adjustable Output from 0.6V
- Supports Pre-Biased Start-Up
- 1200kHz Fixed Switching Frequency (f_{sw})
- Configurable External Soft Start (SS)
- Enable (EN) and Power Good (PG) Pins for Power Sequencing
- Over-Current Protection (OCP) with Hiccup Mode
- Thermal Shutdown
- Available in a QFN-24 (4mmx6mmx1.6mm) Package

APPLICATIONS

- Field-Programmable Gate Array (FPGA) Power Systems
- Optical Modules
- Telecommunications
- Networking
- Industrial Equipment

All MPS parts are lead-free, halogen-free, and adhere to the RoHS directive. For MPS green status, please visit the MPS website under Quality Assurance. "MPS", the MPS logo, and "Simple, Easy Solutions" are registered trademarks of Monolithic Power Systems, Inc. or its subsidiaries.

EVM3650-QW-00A EVALUATION BOARD

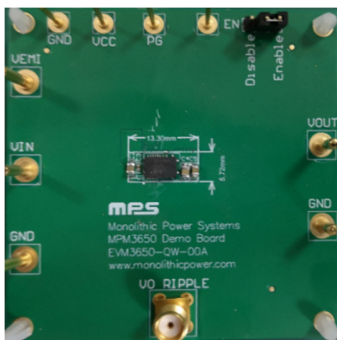

LxWxH (63.5mmx63.5mmx1.6mm)

Board Number	MPS IC Number
EVM3650-QW-00A	MPM3650GQW

Efficiency vs. Load Current vs. Power Loss

$V_{IN} = 12V$

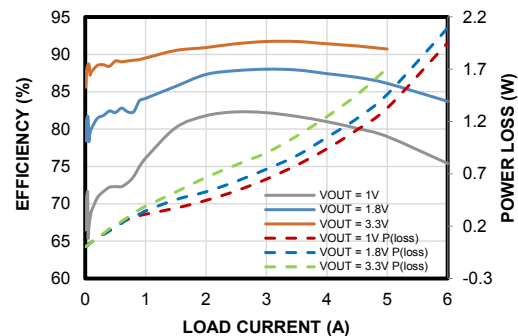

QUICK START GUIDE

1. Preset the power supply between 2.75V and 17V.
2. Turn off the power supply.
3. Connect the power supply terminals to:
 - a. Positive (+): VIN
 - b. Negative (-): GND
4. Connect load terminals ($\leq 6A$) to:
 - a. Positive (+): VOUT
 - b. Negative (-): GND
5. After making the connections, turn on the power supply. The board should start up automatically.

EVALUATION BOARD SCHEMATIC

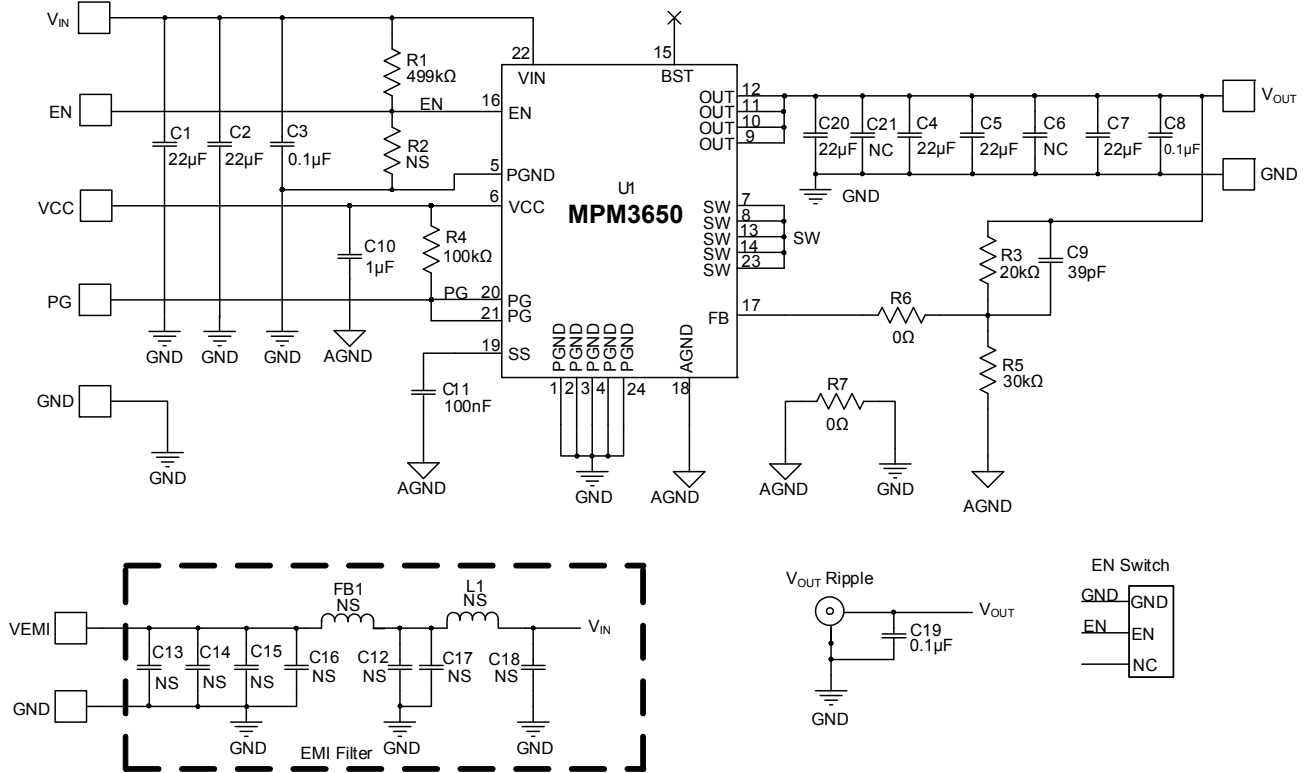

Figure 1: Evaluation Board Schematic

EVM3650-QW-00A BILL OF MATERIALS

Qty	Ref	Value	Description	Package	Manufacturer	Manufacturer PN
6	C1, C2, C4, C5, C20, C7	22 μ F	Ceramic capacitor, 25V, X5R	0805	Murata	GRM21BR61E226ME44L
4	C3, C8, C11, C19	0.1 μ F	Ceramic capacitor, 25V, X5R	0402	Würth	885012105018
1	C10	1 μ F	Ceramic capacitor, 25V, X5R	0402	Murata	GRM155R61E105KA12D
1	C9	39pF	Ceramic capacitor, 50V, C0G	0402	Murata	GRM1555C1H390JA01D
1	R1	499k Ω	Film resistor, 1%	0402	Yageo	RC0402FR-07499KL
1	R4	100k Ω	Film resistor, 1%	0402	Yageo	RC0402FR-07100KL
2	R7, R6	0 Ω	Film resistor, 1%	0402	Yageo	RC0402FR-070RL
1	R3	20k Ω	Film resistor, 1%	0402	Yageo	RC0402FR-0720KL
1	R5	30k Ω	Film resistor, 1%	0402	Yageo	RC0402FR-0730KL
1	EN	2.54mm	3-pin, single-row, straight socket header	DIP	Würth	61300311821
1	V _{OUT} ripple	NS				
5	VIN, VEMI, GND x 2, VOUT	ϕ 2mm	Copper pin	DIP	Custom	
4	EN, GND, VCC, PG	Φ 1mm	Copper pin	DIP	Custom	
1	U1	MPM3650	Step-down power module, 17V, 6A	QFN-24 (4mmx6mm)	MPS	MPM3650GQW

EVB TEST RESULTS

Performance curves and waveforms are tested on the evaluation board, $V_{IN} = 5V$, $V_{OUT} = 1V$, $T_A = 25^\circ C$, unless otherwise noted.

Thermal Derating

$V_{OUT} = 1V$

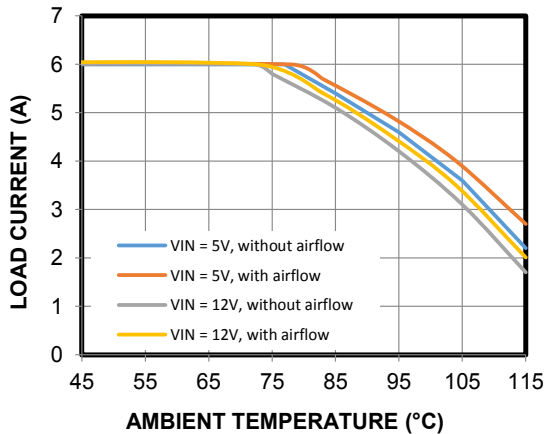

Efficiency vs. Load Current

$V_{OUT} = 1V$

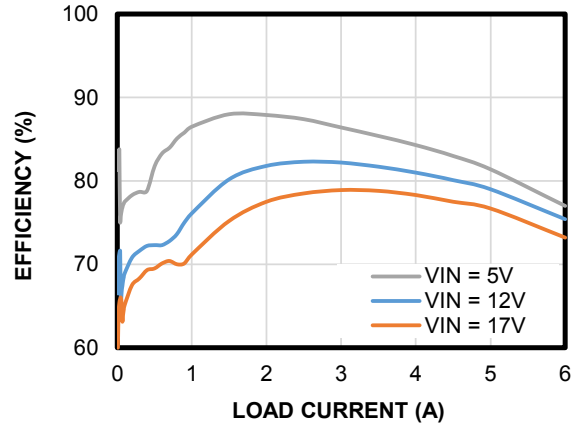

Line Regulation

$V_{OUT} = 1V$

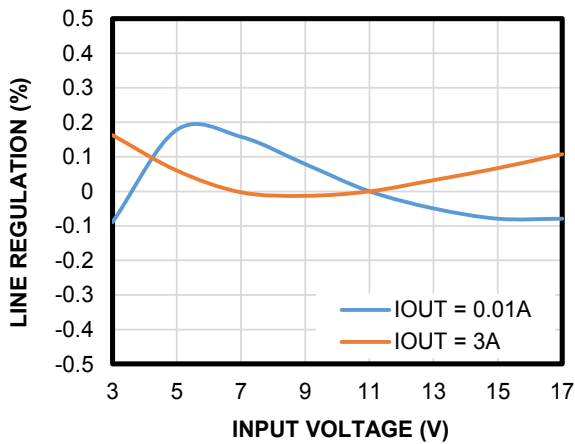

Load Regulation

$V_{OUT} = 1V$

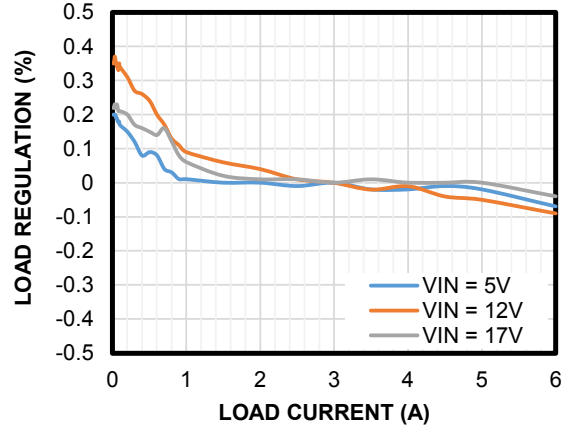

Case Temperature Rise vs. Load Current

$V_{OUT} = 1V$, $T_A = 15^\circ C$

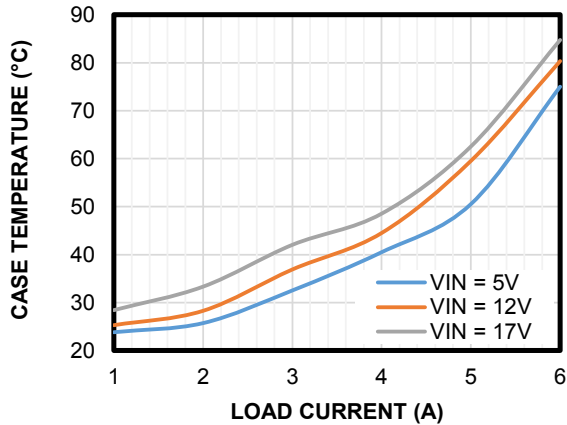

EVB TEST RESULTS (continued)

Performance curves and waveforms are tested on the evaluation board, $V_{IN} = 5V$, $V_{OUT} = 1V$, $T_A = 25^\circ C$, unless otherwise noted.

V_{OUT} Ripple

$I_{OUT} = 0A$

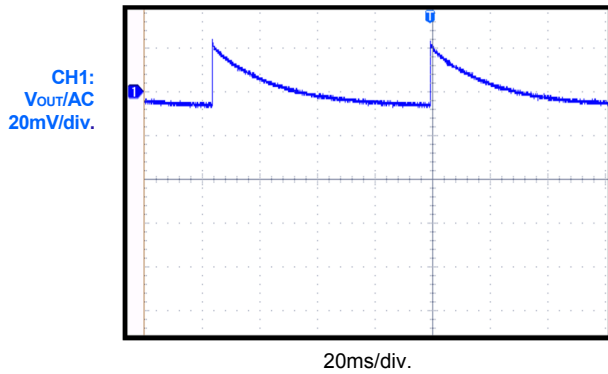

V_{OUT} Ripple

$I_{OUT} = 6A$

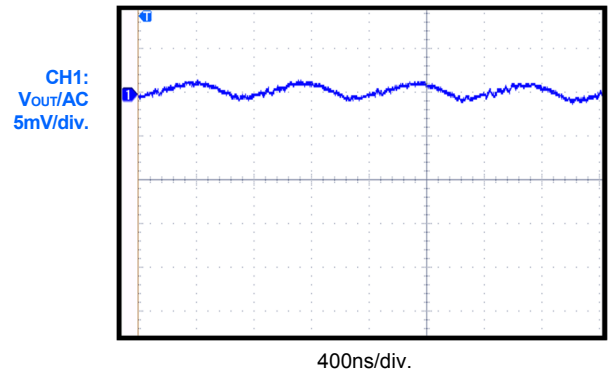

Load Transient

$I_{OUT} = 0A$ to $3A$

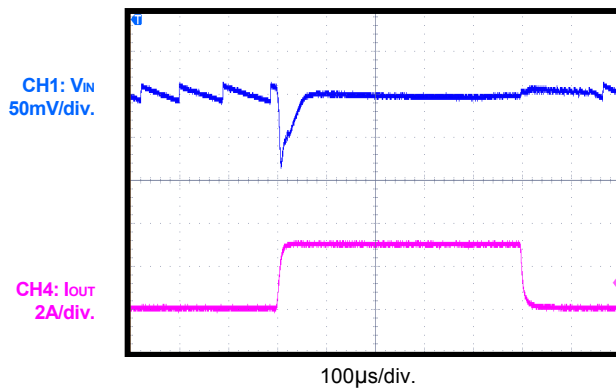

Load Transient

$I_{OUT} = 3A$ to $6A$

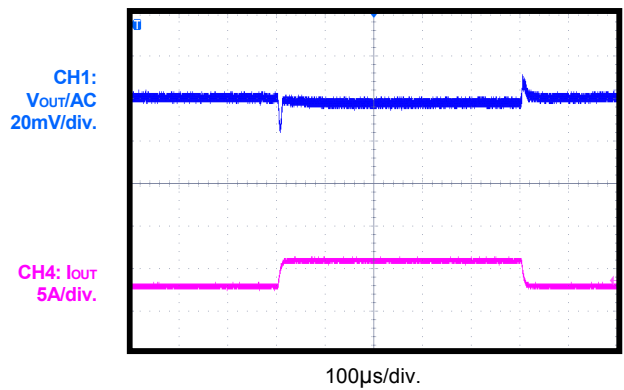

Start-Up through V_{IN}

$I_{OUT} = 0A$

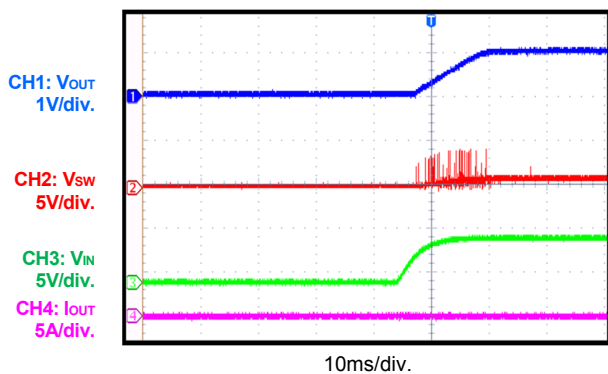

Start-Up through V_{IN}

$I_{OUT} = 6A$

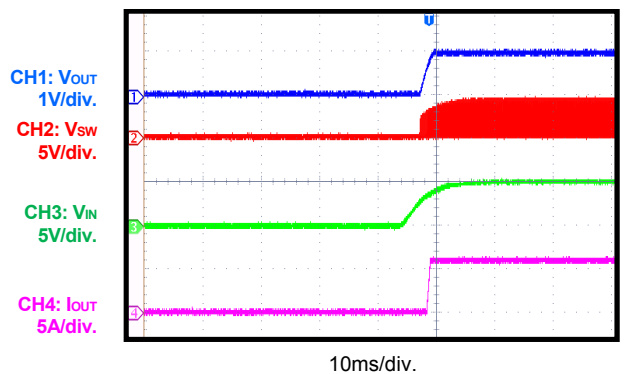

EVB TEST RESULTS (continued)

Performance curves and waveforms are tested on the evaluation board, $V_{IN} = 5V$, $V_{OUT} = 1V$, $T_A = 25^\circ C$, unless otherwise noted.

Shutdown through VIN

$I_{OUT} = 0A$

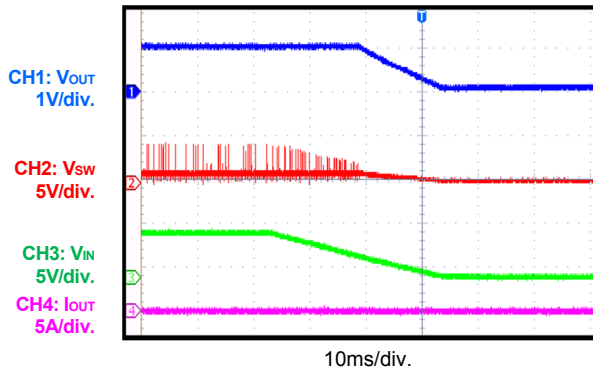

Shutdown through VIN

$I_{OUT} = 6A$

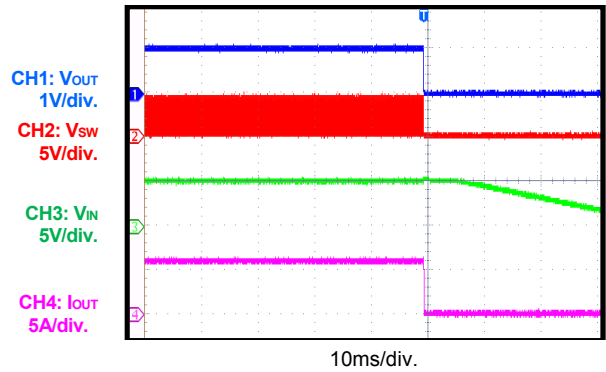

Start-Up through EN

$I_{OUT} = 0A$

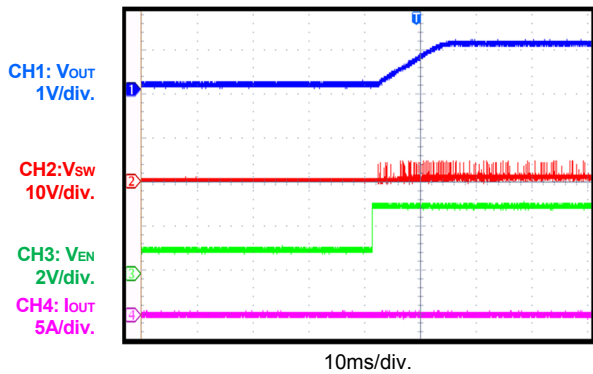

Start-Up through EN

$I_{OUT} = 6A$

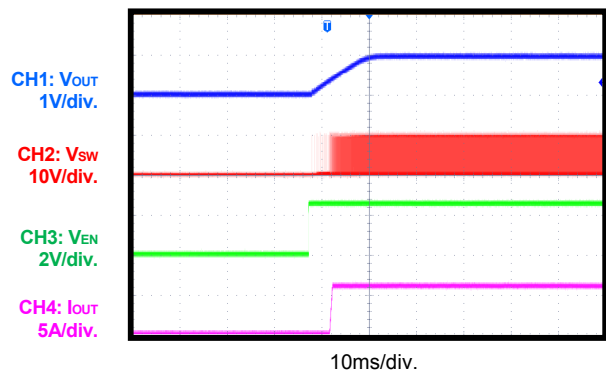

Shutdown through EN

$I_{OUT} = 0A$

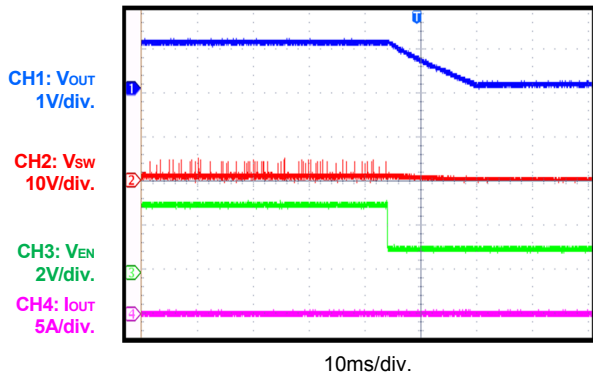

Shutdown through EN

$I_{OUT} = 6A$

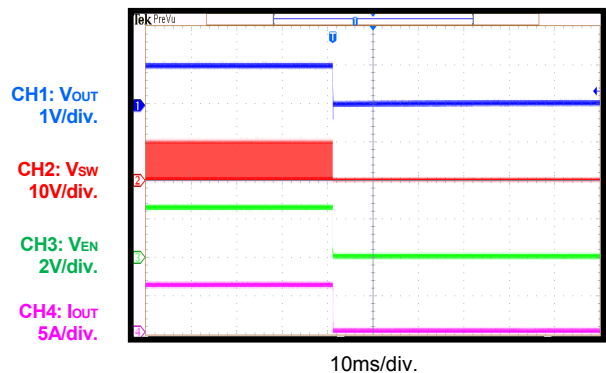

EVB TEST RESULTS *(continued)*

Performance curves and waveforms are tested on the evaluation board, $V_{IN} = 5V$, $V_{OUT} = 1V$, $T_A = 25^\circ C$, unless otherwise noted.

SCP Steady State

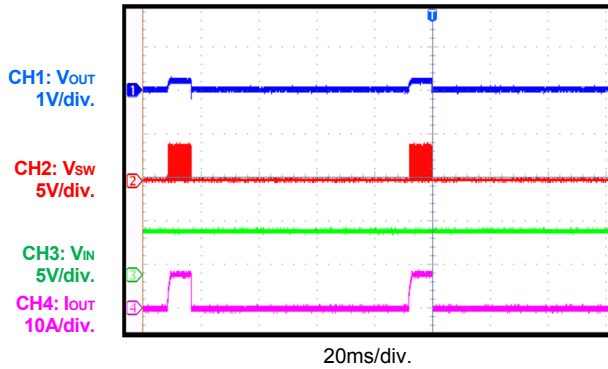

SCP Entry and Recovery

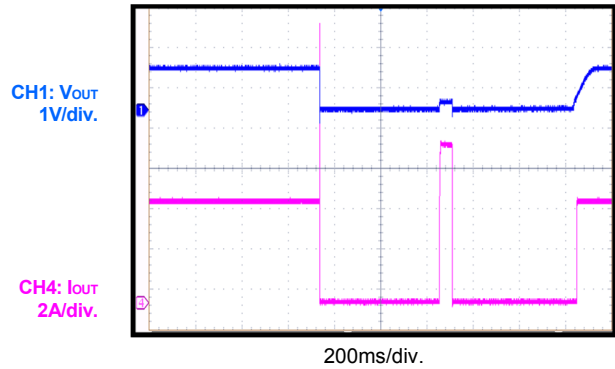

PCB LAYOUT

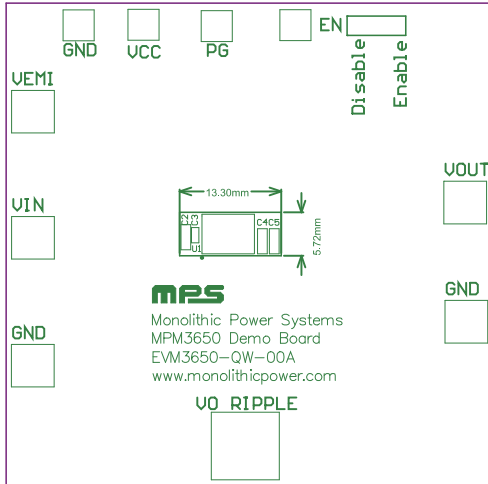

Figure 2: Top Silk

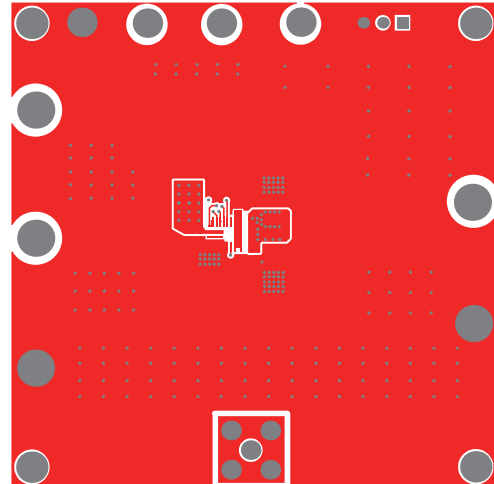

Figure 3: Top Layer

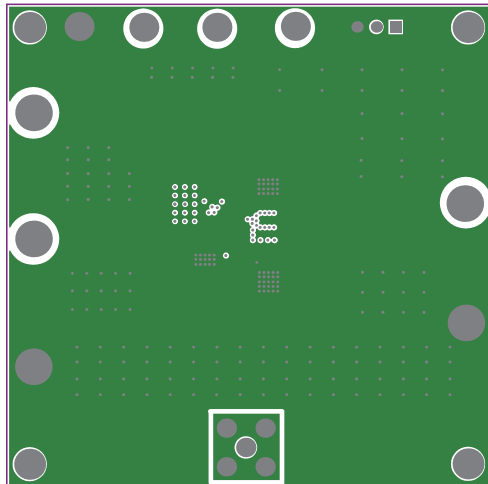

Figure 4: Mid-Layer 1

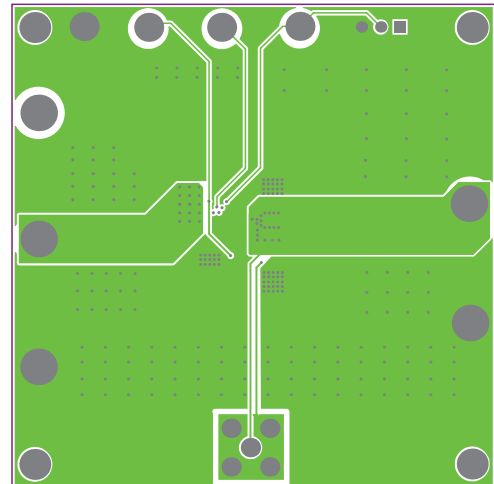

Figure 5: Mid-Layer 2

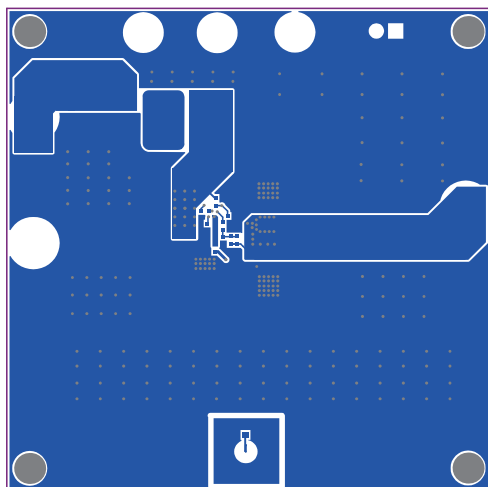

Figure 6: Bottom Layer

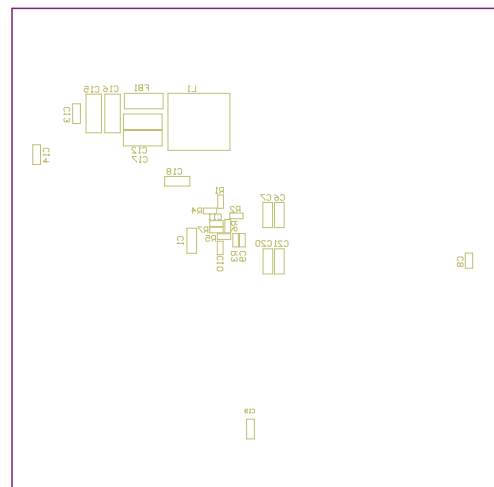

Figure 7: Bottom Silk



REVISION HISTORY

Revision #	Revision Date	Description	Pages Updated
1.0	7/8/2020	Initial Release	-
1.1	6/25/2021	Updated the output current from “5A” to “6A”; updated the output current for operation above 1.8V to “5A”; updated the Efficiency vs. Load Current vs. Power Loss graph title and axes to reflect the updated 6A output current and to include a “Power Loss” axis	1
		Updated the load current from “≤5A” to “≤6A”	2
		Updated Figure 1	3
		Updated the Bill of Materials (BOM) section	4
		Updated the Case Temperature Rise vs. Output Current curve; updated the X-axis to reflect the updated 6A output current	5
		Updated the waveform descriptions from “5A” to “6A”	6–7
		Formatting updates and clerical updates; updated figure titles	All

Notice: The information in this document is subject to change without notice. Please contact MPS for current specifications. Users should warrant and guarantee that third-party Intellectual Property rights are not infringed upon when integrating MPS products into any application. MPS will not assume any legal responsibility for any said applications.