

ES Series Sealed Tiny Slide Switches

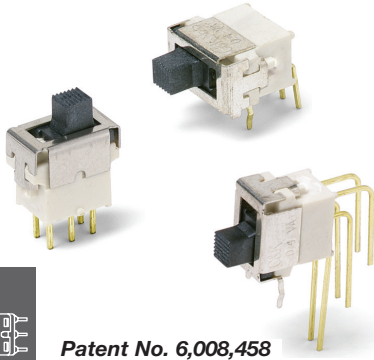

Patent No. 6,008,458

Features/Benefits

- Process compatible—internal o-ring and epoxy base seal
- Thru-hole & surface mount models
- Reliable contact design ensures long electrical life
- Robust actuator for easy actuation
- RoHS compliant

Typical Applications

- Computer peripherals & network products
- Test & measurement equipment
- Telephone & cable modems

Slide

Specifications

CONTACT RATING: 0.4 VA max. @ 20 V AC or DC max.
 MECHANICAL & ELECTRICAL LIFE: 40,000 make-and-break cycles at full load
 CONTACT RESISTANCE: 50 m Ω max. initial @ 2-4 V DC, 100 mA
 INSULATION RESISTANCE: 10⁹ Ω min.
 DIELECTRIC STRENGTH: 500 Vrms min.
 OPERATING TEMPERATURE: -30°C to 85°C
 SOLDERABILITY: Per MIL-STD-202F method 208D, or EIA RS-186E method 9
 DEGREE OF PROTECTION: IP57; Protection against harmful dust deposit, full-scale voltage protection, temporary immersion
 ESD ENDURANCE: 8kv min. (EIA 545)
 PACKAGING: Thru-hole switches supplied in anti-static trays
 Surface mount switches available in tape and reel packaging

Materials

HOUSING & BASE: Nylon (UL 94V-0)
 ACTUATOR: LCP (UL 94V-0) black, standard
 SURFACE PLATE: Stainless steel with tin plate
 MOVABLE CONTACT: Bronze with gold plate over nickel plate
 STATIONARY CONTACTS: Copper alloy, with gold plate over nickel plate
 TERMINALS: Copper alloy, with gold over nickel plate. All terminals insert molded
 BASE & TERMINAL SEAL: Epoxy

NOTE: All models RoHS compliant and compatible with all options.

NOTE: Specifications and materials listed above are for switches with standard options. For information on specific and custom switches, consult Customer Service Center.

How To Order

Our easy build-a-switch concept allows you to mix and match options to create the switch you need. To order, select desired option from each category and place it in the appropriate box.

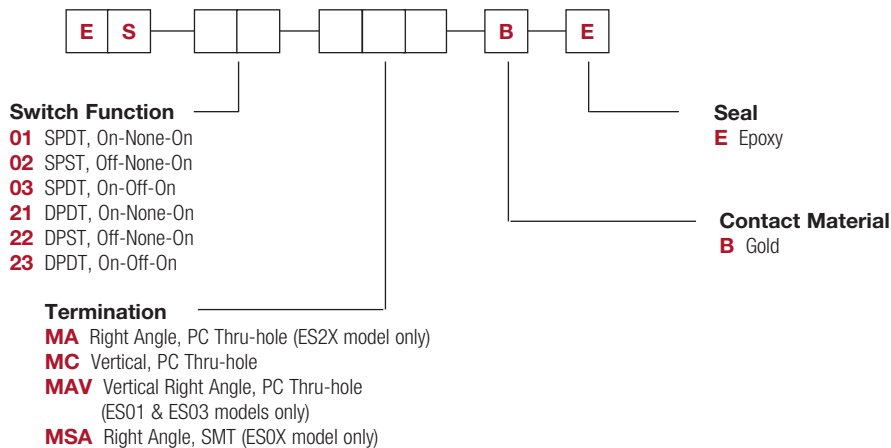

Third Angle Projection

Dimensions are shown: Inch (mm)
 Specifications and dimensions subject to change



19 Apr 22

ES Series Sealed Tiny Slide Switches



ES21MCBE
DPDT

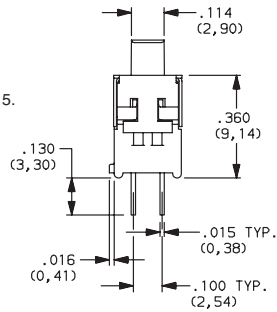
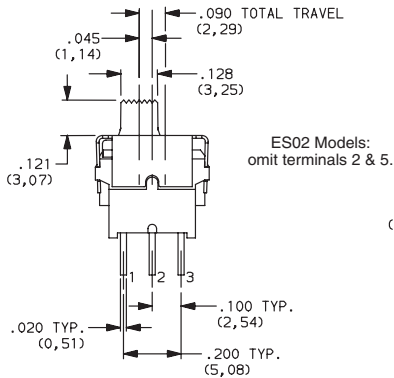
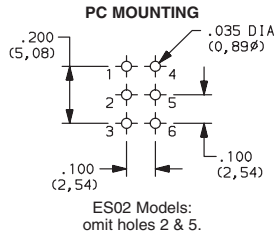
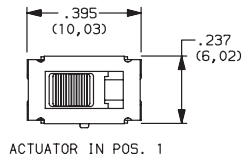

PART NUMBER	SWITCH FUNCTION		
	POS. 1	POS. 2	POS. 3
ES21MCBE	ON	NONE	ON
ES23MCBE	ON	OFF	ON
CONN. TERMINALS	2-3, 5-6	OPEN	2-1, 5-4
SCHEMATIC			
DPDT			
ES22MCBE	OFF	NONE	ON
CONN. TERMINALS	OPEN	N/A	3-1, 6-4
SCHEMATIC			
DPST			



Slide



ES21MABE
DPDT

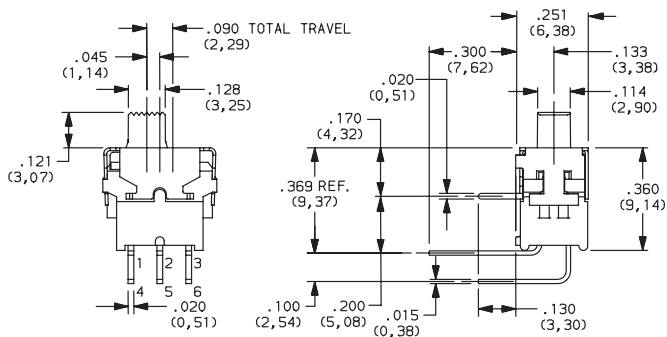
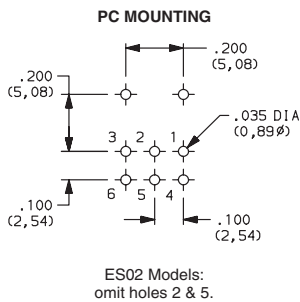
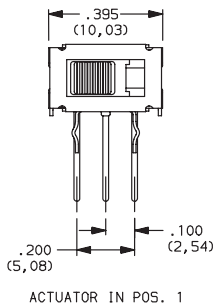

ES22 Models:
omit terminals 2 & 5.

PART NUMBER	SWITCH FUNCTION		
	POS. 1	POS. 2	POS. 3
ES21MABE	ON	NONE	ON
ES23MABE	ON	OFF	ON
CONN. TERMINALS	2-3, 5-6	OPEN	2-1, 5-4
SCHEMATIC			
DPDT			
ES22MABE	OFF	NONE	ON
CONN. TERMINALS	OPEN	N/A	3-1, 6-4
SCHEMATIC			
DPST			



Third Angle
Projection
Dimensions are shown: Inches (mm)
Specifications and dimensions subject to change

ES Series Sealed Tiny Slide Switches

Slide

PART NUMBER	SWITCH FUNCTION		
	POS. 1	POS. 2	POS. 3
ES01MAVBE	ON	NONE	ON
ES03MAVBE	ON	OFF	ON
CONN. TERMINALS	2-3	OPEN	2-1
SCHEMATIC			

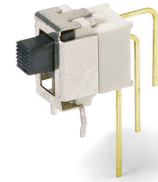
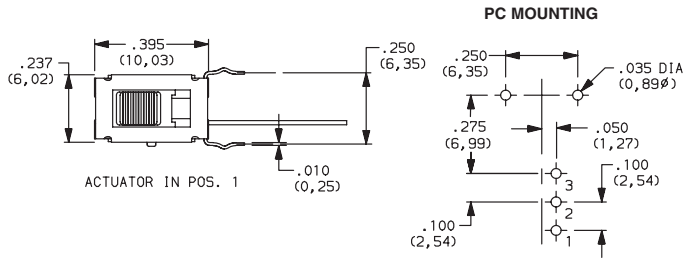

**ES01MAVBE
SPDT**

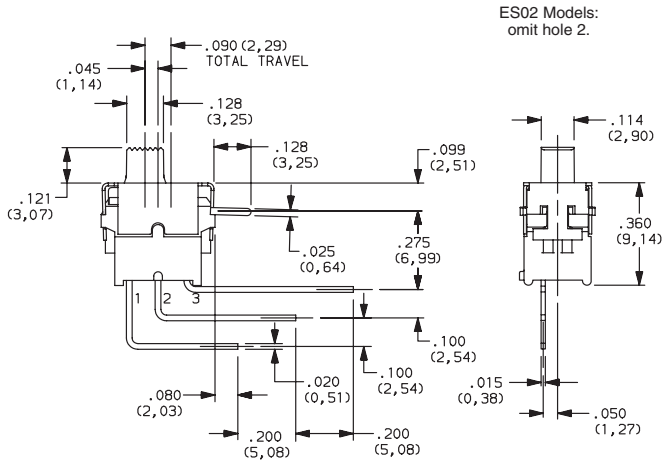

ES02 Models:
omit terminal 2.

PART NUMBER	SWITCH FUNCTION		
	POS. 1	POS. 2	POS. 3
ES01MSABE	ON	NONE	ON
ES03MSABE	ON	OFF	ON
CONN. TERMINALS	2-3	OPEN	2-1
SCHEMATIC			
SPDT			
ES02MSABE	OFF	NONE	ON
CONN. TERMINALS	OPEN	N/A	3-1
SCHEMATIC			
SPST			

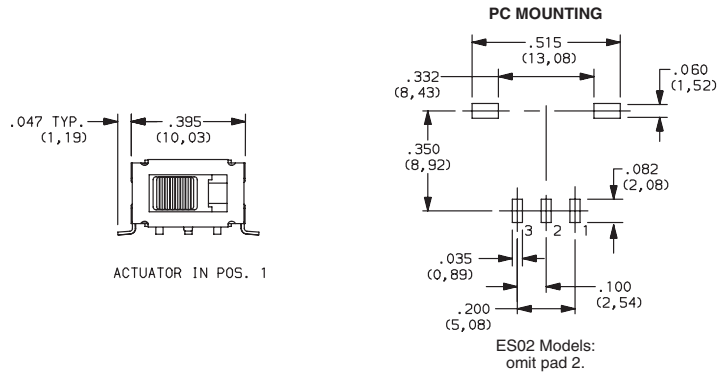

SMT

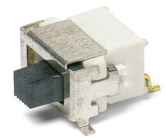

**ES01MSABE
Horizontal Actuation
SPDT**

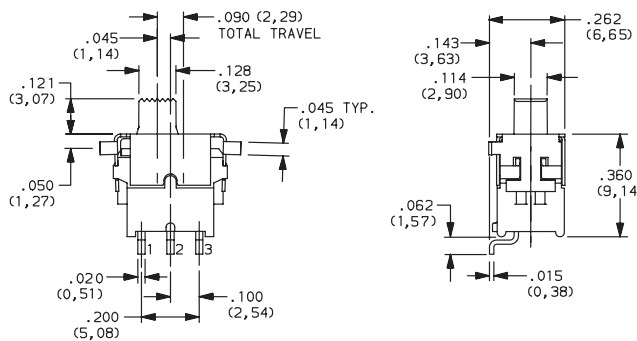

ES02 Models:
omit terminal 2.



Third Angle Projection

Dimensions are shown: Inch (mm)
Specifications and dimensions subject to change



19 Apr 22

ES Series Sealed Tiny Slide Switches

PART NUMBER	SWITCH FUNCTION		
	POS. 1	POS. 2	POS. 3
ES01MCBE	ON	NONE	ON
ES03MCBE	ON	OFF	ON
CONN. TERMINALS	2-3	OPEN	2-1
SCHEMATIC			
SPDT			
ES02MCBE	OFF	NONE	ON
CONN. TERMINALS	OPEN	N/A	3-1
SCHEMATIC			
SPST			

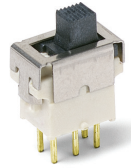
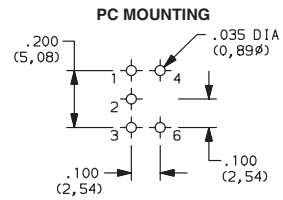
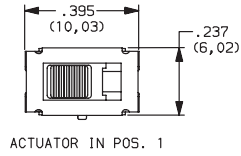

ES01MCBE
SPDT

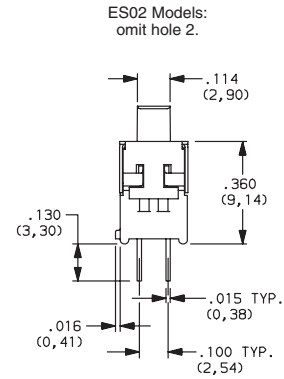
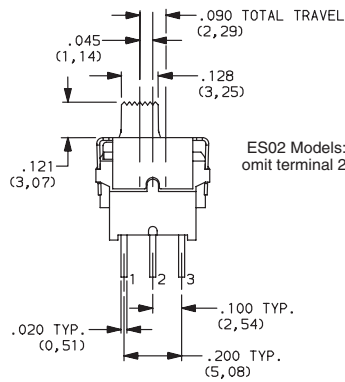

TAPE & REEL

For part numbers ESXXMSABE

REEL INFORMATION	
OUTSIDE DIAMETER	13.00 (330,0)
PILOT HOLE	.512 (13,0)
QUANTITY PER REEL	300

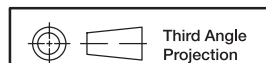
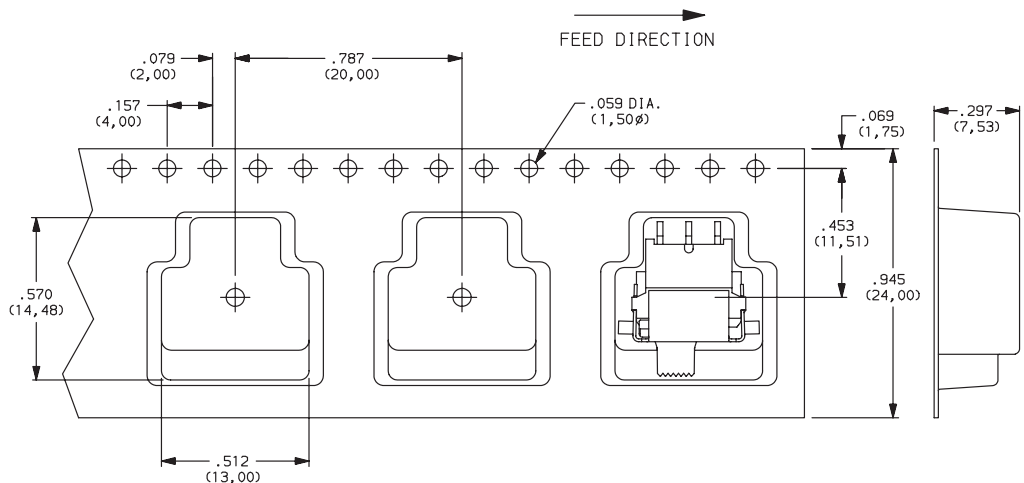

Dimensions are shown: Inches (mm)
Specifications and dimensions subject to change