

# Terminal SMD and SMDC Series

## Surface Mount



### Description

The SMD series provides surface mount overcurrent protection for applications where space is at a premium and resettable protection is desired.

### Features & Benefits

- Broadest range of resettable devices available in industry
- Low resistance
- Small footprint - 2018, 2920 and 3425
- Fast time-to-trip
- RoHS compliant, lead-free and halogen-free

### Applications

Mobile Electronics and Batteries

- Computer
- Portable electronics
- Multimedia
- Game machines
- Telephone and broadband
- Automotive
- Industrial controls
- Battery

### Additional Information



Resources



Accessories



Samples

### Agency Approvals

Agency	Agency File Number
	E74889
	78165
	50253253 72161793 72161779 72161795

### Electrical Characteristics

Part Number	Ordering Part Number	$I_H$	$I_T$	$V_{MAX}$	$I_{MAX}$	$P_{D MAX}$	Max Time-to-trip		$R_{MIN}$	$R_{1MAX}$
		(A)	(A)	(V <sub>DC</sub> )	(A)	(W)	(A)	(s)	(Ω)	(Ω)
<b>2018 Size</b>										
SMD030F-2018	RF0323-000	0.30	0.80	60	20	1.50	1.50	1.50	0.500	2.30
decaSMDC050F/60	RF1342-000	0.55	1.10	60	10	1.00	8.00	0.10	0.200	1.10
SMD100F-2018	RF0324-000	1.10	2.20	15	40	1.40	8.00	0.50	0.100	0.40
SMD150F-2018	RF0325-000	1.50	3.00	15	40	1.80	8.00	1.00	0.070	0.18
SMD200F-2018	RF0326-000	2.00	4.20	6	40	1.50	8.00	3.00	0.048	0.10
<b>2920 Size</b>										
SMD030F	RF0314-000	0.30	0.60	60	10	1.70	1.50	3.00	1.200	4.800
SMDC030F	RF4438-000	0.30	0.60	60	10	1.50	1.50	3.00	0.300	3.400
SMD050F	RF0315-000	0.50	1.00	60	10	1.70	2.50	4.00	0.350	1.400
SMDC050F	RF4439-000	0.50	1.00	60	10	1.50	2.50	4.00	0.150	1.200
SMD075F	RF0316-000	0.75	1.50	30	40	1.70	8.00	0.30	0.350	1.000
SMDC075F	RF4441-000	0.75	1.50	33	40	1.50	8.00	0.30	0.100	0.610
SMD075F/60	RF4439-000	0.75	1.50	60	10	1.70	8.00	0.30	0.350	1.000

#### Notes:

- $I_H$  : Hold current: maximum current device will pass without interruption in 20°C still air.  
 $I_T$  : Trip current: minimum current that will switch the device from low resistance to high resistance in 20°C still air.  
 $V_{MAX}$  : Maximum continuous voltage device can withstand without damage at rated current.

- $I_{MAX}$  : Maximum fault current device can withstand without damage at rated voltage.  
 $P_D$  : Power dissipated from device when in the tripped state in 20°C still air.  
 $R_{MIN}$  : Minimum resistance of device as supplied at 20°C unless otherwise specified.  
 $R_{1MAX}$  : Maximum resistance measured one hour post-trip or post-reflow at 20°C.

# Terminal SMD and SMDC Series

## Surface Mount

### Electrical Characteristics (Cont'd)

Part Number	Ordering Part Number	$I_H$	$I_T$	$V_{MAX}$	$I_{MAX}$	$P_{D MAX}$	Max Time-to-trip		$R_{MIN}$	$R_{1MAX}$
		(A)	(A)	(V <sub>DC</sub> )	(A)	(W)	(A)	(s)	(Ω)	(Ω)
<b>2920 Size</b>										
SMD100F	RF0318-000	1.10	2.20	30	40	1.70	8.00	0.50	0.120	0.480
SMD100F/33	RF0319-000	1.10	2.20	33	40	1.70	8.00	0.50	0.120	0.410
SMDH120	RF1478-000	1.20	2.30	16	50	2.00	8.00	2.00	0.150	0.340
SMD125F	RF0320-000	1.25	2.50	15	40	1.70	8.00	2.00	0.070	0.250
SMDC125F/33	RF4298-000	1.25	2.50	33	40	1.50	8.00	2.00	0.040	0.250
SMD150F/33-2920	RF2285-000	1.50	3.00	33	40	1.50	8.00	5.00	0.080	0.230
SMDC185F/33	RF3182-000	1.85	3.70	33	40	1.70	8.00	2.50	0.050	0.150
SMD200F/24-2920	RF2286-000	2.00	4.00	24	40	1.50	8.00	5.00	0.050	0.125
SMD250F/15-2920	RF2287-000	2.50	5.00	15	40	1.50	8.00	10.00	0.035	0.085
SMD260F	RF0321-000	2.60	5.20	6	40	1.70	8.00	20.00	0.025	0.075
SMD300F	RF0322-000	3.00	6.00	6	40	1.50	8.00	35.00	0.015	0.048
SMD300F/15	RF1835-000	3.00	6.00	15	40	1.50	8.00	35.00	0.015	0.050
SMDC300F/24	RF3102-000	3.00	6.00	24	40	1.70	8.00	5.00	0.015	0.072
SMDC310F/18	RF3763-000	3.10	6.00	18	50	1.50	8.00	25.00	0.013	0.036
<b>3425 Size</b>										
SMD150F	RF0308-000	1.50	3.00	15	40	1.90	8.00	5.00	0.060	0.250
SMD150F/33	RF0311-000	1.50	3.00	33	40	1.90	8.00	5.00	0.080	0.230
SMDH160	RF1479-000	1.60	3.20	16	70	2.20	8.00	15.00	0.050	0.150
SMD185F	RF1238-000	1.85	3.60	33	40	1.50	8.00	5.00	0.065	0.165
SMD200F	RF0312-000	2.00	4.00	15	40	1.90	8.00	12.00	0.050	0.125
SMD250F	RF0313-000	2.50	5.00	15	40	1.90	8.00	25.00	0.035	0.085

#### Notes:

$I_H$  : Hold current: maximum current device will pass without interruption in 20°C still air.  
 $I_T$  : Trip current: minimum current that will switch the device from low resistance to high resistance in 20°C still air.  
 $V_{MAX}$  : Maximum continuous voltage device can withstand without damage at rated current.

$I_{MAX}$  : Maximum fault current device can withstand without damage at rated voltage.  
 $P_D$  : Power dissipated from device when in the tripped state in 20°C still air.  
 $R_{MIN}$  : Minimum resistance of device as supplied at 20°C unless otherwise specified.  
 $R_{1MAX}$  : Maximum resistance measured one hour post-trip or post-reflow at 20°C.

### Temperature Derating Curve

**A = decaSMDC / SMDC and SMD**  
**B = SMDH120, SMDH160**

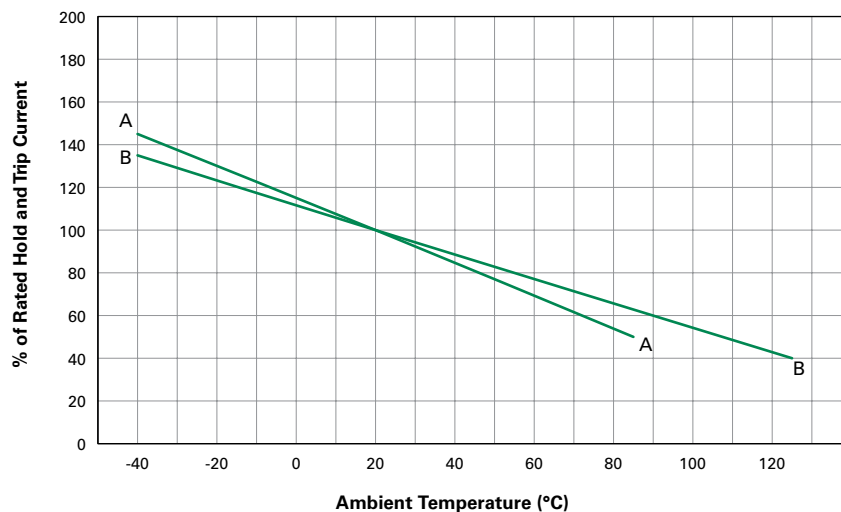

# Terminal SMD and SMDC Series

## Surface Mount

### Temperature Rerating

Part Number	Maximum Ambient Temperature											
	-40°C	-20°C	0°C	20°C	25°C	40°C	50°C	60°C	70°C	80°C	85°C	125°C
<b>Hold Current (A)</b>												
<b>Size 2018</b>												
SMD030F-2018	0.48	0.42	0.35	0.30	0.28	0.24	0.21	0.17	0.15	0.12	0.10	—
decaSMDC050F/60	1.00	0.85	0.70	0.55	0.53	0.45	0.40	0.35	0.30	0.25	0.23	—
SMD100F-2018	1.59	1.43	1.20	1.10	1.03	0.94	0.85	0.72	0.69	0.61	0.57	—
SMD150F-2018	2.21	1.97	1.70	1.50	1.43	1.26	1.15	1.00	0.91	0.79	0.73	—
SMD200F-2018	2.81	2.54	2.27	2.00	1.93	1.73	1.59	1.46	1.32	1.19	1.12	—
<b>Size 2920</b>												
SMD030F	0.44	0.39	0.32	0.30	0.28	0.26	0.23	0.19	0.18	0.17	0.15	—
SMDC030F	0.49	0.43	0.37	0.31	0.30	0.25	0.22	0.19	0.16	0.14	0.12	—
SMD050F	0.73	0.65	0.55	0.50	0.47	0.43	0.39	0.33	0.31	0.28	0.26	—
SMDC050F	0.86	0.75	0.65	0.54	0.50	0.43	0.37	0.32	0.26	0.22	0.28	—
SMD075F	1.11	0.99	0.84	0.75	0.71	0.63	0.57	0.49	0.45	0.39	0.36	—
SMDC075F	1.17	1.04	0.90	0.77	0.75	0.64	0.57	0.50	0.44	0.32	0.34	—
SMD075F/60	1.11	0.99	0.84	0.75	0.71	0.63	0.57	0.49	0.45	0.39	0.36	—
SMD100F	1.59	1.43	1.20	1.10	1.03	0.94	0.85	0.72	0.69	0.61	0.57	—
SMD100F/33	1.48	1.35	1.20	1.10	1.06	0.98	0.91	0.83	0.79	0.73	0.69	—
SMDH120	2.34	1.96	1.58	1.20	1.15	1.02	0.92	0.83	0.74	0.65	0.60	0.26
SMD125F	1.89	1.68	1.50	1.25	1.21	1.04	0.93	0.85	0.71	0.61	0.55	—
SMDC125F/33	2.02	1.78	1.55	1.31	1.25	1.08	0.96	0.84	0.72	0.60	0.54	—
SMD150F/33-2920	2.27	2.01	1.76	1.50	1.44	1.25	1.12	0.99	0.86	0.74	0.67	—
SMDC185F/33	2.83	2.50	2.20	1.85	1.74	1.53	1.37	1.22	1.04	0.88	0.80	—
SMD200F/24-2920	2.90	2.60	2.30	2.00	1.93	1.70	1.55	1.40	1.25	1.10	1.03	—
SMD250F/15-2920	3.65	3.25	2.80	2.50	2.33	2.02	1.82	1.60	1.41	1.20	1.11	—
SMD260F	3.82	3.41	2.90	2.60	2.45	2.19	1.99	1.70	1.58	1.38	1.28	—
SMD300F	4.13	3.75	3.30	3.00	2.87	2.62	2.43	2.25	2.00	1.87	1.78	—
SMD300F/15	4.20	3.80	3.30	3.00	2.90	2.62	2.43	2.25	2.00	1.87	1.78	—
SMDC300F/24	4.70	4.19	3.70	3.17	3.00	2.66	2.41	2.20	1.90	1.65	1.50	—
SMDC310F/18	4.50	4.06	3.78	3.19	3.10	2.75	2.54	2.32	2.10	1.88	1.76	—
<b>Size 3425</b>												
SMD150F	2.30	2.04	1.80	1.50	1.45	1.23	1.10	0.99	0.83	0.70	0.63	—
SMD150F/33	2.30	2.04	1.80	1.50	1.45	1.23	1.10	0.99	0.83	0.70	0.63	—
SMDH160	2.14	1.96	1.78	1.60	1.56	1.42	1.33	1.24	1.15	1.06	1.02	0.44
SMD185F	2.54	2.29	2.20	1.85	1.80	1.55	1.43	1.31	1.19	1.06	1.00	—
SMD200F	3.01	2.67	2.30	2.00	1.90	1.66	1.50	1.30	1.16	0.99	0.91	—
SMD250F	3.72	3.31	2.80	2.50	2.35	2.09	1.89	1.60	1.48	1.28	1.18	—

# Terminal SMD and SMDC Series

## Surface Mount

Typical Time-to-Trip Curves at 20°C

**midSMD**

- A = SMD030F-2018
- B = decaSMDC050F/60
- C = SMD100F-2018
- D = SMD150F-2018
- E = SMD200F-2018

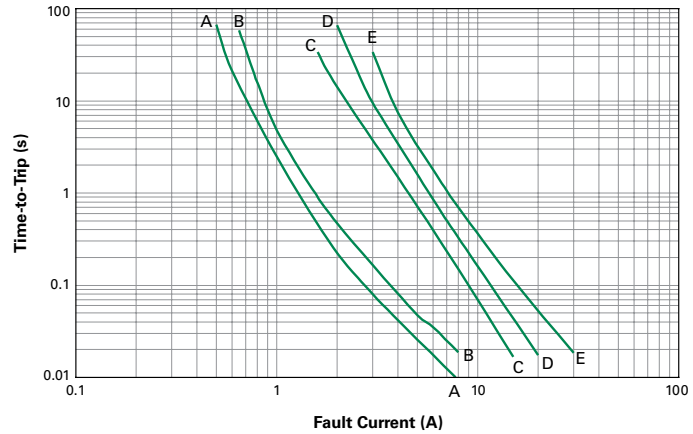

**Size 2920**

- A = SMD030F
- B = SMDC030F
- C = SMD050F
- D = SMDC050F
- E = SMD075F, SMD075F/60
- F = SMDC075F
- G = SMD100F, SMD100F/33
- H = SMDH120
- I = SMD125F
- J = SMDC125F/33
- K = SMD150F/33-2920
- L = SMDC185F/33
- M = SMD200F/24-2920
- N = SMD250F/15-2920
- O = SMD260F
- P = SMD300F, SMD300F/15
- Q = SMDC300F/24
- R = SMDC310F/18

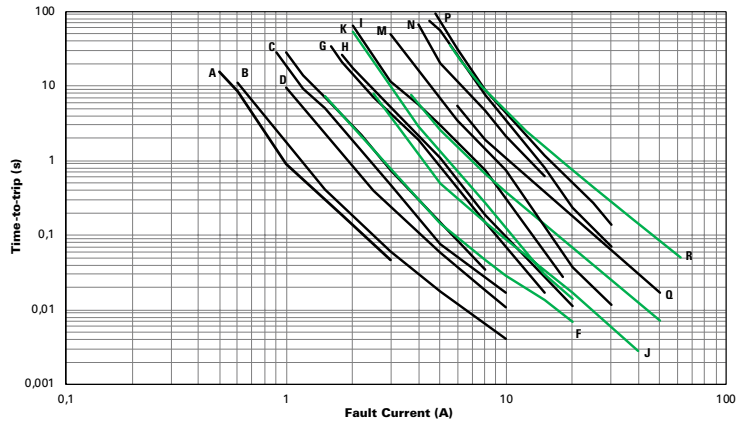

**Size 3425**

- A = SMD150F, SMD150F/33
- B = SMDH160
- C = SMD185F
- D = SMD200F
- E = SMD250F

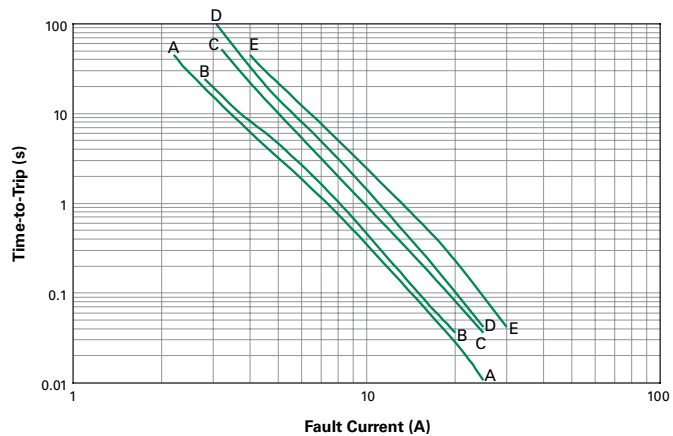

Note: The average time current curves and Temperature Derating curve performance is affected by a number of variables, and these curves provided as guidance only. Customer must verify the performance in their application.

# Terminal SMD and SMDC Series

## Surface Mount

### Physical Specifications

<b>Terminal Pad Material</b>	100% Matte Tin with Nickel Underplate
<b>Soldering Characteristics</b>	ANSI/J-STD-002 Category 3 (midSMD) ANSI/J-STD-002 Category 1 (SMD, SMD2)
<b>Solder Heat Withstand</b>	per IEC-STD 68-2-20, Test Tb, Section 5, Method 1a
<b>Flammability Resistance</b>	per IEC 695-2-2 Needle Flame Test for 20 seconds

### Environmental Specifications

Test	Test Method	Conditions	Resistance Change
<b>Storage Life</b>	PS300, Section 5.3.2	60°C, 1000 hrs	±3% typ
		85°C, 1000 hrs	±3% typ
<b>Humidity Aging</b>	PS300, Section 5.3.1	85°C, 85% R.H., 100 hrs	±1.2% typ
<b>Thermal Shock</b>	MIL-STD-202, Method 107G	85°C, -40°C (20 Times)	-33% typ
		125°C, -55°C (10 Times)	-33% typ
<b>Vibration</b>	MIL-STD-883C	per MIL-STD-883C	No Change
<b>Solvent Resistance</b>	PS300, Section 5.2.2	Freon	No Change
		Trichloroethane	No Change
		Hydrocarbons	No Change

<b>Moisture Resistance Level</b>	Level 2a, J-STD-020
<b>Storage Conditions</b>	40°C max, 70% RH max; devices should remain in original sealed bags prior to use. Devices may not meet specified values if these storage conditions are exceeded.

# Terminal SMD and SMDC Series

## Surface Mount

### Dimension Figures

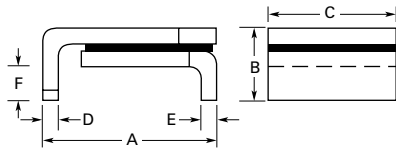

Figure 1

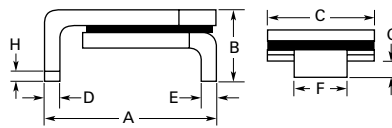

Figure 2

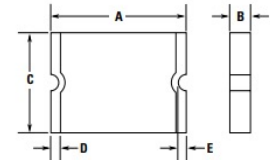

Figure 3

### Dimensions

Part Number	Dimensions in Millimeters (Inches)															Figure
	A		B		C		D		E		F		G		H	
	Min	Max	Min	Max	Min	Max	Min	Max	Min	Max	Min	Max	Min	Max	Min	
<b>Size 2018</b>																
SMD030F-2018	4.72 (0.186)	5.44 (0.214)	—	1.78 (0.070)	4.22 (0.166)	4.93 (0.194)	0.25 (0.010)	0.36 (0.014)	0.25 (0.010)	0.36 (0.014)	0.30 (0.012)	0.46 (0.018)	—	—	—	1&2
decaSMDC050F/60	4.70 (0.185)	5.31 (0.209)	0.63 (0.025)	0.89 (0.035)	4.19 (0.165)	4.81 (0.189)	0.25 (0.010)	0.95 (0.040)	0.25 (0.010)	—	—	—	—	—	—	3
SMD100F-2018	4.72 (0.186)	5.44 (0.214)	—	1.52 (0.060)	4.22 (0.166)	4.93 (0.194)	0.25 (0.010)	0.36 (0.014)	0.25 (0.010)	0.36 (0.014)	0.30 (0.012)	0.46 (0.018)	—	—	—	1&2
SMD150F-2018	4.72 (0.186)	5.44 (0.214)	—	1.52 (0.060)	4.22 (0.166)	4.93 (0.194)	0.25 (0.010)	0.36 (0.014)	0.25 (0.010)	0.36 (0.014)	0.30 (0.012)	0.46 (0.018)	—	—	—	1&2
SMD200F-2018	4.72 (0.186)	5.44 (0.214)	—	1.52 (0.060)	4.22 (0.166)	4.93 (0.194)	0.25 (0.010)	0.36 (0.014)	0.25 (0.010)	0.36 (0.014)	0.30 (0.012)	0.46 (0.018)	—	—	—	1&2
<b>Size 2920</b>																
SMD030F	6.73 (0.265)	7.98 (0.314)	—	3.18 (0.125)	4.80 (0.19)	5.44 (0.214)	0.56 (0.022)	0.71 (0.028)	0.56 (0.022)	0.71 (0.028)	2.16 (0.085)	2.41 (0.095)	0.66 (0.026)	1.37 (0.054)	0.43 (0.017)	1&2
SMDC030F	7.30 (0.287)	7.70 (0.303)	0.63 (0.025)	0.90 (0.035)	4.90 (0.193)	5.30 (0.209)	0.25 (0.010)	0.95 (0.040)	0.20 (0.008)	—	—	—	—	—	—	3
SMD050F	6.73 (0.265)	7.98 (0.314)	—	3.18 (0.125)	4.80 (0.19)	5.44 (0.214)	0.56 (0.022)	0.71 (0.028)	0.56 (0.022)	0.71 (0.028)	2.16 (0.085)	2.41 (0.095)	0.66 (0.026)	1.37 (0.054)	0.43 (0.017)	1&2
SMDC50F	7.30 (0.297)	7.70 (0.303)	0.63 (0.025)	0.90 (0.035)	4.90 (0.193)	5.30 (0.209)	0.25 (0.010)	0.95 (0.040)	0.20 (0.008)	—	—	—	—	—	—	3
SMD075F	6.73 (0.265)	7.98 (0.314)	—	3.18 (0.125)	4.80 (0.19)	5.44 (0.214)	0.56 (0.022)	0.71 (0.028)	0.56 (0.022)	0.71 (0.028)	2.16 (0.085)	2.41 (0.095)	0.66 (0.026)	1.37 (0.054)	0.43 (0.017)	1&2
SMDC075F	7.30 (0.297)	7.70 (0.303)	0.63 (0.025)	0.90 (0.035)	4.90 (0.193)	5.30 (0.209)	0.25 (0.010)	0.95 (0.040)	0.20 (0.008)	—	—	—	—	—	—	3
SMD075F/60	6.73 (0.265)	7.98 (0.314)	—	3.18 (0.125)	4.80 (0.19)	5.44 (0.214)	0.56 (0.022)	0.71 (0.028)	0.56 (0.022)	0.71 (0.028)	2.16 (0.085)	2.41 (0.095)	0.66 (0.026)	1.37 (0.054)	0.43 (0.017)	1&2
SMD100F	6.73 (0.265)	7.98 (0.314)	—	3.00 (0.118)	4.80 (0.19)	5.44 (0.214)	0.56 (0.022)	0.71 (0.028)	0.56 (0.022)	0.71 (0.028)	2.16 (0.085)	2.41 (0.095)	0.66 (0.026)	1.37 (0.054)	0.43 (0.017)	1&2
SMD100F/33	6.73 (0.265)	7.98 (0.314)	—	3.00 (0.118)	4.80 (0.19)	5.44 (0.214)	0.56 (0.022)	0.71 (0.028)	0.56 (0.022)	0.71 (0.028)	2.16 (0.085)	2.41 (0.095)	0.66 (0.026)	1.37 (0.054)	0.43 (0.017)	1&2
SMDH120	6.73 (0.265)	7.98 (0.314)	—	3.00 (0.118)	4.80 (0.19)	5.44 (0.214)	0.56 (0.022)	0.71 (0.028)	0.56 (0.022)	0.71 (0.028)	2.16 (0.085)	2.41 (0.095)	0.66 (0.026)	1.37 (0.054)	0.43 (0.017)	1&2
SMD125F	6.73 (0.265)	7.98 (0.314)	—	3.00 (0.118)	4.80 (0.19)	5.44 (0.214)	0.56 (0.022)	0.71 (0.028)	0.56 (0.022)	0.71 (0.028)	2.16 (0.085)	2.41 (0.095)	0.66 (0.026)	1.37 (0.054)	0.43 (0.017)	1&2
SMDC125F/33	7.30 (0.287)	7.70 (0.303)	0.45 (0.018)	0.71 (0.028)	4.90 (0.193)	5.30 (0.209)	0.25 (0.010)	0.95 (0.040)	0.20 (0.008)	—	—	—	—	—	—	3

# Terminal SMD and SMDC Series

## Surface Mount

### Dimension Figures

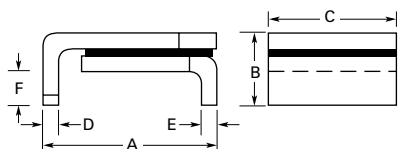

Figure 1

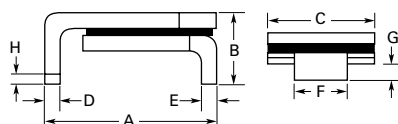

Figure 2

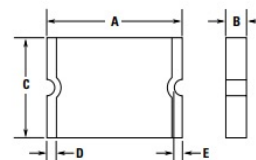

Figure 3

### Dimensions (Cont'd)

Part Number	Dimensions in Millimeters (Inches)															Figure
	A		B		C		D		E		F		G		H	
	Min	Max	Min	Max	Min	Max	Min	Max	Min	Max	Min	Max	Min	Max	Min	
<b>Size 2920</b>																
SMD150F/33-2920	6.73 (0.265)	7.98 (0.314)	—	3.00 (0.118)	4.80 (0.19)	5.44 (0.214)	0.56 (0.022)	0.71 (0.028)	0.56 (0.022)	0.71 (0.028)	2.16 (0.085)	2.41 (0.095)	0.66 (0.026)	1.37 (0.054)	0.43 (0.017)	1&2
SMDC185F/33	7.30 (0.287)	7.70 (0.303)	0.90 (0.035)	1.20 (0.047)	4.90 (0.193)	5.30 (0.209)	0.25 (0.010)	0.95 (0.040)	0.20 (0.008)	—	—	—	—	—	—	3
SMD200F/24-2920	6.73 (0.265)	7.98 (0.314)	—	3.00 (0.118)	4.80 (0.19)	5.44 (0.214)	0.56 (0.022)	0.71 (0.028)	0.56 (0.022)	0.71 (0.028)	2.16 (0.085)	2.41 (0.095)	0.66 (0.026)	1.37 (0.054)	0.43 (0.017)	1&2
SMD250F/15-2920	6.73 (0.265)	7.98 (0.314)	—	3.00 (0.118)	4.80 (0.19)	5.44 (0.214)	0.56 (0.022)	0.71 (0.028)	0.56 (0.022)	0.71 (0.028)	2.16 (0.085)	2.41 (0.095)	0.66 (0.026)	1.37 (0.054)	0.43 (0.017)	1&2
SMD260F	6.73 (0.265)	7.98 (0.314)	—	3.00 (0.118)	4.80 (0.19)	5.44 (0.214)	0.56 (0.022)	0.71 (0.028)	0.56 (0.022)	0.71 (0.028)	2.16 (0.085)	2.41 (0.095)	0.66 (0.026)	1.37 (0.054)	0.43 (0.017)	1&2
SMD300F	6.73 (0.265)	7.98 (0.314)	—	3.00 (0.118)	4.80 (0.19)	5.44 (0.214)	0.56 (0.022)	0.71 (0.028)	0.56 (0.022)	0.71 (0.028)	2.16 (0.085)	2.41 (0.095)	0.66 (0.026)	1.37 (0.054)	0.43 (0.017)	1&2
SMD300F/15	6.73 (0.265)	7.98 (0.314)	—	3.00 (0.118)	4.80 (0.19)	5.44 (0.214)	0.56 (0.022)	0.71 (0.028)	0.56 (0.022)	0.71 (0.028)	2.16 (0.085)	2.41 (0.095)	0.66 (0.026)	1.37 (0.054)	0.43 (0.017)	1&2
SMDC300F/24	7.30 (0.287)	7.70 (0.303)	0.80 (0.031)	1.10 (0.043)	4.90 (0.193)	5.30 (0.209)	0.25 (0.010)	0.95 (0.040)	0.20 (0.008)	—	—	—	—	—	—	3
SMD310F/18	7.30 (0.287)	7.70 (0.303)	1.10 (0.043)	1.70 (0.067)	4.90 (0.193)	5.30 (0.209)	0.95 (0.040)	1.45 (0.057)	0.35 (0.014)	—	—	—	—	—	—	3
<b>Size 3425</b>																
SMD150F	8.00 (0.315)	9.40 (0.370)	—	3.00 (0.118)	6.00 (0.236)	6.71 (0.264)	0.56 (0.022)	0.71 (0.028)	0.56 (0.022)	0.71 (0.028)	3.68 (0.145)	3.94 (0.155)	0.66 (0.026)	1.37 (0.054)	0.43 (0.017)	1&2
SMD150F/33	8.00 (0.315)	9.40 (0.370)	—	3.00 (0.118)	6.00 (0.236)	6.71 (0.264)	0.56 (0.022)	0.71 (0.028)	0.56 (0.022)	0.71 (0.028)	3.68 (0.145)	3.94 (0.155)	0.66 (0.026)	1.37 (0.054)	0.43 (0.017)	1&2
SMDH160	8.00 (0.315)	9.40 (0.370)	—	3.00 (0.118)	6.00 (0.236)	6.71 (0.264)	0.56 (0.022)	0.71 (0.028)	0.56 (0.022)	0.71 (0.028)	3.68 (0.145)	3.94 (0.155)	0.66 (0.026)	1.37 (0.054)	0.43 (0.017)	1&2
SMD185F	8.00 (0.315)	9.40 (0.370)	—	3.00 (0.118)	6.00 (0.236)	6.71 (0.264)	0.56 (0.022)	0.71 (0.028)	0.56 (0.022)	0.71 (0.028)	3.68 (0.145)	3.94 (0.155)	0.66 (0.026)	1.37 (0.054)	0.43 (0.017)	1&2
SMD200F	8.00 (0.315)	9.40 (0.370)	—	3.00 (0.118)	6.00 (0.236)	6.71 (0.264)	0.56 (0.022)	0.71 (0.028)	0.56 (0.022)	0.71 (0.028)	3.68 (0.145)	3.94 (0.155)	0.66 (0.026)	1.37 (0.054)	0.43 (0.017)	1&2
SMD250F	8.00 (0.315)	9.40 (0.370)	—	3.00 (0.118)	6.00 (0.236)	6.71 (0.264)	0.56 (0.022)	0.71 (0.028)	0.56 (0.022)	0.71 (0.028)	3.68 (0.145)	3.94 (0.155)	0.66 (0.026)	1.37 (0.054)	0.43 (0.017)	1&2

# Terminal SMD and SMDC Series

## Surface Mount

### Recommended Pad Layout

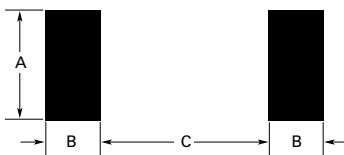

### Packaging and Marking Information

Part Number	Tape and Reel Quantity	Standard Package	Part Marking	Recommended Pad Layout Figures [mm (in)]			Agency Recognition
				Dimension A (Nom)	Dimension B (Nom)	Dimension C (Nom)	
<b>Size 2018</b>							
SMD030F-2018	4,000	20,000	A03F	4.60 (0.18)	1.50 (0.059)	3.40 (0.134)	UL, CSA, TÜV
decaSMDC050F/60	1,000	5,000	050F 60V	4.32 (0.17)	1.40 (0.55)	3.61 (0.142)	UL, CSA, TÜV
SMD100F-2018	4,000	20,000	A10F	4.60 (0.18)	1.50 (0.059)	3.40 (0.134)	UL, CSA, TÜV
SMD150F-2018	4,000	20,000	A15F	4.60 (0.18)	1.50 (0.059)	3.40 (0.134)	UL, CSA, TÜV
SMD200F-2018	4,000	20,000	A20F	4.60 (0.18)	1.50 (0.059)	3.40 (0.134)	UL, CSA, TÜV
<b>Size 2820</b>							
SMD030F	2,000	10,000	030F	3.10 (0.12)	2.30 (0.09)	5.10 (0.201)	UL, CSA, TÜV
SMDC030F	4,000	20,000	030F	5.30 (0.209)	2.00 (0.079)	4.60 (0.18)	-
SMD050F	2,000	10,000	050F	3.10 (0.12)	2.30 (0.09)	5.10 (0.201)	UL, CSA, TÜV
SMDC050F	4,000	20,000	050F	5.30 (0.209)	2.00 (0.079)	4.60 (0.18)	-
SMD075F	2,000	10,000	075F	3.10 (0.12)	2.30 (0.09)	5.10 (0.201)	UL, CSA, TÜV
SMDC075F	4,000	20,000	075F	5.30 (0.209)	2.00 (0.079)	4.60 (0.18)	-
SMD075F/60	2,000	10,000	756F	3.10 (0.12)	2.30 (0.09)	5.10 (0.201)	UL, CSA, TÜV
SMD100F	2,000	10,000	100F	3.10 (0.12)	2.30 (0.09)	5.10 (0.201)	UL, CSA, TÜV
SMD100F/33	2,000	10,000	103F	3.10 (0.12)	2.30 (0.09)	5.10 (0.201)	UL, CSA, TÜV
SMDH120	2,000	10,000	H12	3.10 (0.12)	2.30 (0.09)	5.10 (0.201)	UL, CSA, TÜV
SMD125F	2,000	10,000	125F	3.10 (0.12)	2.30 (0.09)	5.10 (0.201)	UL, CSA, TÜV
SMDC125F/33	4,000	20,000	125F	5.30 (0.209)	2.00 (0.079)	4.60 (0.18)	UL
SMD150F/33-2920	2,000	10,000	S15F	3.10 (0.12)	2.30 (0.09)	5.10 (0.201)	UL, CSA, TÜV
SMDC185F/33	4,000	20,000	185F 33V	5.30 (0.209)	2.00 (0.079)	4.60 (0.18)	UL, CSA, TÜV
SMD200F/24-2920	2,000	10,000	S20F	3.10 (0.12)	2.30 (0.09)	5.10 (0.201)	UL, CSA, TÜV
SMD250F/15-2920	2,000	10,000	S25F	3.10 (0.12)	2.30 (0.09)	5.10 (0.201)	UL, CSA, TÜV
SMD260F	2,000	10,000	260F	3.10 (0.12)	2.30 (0.09)	5.10 (0.201)	UL, CSA, TÜV
SMD300F	2,000	10,000	300F	3.10 (0.12)	2.30 (0.09)	5.10 (0.201)	UL, CSA, TÜV
SMD300F/15	2,000	10,000	315F	3.10 (0.12)	2.30 (0.09)	5.10 (0.201)	UL, CSA, TÜV
SMDC300F/24	4,000	20,000	300F 24V	5.30 (0.209)	2.00 (0.079)	4.60 (0.18)	UL, CSA, TÜV
SMD310F/18	3,000	15,000	310F18V	5.30 (0.209)	2.00 (0.079)	4.60 (0.18)	UL, CSA, TÜV
<b>Size 3425</b>							
SMD150F	1,500	7,500	150F	4.60 (0.18)	2.30 (0.09)	6.10 (0.240)	UL, CSA, TÜV
SMD150F/33	1,500	7,500	153F	4.60 (0.18)	2.30 (0.09)	6.10 (0.240)	UL, CSA, TÜV
SMDH160	1,500	7,500	160F	4.60 (0.18)	2.30 (0.09)	6.10 (0.240)	UL, CSA, TÜV
SMD185F	1,500	7,500	185F	4.60 (0.18)	2.30 (0.09)	6.10 (0.240)	UL, CSA, TÜV
SMD200F	1,500	7,500	200F	4.60 (0.18)	2.30 (0.09)	6.10 (0.240)	UL, CSA, TÜV
SMD250F	1,500	7,500	250F	4.60 (0.18)	2.30 (0.09)	6.10 (0.240)	UL, CSA, TÜV



# Terminal SMD and SMDC Series

## Surface Mount

### Solder Reflow Recommendations

<b>Profile Feature</b>	Pb-Free Assembly
<b>Average ramp up rate (<math>T_{S\_MAX}</math> to <math>T_p</math>)</b>	3°C/s max
<b>Preheat</b>	
• Temperature min ( $T_{S\_MIN}$ )	150°C
• Temperature max ( $T_{S\_MAX}$ )	200°C
• Time ( $t_{S\_MIN}$ to $t_{S\_MAX}$ )	60-120 s
<b>Time maintained above:</b>	
• Temperature ( $T_L$ )	217°C
• Time ( $t_L$ )	60-150 s
<b>Peak/Classification temperature (<math>T_p</math>)</b>	260°C
<b>Time within 5°C of actual peak temperature</b>	
Time ( $t_p$ )	30 s max
<b>Ramp down rate</b>	3°C/s max
<b>Time 25°C to peak temperature</b>	8 min max

**Note:** All temperatures refer to topside of the package, measured on the package body surface.

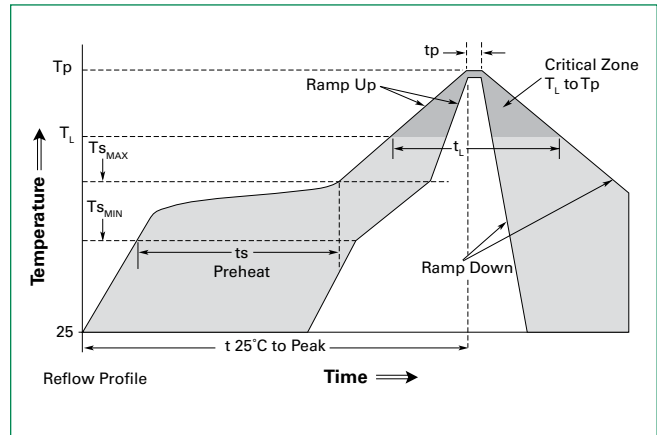

#### Solder Reflow

- Recommended reflow method: IR, hot air, nitrogen.
- Recommended maximum paste thickness: 0.25mm (0.010in)
- Devices can be cleaned using standard methods and aqueous solvents.
- Experience has shown the optimum conditions for forming acceptable solder fillets occur when a reasonable amount of solder paste is placed underneath each device's termination. As such, we request that customers comply with our recommended solder pad layouts.
- Customer should validate that the solder paste amount and reflow recommendations meet its application.
- We request that customer board layouts refrain from placing raised features (e.g. vias, nomenclature, traces, etc.) underneath PolySwitch devices. It is possible that raised features could negatively impact solderability performance of our devices.

#### Rework

- Standard industry practices. (Please also avoid direct contact to the device.)

### Part Ordering Number System

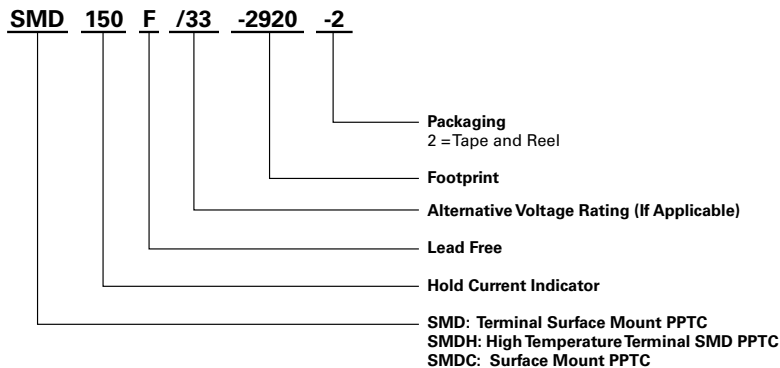

# Terminal SMD and SMDC Series

## Surface Mount

### Tape and Reel Specifications

Description	2018 Size EIA 481-2(mm)		2920 Size EIA 481-2(mm)				3425 Size EIA 481-2(mm)	
	SMD030F-2018 SMD100F-2018 SMD150F-2018 SMD200F-2018	decaSMDC050F/60	SMD030F SMD050F SMD075F SMD075F/60 SMD100F SMD100F/33 SMDH120	SMD125F SMD150F/33-2920 SMD200F/24-2920 SMD250F/15-2920 SMD260F SMD300F SMD300F/15	SMDC030F SMDC050F SMDC075F SMDC125F/33	SMDC185F/33 SMDC300F/24	SMDC310F/18	SMD150F SMD150F/33 SMDH160 SMD185F SMD200F SMD250F
<b>W</b>	16.0 ± 0.30	12.0 ± 0.30	16.0 ± 0.30	16.0 ± 0.30	16.0 ± 0.30	16.0 ± 0.30	16.0 ± 0.30	16.0 ± 0.30
<b>P<sub>0</sub></b>	4.0 ± 0.10	4.0 ± 0.10	4.0 ± 0.10	4.0 ± 0.10	4.0 ± 0.10	4.0 ± 0.10	4.0 ± 0.10	4.0 ± 0.10
<b>P<sub>1</sub></b>	8.0 ± 0.10	8.0 ± 0.10	8.0 ± 0.10	8.0 ± 0.10	8.0 ± 0.10	8.0 ± 0.10	8.0 ± 0.10	12.0 ± 0.10
<b>P<sub>2</sub></b>	2.0 ± 0.10	2.0 ± 0.05	2.0 ± 0.10	2.0 ± 0.10	2.0 ± 0.10	2.0 ± 0.10	2.0 ± 0.10	2.0 ± 0.10
<b>A<sub>0</sub></b>	5.11 ± 0.15	5.0 ± 0.1	5.6 ± 0.23	5.5 ± 0.1	5.35 ± 0.1	5.5 ± 0.1	6.9 ± 0.23	
<b>B<sub>0</sub></b>	5.6 ± 0.23	5.4 ± 0.1	8.1 ± 0.15	7.9 ± 0.1	7.85 ± 0.1	8.0 ± 0.1	9.6 ± 0.15	
<b>B<sub>1 max</sub></b>	6.4	6,2	12.1	12,1	12,1	12,1	12.1	
<b>D<sub>0</sub></b>	1.5 + 0.10/-0.00	1.55 ± 0.05	1.5 + 0.10/-0.00	1.5 + 0.10/-0.00	1.5 + 0.10/-0.00	1.5 + 0.10/-0.00	1.5 + 0.10/-0.00	
<b>F</b>	7.50 ± 0.10	5.50 ± 0.10	7.50 ± 0.10	7.50 ± 0.10	7.50 ± 0.10	7.50 ± 0.10	7.50 ± 0.10	
<b>E<sub>1</sub></b>	1.75 ± 0.10	1.75 ± 0.10	1.75 ± 0.10	1.75 ± 0.10	1.75 ± 0.10	1.75 ± 0.10	1.75 ± 0.10	
<b>E<sub>2 min</sub></b>	14.25	10,25	14.25	14,25	14,25	14,25	14.25	
<b>T max</b>	0.4	0,4	0.4	0,35	0,35	0,35	0.4	
<b>T<sub>1 max</sub></b>	0.1	0,1	0.1	0,1	0,1	0,1	0.1	
<b>K<sub>0</sub></b>	1.8 ± 0.15	1.7 ± 0.1	3.2 ± 0.15	0.9 ± 0.1	1.45 ± 0.1	2.0 ± 0.1	3.4 ± 0.15	
<b>A max</b>	330	330	330	330	330	330	330	
<b>N min</b>	50	50	50	50	50	50	50	
<b>W<sub>1</sub></b>	16.4 + 2.0/-0.00	16.4 + 2.0/-0.00	16.4 + 2.0/-0.00	16.4 + 2.0/-0.00	16.4 + 2.0/-0.00	16.4 + 2.0/-0.00	16.4 + 2.0/-0.00	
<b>W<sub>2 max</sub></b>	22.4	22.4	22.4	22.4	22.4	22.4	22.4	

# Terminal SMD and SMDC Series

## Surface Mount

### Tape and Reel Diagrams

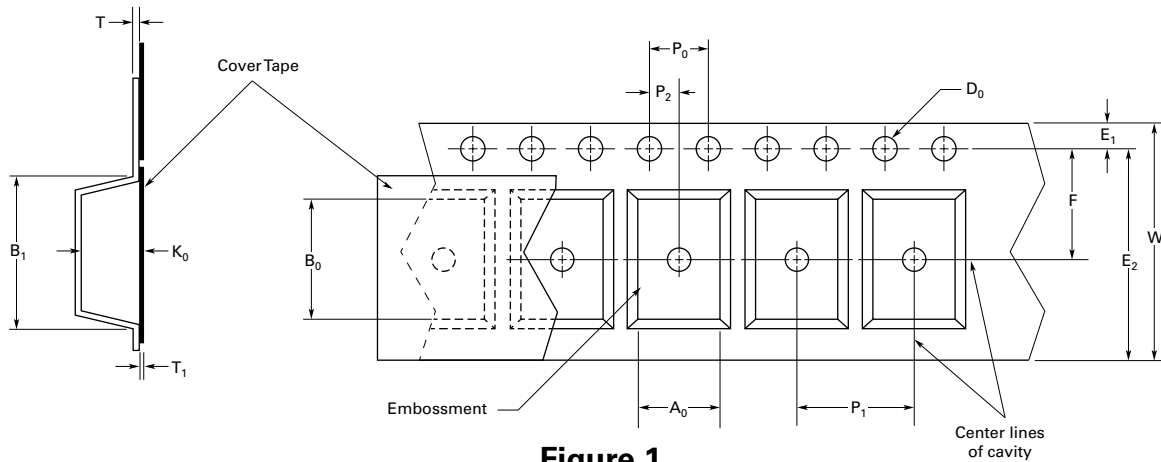

Figure 1

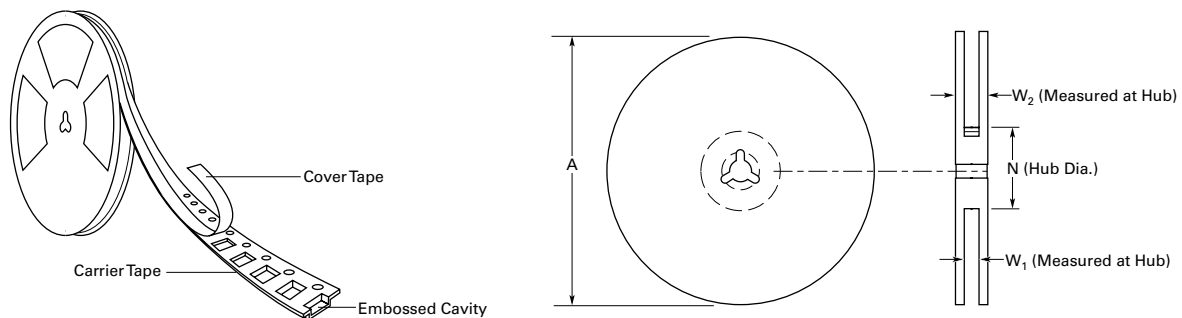

Figure 2

#### Warning

- Users should independently evaluate the suitability of and test each product selected for their own application.
- Operation beyond the maximum ratings or improper use may result in device damage and possible electrical arcing and flame.
- These devices are intended for protection against damage caused by occasional overcurrent or overtemperature fault conditions and should not be used when repeated fault conditions or prolonged trip events are anticipated.
- Contamination of the PPTC material with certain silicone-based oils or some aggressive solvents can adversely impact the performance of the devices.
- Device performance can be impacted negatively if devices are handled in a manner inconsistent with recommended electronic, thermal, and mechanical procedures for electronic components.
- PPTC devices are not recommended for installation in applications where the device is constrained such that its PTC properties are inhibited, for example in rigid potting materials or in rigid housings, which lack adequate clearance to accommodate device expansion.
- Operation in circuits with a large inductance can generate a circuit voltage ( $Ldi/dt$ ) above the rated voltage of the device.

**Disclaimer Notice** - Information furnished is believed to be accurate and reliable. However, users should independently evaluate the suitability of and test each product selected for their own applications. Littelfuse products are not designed for, and may not be used in, all applications. Read complete Disclaimer Notice at [www.littelfuse.com/disclaimer-electronics](http://www.littelfuse.com/disclaimer-electronics).