

ON Semiconductor

Is Now

onsemi™

To learn more about onsemi™, please visit our website at
www.onsemi.com

onsemi and **onsemi** and other names, marks, and brands are registered and/or common law trademarks of Semiconductor Components Industries, LLC dba "**onsemi**" or its affiliates and/or subsidiaries in the United States and/or other countries. **onsemi** owns the rights to a number of patents, trademarks, copyrights, trade secrets, and other intellectual property. A listing of **onsemi** product/patent coverage may be accessed at www.onsemi.com/site/pdf/Patent-Marking.pdf. **onsemi** reserves the right to make changes at any time to any products or information herein, without notice. The information herein is provided "as-is" and **onsemi** makes no warranty, representation or guarantee regarding the accuracy of the information, product features, availability, functionality, or suitability of its products for any particular purpose, nor does **onsemi** assume any liability arising out of the application or use of any product or circuit, and specifically disclaims any and all liability, including without limitation special, consequential or incidental damages. Buyer is responsible for its products and applications using **onsemi** products, including compliance with all laws, regulations and safety requirements or standards, regardless of any support or applications information provided by **onsemi**. "Typical" parameters which may be provided in **onsemi** data sheets and/or specifications can and do vary in different applications and actual performance may vary over time. All operating parameters, including "Typicals" must be validated for each customer application by customer's technical experts. **onsemi** does not convey any license under any of its intellectual property rights nor the rights of others. **onsemi** products are not designed, intended, or authorized for use as a critical component in life support systems or any FDA Class 3 medical devices or medical devices with a same or similar classification in a foreign jurisdiction or any devices intended for implantation in the human body. Should Buyer purchase or use **onsemi** products for any such unintended or unauthorized application, Buyer shall indemnify and hold **onsemi** and its officers, employees, subsidiaries, affiliates, and distributors harmless against all claims, costs, damages, and expenses, and reasonable attorney fees arising out of, directly or indirectly, any claim of personal injury or death associated with such unintended or unauthorized use, even if such claim alleges that **onsemi** was negligent regarding the design or manufacture of the part. **onsemi** is an Equal Opportunity/Affirmative Action Employer. This literature is subject to all applicable copyright laws and is not for resale in any manner. Other names and brands may be claimed as the property of others.



Is Now Part of



ON Semiconductor®

To learn more about ON Semiconductor, please visit our website at
www.onsemi.com

Please note: As part of the Fairchild Semiconductor integration, some of the Fairchild orderable part numbers will need to change in order to meet ON Semiconductor's system requirements. Since the ON Semiconductor product management systems do not have the ability to manage part nomenclature that utilizes an underscore (_), the underscore (_) in the Fairchild part numbers will be changed to a dash (-). This document may contain device numbers with an underscore (_). Please check the ON Semiconductor website to verify the updated device numbers. The most current and up-to-date ordering information can be found at www.onsemi.com. Please email any questions regarding the system integration to Fairchild_questions@onsemi.com.

ON Semiconductor and the ON Semiconductor logo are trademarks of Semiconductor Components Industries, LLC dba ON Semiconductor or its subsidiaries in the United States and/or other countries. ON Semiconductor owns the rights to a number of patents, trademarks, copyrights, trade secrets, and other intellectual property. A listing of ON Semiconductor's product/patent coverage may be accessed at www.onsemi.com/site/pdf/Patent-Marking.pdf. ON Semiconductor reserves the right to make changes without further notice to any products herein. ON Semiconductor makes no warranty, representation or guarantee regarding the suitability of its products for any particular purpose, nor does ON Semiconductor assume any liability arising out of the application or use of any product or circuit, and specifically disclaims any and all liability, including without limitation special, consequential or incidental damages. Buyer is responsible for its products and applications using ON Semiconductor products, including compliance with all laws, regulations and safety requirements or standards, regardless of any support or applications information provided by ON Semiconductor. "Typical" parameters which may be provided in ON Semiconductor data sheets and/or specifications can and do vary in different applications and actual performance may vary over time. All operating parameters, including "Typicals" must be validated for each customer application by customer's technical experts. ON Semiconductor does not convey any license under its patent rights nor the rights of others. ON Semiconductor products are not designed, intended, or authorized for use as a critical component in life support systems or any FDA Class 3 medical devices or medical devices with a same or similar classification in a foreign jurisdiction or any devices intended for implantation in the human body. Should Buyer purchase or use ON Semiconductor products for any such unintended or unauthorized application, Buyer shall indemnify and hold ON Semiconductor and its officers, employees, subsidiaries, affiliates, and distributors harmless against all claims, costs, damages, and expenses, and reasonable attorney fees arising out of, directly or indirectly, any claim of personal injury or death associated with such unintended or unauthorized use, even if such claim alleges that ON Semiconductor was negligent regarding the design or manufacture of the part. ON Semiconductor is an Equal Opportunity/Affirmative Action Employer. This literature is subject to all applicable copyright laws and is not for resale in any manner.

FODM8061

High Noise Immunity, 3.3V/5V, 10Mbit/sec Logic Gate Output (Open Collector) Optocoupler

Features

- High Noise Immunity characterized by common mode transient immunity (CMTi)
 - 20kV/ μ s Minimum CMTi
- High Speed
 - 10Mbit/sec Data Rate (NRZ)
 - 80ns max. Propagation Delay
 - 25ns max. Pulse Width Distortion
 - 40ns max. Propagation Delay Skew
- 3.3V LVTTTL/LVCMOS Compatibility
- Specifications guaranteed over 3V to 5.5V supply voltage and -40°C to +110°C temperature range
- Safety and regulatory approvals
 - UL1577, 3750 VAC_{RMS} for 1 min.
 - DIN EN/IEC60747-5-5

Applications

- Microprocessor system interface
 - SPI, I²C
- Industrial fieldbus communications
 - DeviceNet, CAN, RS485
- Programmable logic control
- Isolated data acquisition system
- Voltage level translator
- Isolating MOSFET/IGBT gate drivers

Description

The FODM8061 is a 3.3V/5V high-speed logic gate output (open collector) optocoupler, which supports isolated communications allowing digital signals to communicate between systems without conducting ground loops or hazardous voltages. It utilizes Fairchild's patented coplanar packaging technology, Optoplanar[®], and optimized IC design to achieve high noise immunity, characterized by high common mode transient immunity specifications.

This optocoupler consists of an AlGaAS LED at the input, optically coupled to a high speed integrated photo-detector logic gate. The output of the detector IC is an open collector schottky-clamped transistor. The coupled parameters are guaranteed over the wide temperature range of -40°C to +110°C. A maximum input signal of 5mA will provide a minimum output sink current of 13mA (fan out of 8).

Related Resources

- www.fairchildsemi.com/products/opto/
- www.fairchildsemi.com/pf/FO/FODM611.html
- www.fairchildsemi.com/pf/FO/FODM8071.html

Functional Schematic

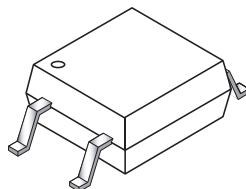
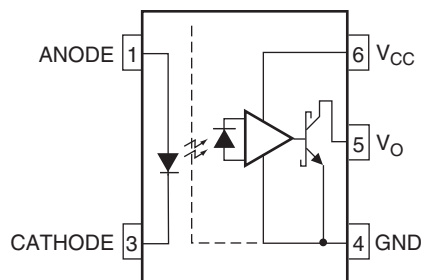

Truth Table

LED	Output
Off	High
On	Low

Pin Definitions

Number	Name	Function Description
1	ANODE	Anode
3	CATHODE	Cathode
4	GND	Output Ground
5	V _O	Output Voltage
6	V _{CC}	Output Supply Voltage

Safety and Insulation Ratings for Mini-Flat Package (SO5 Pin)

As per IEC60747-5-2. This optocoupler is suitable for “safe electrical insulation” only within the safety limit data. Compliance with the safety ratings shall be ensured by means of protective circuits.

Symbol	Parameter	Min.	Typ.	Max.	Unit
	Installation Classifications per DIN VDE 0110/1.89 Table 1				
	For rated main voltage < 150Vrms		I-IV		
	For rated main voltage < 300Vrms		I-III		
	Climatic Classification		40/110/21		
	Pollution Degree (DIN VDE 0110/1.89)		2		
CTI	Comparative Tracking Index	175			
V _{PR}	Input to Output Test Voltage, Method b, V _{IORM} x 1.875 = V _{PR} , 100% Production Test with t _m = 1 sec, Partial Discharge < 5 pC	1060			
V _{PR}	Input to Output Test Voltage, Method a, V _{IORM} x 1.5 = V _{PR} , Type and Sample Test with t _m = 60 sec, Partial Discharge < 5 pC	848			
V _{IORM}	Max Working Insulation Voltage	565			V _{peak}
V _{IOTM}	Highest Allowable Over Voltage	4000			V _{peak}
	External Creepage	5.0			mm
	External Clearance	5.0			mm
	Insulation thickness	0.5			mm
T _{Case}	Safety Limit Values, Maximum Values allowed in the event of a failure, Case Temperature	150			°C
R _{IO}	Insulation Resistance at T _S , V _{IO} = 500V	10 ⁹			Ω

Absolute Maximum Ratings ($T_A=25^\circ\text{C}$ unless otherwise specified)

Stresses exceeding the absolute maximum ratings may damage the device. The device may not function or be operable above the recommended operating conditions and stressing the parts to these levels is not recommended. In addition, extended exposure to stresses above the recommended operating conditions may affect device reliability. The absolute maximum ratings are stress ratings only.

Symbol	Parameter	Value	Units
T_{STG}	Storage Temperature	-40 to +125	$^\circ\text{C}$
T_{OPR}	Operating Temperature	-40 to +110	$^\circ\text{C}$
T_J	Junction Temperature	-40 to +125	$^\circ\text{C}$
T_{SOL}	Lead Solder Temperature (Refer to Reflow Temperature Profile)	260 for 10sec	$^\circ\text{C}$
I_F	Forward Current	50	mA
V_R	Reverse Voltage	5.0	V
V_{CC}	Supply Voltage	0 to 7.0	V
V_O	Output Voltage	-0.5 to $V_{CC}+0.5$	V
I_O	Average Output Current	50	mA
PD_I	Input Power Dissipation ⁽¹⁾⁽²⁾	100	mW
PD_O	Output Power Dissipation ⁽¹⁾⁽²⁾	85	mW

Recommended Operating Conditions

The Recommended Operating Conditions table defines the conditions for actual device operation. Recommended operating conditions are specified to ensure optimal performance to the datasheet specifications. Fairchild does not recommend exceeding them or designing to Absolute Maximum Ratings.

Symbol	Parameter	Min.	Max.	Unit
T_A	Ambient Operating Temperature	-40	+110	$^\circ\text{C}$
V_{CC}, V_{DD}	Supply Voltages ⁽³⁾	3.0	5.5	V
V_{FL}	Logic Low Input Voltage	0	0.8	V
I_{FH}	Logic High Input Current ⁽⁴⁾	6.3	15	mA
I_{FL}	Logic Low Input Current		250	μA
N	Fan Out (at $R_L = 1\text{k}\Omega$)		5	TTL Loads
R_L	Output Pull-up Resistor	330	4k	Ω

Isolation Characteristics ($T_A=25^\circ\text{C}$)

Symbol	Parameter	Test Conditions	Min.	Typ.	Max.	Units
V_{ISO}	Input-Output Isolation Voltage	freq= 60Hz, t = 1.0min, $I_{I-O} \leq 10\mu\text{A}^{(5)(6)}$	3750			$V_{AC_{RMS}}$
R_{ISO}	Isolation Resistance	$V_{I-O} = 500\text{V}^{(5)}$		10^{12}		Ω
C_{ISO}	Isolation Capacitance	$V_{I-O} = 0\text{V}$, freq=1.0MHz ⁽⁵⁾		0.6		pF

Notes:

- No derate required to 110 $^\circ\text{C}$.
- Functional operation under these conditions is not implied. Permanent damage may occur if the device is subjected to conditions outside these ratings.
- 0.1 μF bypass capacitor must be connected between pins 4 and 6.
- Recommended I_{FH} is 9.3mA for operation above $T_A = 100^\circ\text{C}$.
- Device is considered a two terminal device: Pins 1 and 3 are shorted, and Pins 4, 5, and 6 are shorted together.
- 3,750 $V_{AC_{RMS}}$ for 1 minute duration is equivalent to 4,500 $V_{AC_{RMS}}$ for 1 second duration.

Electrical Characteristics (Apply over all recommended conditions)

($T_A = -40^{\circ}\text{C}$ to $+110^{\circ}\text{C}$, $3.0\text{V} \leq V_{CC} \leq 5.5\text{V}$), unless otherwise specified.
 Typical value is measured at $T_A = 25^{\circ}\text{C}$ and $V_{CC} = 3.3\text{V}$.

Symbol	Parameter	Test Conditions	Min.	Typ.	Max.	Units
INPUT CHARACTERISTICS						
V_F	Forward Voltage	$I_F = 10\text{mA}$, Fig. 1	1.05	1.45	1.8	V
BV_R	Input Reverse Breakdown Voltage	$I_R = 10\mu\text{A}$	5.0			V
I_{FHL}	Threshold Input Current	$V_O = 0.6\text{V}$, $I_{OL}(\text{sinking}) = 13\text{mA}$, $T_A < 85^{\circ}\text{C}$, Fig. 2		3.4	5.0	mA
		$T_A = 85^{\circ}\text{C}$ to 110°C		4.2	7.5	
OUTPUT CHARACTERISTICS						
V_{OL}	Logic LOW Output Voltage	$I_F = \text{rated } I_{FHL}$, $I_{OL}(\text{sinking}) = 13\text{mA}$, Fig.3		0.4	0.6	V
I_{OH}	Logic HIGH Output Current	$I_F = 250\mu\text{A}$, $V_O = 3.3\text{V}$, Fig. 4		8.0	50.0	μA
		$I_F = 250\mu\text{A}$, $V_O = 5.0\text{V}$, Fig. 4		2.1	30.0	μA
I_{CCL}	Logic LOW Output Supply Current	$I_F = 10\text{mA}$, $V_{CC} = 3.3\text{V}$, Fig. 5, 7		6.0	8.5	mA
		$I_F = 10\text{mA}$, $V_{CC} = 5.0\text{V}$, Fig. 5, 7		7.5	10.0	
I_{CCH}	Logic HIGH Output Supply Current	$I_F = 0\text{mA}$, $V_{CC} = 3.3\text{V}$, Fig. 6, 7		4.0	7.0	mA
		$I_F = 0\text{mA}$, $V_{CC} = 5.0\text{V}$, Fig. 6, 7		6.0	9.0	

Switching Characteristics (Apply over all recommended conditions)

($T_A = -40^{\circ}\text{C}$ to $+110^{\circ}\text{C}$, $3.0\text{V} \leq V_{CC} \leq 5.5\text{V}$, $I_F = 7.5\text{mA}$), unless otherwise specified.
 Typical value is measured at $T_A = 25^{\circ}\text{C}$ and $V_{CC} = 3.3\text{V}$.

Symbol	Parameter	Test Conditions	Min.	Typ.	Max.	Units
Date Rate		$R_L = 350\Omega$			10	Mbps
t_{PHL}	Propagation Delay Time to Logic Low Output	$R_L = 350\Omega$, $C_L = 15\text{pF}$, Fig. 8 and 11		43	80	ns
t_{PLH}	Propagation Delay Time to Logic High Output	$R_L = 350\Omega$, $C_L = 15\text{pF}$, Fig. 8 and 11		50	80	ns
PWD	Pulse Width Distortion, $ t_{PHL} - t_{PLH} $	$R_L = 350\Omega$, $C_L = 15\text{pF}$, Fig. 9		7	25	ns
t_{PSK}	Propagation Delay Skew	$R_L = 350\Omega$, $C_L = 15\text{pF}^{(7)}$			40	ns
t_R	Output Rise Time, (10% to 90%)	$R_L = 350\Omega$, $C_L = 15\text{pF}$, Fig. 10 and 11		20		ns
t_F	Output Fall Time, (90% to 10%)	$R_L = 350\Omega$, $C_L = 15\text{pF}$, Fig. 10 and 11		10		ns
$ CM_H $	Common Mode Transient Immunity at Output High	$I_F = 0\text{mA}$, $V_O > 0.8 \times V_{CC}$, $V_{CM} = 1000\text{V}^{(8)}$, Fig. 12	20	40		kV/ μs
$ CM_L $	Common Mode Transient Immunity at Output Low	$I_F = 7.5\text{mA}$, $V_O < 0.8\text{V}$, $V_{CM} = 1000\text{V}^{(8)}$, Fig. 12	20	40		kV/ μs

Notes

- t_{PSK} is equal to the magnitude of the worst case difference in t_{PHL} and/or t_{PLH} that will be seen between any two units from the same manufacturing date code that are operated at same case temperature ($\pm 5^{\circ}\text{C}$), at same operating conditions, with equal loads ($R_L = 350\Omega$ and $C_L = 15\text{pF}$), and with an input rise time less than 5ns.
- Common mode transient immunity at output high is the maximum tolerable positive dV_{cm}/dt on the leading edge of the common mode impulse signal, V_{cm} , to assure that the output will remain high. Common mode transient immunity at output low is the maximum tolerable negative dV_{cm}/dt on the trailing edge of the common pulse signal, V_{cm} , to assure that the output will remain low.

Typical Performance Curves

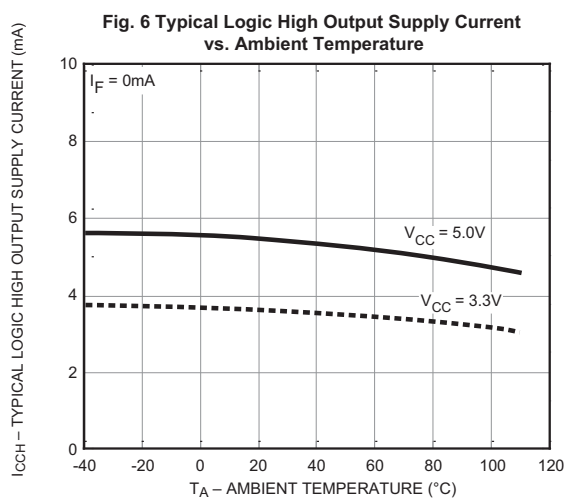
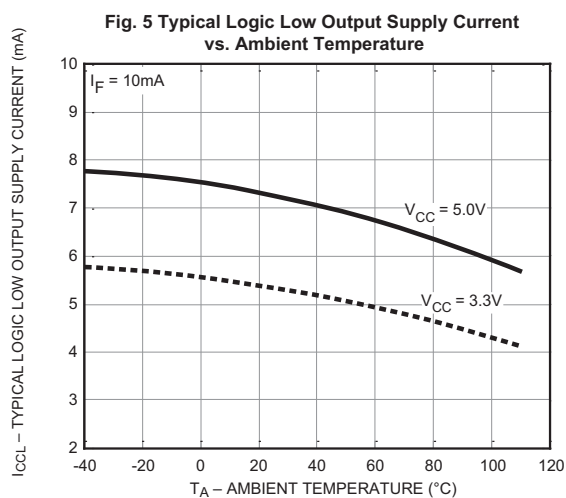
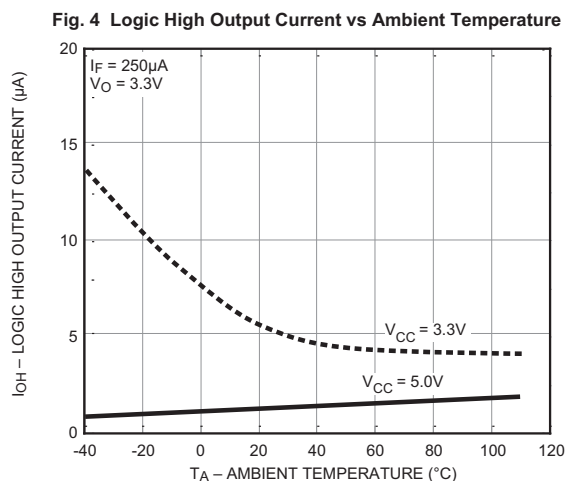
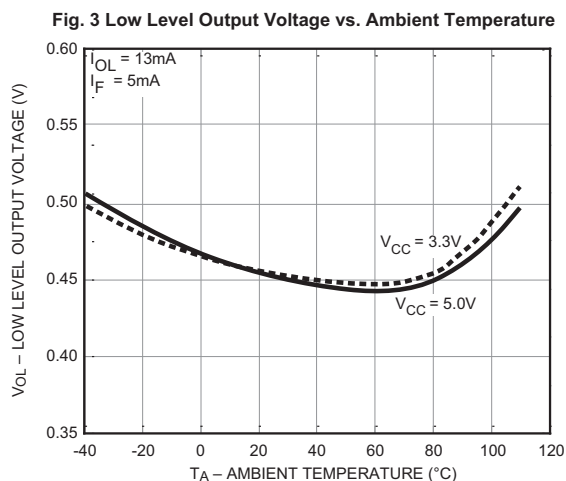
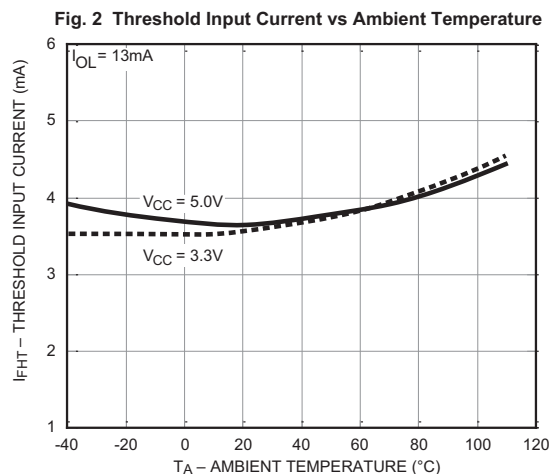
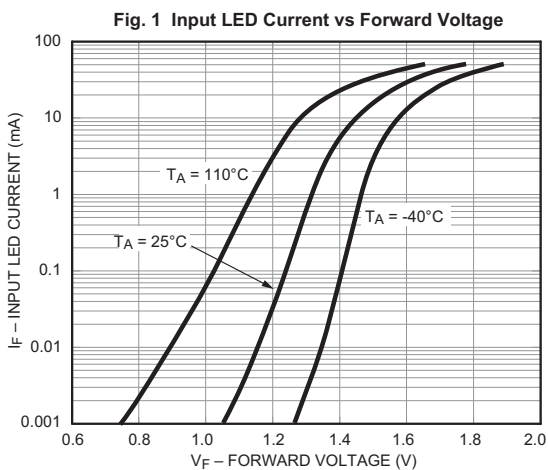

Typical Performance Curves (Continued)

Fig. 7 Typical Logic Output Supply Current vs. Output Supply Voltage

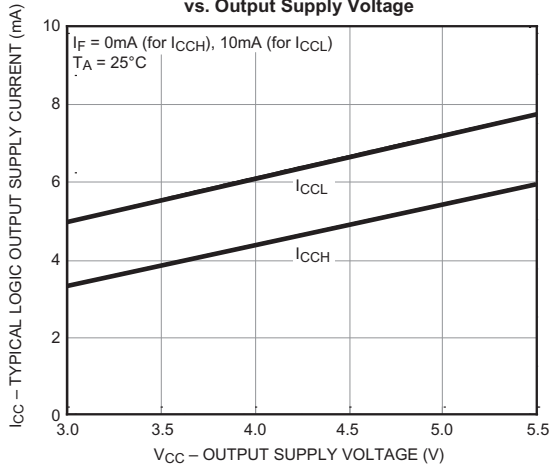

Fig. 8 Typical Propagation Delay vs. Ambient Temperature

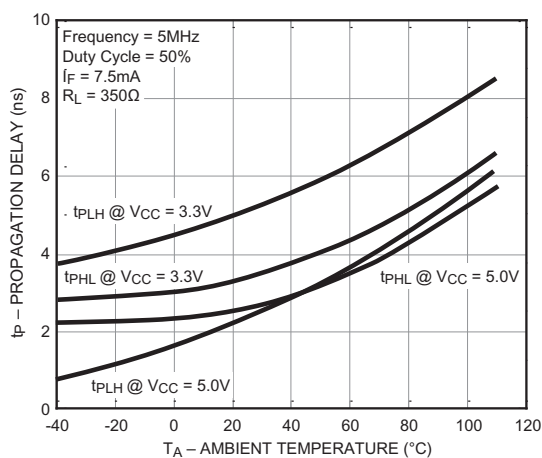

Fig. 9 Typical Pulse Width Distortion vs. Ambient Temperature

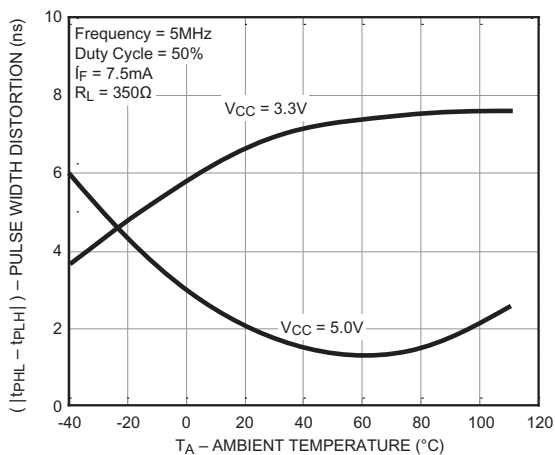
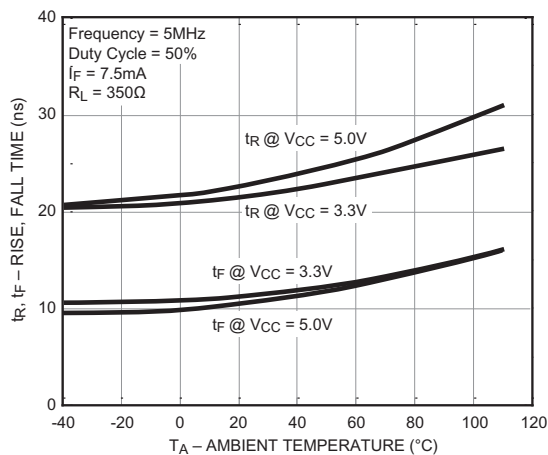

Fig. 10 Typical Rise and Fall Time vs. Ambient Temperature



Schematics

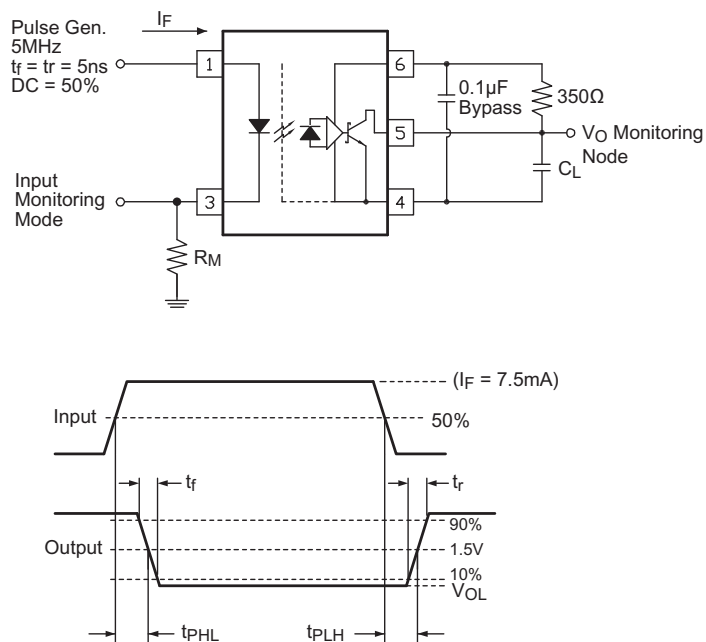

Figure 11. Test Circuit for Propagation Delay Time, Rise Time and Fall Time

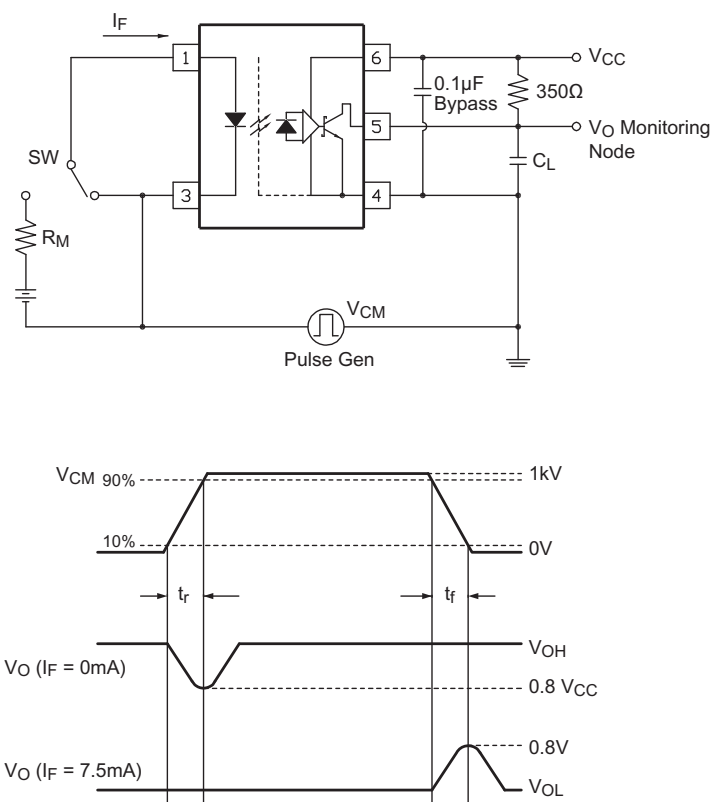
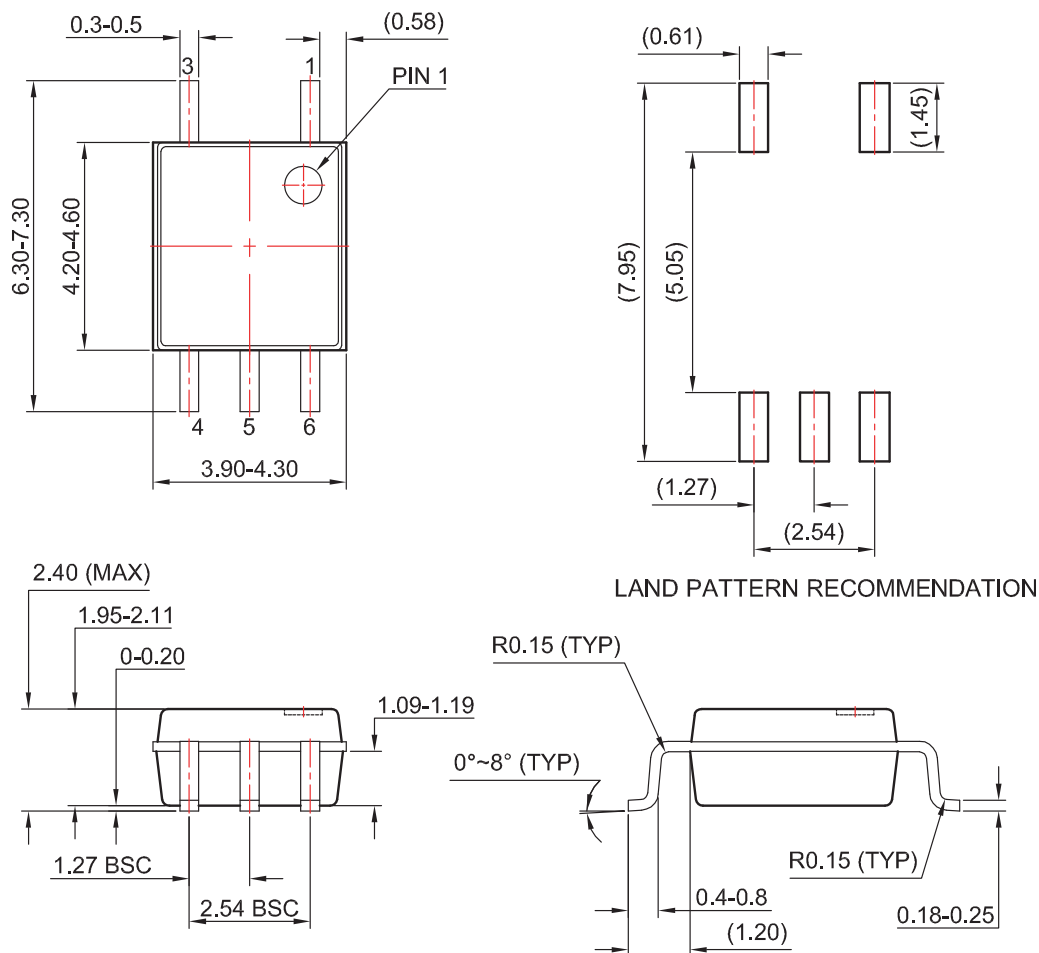

Figure 12. Test Circuit for Instantaneous Common Mode Rejection Voltage

Package Dimensions



Notes:

1. No standard applies to this package.
2. All dimensions are in millimeters.
3. Dimensions are exclusive of burrs, mold flash, and tie bar extrusion.
4. Drawings filename and revision: MKT-MFP05A.

Package drawings are provided as a service to customers considering Fairchild components. Drawings may change in any manner without notice. Please note the revision and/or date on the drawing and contact a Fairchild Semiconductor representative to verify or obtain the most recent revision. Package specifications do not expand the terms of Fairchild's worldwide terms and conditions, specifically the warranty therein, which covers Fairchild products.

Package drawings are provided as a service to customers considering Fairchild components. Drawings may change in any manner without notice. Please note the revision and/or date on the drawing and contact a Fairchild Semiconductor representative to verify or obtain the most recent revision. Package specifications do not expand the terms of Fairchild's worldwide terms and conditions, specifically the warranty therein, which covers Fairchild products.

Always visit Fairchild Semiconductor's online packaging area for the most recent package drawings:

<http://www.fairchildsemi.com/packaging/>

Ordering Information

Part Number	Package	Packing Method
FODM8061	Mini-Flat 5-pin	(100 units per tube)
FODM8061R2	Mini-Flat 5-pin	(2,500 units per Tape and Reel)
FODM8061V	Mini-Flat 5-pin, DIN EN/IEC60747-5-5 Option	(100 units per tube)
FODM8061R2V	Mini-Flat 5-pin, DIN EN/IEC60747-5-5 Option	(2,500 units per Tape and Reel)

 All packages are lead free per JEDEC: J-STD-020B standard.

Marking Information

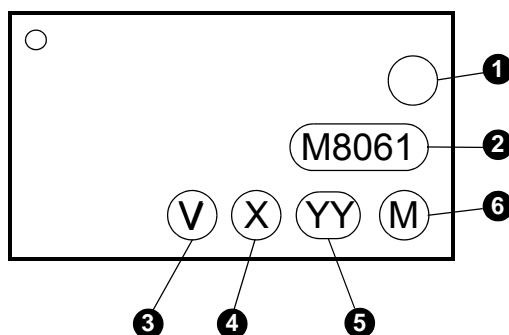

Definitions	
1	ON Semiconductor logo
2	Device number
3	DIN EN/IEC60747-5-5 Option (only appears on components ordered with this option)
4	One digit year code, e.g., '9'
5	Two digit work week ranging from '01' to '53'
6	Assembly package code

Tape and Reel Dimensions

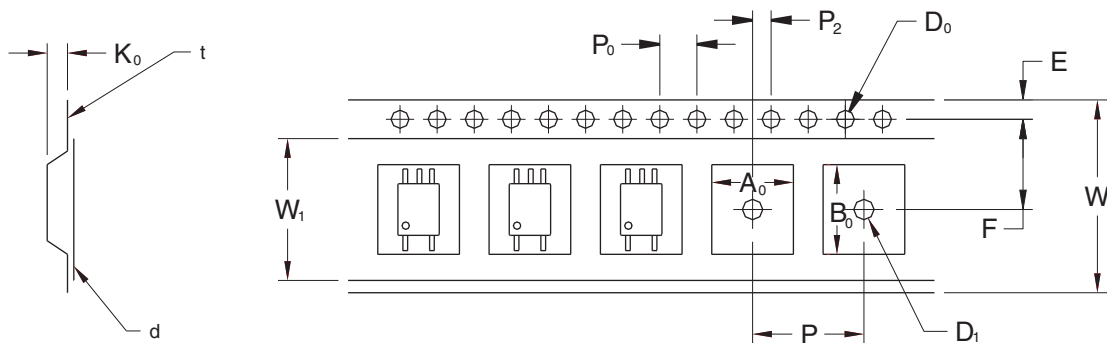

		2.54 Pitch
Description	Symbol	Dimensions (mm)
Tape Width	W	12.00 +0.30/-0.10
Tape Thickness	t	0.30 ±0.05
Sprocket Hole Pitch	P ₀	4.00 ±0.10
Sprocket Hole Diameter	D ₀	1.50 +0.10/-0.0
Sprocket Hole Location	E	1.75 ±0.10
Pocket Location	F	5.50 ±0.10
	P ₂	2.00 ±0.10
Pocket Pitch	P	8.00 ±0.10
Pocket Dimension	A ₀	4.40 ±0.10
	B ₀	7.30 ±0.10
	K ₀	2.30 ±0.10
Pocket Hole Diameter	D ₁	1.50 Min.
Cover Tape Width	W ₁	9.20
Cover Tape Thickness	d	0.065 ±0.010
Max. Component Rotation or Tilt		10° Max.
Devices Per Reel		2500
Reel Diameter		330mm (13")

Reflow Profile

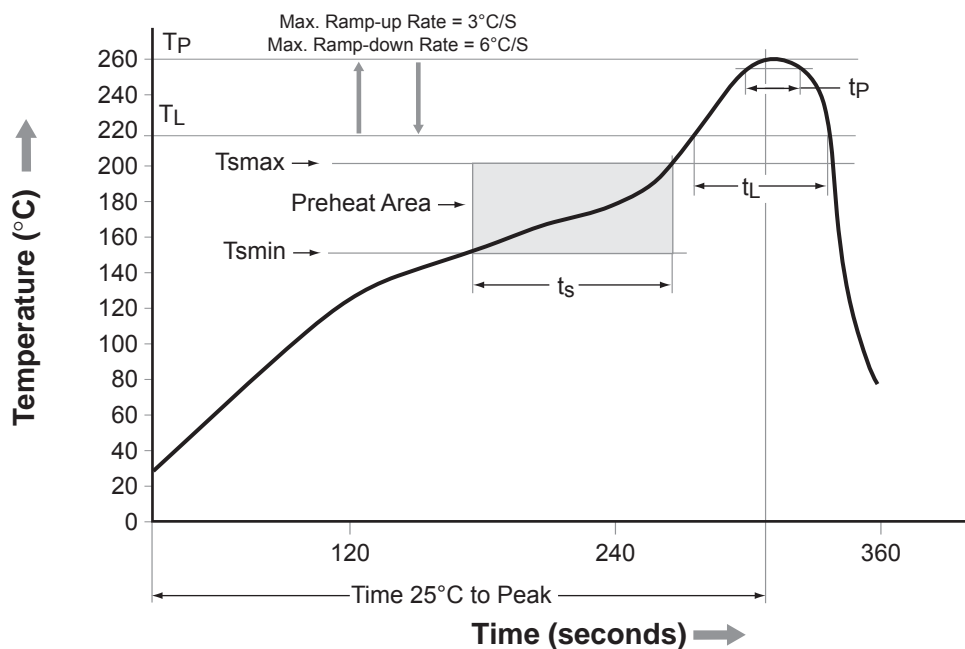

Profile Feature	Pb-Free Assembly Profile
Temperature Min. (Tsmín)	150°C
Temperature Max. (Tsmáx)	200°C
Time (ts) from (Tsmín to Tsmáx)	60–120 seconds
Ramp-up Rate (tL to tp)	3°C/second max.
Liquidous Temperature (TL)	217°C
Time (tL) Maintained Above (TL)	60–150 seconds
Peak Body Package Temperature	260°C +0°C / -5°C
Time (tp) within 5°C of 260°C	30 seconds
Ramp-down Rate (TP to TL)	6°C/second max.
Time 25°C to Peak Temperature	8 minutes max.

ON Semiconductor and  are trademarks of Semiconductor Components Industries, LLC dba ON Semiconductor or its subsidiaries in the United States and/or other countries. ON Semiconductor owns the rights to a number of patents, trademarks, copyrights, trade secrets, and other intellectual property. A listing of ON Semiconductor's product/patent coverage may be accessed at www.onsemi.com/site/pdf/Patent-Marking.pdf. ON Semiconductor reserves the right to make changes without further notice to any products herein. ON Semiconductor makes no warranty, representation or guarantee regarding the suitability of its products for any particular purpose, nor does ON Semiconductor assume any liability arising out of the application or use of any product or circuit, and specifically disclaims any and all liability, including without limitation special, consequential or incidental damages. Buyer is responsible for its products and applications using ON Semiconductor products, including compliance with all laws, regulations and safety requirements or standards, regardless of any support or applications information provided by ON Semiconductor. "Typical" parameters which may be provided in ON Semiconductor data sheets and/or specifications can and do vary in different applications and actual performance may vary over time. All operating parameters, including "Typicals" must be validated for each customer application by customer's technical experts. ON Semiconductor does not convey any license under its patent rights nor the rights of others. ON Semiconductor products are not designed, intended, or authorized for use as a critical component in life support systems or any FDA Class 3 medical devices or medical devices with a same or similar classification in a foreign jurisdiction or any devices intended for implantation in the human body. Should Buyer purchase or use ON Semiconductor products for any such unintended or unauthorized application, Buyer shall indemnify and hold ON Semiconductor and its officers, employees, subsidiaries, affiliates, and distributors harmless against all claims, costs, damages, and expenses, and reasonable attorney fees arising out of, directly or indirectly, any claim of personal injury or death associated with such unintended or unauthorized use, even if such claim alleges that ON Semiconductor was negligent regarding the design or manufacture of the part. ON Semiconductor is an Equal Opportunity/Affirmative Action Employer. This literature is subject to all applicable copyright laws and is not for resale in any manner.

PUBLICATION ORDERING INFORMATION

LITERATURE FULFILLMENT:

Literature Distribution Center for ON Semiconductor
19521 E. 32nd Pkwy, Aurora, Colorado 80011 USA
Phone: 303-675-2175 or 800-344-3860 Toll Free USA/Canada
Fax: 303-675-2176 or 800-344-3867 Toll Free USA/Canada
Email: orderlit@onsemi.com

N. American Technical Support: 800-282-9855 Toll Free
USA/Canada
Europe, Middle East and Africa Technical Support:
Phone: 421 33 790 2910

ON Semiconductor Website: www.onsemi.com

Order Literature: <http://www.onsemi.com/orderlit>

For additional information, please contact your local
Sales Representative

Mouser Electronics

Authorized Distributor

Click to View Pricing, Inventory, Delivery & Lifecycle Information:

[onsemi:](#)

[FODM8061V](#) [FODM8061R2V](#) [FODM8061](#) [FODM8061R2](#)