

20 A - 600 V H-series Snubberless Triac

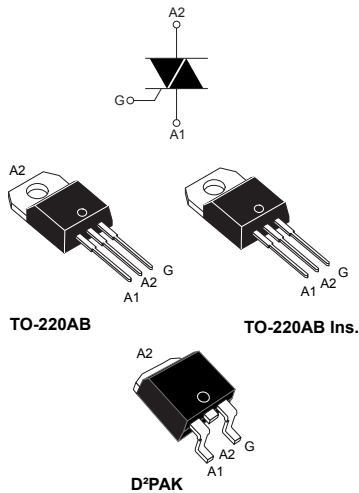

Features

- Medium current Triac
- 150 °C max. T_j turn-off commutation
- Low thermal resistance with clip bonding
- Very high 3 quadrant commutation capabilities
- Packages are RoHS (2002/95/EC) compliant
- UL certified (ref. file E81734)

Applications

Especially designed to operate in high power density or universal motor applications such as vacuum cleaner and washing machine drum motor.

Description

Available in through-hole or surface mount packages, these Triac series are suitable for general purpose mains power ac switching.

These 20 A Triacs provide a very high switching capability up to junction temperatures of 150 °C.

The heatsink can be reduced, compared to traditional Triacs, according to the high performance at given junction temperatures.

By using an internal ceramic pad, they provide voltage insulation (rated at 2500 V_{RMS}).

The surface mount D²PAK package enables compact SMD based designs for automated manufacturing.

Product status link

T2035H-6I, T2035H-6T, T2035H-6G,
T2050H-6I, T2050H-6T, T2050H-6G

Product summary

$I_{T(RMS)}$	20 A
V_{DRM}/V_{RRM}	600 V
I_{GT}	35 or 50 mA

1 Characteristics

Table 1. Absolute maximum ratings (limiting values)

Symbol	Parameter	Value	Unit	
$I_{T(RMS)}$	RMS on-state current (full sine wave)	D ² PAK, TO-220AB $T_c = 128\text{ °C}$	20	A
		TO-220AB Ins. $T_c = 108\text{ °C}$		
I_{TSM}	Non repetitive surge peak on-state current (full cycle, T_j initial = 25 °C)	f = 50 Hz t = 20 ms	200	A
		f = 60 Hz t = 16.7 ms	210	
I^2t	I^2t value for fusing	$t_p = 10\text{ ms}$	265	A ² s
dI/dt	Critical rate of rise of on-state current, $I_G = 2 \times I_{GT}$, tr ≤ 100 ns, f = 100 Hz	f = 120 Hz $T_j = 25\text{ °C}$	100	A/μs
V_{DSM}/V_{RSM}	Non Repetitive peak off-state voltage	$t_p = 10\text{ ms}$ $T_j = 25\text{ °C}$	$V_{DRM}/V_{RRM} + 100$	V
I_{GM}	Peak gate current	$t_p = 20\text{ μs}$ $T_j = 150\text{ °C}$	4	A
$P_{G(AV)}$	Average gate power dissipation	$T_j = 150\text{ °C}$	1	W
T_{stg}	Storage temperature range		-40 to +150	°C
T_j	Operating junction temperature range		-40 to +150	°C

Table 2. Electrical characteristics ($T_j = 25\text{ °C}$, unless otherwise specified)

Symbol	Test conditions	Quadrants		Value		Unit
				T2035H	T2050H	
$I_{GT}^{(1)}$	$V_D = 12\text{ V}$, $R_L = 33\text{ Ω}$	I - II - III	Max.	35	50	mA
V_{GT}			Max.	1.0		
V_{GD}	$V_D = V_{DRM}$, $R_L = 3.3\text{ kΩ}$	I - II - III	Max.	0.15		V
I_L	$I_G = 1.2 \times I_{GT}$	I - III	Max.	50	90	mA
		II	Max.	80	110	
$I_H^{(2)}$	$I_T = 500\text{ mA}$, gate open		Max.	35	75	mA
dV/dt ⁽²⁾	$V_D = 2/3 \times V_{DRM}$, gate open	$T_j = 150\text{ °C}$	Min.	1000	1500	V/μs
(dI/dt) _c ⁽²⁾	Without snubber	$T_j = 150\text{ °C}$	Min.	27	36	A/ms

1. Minimum I_{GT} is guaranteed at 20% of I_{GT} max.

2. For both polarities of A2 referenced to A1.

Table 3. Static characteristics

Symbol	Test conditions		Value	Unit
V_T ⁽¹⁾	$I_T = 28 \text{ A}$, $t_p = 380 \mu\text{s}$	$T_j = 25 \text{ }^\circ\text{C}$	Max. 1.5	V
V_{TO} ⁽¹⁾	Threshold voltage	$T_j = 150 \text{ }^\circ\text{C}$	Max. 0.80	V
R_D ⁽¹⁾	Dynamic resistance	$T_j = 150 \text{ }^\circ\text{C}$	Max. 19	m Ω
I_{DRM}/I_{RRM}	$V_D = V_R = 600 \text{ V}$	$T_j = 25 \text{ }^\circ\text{C}$	Max. 5	μA
		$T_j = 150 \text{ }^\circ\text{C}$		6.2
	$V_D = V_R = 400 \text{ V}$, peak voltage	$T_j = 150 \text{ }^\circ\text{C}$	Max. 5.0	mA
		$T_j = 150 \text{ }^\circ\text{C}$		

1. For both polarities of A2 referenced to A1.
2. $t_p = 380 \mu\text{s}$

Table 4. Thermal resistance

Symbol	Parameter		Value	Unit
$R_{th(j-c)}$	Junction to case (AC)	D ² PAK, TO-220AB	1.0	$^\circ\text{C/W}$
		TO-220AB Ins.	1.9	
$R_{th(j-a)}$	Junction to ambient ($S_{cu} = 2 \text{ cm}^2$)	D ² PAK, TO-220AB	45	$^\circ\text{C/W}$
		TO-220AB Ins.	60	

1.1 Characteristics (curves)

Figure 1. Maximum power dissipation versus on-state RMS current

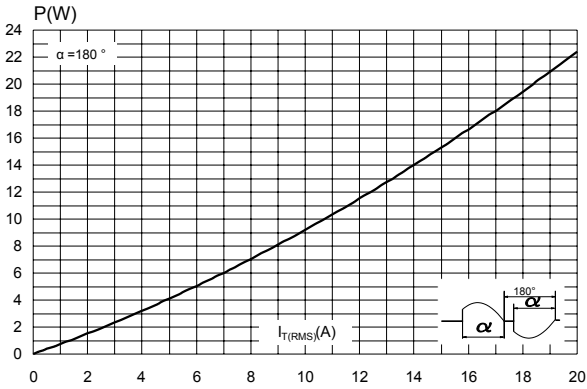

Figure 2. On-state RMS current versus case temperature

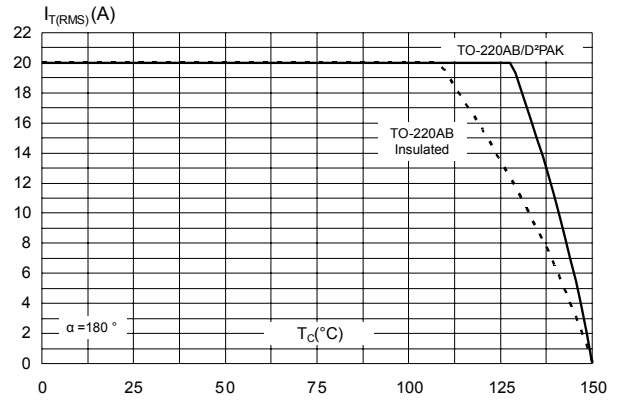

Figure 3. On-state RMS current versus ambient temperature

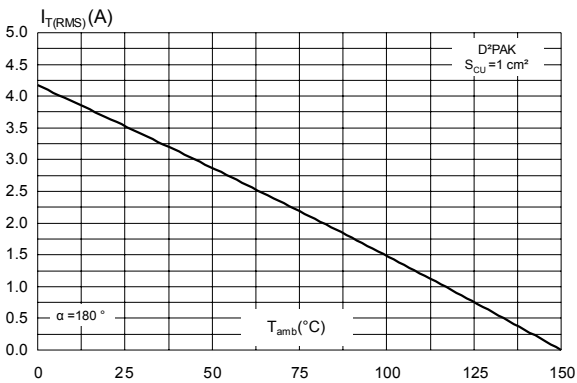

Figure 4. Variation of thermal impedance versus pulse duration

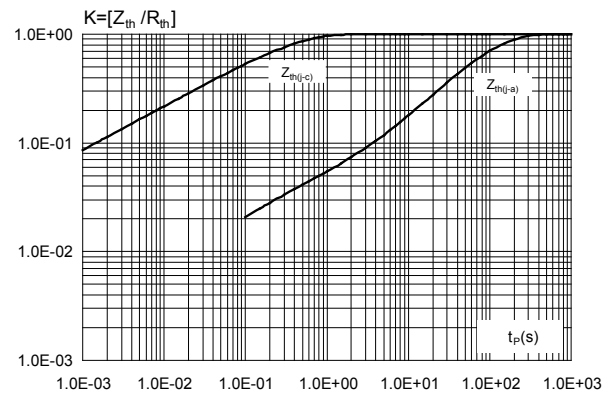

Figure 5. On-state characteristics (maximum values)

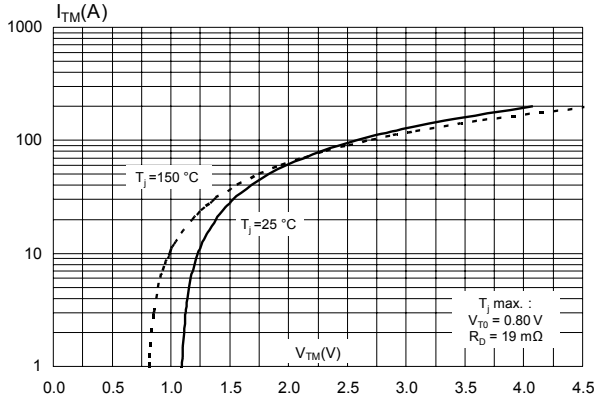

Figure 6. Surge peak on-state current versus number of cycles

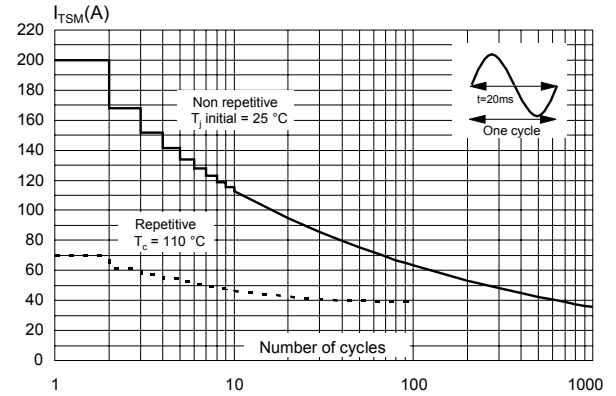

Figure 7. Non-repetitive surge peak on-state current for a sinusoidal pulse

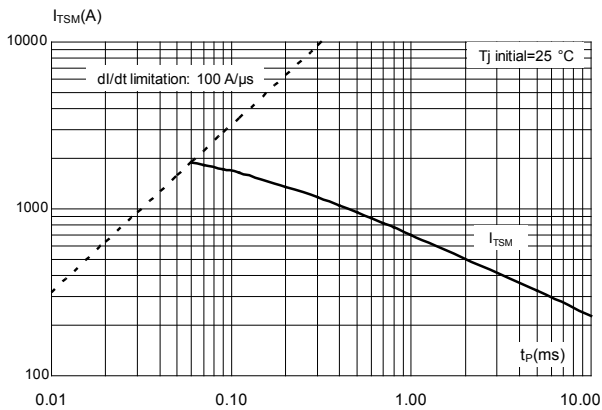

Figure 8. Relative variation of I_{GT}, I_H, I_L vs junction temperature (typical values)

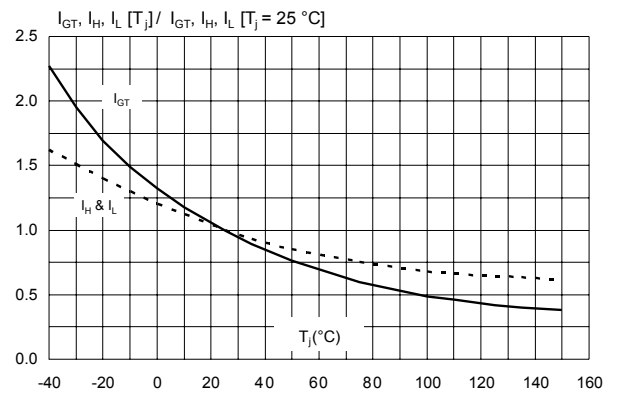

Figure 9. Relative variation of critical rate of decrease of main current $(di/dt)_c$ versus reapplied $(dV/dt)_c$

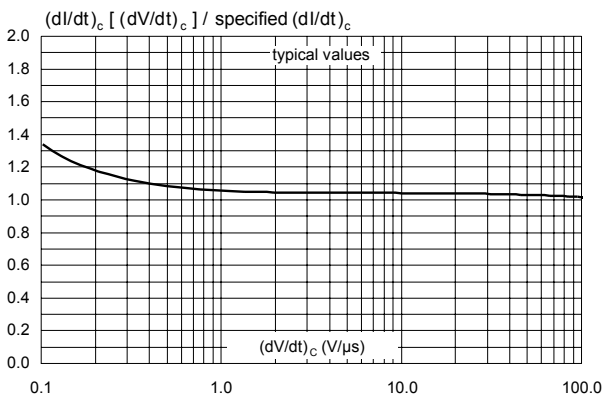

Figure 10. Relative variation of critical rate of decrease of main current versus junction temperature

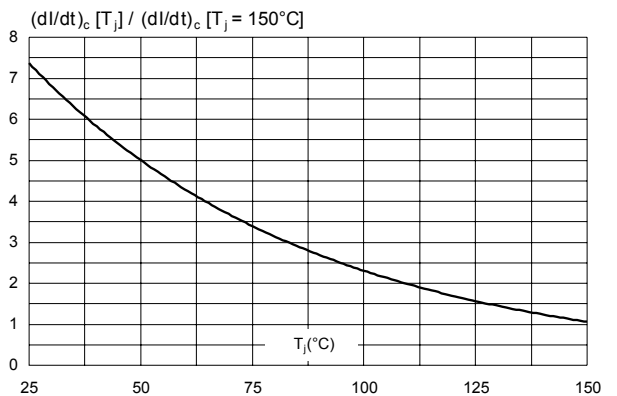

Figure 11. Leakage current versus junction temperature for different values of blocking voltage (typical values)

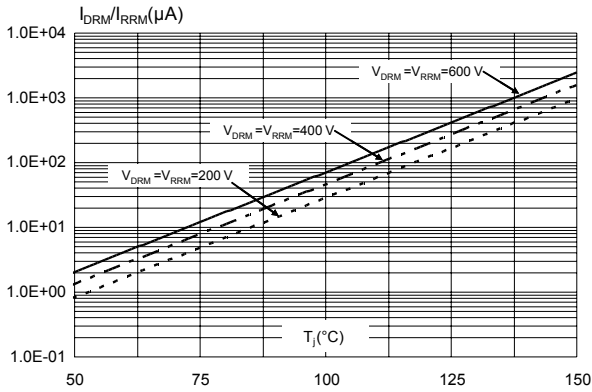

Figure 12. Acceptable repetitive peak off-state voltage versus case to ambient thermal resistance

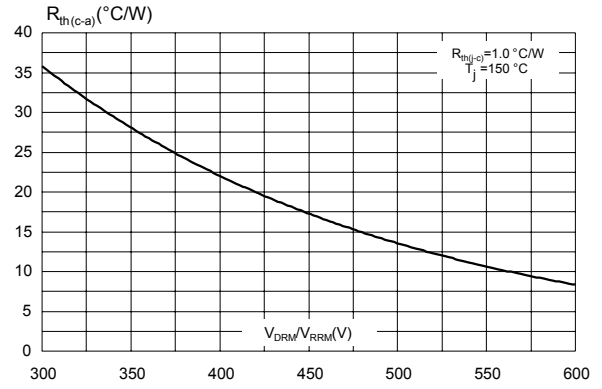
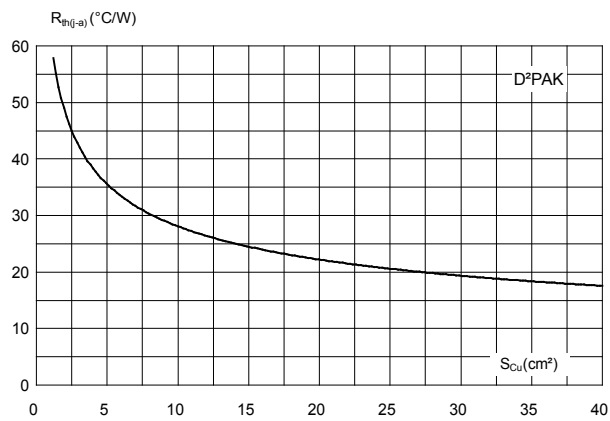

Figure 13. Thermal resistance junction to ambient versus copper surface under tab



2 Package information

In order to meet environmental requirements, ST offers these devices in different grades of **ECOPACK** packages, depending on their level of environmental compliance. ECOPACK specifications, grade definitions and product status are available at: www.st.com. ECOPACK is an ST trademark.

2.1 D²PAK package information

Figure 14. D²PAK package outline

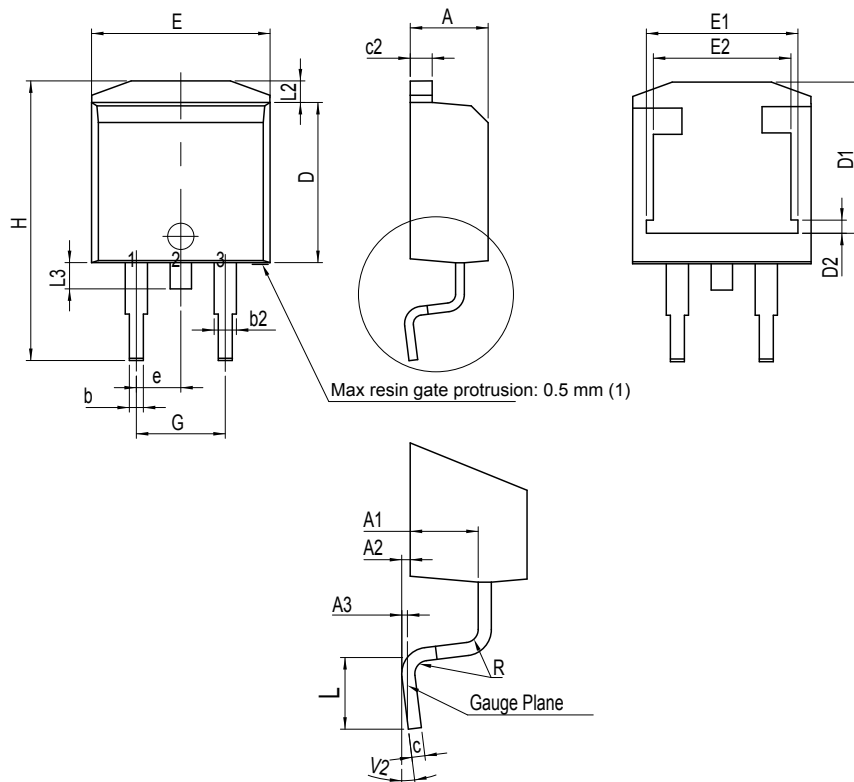

(1) Resin gate is accepted in each of position shown on the drawing, or their symmetrical.

Table 5. D²PAK package mechanical data

Ref.	Dimensions					
	Millimeters			Inches ⁽¹⁾		
	Min.	Typ.	Max.	Min.	Typ.	Max.
A	4.30		4.60	0.1693		0.1811
A1	2.49		2.69	0.0980		0.1059
A2	0.03		0.23	0.0012		0.0091
A3		0.25			0.0098	
b	0.70		0.93	0.0276		0.0366
b2	1.25		1.7	0.0492		0.0669
c	0.45		0.60	0.0177		0.0236
c2	1.21		1.36	0.0476		0.0535
D	8.95		9.35	0.3524		0.3681
D1	7.50		8.00	0.2953		0.3150
D2	1.30		1.70	0.0512		0.0669
e	2.54			0.1		
E	10.00		10.28	0.3937		0.4047
E1	8.30		8.70	0.3268		0.3425
E2	6.85		7.25	0.2697		0.2854
G	4.88		5.28	0.1921		0.2079
H	15		15.85	0.5906		0.6240
L	1.78		2.28	0.0701		0.0898
L2	1.27		1.40	0.0500		0.0551
L3	1.40		1.75	0.0551		0.0689
R		0.40			0.0157	
V2	0°		8°	0°		8°

1. Dimensions in inches are given for reference only

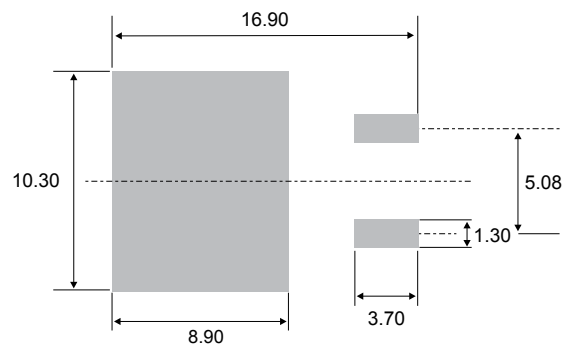
Figure 15. D²PAK recommended footprint (dimensions are in mm)

2.2 TO-220AB package information

- Molding compound resin is halogen-free and meets flammability standard UL94 level 0
- Lead-free package leads finishing
- [ECOPACK2](#) compliant
- Recommended torque: 0.4 to 0.6 N.m

Figure 16. TO-220AB package outline

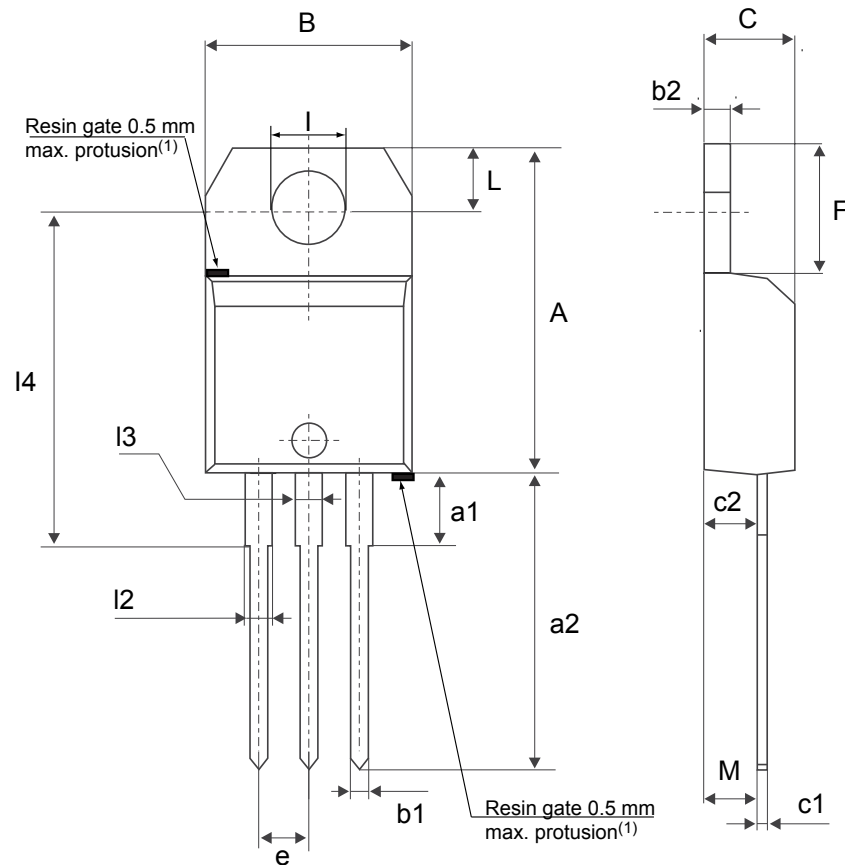

(1) Resin gate position accepted in one of the two positions or in the symmetrical opposites.

Table 6. TO-220AB package mechanical data

Ref.	Dimensions					
	Millimeters			Inches ⁽¹⁾		
	Min.	Typ.	Max.	Min.	Typ.	Max.
A	15.20		15.90	0.5984		0.6260
a1		3.75			0.1476	
a2	13.00		14.00	0.5118		0.5512
B	10.00		10.40	0.3937		0.4094
b1	0.61		0.88	0.0240		0.0346
b2	1.23		1.32	0.0484		0.0520
C	4.40		4.60	0.1732		0.1811
c1	0.49		0.70	0.0193		0.0276
c2	2.40		2.72	0.0945		0.1071
e	2.40		2.70	0.0945		0.1063
F	6.20		6.60	0.2441		0.2598
I	3.73		3.88	0.1469		0.1528
L	2.65		2.95	0.1043		0.1161
I2	1.14		1.70	0.0449		0.0669
I3	1.14		1.70	0.0449		0.0669
I4	15.80	16.40	16.80	0.6220	0.6457	0.6614
M		2.6			0.1024	

1. Inch dimensions are for reference only.

3 Ordering information

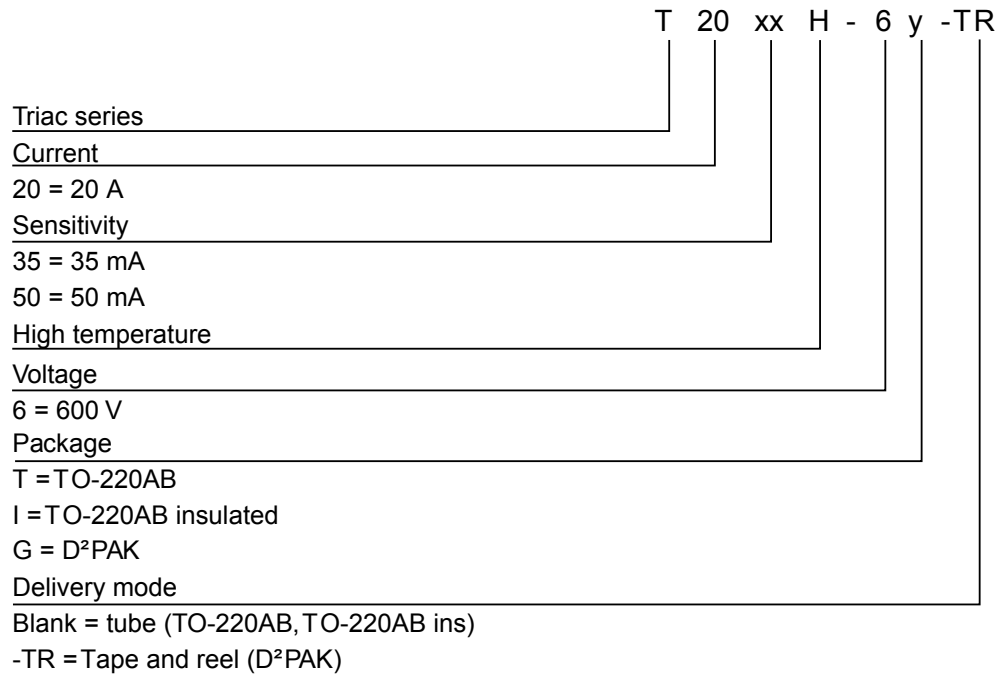
Figure 17. Ordering information scheme

Table 7. Ordering information

Order code	Marking	Package	Weight	Base qty.	Delivery mode
T2035H-6G	T2035H-6G	D ² PAK	1.5 g	50	Tube
T2035H-6G-TR	T2035H-6G			1000	Tape and reel 13"
T2035H-6I	T2035H-6I	TO-220AB Ins.	2.3 g	50	Tube
T2035H-6T	T2035H-6T	TO-220AB	2.3 g	50	Tube
T2050H-6G	T2050H-6G	D ² PAK	1.5 g	50	Tube
T2050H-6G-TR	T2050H-6G			1000	Tape and reel 13"
T2050H-6T	T2050H-6T	TO-220AB	2.3 g	50	Tube

Revision history

Table 8. Document revision history

Date	Version	Changes
31-May-2007	1	First issue.
19-Sep-2011	2	Added TO-220AB Ins and D ² PAK packages. Reformatted to current standards.
08-Aug-2011	3	Updated: Features and Description. Removed order code T20xxH-6G from Figure 14 and Table 8.
05-Jan-2017	4	Updated Figure 4: "Variation of thermal impedance versus pulse duration" , Figure 7: "Non-repetitive surge peak on-state current for a sinusoidal pulse", Section 6.2: "D ² PAK package information", Section 6.3: "TO-220AB (NIns. and Ins.) package information" and Table 8: "Ordering information".
02-Oct-2019	5	Updated description title. Minor text changed.
06-Aug-2021	6	Updated Table 2 .



IMPORTANT NOTICE – PLEASE READ CAREFULLY

STMicroelectronics NV and its subsidiaries (“ST”) reserve the right to make changes, corrections, enhancements, modifications, and improvements to ST products and/or to this document at any time without notice. Purchasers should obtain the latest relevant information on ST products before placing orders. ST products are sold pursuant to ST’s terms and conditions of sale in place at the time of order acknowledgement.

Purchasers are solely responsible for the choice, selection, and use of ST products and ST assumes no liability for application assistance or the design of Purchasers’ products.

No license, express or implied, to any intellectual property right is granted by ST herein.

Resale of ST products with provisions different from the information set forth herein shall void any warranty granted by ST for such product.

ST and the ST logo are trademarks of ST. For additional information about ST trademarks, please refer to www.st.com/trademarks. All other product or service names are the property of their respective owners.

Information in this document supersedes and replaces information previously supplied in any prior versions of this document.

© 2021 STMicroelectronics – All rights reserved

Mouser Electronics

Authorized Distributor

Click to View Pricing, Inventory, Delivery & Lifecycle Information:

[STMicroelectronics:](#)

[T2035H-6T](#) [T2035H-6I](#) [T2035H-6G-TR](#) [T2035H-6G](#)