

40 V, 1 A power Schottky rectifier

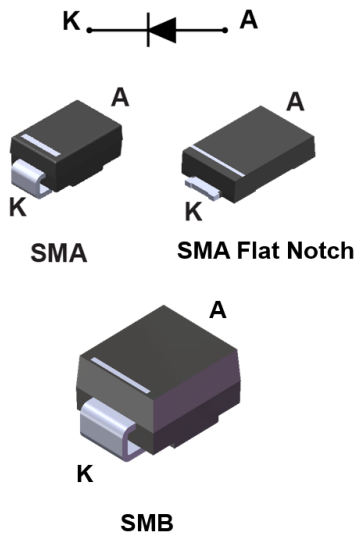

Features

- Very small conduction losses
- Negligible switching losses
- Low forward voltage drop
- Surface mount miniature packages
- Avalanche rated
- [ECOPACK2](#) compliant

Applications

- Reverse polarity protection
- Set-top box power supply
- TV power supply
- Battery charger

Description

Single chip Schottky rectifiers suited to switched mode power supplies and high frequency DC to DC converters.

Packaged in SMA, SMA Flat Notch and SMB, the [STPS140](#) is ideal for use in surface mounting and used in low voltage, high frequency inverters, free-wheeling and polarity protection applications.

Product status	
STPS140	
Product summary	
Symbol	Value
$I_{F(AV)}$	1 A
V_{RRM}	40 V
$T_{j(max.)}$	150 °C
$V_{F(typ.)}$	0.43 V

1 Characteristics

Table 1. Absolute ratings (limiting values at 25 °C, unless otherwise specified)

Symbol	Parameter		Value	Unit	
V_{RRM}	Repetitive peak reverse voltage		40	V	
$I_{F(RMS)}$	Forward rms current		7	A	
$I_{F(AV)}$	Average forward current $\delta = 0.5$, square wave	SMA	$T_L = 130\text{ °C}$	1	A
		SMA Flat Notch	$T_L = 135\text{ °C}$		
		SMB	$T_L = 135\text{ °C}$		
I_{FSM}	Surge non repetitive forward current		$t_p = 10\text{ ms}$ sinusoidal	60	A
P_{ARM}	Repetitive peak avalanche power		$t_p = 10\text{ }\mu\text{s}$, $T_j = 125\text{ °C}$	65	W
T_{stg}	Storage temperature range		-65 to +150	°C	
T_j	Operating junction temperature ⁽¹⁾		+150	°C	

1. $(dP_{tot}/dT_j) < (1/R_{th(j-a)})$ condition to avoid thermal runaway for a diode on its own heatsink.

Table 2. Thermal resistance parameter

Symbol	Parameter		Max. value	Unit
$R_{th(j-l)}$	Junction to lead	SMA	30	°C/W
		SMA Flat Notch	20	
		SMB	25	

For more information, please refer to the following application note :

- AN5088 : Rectifiers thermal management, handling and mounting recommendations

Table 3. Static electrical characteristics

Symbol	Parameter	Test conditions		Min.	Typ.	Max.	Unit
$I_R^{(1)}$	Reverse leakage current	$T_j = 25\text{ °C}$	$V_R = V_{RRM}$	-		12	μA
		$T_j = 100\text{ °C}$		-	0.25	2	mA
$V_F^{(2)}$	Forward voltage drop	$T_j = 25\text{ °C}$	$I_F = 1\text{ A}$	-		0.55	V
		$T_j = 125\text{ °C}$		-	0.43		
		$T_j = 25\text{ °C}$	$I_F = 2\text{ A}$	-		0.65	
		$T_j = 125\text{ °C}$		-	0.53	0.60	

1. Pulse test: $t_p = 5\text{ ms}$, $\delta < 2\%$

2. Pulse test: $t_p = 380\text{ }\mu\text{s}$, $\delta < 2\%$

To evaluate the conduction losses, use the following equation:

$$P = 0.40 \times I_{F(AV)} + 0.10 \times I_{F(RMS)}^2$$

For more information, please refer to the following application notes related to the power losses :

- AN604: Calculation of conduction losses in a power rectifier
- AN4021: Calculation of reverse losses on a power diode

1.1 Characteristics (curves)

Figure 1. Average forward power dissipation versus average forward current

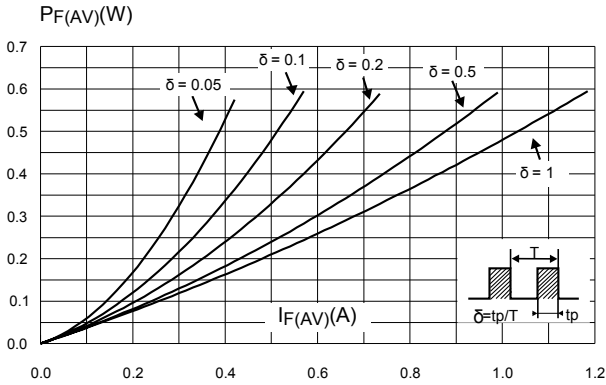

Figure 2. Average forward current versus ambient temperature (SMA, $\delta = 0.5$)

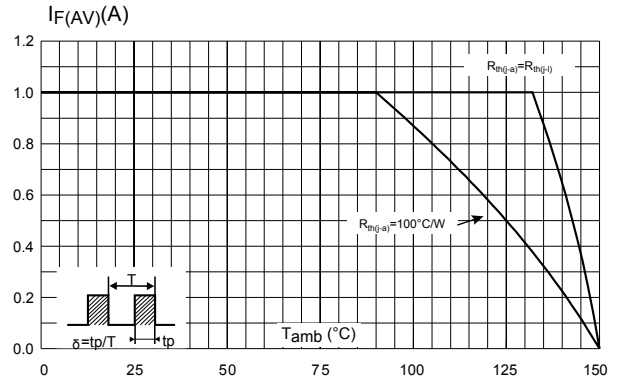

Figure 3. Average forward current versus ambient temperature (SMB, $\delta = 0.5$)

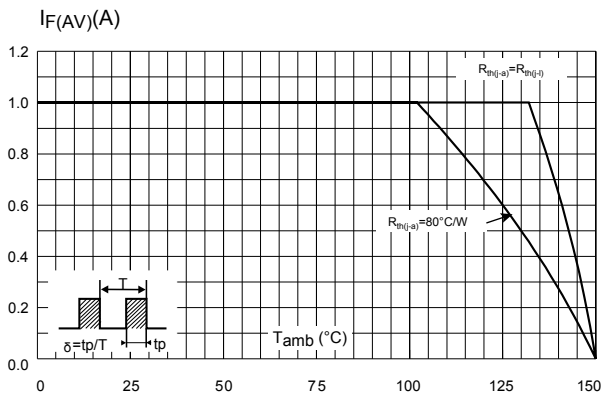

Figure 4. Normalized avalanche power derating versus pulse duration ($T_j = 125$ °C)

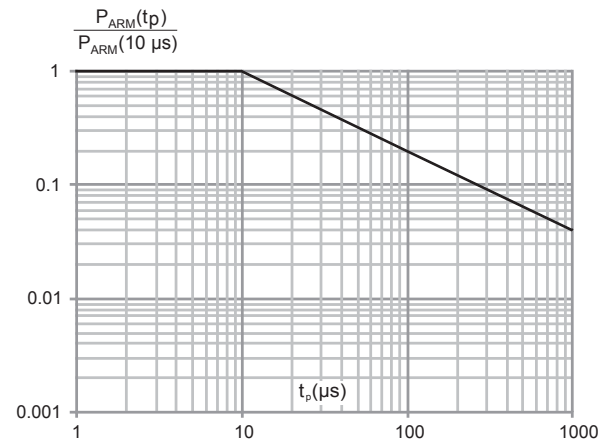

Figure 5. Relative variation of thermal impedance junction to ambient versus pulse duration (SMA)

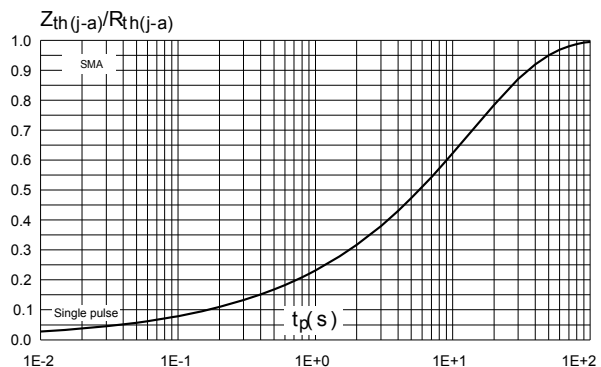

Figure 6. Relative variation of thermal impedance junction to ambient versus pulse duration (SMB)

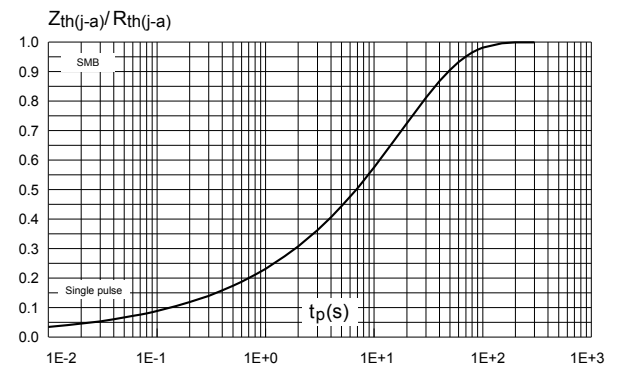

Figure 7. Reverse leakage current versus reverse voltage applied (typical values)

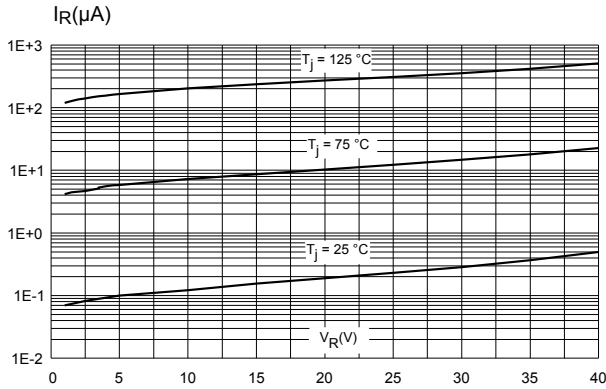

Figure 8. Junction capacitance versus reverse voltage applied (typical values)

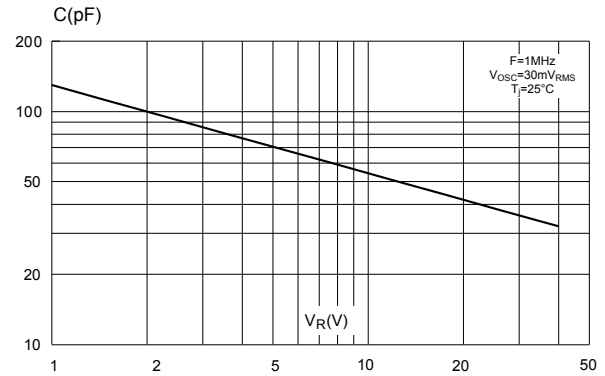

Figure 9. Forward voltage drop versus forward current (maximum values)

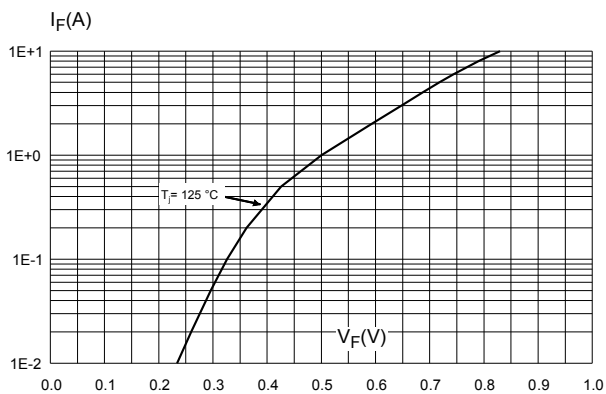

Figure 10. Thermal resistance junction to ambient versus copper surface under each lead (typical values)

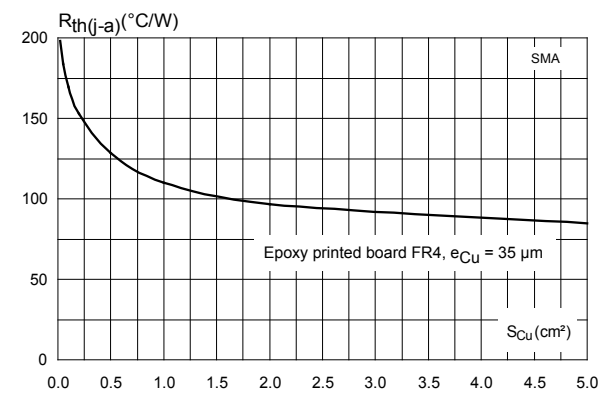

Figure 11. Thermal resistance junction to ambient versus copper surface under each lead (typical values)

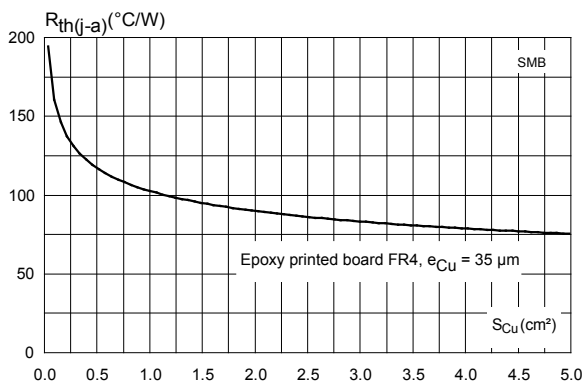
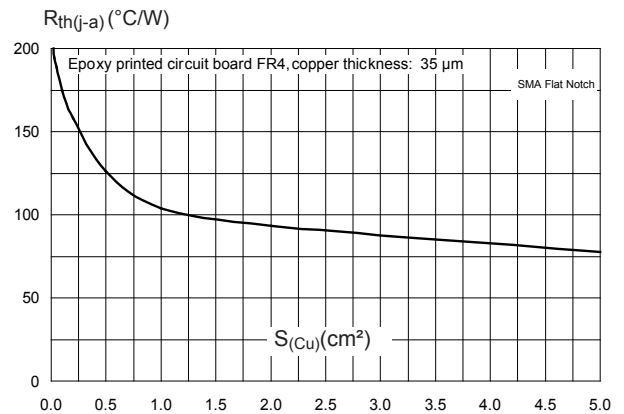

Figure 12. Thermal resistance junction to ambient versus copper surface under each lead (SMA Flat Notch)



2 Package information

In order to meet environmental requirements, ST offers these devices in different grades of **ECOPACK** packages, depending on their level of environmental compliance. ECOPACK specifications, grade definitions and product status are available at: www.st.com. ECOPACK is an ST trademark.

2.1 SMA package information

- Epoxy meets UL94, V0
- Cooling method : by conduction (C)

Figure 13. SMA package outline

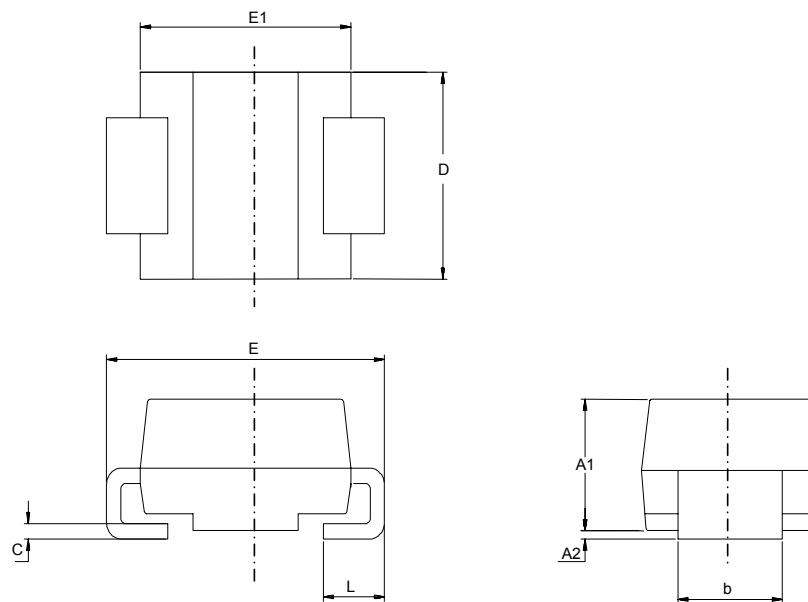
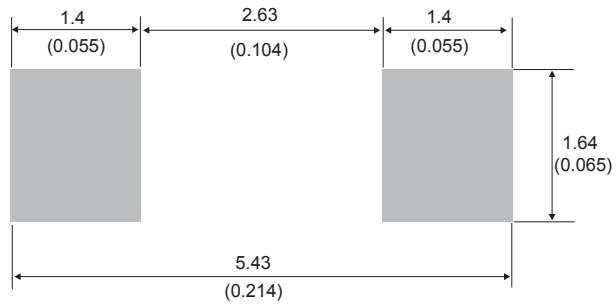

Table 4. SMA package mechanical data

Ref.	Dimensions			
	Millimeters		Inches (for reference only)	
	Min.	Max.	Min.	Max.
A1	1.90	2.45	0.074	0.097
A2	0.05	0.20	0.001	0.008
b	1.25	1.65	0.049	0.065
c	0.15	0.40	0.005	0.016
D	2.25	2.90	0.088	0.115
E	4.80	5.35	0.188	0.211
E1	3.95	4.60	0.155	0.182
L	0.75	1.50	0.029	0.060

Figure 14. SMA recommended footprint in mm (inches)



2.2 SMA Flat Notch package information

- Epoxy meets UL94, V0
- Cooling method: by conduction (C)
- Band indicates cathode

Figure 15. SMA Flat Notch package outline

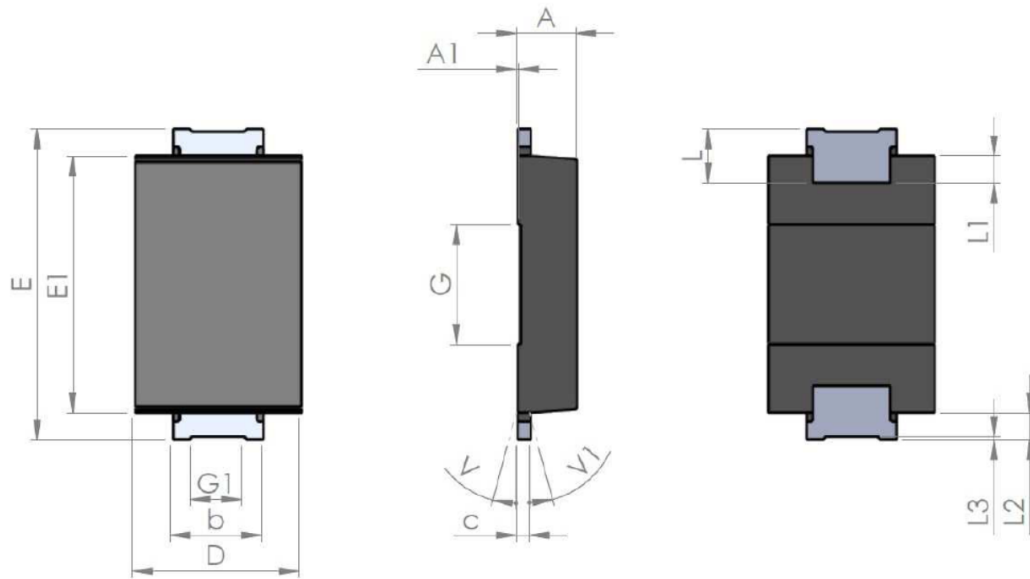
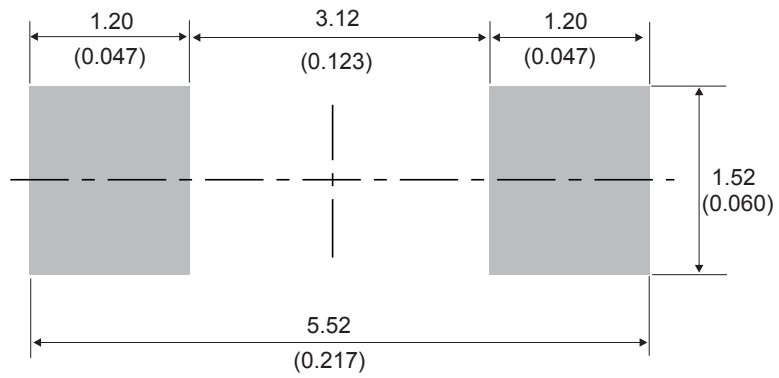

Table 5. SMA Flat Notch package mechanical data

Ref.	Dimensions					
	Millimeters			Inches (for reference only)		
	Min.	Typ.	Max.	Min.	Typ.	Max.
A1	0.90		1.10	0.035		0.044
A1		0.05			0.002	
b	1.25		1.65	0.049		0.065
C	0.15		0.40	0.005		0.016
D	2.25		2.90	0.088		0.115
E	5.00		5.35	0.196		0.211
E1	3.95		4.60	0.155		0.182
G		2.00			0.079	
G1		0.85			0.033	
L	0.75		1.20	0.029		
L1		0.45			0.018	
L2		0.45			0.018	
L3		0.05			0.002	
V			8°			8°
V1			8°			8°

Figure 16. SMA Flat Notch recommended footprint in mm (inches)



2.3 SMB package information

- Epoxy meets UL94, V0
- Lead-free package

Figure 17. SMB package outline

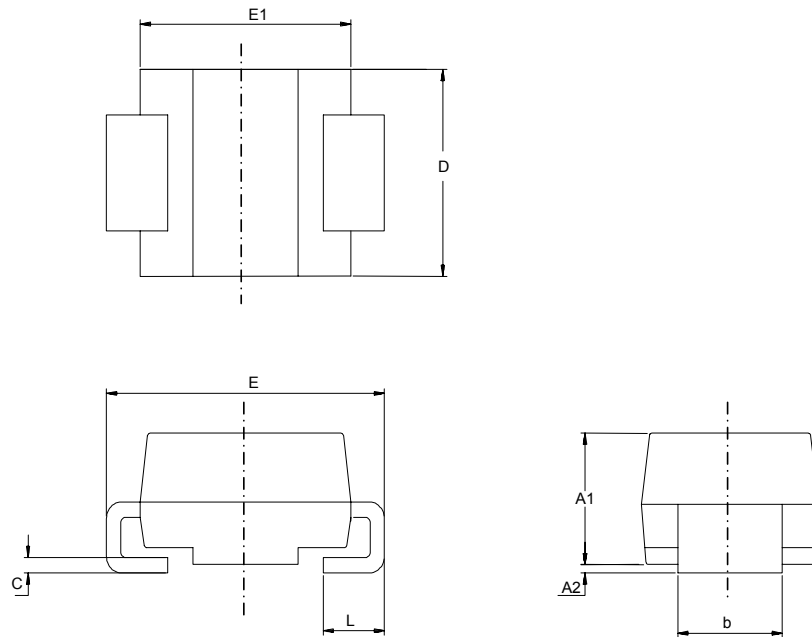
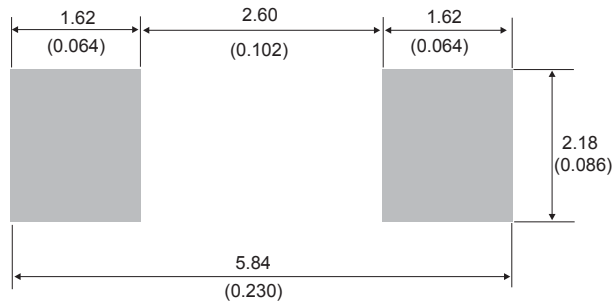

Table 6. SMB package mechanical data

Ref.	Dimensions			
	Millimeters		Inches (for reference only)	
	Min.	Max.	Min.	Max.
A1	1.90	2.45	0.074	0.097
A2	0.05	0.20	0.001	0.008
b	1.95	2.20	0.076	0.087
c	0.15	0.40	0.005	0.016
D	3.30	3.95	0.129	0.156
E	5.10	5.60	0.200	0.221
E1	4.05	4.60	0.159	0.182
L	0.75	1.50	0.029	0.060

Figure 18. SMB recommended footprint



3 Ordering information

Table 7. Ordering information

Order code	Marking	Package	Weight	Base qty.	Delivery mode
STPS140A	S140	SMA	68 mg	5000	Tape and reel
STPS140AFN	A140	SMA Flat Notch	39 mg	10 000	Tape and reel
STPS140U	G14	SMB	107 mg	2500	Tape and reel

Revision history

Table 8. Document revision history

Date	Revision	Changes
Jul-2003	7.2	Last update.
Aug-2004	7.3	SMA package dimensions update. Reference A1 max. changed from 2.70 mm (0.106 inch.) to 2.03 mm (0.080).
25-Nov-2018	8	Updated Table 1. Absolute ratings (limiting values at 25 °C, unless otherwise specified) , Figure 4. Normalized avalanche power derating versus pulse duration (T_j = 125 °C) , Section 2.3 and Section 2.1 .
27-Sep-2019	9	Added Section 2.2 SMA Flat Notch package information .

IMPORTANT NOTICE – PLEASE READ CAREFULLY

STMicroelectronics NV and its subsidiaries (“ST”) reserve the right to make changes, corrections, enhancements, modifications, and improvements to ST products and/or to this document at any time without notice. Purchasers should obtain the latest relevant information on ST products before placing orders. ST products are sold pursuant to ST’s terms and conditions of sale in place at the time of order acknowledgement.

Purchasers are solely responsible for the choice, selection, and use of ST products and ST assumes no liability for application assistance or the design of Purchasers’ products.

No license, express or implied, to any intellectual property right is granted by ST herein.

Resale of ST products with provisions different from the information set forth herein shall void any warranty granted by ST for such product.

ST and the ST logo are trademarks of ST. For additional information about ST trademarks, please refer to www.st.com/trademarks. All other product or service names are the property of their respective owners.

Information in this document supersedes and replaces information previously supplied in any prior versions of this document.

© 2019 STMicroelectronics – All rights reserved

Mouser Electronics

Authorized Distributor

Click to View Pricing, Inventory, Delivery & Lifecycle Information:

[STMicroelectronics:](#)

[STPS140A](#) [STPS140U](#) [STPS140AFN](#)