

<b>numatics</b>	INSTALLATION AND MAINTENANCE INSTRUCTIONS	EN
	INSTRUCTIONS D'INSTALLATION ET DE MAINTENANCE	FR
	INBETRIEBNAHME - UND WARTUNGSANLEITUNG	DE
	INSTRUCCIONES DE PUESTA EN MARCHA Y MANTENIMIENTO	ES
	ISTRUZIONI DI MESSA IN SERVIZIO E MANUTENZIONE	IT
	ALGEMENE INSTALLATIE- EN ONDERHOUDSINSTRUCTIES	NL
	INSTALLASJONS- OG VEDLIKEHOLDSINSTRUKSER	NO
	INSTALLATIONS- OCH UNDERHÅLLSINSTRUKTIONER	SE
	ASENNUS - JA HUOLTO-OHJEET	FI
	INSTALLATIONS - OG VEDLIGEHOLDSANVISNINGER	DK
	INSTRUÇÕES DE INSTALAÇÃO E MANUTENÇÃO	PT
	ΟΔΗΓΙΕΣ ΤΟΠΟΘΕΤΗΣΗΣ ΚΑΙ ΣΥΝΤΗΡΗΣΗΣ	GR
	POKRYTY PRO INSTALACI A ÚDRŽBU	CZ
INSTRUKCJA MONTAŻU I KONSERWACJI	PL	
TELEPÍTÉSI ÉS KARBANTARTÁSI ÚTMUTATÓ	HU	
Инструкция по установке и обслуживанию	RU	
설치 및유지 관리 지침	KR	

# 494

ILS MR

MR

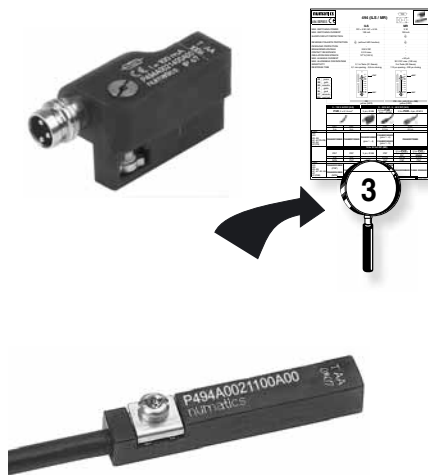

504425-001 / A Availability, design and specifications are subject to change without notice. All rights reserved.

**numatics**

494 SERIES

## 494 (ILS / MR)

	ILS	MR
MAX. SWITCHING POWER	DC = 5 W / AC = 5 VA	3 W
MAX. SWITCHING CURRENT	100 mA	100 mA
SHORT-CIRCUIT PROTECTION	-	
REVERSE POLARITY PROTECTION	(without LED function)	
OVERLOAD PROTECTION	-	-
BREAKDOWN VOLTAGE	230 V DC	-
CONTACT RESISTANCE	0,2 Ω max.	-
INSULATION RESISTANCE	10 <sup>8</sup> Ω (100 V)	-
MAX. LEAKAGE CURRENT	-	< 50 µA
MAX. ALLOWABLE OVERVOLTAGE	-	32 V DC max. (100 ms)
SENSITIVITY	2,1 m Tesla (21 Gauss)	2 m Tesla (20 Gauss)
RESPONSE TIME	0,1 ms opening - 0,6 ms closing	110 µs opening - 220 µs closing

CE  
yellow (LED)

CE - UL - cUL (2 m + M8)  
yellow (LED)

Series	5 .. 120 V AC/DC (ILS)		5 .. 50 V AC - 5 .. 60 V DC (ILS)			
	PUR, 2 x 0,14 mm <sup>2</sup>	3 pin, Ø M8	0,3 m PUR + 3-pin, Ø M8	0,3 m PUR + 3-pin, Ø M12		
449 453 435 - 438 441 - 447 (P2L-P2B) 450 - 454 437 (PCN)	P494A0021300A00	P494A0021100A00	P494A0021400A00 (pins 1 - 4)	P494A0021500A00 (pins 1 - 4)	P494A0021600A00 (pins 1 - 3)	P494A0021700A00
	<b>10 to 30 Volt DC (MR)</b>					
	IP67	IP67	3 pin, Ø M8	IP67	0,3 m PUR + 3-pin, Ø M12	0,3 m PVC + 3-pin, Ø M12
	2 m	5 m	-	0,3 m	IP67 0,3 m	IP69K 0,3 m
	NPN	PNP	PNP	PNP	PNP	PNP
Series	P494A0022300A00 (PNP)		P494A0022500A00	P494A0022600A00 (PNP)	P494A0022800A00	P494A0022900A00
449 453 435 - 438 441 - 447 - 450 - 454 437 431 (IP69K)	P494A0022400A00 (NPN)	P494A0022100A00	P494A0022500A00	P494A0022700A00 (NPN)	P494A0022800A00	P494A0022900A00

**numatics**

494 SERIES

**ILS**

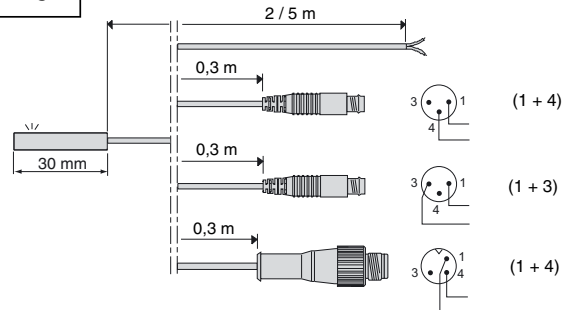

	br (+)	blu (-)
GB	brown	blue
FR	marron	bleu
DE	braun	blau
ES	marrón	azul
IT	marrone	blu
NL	bruin	blauw
PT	castanho	azul
RU	коричневый	синий

For inductive loads (valves, contactors, ...), external protection is required to avoid damage caused by switch-off voltage peaks.

Use freewheeling diode, transistor diode, varistor or similar.

Detectors used for direct control of incandescent lamps:  
The capacity specified on the lamp is based on its resistance when hot. When switched on, the resistance of the cold lamp is very low. Therefore, the current rises quickly and may exceed the rated switch rating. Allowance should therefore be made for the real power of the cold lamp.

With leads longer than 10 m, a 200 Ω resistor must be fitted in series with the detector to reduce the capacitive effect caused by the wiring.

EN

FR

DE

ES

IT

NL

PT

RU

Les détecteurs utilisés avec charge inductive (électrovannes, relais,...) nécessitent une protection (diode de roue libre, diode transistor, varistor,...) pour éviter la dégradation des contacts par des surtensions.

Détecteurs utilisés en commande directe d'ampoules à incandescence : la puissance indiquée sur l'ampoule tient compte de la résistance lorsque celle-ci est chaude. Lors de la mise sous tension, ampoule froide, la résistance étant très faible, l'intensité devient très importante et peut dépasser les performances de l'ILS. Il convient donc de tenir compte de la puissance réelle de l'ampoule à l'état froid.

Longueurs de câbles supérieures à 10 m : prévoir en plus une résistance de 200 Ω à placer en série au plus proche du détecteur afin de réduire les effets capacitifs dus à la ligne.

Bei Anschluss einer induktiven Last (Ventile, Relais, usw.) ist eine Schutzdiode zu legen (Freilaufdiode, Transilodiode, Varistor usw.) um eine Beschädigung der Kontakte aufgrund von Überspannungen zu vermeiden.

Direkt befähigter Näherungsschalter mit Reed-Kontakt: Die auf der Diode angegebene Leistung bezieht sich auf den Widerstand, wenn diese warm wird. Beim Einschalten ist der Widerstand der kalten Diode sehr gering, der Strom steigt sehr schnell an und kann die Leistung des Reed-Kontakts übersteigen. Es ist daher empfehlenswert, die tatsächliche Leistung der kalten Diode zu berücksichtigen.

Bei einem Kabelschwanz länger als 10 m ist ein zusätzlicher Widerstand von 200 Ω in Reihe mit dem Näherungsschalter vorzusehen, um die Kapazität, die sich aus der Leitungslänge ergibt, zu reduzieren.

Los detectores utilizados con carga inductiva (electroválvulas, relés,...) necesitan una protección (diodo de supresión, diodo transistor, varistor,...) para evitar la degradación de los contactos por sobretensiones.

Detectores utilizados en el pilotaje directo de interruptores de incandescencia: La potencia indicada en la lámpara tiene en cuenta la resistencia cuando ésta está caliente. Sin embargo, cuando se pone bajo tensión, la lámpara está fría y por tanto la resistencia es muy baja, por lo que la intensidad puede superar las características del ILE. Por ello hay que tener en cuenta la potencia real de la lámpara en estado frío.

Longitudes de cable superiores a 10 m: prever además una resistencia de 200 Ω a situar en serie lo más cerca posible del detector con el fin de reducir los efectos capacitivos debidos a la línea.

I fincorsa utilizzati con carico induttivo (elettrovalvole, relais,...) richiedono una protezione (diodo di ricircolo, diodo transistor, varistore,...) per evitare l'usura dei contatti causato da sovratensioni.

Fincorsa utilizzati per il comando diretto di lampade ad incandescenza: la potenza indicata tiene conto della resistenza quando la lampada è calda. Al momento della messa in tensione, la lampada fredda, la resistenza è molto bassa, per cui l'intensità può aumentare rapidamente e superare i limiti di prestazione dei fincorsa REED. Si consiglia quindi di tenere conto della potenza reale della lampada a freddo.

Con i cavi di lunghezza superiore a 10 m: prevede una resistenza da 200 Ω da collegare in serie con il fincorsa per ridurre gli effetti capacitivi causati dal cablaggio.

Voor inductieve ladingen (kleppen, contactschakelaars, ...) is externe beveiliging vereist om schade te voorkomen die wordt veroorzaakt door spanningspieken bij uitschakeling. Gebruik vrijlopende diode, transistor diode, varistor of dergelijke.

Detectores die worden gebruikt voor directe bediening van gloeilampen: Het vermogen dat op de lamp vermeld staat, is gebaseerd op de weerstand wanneer deze warm is. Ingeschakeld is de weerstand van de koude lamp zeer laag. Daarom stijgt de stroom snel en kan deze het vermogen van de reedschakelaar overtreffen. Daarom moet compensatie plaatsvinden voor het werkelijke vermogen van de koude lamp.

Bij snoeren die langer zijn dan 10 m, moet een 200 Ω resistor in serie worden gemonteerd op de detector om het capacitief effect te beperken dat wordt veroorzaakt door de bedrading.

Os detetores utilizados com carga inductiva (eletroválvulas, relés,...) necessitam de uma proteção (diodo de supressão, diodo transistor, varistor,...) para evitar a degradação dos contatos devido a sobretensões.

Detetores utilizados para o comando direto de LED's incandescentes: a capacidade especificada na LED é baseada na resistência quando este está quente. Quando colocada sob tensão, a resistência do LED frio é muito baixa. Assim sendo, a corrente sobe rapidamente e poderá exceder os desempenhos do interruptor ILS. É importante ter em conta a potência real do interruptor em estado frio.

Comprimento de cabos superior a 10 metros: prever também uma resistência de 200 Ω a colocar em série o mais próximo possível do detetor, com a finalidade de reduzir os efeitos capacitivos causados pela cablagem.

Для индуктивной нагрузки (клапаны, контакторы, ...) требуется внешняя защита во избежание повреждений от перенапряжения при отключении оборудования.

Используйте диод свободного хода, переходный диод, варистор или подобные элементы.

Датчик, используемый для непосредственного контроля ламп накаливания.

Емкость, указанная на лампе, рассчитана, исходя из ее сопротивления в нагретом состоянии. Во включенном состоянии сопротивление холодной лампы очень низкое. Следовательно сила тока возрастет быстро и может превысить значение для срабатывания герконового реле. Поэтому следует сделать поправку для активной мощности холодной лампы.

На отрезке, превышающем длину 10 м, резистор с сопротивлением 200 Ом должен быть подключен последовательно с датчиком, чтобы снизить влияние емкостного сопротивления проводки.

**numatics**

494 SERIES

**MR**

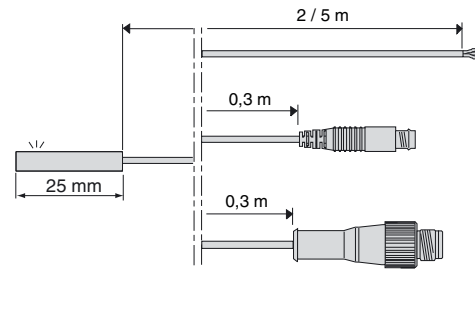

	br (+)	blu (-)	blk (load)
GB	brown	blue	black
FR	marron	bleu	noir
DE	braun	blau	schwarz
ES	marrón	azul	negro
IT	marrone	blu	nero
NL	bruin	blauw	zwart
PT	castanho	azul	preto
RU	коричневый	синий	черный

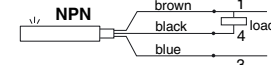
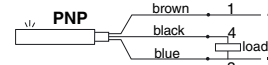
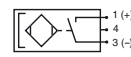

EN

FR

DE

ES

IT

NL

PT

RU

Do not subject the detector's power supply cable to damaging traction / torsion during its service life.

Output protected against short-circuit as long as the output current is restricted to 0.1 A.

Improper wire connection may prevent the detector from operating or even destroy it.

It is recommended to install a protection diode (mounted in parallel) on an inductive load in spite of the internal protection.

S'assurer que le câble électrique d'alimentation du détecteur n'est pas soumis à des tractions / torsions néfastes à sa durée de vie.

Sortie protégée contre les courts-circuits éventuels de la charge lorsque le courant de sortie est inférieur ou égal à 0,1 A.

Le branchement incorrect des fils de sortie peut entraîner le non fonctionnement ou la destruction du mini-détecteur.

Malgré la protection interne, dans le cas de charge selfique, il est recommandé d'utiliser une diode (montée en parallèle) sur la charge.

Achten Sie darauf, dass das Spannungsversorgungskabel des Näherungsschalters während der gesamten Lebensdauer ohne Zugbelastung verlegt und nicht verdreht wird.

Der Ausgang ist gegen Kurzschluss geschützt, solange der Ausgangsstrom auf 0,1 A beschränkt wird.

Unschlagmäßiger elektrischer Anschluss verursacht eine Fehlfunktion des Näherungsschalters oder kann diesen zerstören.

Trotz des internen Schutzes ist bei Anschluss einer induktiven Last eine Schutzdiode parallel zur induktiven Last zu legen.

Comprobar que el cable eléctrico de alimentación del detector no está sometido a tracciones / torsiones nefastas para su duración.

Salida protegida contra los corto-circuitos eventuales de la carga cuando la corriente de salida es inferior o igual a 0,1 A.

La conexión incorrecta de los hilos de salida puede provocar el no funcionamiento o la destrucción del mini-detecter.

A pesar de la protección interna, en el caso de carga selfica, se recomienda utilizar un diodo (montado en paralelo) en la carga.

Assicurarsi che il cavo elettrico d'alimentazione del fincorsa non sia sottoposto a trazioni / torsioni dannose al ciclo di vita.

Uscita protetta contro eventuali cortocircuiti di carico se la tensione d'uscita è inferiore o uguale a 0,1 A.

L'errato collegamento dei fili può causare il mancato funzionamento o la distruzione del fincorsa.

Si raccomanda di installare un diodo (montato in parallelo) o un carico induttivo nonostante la protezione interna.

Stel de stroomkabel van de detector niet bloot aan beschadigende tractie/torsie tijdens de levensduur.

Aansluiting beveiligd tegen kortsluiting zolang de uitgangsstroom is beperkt tot 0,1 A.

Een onjuiste draadaansluiting kan ertoe leiden dat de detector niet werkt of zelfs vernietigd wordt.

Aanbevolen wordt een beveiligingsdiode te installeren (parallel gemonteerd) op een inductieve lading ondanks de interne beveiliging.

Assegurar que o cabo elétrico de alimentação do detetor não está sujeito a trações/torsões prejudiciais à sua vida útil.

Saída protegida contra os eventuais curto-circuitos da carga quando a corrente de saída é inferior ou igual a 0,1 A.

A ligação incorreta dos fios de saída pode impedir o não funcionamento ou a destruição do mini-detector.

Apesar da proteção interna, no caso de carga selfica, é recomendado utilizar um diodo (montado em paralelo) na carga.

Кабель питания датчика не должен сильно натягиваться или перекручиваться на протяжении всего срока службы.

Выход защищен от коротких замыканий, если сила тока на выходе ограничена значением 0,1 А.

Неправильное подключение проводов может помешать работе датчика или даже уничтожить его.

Вместо внутренней защиты рекомендуется установить защитный диод (подключается параллельно) для индуктивной нагрузки.



Polarities to be observed

Respecter les polarités

Bitte Polarität beachten

Respetar las polaridades

Rispettare la polarità

Polariteiten die in acht genomen moeten worden

Polarities to be observed

Polarities to be observed

Polarities to be observed

**numatics**

494 SERIES

# ACCESSORIES (ILS / MR)

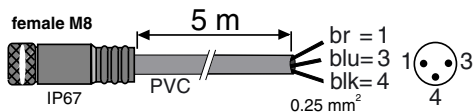

P4994406200N001

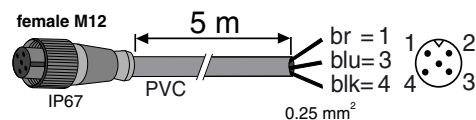

P4994406210N001



P4994406220N001



P4994406230N001

P4994406160N001

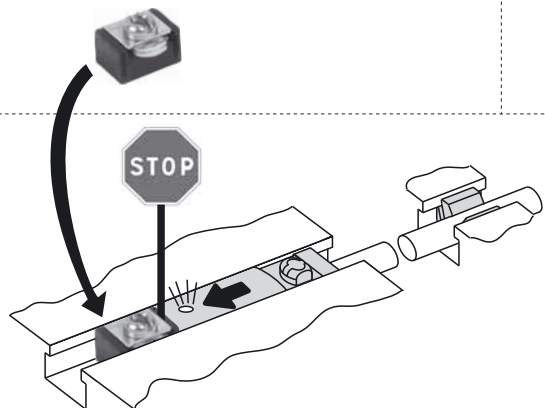

	br	blu	blk
GB	brown	blue	black
FR	marron	bleu	noir
DE	braun	blau	schwarz
ES	marrón	azul	negro
IT	marrone	blu	nero
NL	bruin	blauw	zwart
PT	castanho	azul	preto
RU	коричневый	синий	черный

**numatics**

494 SERIES

# MOUNTING ("T" GROOVE CYLINDERS)

«T» GROOVE (Series: 441 / 449 / 450 / 453)

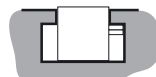

441



Ø 32 .. 100 mm

449



453



454



P494A0029100A00

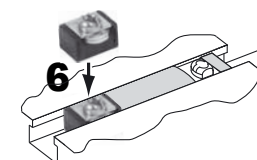
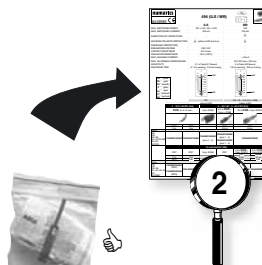
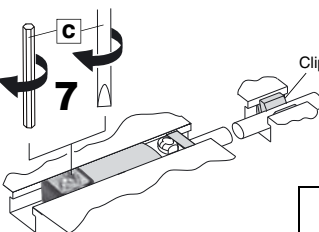
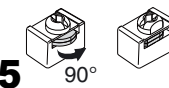
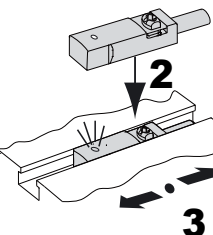
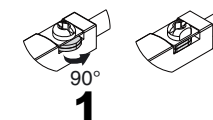

items	N.m	Inch.pounds
C	0,5	4,41

**numatics**

494 SERIES

# MOUNTING (ROUND CYLINDERS + 436)

Series: 431 / 435 / 438 + 436

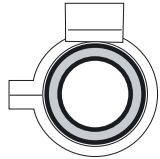

items:	N.m	Inch.pounds
C	0,5	4,41
D	0,4	3,5

series	∅ (mm)	plastic	AISI 303 + 304
8-10		-	P494AG129600A00
12		P494AJ129300A00	P494AK129600A00
16		P494AK129300A00	P494AK129600A00
20		P494AL129300A00	P494AL129600A00
25		P494AM129300A00	P494AL129600A00
32		P494A3129300A00	P494A3129600A00
40		P494A4129300A00	P494A4129600A00
50		-	P494A5129600A00
63		-	P494A6129600A00
80		-	P494A8129600A00
436	250	-	P494AS129200A00

∅ 12 → 40 mm

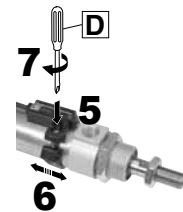

∅ 8 → 80 mm

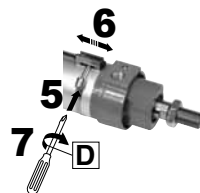
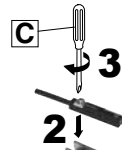

**numatics**

494 SERIES

# MOUNTING (TIE ROD CYLINDERS)

Series: 450 / 437

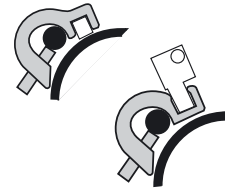

series	∅ (mm)	plastic	AISI 303 + 304
437	25	P494AM129200A00	P499440617MN001
450	32-40	P494A3129200A00	P4994406183N001
437	50-63-80	P494A5129200A00	
	100	P494A8129200A00	
	125	P494AP129200A00	
	160-200	P494AP129200A00	

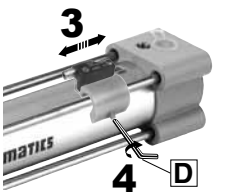
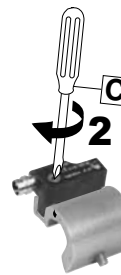
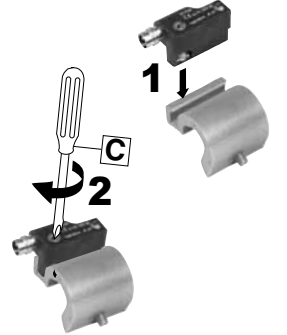
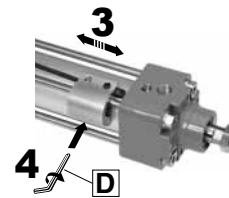
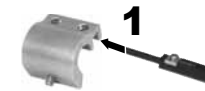

items:	N.m	Inch.pounds
C	0,5	4,41
D	0,4	3,5

**numatics**

494 SERIES

**MOUNTING**

Series: 449 / 447 (P2L-P2B)

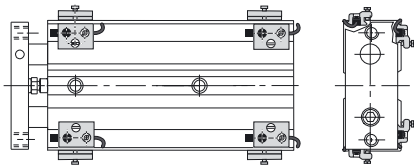
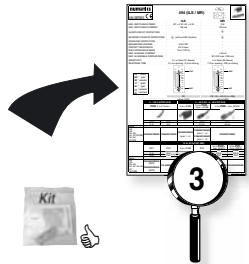
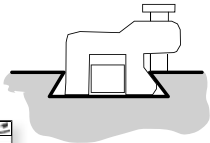

		<b>F</b>
Items:	N.m	Inch.pounds
C	0,5	4,41
D	0,4	3,5

series	Ø (mm)	
447 449	12 ... 32	<b>P494A0029400A00</b>

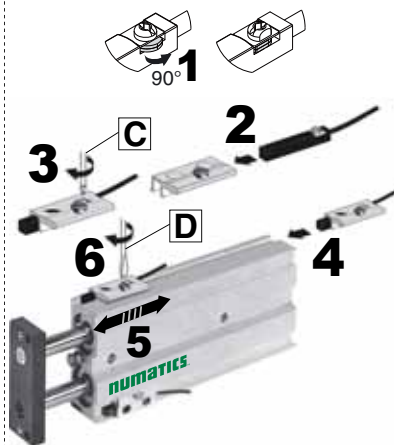
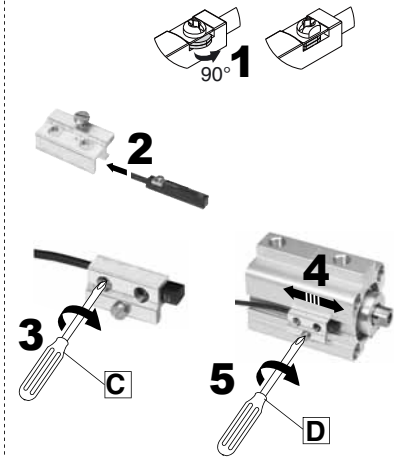

**numatics**

494 SERIES

**454 (MR)**  
**(FOR «C» GROOVES)**



	10..28 V DC	4,5..28 V DC
Max. switching power	0,6 W	1,5 W
Max. switching current	4-20 mA	50 mA
Number of wires	2	3
Reverse polarity protection		
Overload protection		
Short-circuit protection		
Voltage drop	3,5 V	0,5 V (50 mA)
Max. leakage current	0,8 mA	0,01 mA
Max. allowable overvoltage	30 V DC	
Sensitivity	40 Gauss	
Response time	1000 Hz	
Repeatability	0,5 mm	
Working temperature	-10 .. + 70 °C	
Degree of protection	IP67	
Signal indication (LED)	RED	



	10..28 V DC		4,5..28 V DC	
	2 wires		3 wires	
	5 m (PVC)	0,3 m (PVC) + M8	5 m (PVC)	0,3 m (PVC) + M8
441	<b>P494A0011100A00</b>	<b>P494A0011200A00</b>	<b>P494A0012100A00</b>	<b>P494A0012200A00</b>

**numatics**

494 SERIES

**MR**  
(FOR «C» GROOVES)

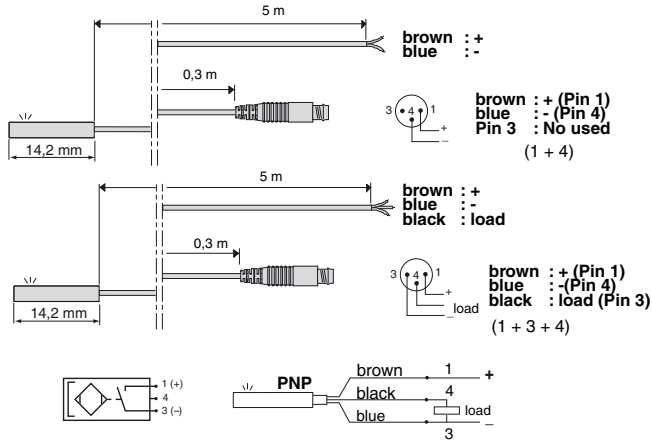

	br (+)	blu (-)	blk (load)
GB	brown	blue	black
FR	marron	bleu	noir
DE	braun	blau	schwarz
ES	marrón	azul	negro
IT	marrone	blu	nero
NL	bruin	blauw	zwart
PT	castanho	azul	preto
RU	коричневый	синий	черный

EN

- Do not subject the detector's power supply cable to damaging traction / torsion during its service life.
- Output protected against short-circuit as long as the output current is restricted to 0,1 A.
- Improper wire connection may prevent the detector from operating or even destroy it.
- It is recommended to install a protection diode (mounted in parallel) on an inductive load in spite of the internal protection.

Polarities to be observed

FR

- S'assurer que le câble électrique d'alimentation du détecteur n'est pas soumis à des tractions / torsions néfastes à sa durée de vie
- Sortie protégée contre les courts-circuits éventuels de la charge lorsque le courant de sortie est inférieur ou égal à 0,1 A.
- Le branchement incorrect des fils de sortie peut entraîner le non fonctionnement ou la destruction du mini-détecteur.
- Malgré la protection interne, dans le cas de charge selfique, il est recommandé d'utiliser une diode (montée en parallèle) sur la charge

Respecter les polarités

DE

- Achten Sie darauf, dass das Spannungsversorgungskabel des Näherungsschalters während der gesamten Lebensdauer ohne Zugbelastung verlegt und nicht verdreht wird.
- Der Ausgang ist gegen Kurzschluss geschützt, solange der Ausgangsstrom auf 0,1 A beschränkt wird.
- Unschonungemäßer elektrischer Anschluss verursacht eine Fehlfunktion des Näherungsschalters oder kann diesen zerstören.
- Trotz des interner Schutzes ist bei Anschluss einer induktiven Last eine Schutzdiode parallel zur induktiven Last zu legen.

Bitte Polarität beachten

ES

- Comprobar que el cable eléctrico de alimentación del detector no está sometido a tracciones / torsiones nefastas para su duración
- Salida protegida contra los corto-circuitos eventuales de la carga cuando la corriente de salida es inferior o igual a 0,1 A.
- La conexión incorrecta de los hilos de salida puede provocar el no funcionamiento o la destrucción del mini-detector.
- A pesar de la protección interna, en el caso de carga selfica, se recomienda utilizar un diodo (montado en paralelo) en la carga

Respetar las polaridades

IT

- Assicurarsi che il cavo elettrico d'alimentazione del finecorsa non sia sottoposto a trazioni / torsioni dannose al ciclo di vita
- Uscita protetta contro eventuali cortocircuiti di carico se la tensione d'uscita è inferiore o uguale a 0,1 A.
- L'errato collegamento dei fili può causare il mancato funzionamento o la distruzione del finecorsa.
- Si raccomanda di installare un diodo (montato in parallelo) o un carico induttivo nonostante la protezione interna.

Rispettare la polarità

NL

- Stel de stroomkabel van de detector niet bloot aan beschadigende tractie/torsie tijdens de levensduur.
- Aansluiting beveiligd tegen kortsluiting zolang de uitgangsstroom is beperkt tot 0,1 A.
- Een onjuiste draadaansluiting kan ertoe leiden dat de detector niet werkt of zelfs vernietigd wordt.
- Aanbevolen wordt een beveiligingsdiode te installeren (parallel gemonteerd) op een inductieve lading ondanks de interne beveiliging.

Polariteiten die in acht genomen moeten worden

PT

- Assegurar que o cabo elétrico de alimentação do detetor não está sujeito a trações/torsões prejudiciais à sua vida útil
- Saída protegida contra os eventuais curto-circuitos da carga quando a corrente de saída é inferior ou igual a 0,1 A.
- A ligação incorreta dos fios de saída pode impedir o não funcionamento ou a destruição do mini-detetor.
- Apesar da proteção interna, no caso de carga selfica, é recomendado utilizar um diodo (montado em paralelo) na carga.

RU

- Кабель питания датчика не должен сильно натягиваться или перекручиваться на протяжении всего срока службы.
- Выход защищен от коротких замыканий, если сила тока на выходе ограничена значением 0,1 А.
- Неправильное подключение проводов может помешать работе датчика или даже уничтожить его.
- Вместо внутренней защиты рекомендуется установить защитный диод (подключается параллельно) для индуктивной нагрузки.

**numatics**

494 SERIES

**ACCESSORIES**  
(FOR «C» GROOVES)

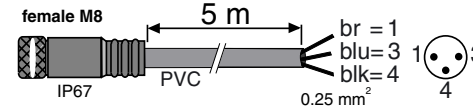

P4994406200N001

female M8



P4994406220N001

female M8



P4994406230N001

	br	blu	blk
GB	brown	blue	black
FR	marron	bleu	noir
DE	braun	blau	schwarz
ES	marrón	azul	negro
IT	marrone	blu	nero
NL	bruin	blauw	zwart
PT	castanho	azul	preto
RU	коричневый	синий	черный

**numatics**

494 SERIES

# MOUNTING (FOR «C» GROOVES)

Series: 441

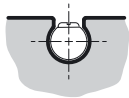

Ø 8 → 25



Ø 32 → 100

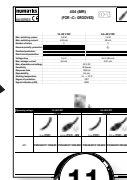
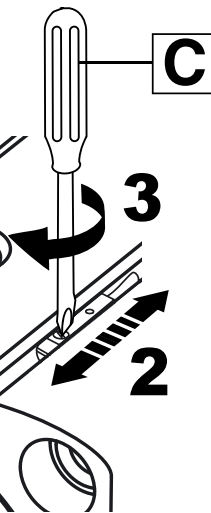
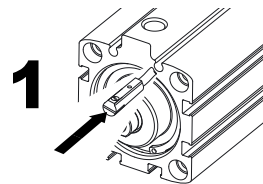
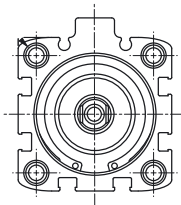
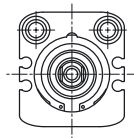

items	N.m	Inch.pounds
C	0,5	4,41

**numatics**

494 SERIES

# RECOMMENDATIONS

- |    |   |
|----|---|
| EN | <ul style="list-style-type: none"> <li>- Do not mount position detectors near to ferromagnetic or intense electromagnetic fields (solenoid coil, soldering tongs etc.).</li> <li>- PUR, resistant to cutting oils. Check to ensure the compatibility of the PVC cables with the oil and solvent environments (contact us). Clean with an alkaline solution (soapy water).</li> <li>- Not pinch the cables when using a retaining ring plier. The minimum tightening torque must be observed (for cable dia. 2 - 2.5 mm).</li> <li>- Observe a minimum bending radius of 15 mm in static assembly.</li> <li>- Any modification to the equipment shall be subject to the prior approval of ASCO Numatics.</li> </ul>  |
| FR | <ul style="list-style-type: none"> <li>- Éviter le montage des détecteurs de positions à proximité de toute présence ferromagnétique ou électromagnétique intense (bobine, pince à soudage, etc ...).</li> <li>- PUR résistant aux huiles de coupe. Ne pas utiliser en environnement d'huiles ou solvants incompatibles avec le câble en PVC suivant version. Nettoyage avec solution alcaline (eau savonneuse).</li> <li>- Ne pas écraser les câbles notamment lors d'utilisation de pince à collier serre-câble. A régler impérativement sur serrage mini (pour câble Ø 2 - 2,5 mm).</li> <li>- Respecter un rayon de courbure de 15 mm mini. en montage statique</li> <li>- Aucune modification ne peut être réalisée sur le matériel sans l'accord préalable d'ASCO Numatics.</li> </ul>          |
| DE | <ul style="list-style-type: none"> <li>- Näherungsschalter nicht neben intensiven ferromagnetischen oder elektromagnetischen Störquellen (Magnetspulen, Schweißzangen) montieren.</li> <li>- PUR, schneidölbeständig. Die Kompatibilität der PUV-Kabel mit den öl- und lösemittelhaltigen Umgebungen ist sicherzustellen. Reinigung mit einem alkalischen Mittel durchführen (Seifenwasser).</li> <li>- Darauf achten, dass die Kabel insbesondere bei der Verwendung von Zangen zur Montage des Klemmbands nicht gequetscht werden. Der Mindestanziehmoment (bei Kabel Ø 2 - 2,5 mm) ist unbedingt zu beachten.</li> <li>- Bei einer statischen Montage ist ein Biegeradius von mindestens 15 mm zu beachten.</li> <li>- Änderungen bedürfen der vorherigen Zustimmung von ASCO Numatics.</li> </ul> |
| ES | <ul style="list-style-type: none"> <li>- Evitar el montaje de los detectores de posición próximo de toda presencia ferromagnética o electromagnética intensa (bobina, pinza de soldadura, etc ...).</li> <li>- PUR, resistente a los aceites de corte. No utilizar en entornos con aceites o disolventes incompatibles con el cable de PVC según versión. Limpieza con solución alcalina (agua jabonosa).</li> <li>- No fragmentar los cables particularmente durante la utilización de la pinza de brida abrazadera. Regular imperativamente con apriete mínimo (para cable Ø 2 - 2,5 mm).</li> <li>- Respetar un radio de curvatura de 15 mm min. en montaje estático</li> <li>- No puede realizarse ninguna modificación en el material sin ASCO Numatics acuerdo previo.</li> </ul>               |
| IT | <ul style="list-style-type: none"> <li>- Evitare il montaggio dei finecorsa vicino a fonti ferromagnetiche o elettromagnetiche intense (bobina, pinza per saldatura, ecc ...).</li> <li>- PUR, resistente agli olii da taglio. Non utilizzare in ambiente con oli o solventi incompatibili con il cavo in PVC a seconda della versione. Pulizia con soluzione alcalina (acqua saponosa).</li> <li>- Non schiacciare i cavi specialmente quando si utilizza un collare serracavo. Regolare tassativamente sul serraggio min.(per cavo Ø 2 - 2,5 mm).</li> <li>- Rispettare un raggio di curvatura di 15 mm min. in montaggio statico</li> <li>- Non è possibile realizzare alcuna modifica sul materiale senza ASCO Numatics preventivo accordo.</li> </ul>  |
| NL | <ul style="list-style-type: none"> <li>- Positiedetectores niet monteren in de buurt van ferromagnetische of intensieve elektromagnetische velden (solenoid spoel, soldeertangen, enz).</li> <li>- PUR, bestand tegen snijoliën. Controleer of de PVC kabels compatibel zijn met de olie- en oplossings-middelomgeving. Reinig met een alkalineoplossing (zeepwater).</li> <li>- Niet in de kabels knijpen wanneer u een klemringtang gebruikt. Het minimale aandraaimoment moet in acht worden genomen (voor kabeldoorsnede 2 / 2,5 mm).</li> <li>- Neem een minimale buigstraal van 15 mm in acht in statische opstelling.</li> <li>- Eventuele wijzigingen aan de apparatuur dienen vooraf te worden goedgekeurd door ASCO Numatics.</li> </ul>  |
| PT | <ul style="list-style-type: none"> <li>- Evitar a montagem dos detetores de posição próximo de qualquer presença ferromagnética ou eletromagnética intensa, (bobina, pinça de soldadura, etc...).</li> <li>- PUR, resistente aos óleos de corte. Não utilizar em ambiente com óleos ou dissolventes incompatíveis com o cabo em PVC segundo versão. Limpeza com solução alcalina (água com sabão).</li> <li>- Não fragmentar os cabos particularmente durante a utilização da flange abraçadeira. Regular imperativamente com aperto mínimo (para cabo Ø 2 - 2,5 mm).</li> <li>- Respetar um raio de curvatura de 15 mm min. em montagem estática</li> <li>- Não se pode realizar qualquer modificação no material sem a aprovação prévia da ASCO Numatics.</li> </ul>                                |
| RU | <ul style="list-style-type: none"> <li>- Не устанавливайте датчики положения рядом с ферромагнитными или сильными электромагнитными полями (обмотка электромагнита, паяльные щипцы и т.д.).</li> <li>- PUR, устойчивость к смазочно-охлаждающим маслам. Проверьте соответствие поливинилхлоридного кабеля типу масла и растворителя (свяжитесь с нами для консультации). Чистить щелочным раствором (мыльная вода).</li> <li>- Избегать защемления кабеля при использовании стопорного кольца. Необходимо учитывать минимальный крутящий момент (для кабеля диам. 2 - 2,5 мм).</li> <li>- Учитывайте минимальный радиус изгиба, составляющий 15 мм в статической сборке.</li> <li>- Внесение любых изменений в оборудование подлежит предварительному утверждению компанией ASCO Numatics.</li> </ul> |

