

# G6C

PCB Power Relay

## Miniature High Capacity Relays with SPST-NO 10A and SPST-NO + SPST-NC 8A

- SPST-NO 10A and SPST-NO + SPST-NC 8A for power switching and output that satisfy the needs for space-saving.
- Small High-capacity Relays Compact: 20 × 15 × 10 mm (L × W × H).
- Low power consumption: 200 mW.
- Ultrasonically cleanable models is available.
- Exclusive P6C model for sockets is now available.

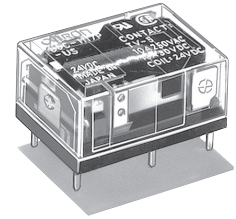
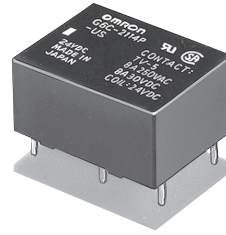

RoHS Compliant

### Model Number Legend

G6C-  -          -  -  -  -  

1    2   3   4   5   6   7   8   9

#### 1. Relay Function

- None: Single-side stable  
U : Single-winding latching  
K : Double-winding latching

#### 2. Contact Form

- 11: SPST-NO (1a)  
21: SPST-NO (1a) + SPST-NC (1b)

#### 3. Contact Type

- 1: Single

#### 4. Enclosure rating

- 4: Fully sealed  
7: Flux protection

#### 5. Terminal Shape

- P: PCB terminals  
Socket mounting Terminals

#### 6. Contact Material

- None: Standard (Ag-alloy (Cd free))  
FD : AgSnIn Contacts  
(Suitable for DC inductive load with high inrush current)

#### 7. Approved Standards

- US: UL/CSA

#### 8. Washability

- None: Standard model  
(not compatible with ultrasonically cleanable models)  
U : For ultrasonically cleanable

#### 9. Mounting

- None: Mounted directly to PCB  
P6C : Mounted to Socket

### Application Examples

Ideal for output applications of control equipments

G  
6  
C

## Ordering Information

### Standard Models (UL, CSA certified)

Enclosure rating	Relay Function Contact form	Single-side stable		Single-winding latching		Double-winding latching		Minimum packing unit		
		Model	Rated coil voltage	Model	Rated coil voltage	Model	Rated coil voltage			
Flux protection	SPST-NO (1a)	G6C-1117P-US	3 VDC	G6CU-1117P-US	3 VDC	G6CK-1117P-US	3 VDC	100 pcs/tray		
			5 VDC		5 VDC		5 VDC			
			6 VDC		–		6 VDC			
			12 VDC		12 VDC		12 VDC			
	SPST-NO (1a) + SPST-NC (1b)	G6C-2117P-US	G6CU-2117P-US	24 VDC	G6CK-2117P-US	G6CK-2117P-US	24 VDC		24 VDC	
				3 VDC			3 VDC		3 VDC	
				5 VDC			5 VDC		5 VDC	
				6 VDC			6 VDC		6 VDC	
Fully sealed	SPST-NO (1a)	G6C-1114P-US	12 VDC	G6CU-1114P-US	G6CK-1114P-US	G6CK-1114P-US	12 VDC	100 pcs/tray		
			24 VDC				24 VDC		24 VDC	
			3 VDC				3 VDC		3 VDC	
			5 VDC				5 VDC		5 VDC	
	SPST-NO (1a) + SPST-NC (1b)	G6C-2114P-US	G6CU-2114P-US	6 VDC	G6CK-2114P-US	G6CK-2114P-US	G6CK-2114P-US		6 VDC	
				12 VDC					12 VDC	12 VDC
				24 VDC					24 VDC	24 VDC
				3 VDC					3 VDC	3 VDC

Note1. When ordering, add the rated coil voltage to the model number.

Example: G6C-1117P-US DC3

Rated coil voltage

However, the notation of the coil voltage on the product case as well as on the packing will be marked as □□ VDC.

Note2. Products with UL/CSA certification marks will be supplied for orders of standard models (-US models).

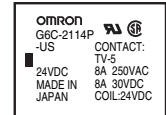
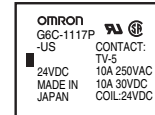

### Ultrasonically Cleanable Models (UL, CSA certified)

Enclosure rating	Relay Function Contact form	Single-side stable		Single-winding latching		Double-winding latching		Minimum packing unit		
		Model	Rated coil voltage	Model	Rated coil voltage	Model	Rated coil voltage			
Fully sealed	SPST-NO (1a)	G6C-1114P-US-U	3 VDC	G6CU-1114P-US	–	G6CK-1114P-US	–	100 pcs/tray		
			5 VDC		5 VDC		5 VDC			
			6 VDC		–		–			
			12 VDC		12 VDC		12 VDC			
	SPST-NO (1a) + SPST-NC (1b)	G6C-2114P-US-U	G6CU-2114P-US	24 VDC	G6CK-2114P-US	G6CK-2114P-US	G6CK-2114P-US		24 VDC	
				–					–	–
				5 VDC					–	5 VDC
				–					–	–
			12 VDC				12 VDC			
			–				–	–		
			24 VDC				–	–		
			–				–	–		

Note1. When ordering, add the rated coil voltage to the model number.

Example: G6C-1114P-US-U DC3

Rated coil voltage

However, the notation of the coil voltage on the product case as well as on the packing will be marked as □□ VDC.

Note2. Products with UL/CSA certification marks will be supplied for orders of standard models (-US models).

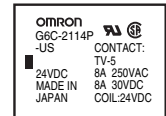
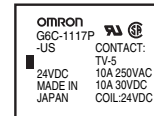

### Connecting Sockets (Sold Separately)

Applicable relays	Model	Minimum packing unit
G6C-2114P-US-P6C G6C-2117P-US-P6C G6C-1114P-US-P6C G6C-1117P-US-P6C G6CU-2114P-US-P6C G6CU-2117P-US-P6C G6CU-1114P-US-P6C G6CU-1117P-US-P6C	P6C-06P	20 pcs/tube
G6CK-2114P-US-P6C G6CK-2117P-US-P6C G6CK-1114P-US-P6C G6CK-1117P-US-P6C	P6C-08P	
Removal Tool	P6B-Y1	1
Hold-down Clips	P6B-C2	

Note 1. Use the G6C-□□□□P-US-P6C to mount to a P6C Socket.

2. When using by combining sockets, the rated current will be 5A due to its rated switching current.

## ■ Ratings

### Coil: 1-Pole, Single-side Stable Type (Including models for ultrasonically cleanable)

Item	Rated current (mA)	Coil resistance (Ω)	Must operate voltage (V)	Must release voltage (V)	Max. voltage (V)	Power consumption (mW)
Rated voltage			% of rated voltage			
3 VDC	67	45	70% max.	10% min.	160% (at 23°C)	Approx. 200
5 VDC	40	125				
6 VDC	33.3	180				
12 VDC	16.7	720				
24 VDC	8.3	2,880				

### Coil: Single-winding Latching Type (Including models for ultrasonically cleanable)

Item	Rated current (mA)	Coil resistance (Ω)	Must set voltage (V)	Must reset voltage (V)	Max. voltage (V)	Power consumption	
						Set coil (mW)	Reset coil (mW)
Rated voltage			% of rated voltage				
3 VDC	67	45	70% max.	70% max.	160% (at 23°C)	200	200
5 VDC	40	125					
6 VDC	33.3	180					
12 VDC	16.7	720					
24 VDC	8.3	2,880					

### Coil: Double-winding Latching Type (Including models for ultrasonically cleanable)

Item	Rated current (mA)		Coil resistance (Ω)		Must set voltage (V)	Must reset voltage (V)	Max. voltage (V)	Power consumption	
	Set coil	Reset coil	Set coil	Reset coil				Set coil (mW)	Reset coil (mW)
Rated voltage					% of rated voltage				
3 VDC	93.5	93.5	32.1	32.1	70% max.	70% max.	130% (at 23°C)	280	280
5 VDC	56.0	56.0	89.3	89.3					
6 VDC	46.7	46.7	129	129					
12 VDC	23.3	23.3	514	514					
24 VDC	11.7	11.7	2,056	2,056					

Note 1. The rated current and coil resistance are measured at a coil temperature of 23°C with a tolerance of ±10%.

2. The operating characteristics are measured at a coil temperature of 23°C.

3. The "Max. voltage" is the maximum voltage that can be applied to the relay coil.

## Contact

Contact Form	SPST-NO (1a)		SPST-NO (1a) + SPST-NC (1b)	
	Resistive load	Inductive load (cosφ = 0.4; L/R = 7 ms)	Resistive load	Inductive load (cosφ = 0.4; L/R = 7 ms)
Rated load	10 A (8 A) at 250 VAC 10 A (10 A) at 30 VDC	5 A (5 A) at 250 VAC 5 A (5 A) at 30 VDC	8 A (8 A) at 250 VAC 8 A (8 A) at 30 VDC	3.5 A (3.5 A) at 250 VAC 3.5 A (3.5 A) at 30 VDC
Item				
Contact type	Single			
Contact material	Ag-Alloy (Cd free)			
Rated carry current	10 A (10 A)		8 A (8 A)	
Max. switching voltage	380 VAC, 125 VDC			
Max. switching current	10 A (10 A)		8 A (8 A)	

Note. The values shown in parentheses ( ) are for -FD models only.

## Characteristics (Including models for ultrasonically cleanable)

Item	Classification	Single-side Stable	Single-winding Latching	Double-winding Latching
Contact resistance *1		30 mΩ max.		
Operate (set) time		10 ms max.		
Release (reset) time		10 ms max.		
Min. set pulse width		-	20 ms (at 23°C)	
Min. reset pulse width		-	20 ms (at 23°C)	
Insulation resistance *2	Between coil and contacts	1,000 MΩ min.		
	Between contacts of the same polarity	1,000 MΩ min.		
	Between contacts of different polarity	1,000 MΩ min. (SPST-NO, SPST-NC)		
	Between set and reset coils	-	-	1,000 MΩ min.
Dielectric strength	Between coil and contacts	2,000 VAC 50/60Hz for 1min		
	Between contacts of the same polarity	1,000 VAC 50/60Hz for 1min		
	Between contacts of different polarity	2,000 VAC 50/60Hz for 1min (SPST-NO, SPST-NC)		
	Between set and reset coils	-	-	250 VAC 50/60Hz for 1min
Vibration resistance	Destruction	10 to 55 to 10 Hz, 0.75 mm single amplitude (1.5 mm double amplitude)		
	Malfunction	10 to 55 to 10 Hz, 0.75 mm single amplitude (1.5 mm double amplitude)		
Shock resistance	Destruction	1,000 m/s <sup>2</sup>		
	Malfunction	100 m/s <sup>2</sup>		
Durability	Mechanical	50,000,000 operations min. (at 18,000 operations/hr)		
	Electrical	100,000 operation min. (at 1,800 operations/hr under rated load)		
Failure rate (P level) (reference value) *3		10 mA at 5 VDC		
Ambient operating temperature		-25°C to 70°C (with no icing or condensation)		
Ambient operating humidity		5% to 85%		
Weight		Approx. 5.6 g		

Note. The given values are initial values.

\*1. Measurement conditions: 5 VDC, 1 A, voltage drop method.

\*2. Testing conditions: measured with a 500 VDC megohmmeter (at 250 VDC between set/reset coil).

\*3. This value was measured at a switching frequency of 120 operations/min.

## Engineering Data

### Maximum Switching Capacity

G6C-1114P-US

G6C-1117P-US

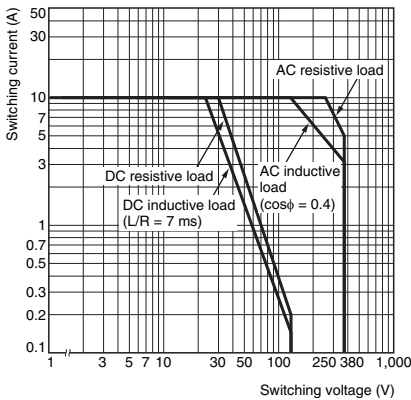

G6C-1114P-FD-US

G6C-1117P-FD-US

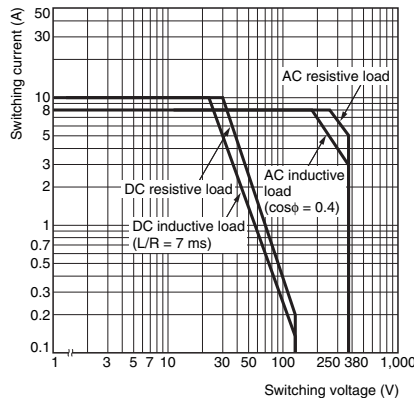

G6C-2114P-US

G6C-2117P-US

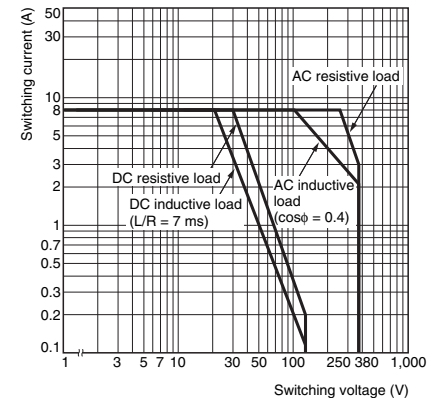

G6C-2114P-FD-US

G6C-2117P-FD-US

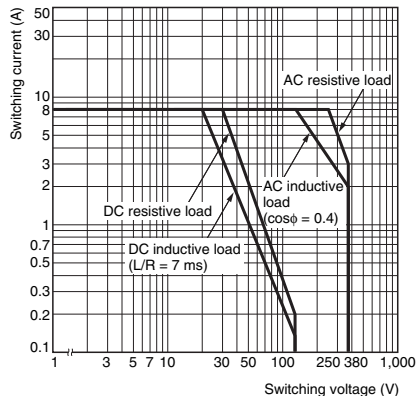

## ● Durability

G6C-1114P-US, G6C-2114P-US  
G6C-1117P-US, G6C-2117P-US

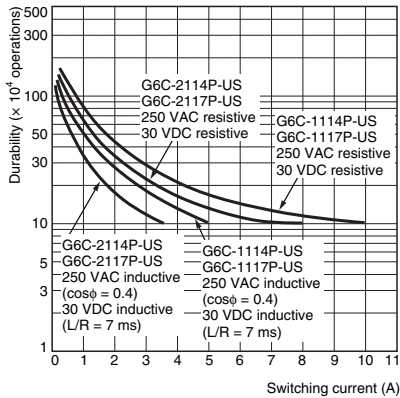

G6C-1114P-FD-US, G6C-2114P-FD-US  
G6C-1117P-FD-US, G6C-2117P-FD-US

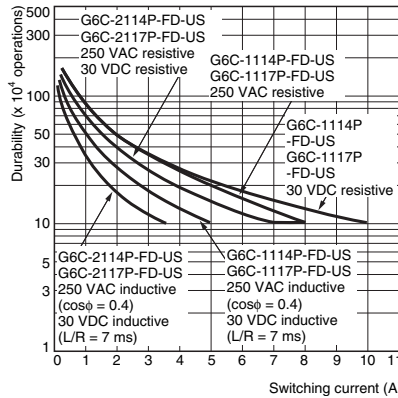

## ● Ambient Temperature vs. Maximum Coil Voltage

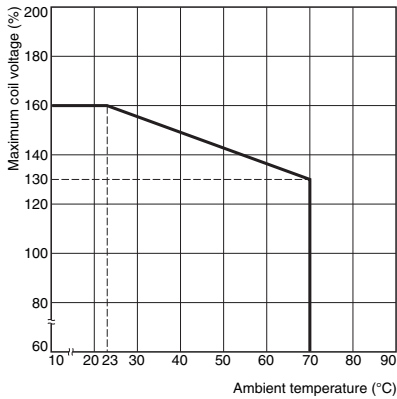

Note. The maximum coil voltage refers to the maximum value in a varying range of operating power voltage, not a continuous voltage.

## ● Ambient Temperature vs Must Operate and Must Release voltages

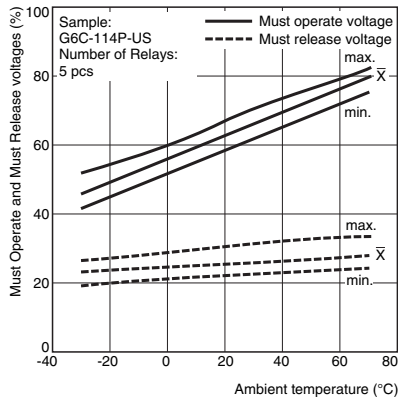

## ● Shock Malfunction

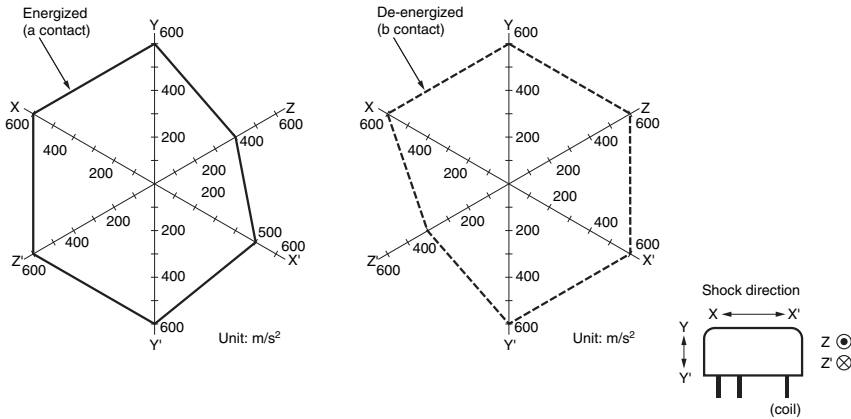

Sample: G6C-2114P-US DC24V  
Number of Relays: 6 pcs  
Test conditions: Shock is applied in ±X, ±Y, and ±Z directions three times each with without energizing the Relays to check the number of malfunctions.  
Requirement: 100 m/s<sup>2</sup>

## Magnetic Interference (between Relays)

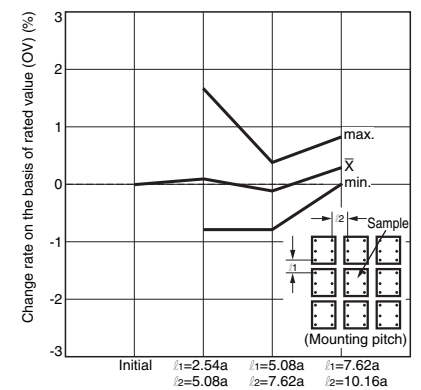

## ■ Dimensions

### Flux Protection Model G6C-□117P-US

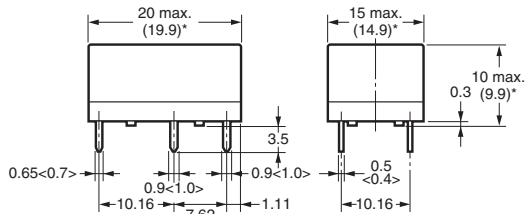
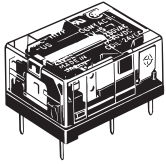

\* Average value

Dimensions in pointed brackets < > are for the Relay mounted to Socket(-P6C).

### PCB Mounting Holes (Bottom View) Tolerance: $\pm 0.1$

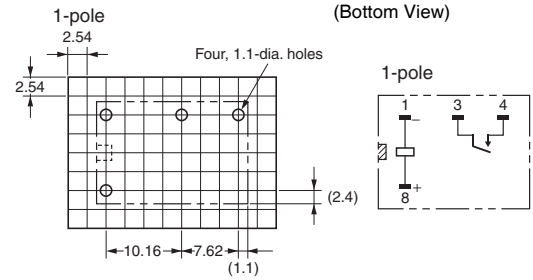

### Terminal Arrangement/ Internal Connections (Bottom View)

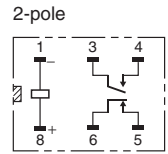
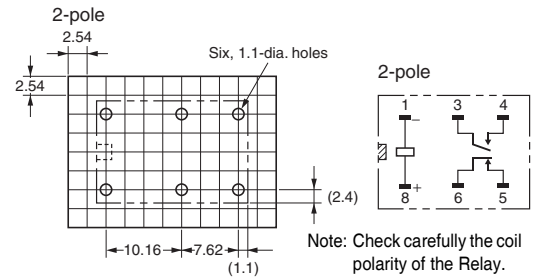
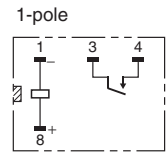

Note: Check carefully the coil polarity of the Relay.

Note: Orientation mark is indicated as follows:

### Fully Sealed Model G6C-□114P-US

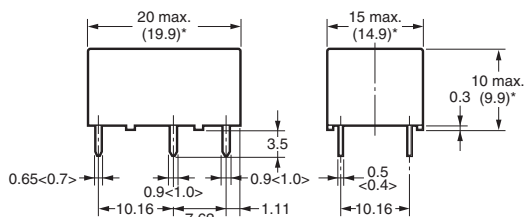
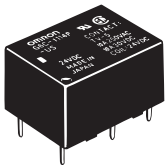

\* Average value

Dimensions in pointed brackets < > are for the Relay mounted to Socket(-P6C).

### PCB Mounting Holes (Bottom View) Tolerance: $\pm 0.1$

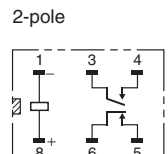
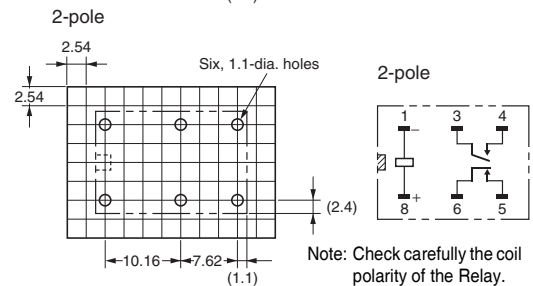
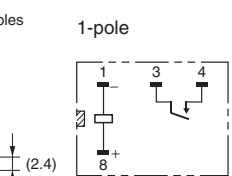
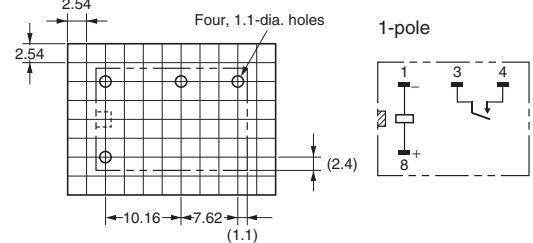

Note: Check carefully the coil polarity of the Relay.

## Flux Protective Single-winding Latching Model G6CU-□117P-US

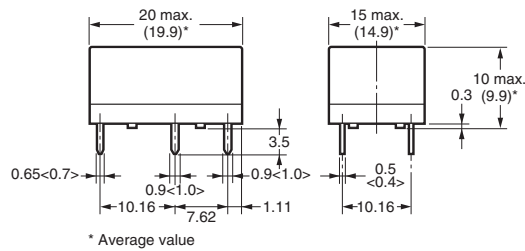
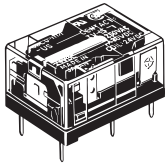

Dimensions in pointed brackets < > are for the Relay mounted to Socket(-P6C).

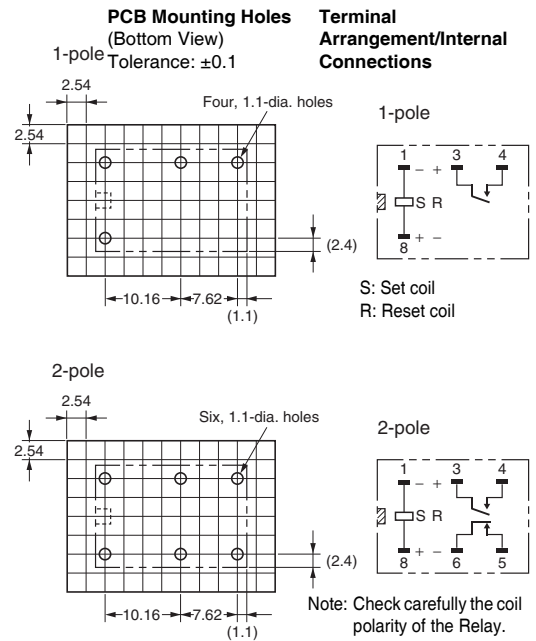

## Fully Sealed Model Single Latching Models G6CU-□114P-US

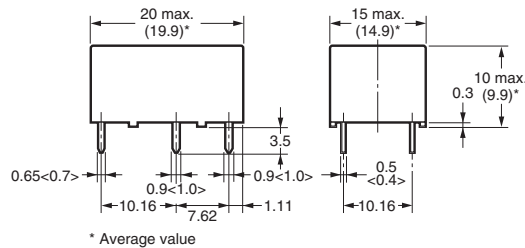
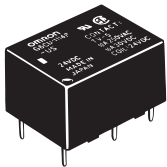

Dimensions in pointed brackets < > are for the Relay mounted to Socket(-P6C).

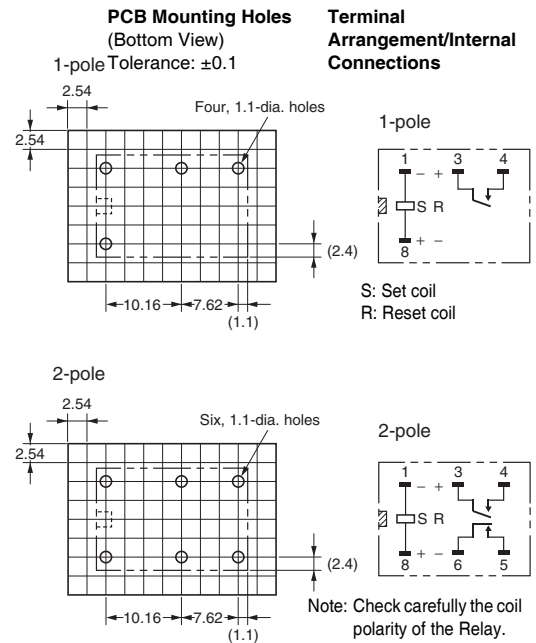

Note: Orientation marks are indicated as follows: □ ▨

## Flux Protective Double-winding Latching Model G6CK-□117P-US

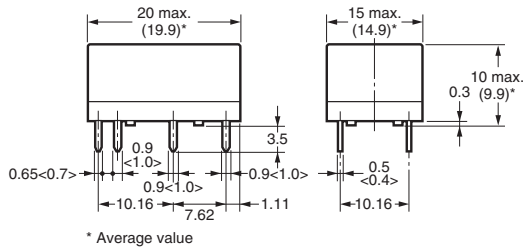
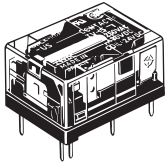

Dimensions in pointed brackets < > are for the Relay mounted to Socket(-P6C).

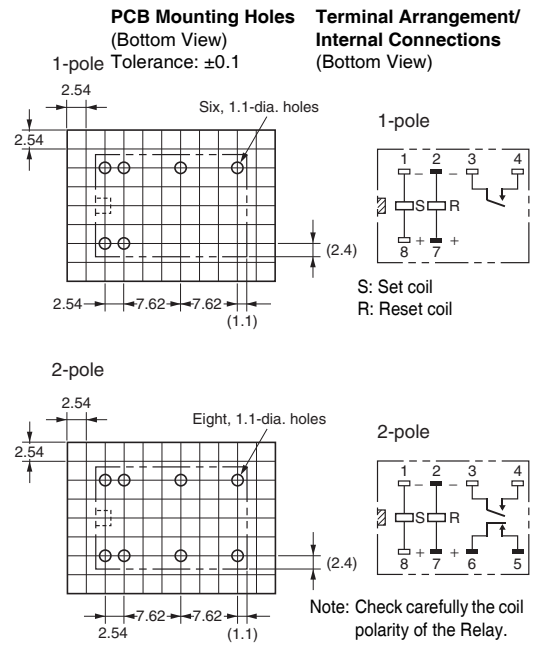

## Fully Sealed Double-winding Latching Model G6CK-□114P-US

G  
6  
C

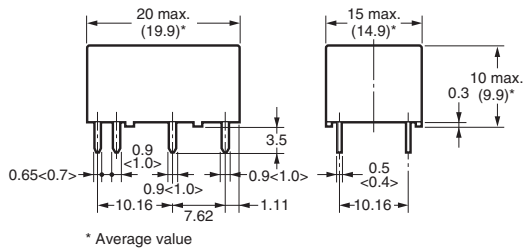
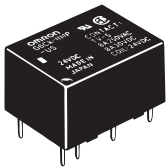

Dimensions in pointed brackets < > are for the Relay mounted to Socket(-P6C).

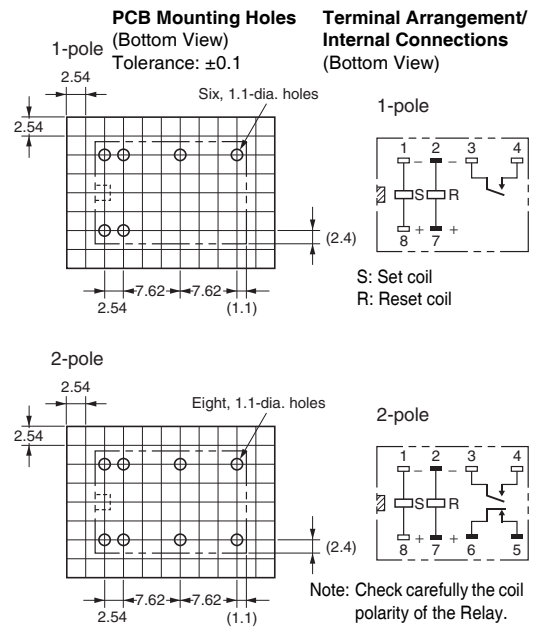



## ■Connecting Sockets Dimensions

### Socket for single-winding latching/single-side a table Models

P6C-06P

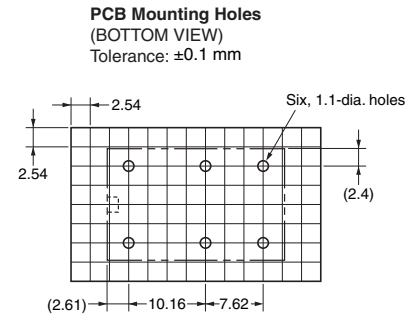
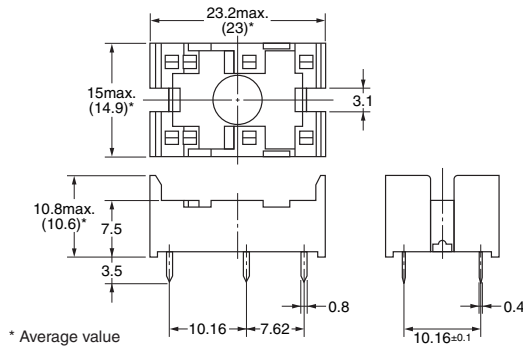
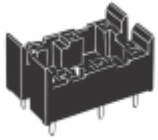

### Socket for double-winding latching Models

P6C-08P

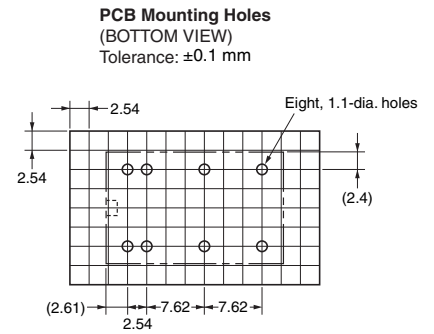
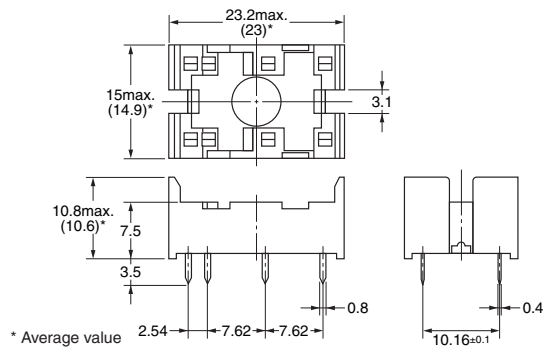
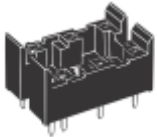

Note: Orientation marks are indicated as follows: □ ▨

## ■ Removal Tool

P6B-Y1

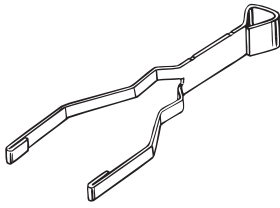

## ■ Hold-down Clips

P6B-C2

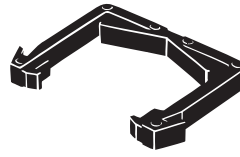

## ■ Approved Standards

● The rated values approved by each of the safety standards may be different from the performance characteristics individually defined in this catalog.

**UL Recognized**  (File No. E41643)

Model	Number of poles	Coil ratings	Contact ratings	Number of test operations
G6C ( )	1	3 to 24 VDC	10 A, 250 VAC 80°C	6,000
			10 A, 30 VDC 80°C	
			1/6 HP 250 VAC, 1/4 HP, 125 VAC 80°C	
	1/3 HP 250 VAC, 1/4 HP, 250 VAC 80°C			
	600 W, 120 VAC, (Tungsten) 80°C			
	530 VA, 20~265 VAC Max 2A (Pilot Duty) 80°C		30,000	
43.2 VA, 30 VDC (Pilot Duty) 80°C				
12 LRA, 2.2 FLA 30 VDC 80°C				
2	8 A, 250 VAC 80°C	6,000		
			8 A, 30 VDC 80°C	
			1/6 HP, 125 VAC, 1/4 HP, 125 VAC 80°C	
	1/4 HP, 250 VAC 80°C			
	600 W, 120 VAC (Tungsten) 80°C			
	530 VA, 20~265 VAC Max 2A (Pilot Duty) 80°C		30,000	
43.2 VA, 30 VDC (Pilot Duty) 80°C				
12 LRA, 2.2 FLA, 30 VDC 80°C				

**CSA Certified**  (File No. LR31928)

Model	Number of poles	Coil ratings	Contact ratings	Number of test operations
G6C ( )	1	3 to 24 VDC	10 A, 250 VAC 80°C	6,000
			10 A, 30 VDC 80°C	
			1/6 HP 125 VAC, 1/4 HP, 125 VAC 80°C	
	1/3 HP 250 VAC, 1/4 HP, 250 VAC 80°C			
	600 W, 120 VAC, (Tungsten) 80°C			
	530 VA, 20~265 VAC Max 2A (Pilot Duty) 80°C		6,000	
43.2 VA, 30 VDC (Pilot Duty) 80°C				
8 A, 250 VAC 80°C				
2	8 A, 250 VAC 80°C	6,000		
			8 A, 30 VDC 80°C	
			1/6 HP, 125 VAC, 1/4 HP, 125 VAC 80°C	
	1/4 HP, 250 VAC 80°C			
	600 W, 120 VAC (Tungsten) 80°C			
	530 VA, 20~265 VAC Max 2A (Pilot Duty) 80°C		6,000	
43.2 VA, 30 VDC (Pilot Duty) 80°C				
8 A, 250 VAC 80°C				

**EN/IEC, VDE Certified**  (Certificate No. 40014439)

Model	Number of poles	Coil ratings	Contact ratings	Approved switching operations
G6C ( )	1	3, 5, 6, 12, 24 VDC	10 A, 250 VAC ( $\cos\phi = 1$ ) 40°C 5 A, 250 VAC ( $\cos\phi = 0.4$ ) 40°C	20,000
	2	• Single-stable: 3, 5, 6, 12, 24 VDC	7 A, 250 VAC ( $\cos\phi = 1$ ) 40°C 3.5 A, 250 VAC ( $\cos\phi = 0.4$ ) 40°C	

**EN/IEC, TÜV Certified**  (Registration No. R50158249)

Model	Number of poles	Coil ratings	Contact ratings	Approved switching operations
G6C ( )	1	• Single-stable: 3, 5, 6, 12, 24 VDC	10 A, 250 VAC ( $\cos\phi = 1$ ) 40°C 5 A, 250 VAC ( $\cos\phi = 0.4$ ) 40°C 10 A, 30 VDC (L/R = 0 ms) 40°C	20,000
	2	• Latching: 3, 5, 6, 12, 24 VDC	8 A, 250 VAC ( $\cos\phi = 1$ ) 40°C 3.5 A, 250 VAC ( $\cos\phi = 0.4$ ) 40°C 8 A, 30 VDC (L/R = 0 ms) 40°C	

## Precautions

● Please refer to “PCB Relays Common Precautions” for correct use.

### Correct Use

#### ● Mounting

- Do not reverse the polarity of the coil (+, -).
- When mounting more than two relays side by side, keep the gap between Relays as shown below to ensure a good heat dissipation. It may result in malfunction if heat is not dissipated smoothly from the Relay.

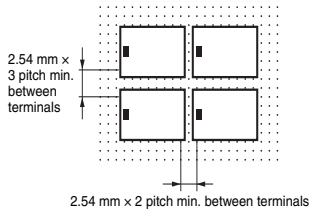

#### ● Sockets

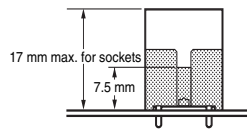

- When mounting the Relay, make sure to insert the Relay terminals perpendicularly and correctly into the socket contact pin.
- Hold-down clips (for mounting and removal) are also available.
- The P6C model has a flux-resistant construction. Do not wash it down with water.
- The max. carry current of sockets is 5A.

#### ● Double-winding Latching Circuit

- It is recommended to perform wiring of No.1 and No.2 of the negative (-) terminal as COM wiring, in order to improve the operation stability for Double-winding Latching.

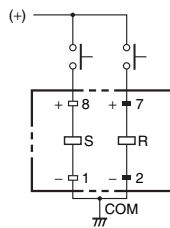

#### ● Using SPDT contact of the SPST-NO+SPST-NC Relay

- Do not construct a circuit so that overcurrent and burning occur if the NO, NC and SPDT contacts are short-circuited with the SPST-NO+SPST-NC Relay. Arcing may generate short-circuiting between contacts if there is short-circuiting because of conversion to the MBB contact caused by asynchronous operation of the NO and NC contacts, the interval between the NO and NC contacts is small, or a large current is left open.
- #### ● Other precautions
- This Relay is a Power Relay which is suitable for power load switching. Do not use the G6C for signal purposes such as micro load switching under 10 mA.

Application examples provided in this document are for reference only. In actual applications, confirm equipment functions and safety before using the product.  
Consult your OMRON representative before using the product under conditions which are not described in the manual or applying the product to nuclear control systems, railroad systems, aviation systems, vehicles, combustion systems, medical equipment, amusement machines, safety equipment, and other systems or equipment that may have a serious influence on lives and property if used improperly. Make sure that the ratings and performance characteristics of the product provide a margin of safety for the system or equipment, and be sure to provide the system or equipment with double safety mechanisms.

**Note: Do not use this document to operate the Unit.**