

Datasheet

RS PRO PLCC SOCKET, 84 POSITION, SMT, TIN PLATED

Stock No: 2272211



Product Details:

RS PRO SMT PLCC Series Sockets are low profile, thin wall sockets designed to convert plastic leaded chips to a thru-hole PCB format on a .100" centerline grid. They conform to JEDEC MS 016 and MS 018 pin count standards. RS PRO superior precision stamped contact design provides consistent, high retention contacts for all size chips. Chip exchanges or replacements are easily made with RS PRO chip remover part number PLCC-EXT.

Features & Benefits:

- Full range of sizes from 20P ~ 100P
- Consistent, uniform high retention contacts
- Compatible with wide range of chip sizes
- No solder wicking design
- Hi Temp PPS insulator
- Open frame design for viewable solder joints

SPECIFICATION:

Material:

Insulator: Hi-temp thermoplastic, rated UL 94V-0

Insulator color: Brown

Contacts: Phosphor Bronze

Plating:

Tin over Copper underplate overall

Electrical:

Current rating: 1 Amp

Contact resistance: 30 mohms max

Insulation resistance: 1000 Mohms min

Dielectric withstanding voltage: 500 VAC for 1 minute

Temperature Rating:

-55°C to +105°C

Environmental:

Lead free, RoHS Compliant.

Dimensional line drawings

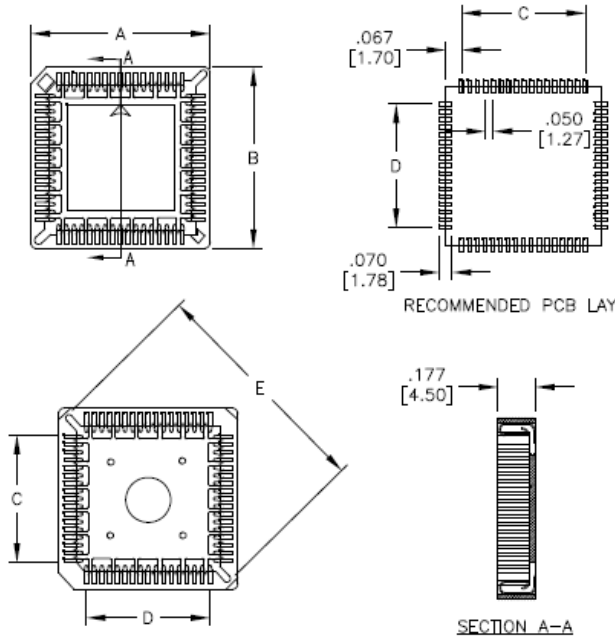

POSITIONS	A	B	C	D	E
20	.600 [15.24]	.600 [15.24]	.200 [5.08]	.200 [5.08]	.657 [16.70]
28	.700 [17.78]	.700 [17.78]	.300 [7.62]	.300 [7.62]	.799 [20.30]
32	.717 [18.20]	.817 [20.74]	.300 [7.62]	.400 [10.16]	.896 [22.76]
44	.917 [23.28]	.917 [23.28]	.500 [12.70]	.500 [12.70]	1.104 [28.05]
52	1.013 [25.74]	1.013 [25.74]	.600 [15.24]	.600 [15.24]	1.226 [31.13]
68	1.213 [30.82]	1.213 [30.82]	.800 [20.32]	.800 [20.32]	1.508 [38.31]
84	1.413 [35.90]	1.413 [35.90]	1.000 [25.40]	1.000 [25.40]	1.791 [45.50]



General

Extra page for more complex