

"weatherproof", for outdoor installation

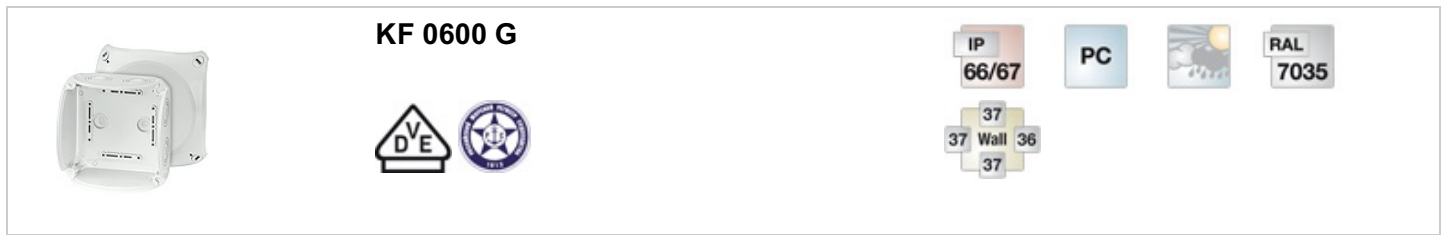

- without terminals
- with one cable entry M 25 from the rear side
- Cable entries via knockouts, order AKM separately (see cable entry systems LES)
- "weatherproof" resistant to weather influences (UV due to solar radiation, protected against rainwater, temperature resistant, impact resistant, etc.)
- saltwater-proof
- "Offshore applications"
- lid fasteners sealable without accessories
- colour: grey, RAL 7035

Degree of protection:	IP 66 / IP 67 temporary submersion up to 1 meter, max. 15 minutes
Material:	PC (Polycarbonate)
mounting width	102 mm
mounting height	102 mm
max. installation depth	62 mm
width	130 mm
height:	130 mm
depth	77 mm
Weight	0,215 kg
in accordance with	IEC 60 670-22
in accordance with	Russian Maritime Register of Shipping, technical documentation is approved by the letter No. 250-A-1180-108795

Drawings

Dimension drawing

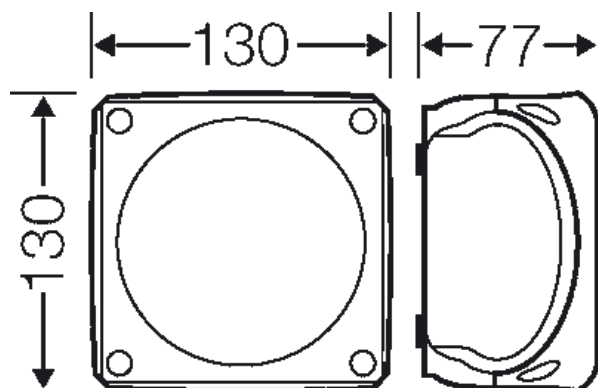

"weatherproof", for outdoor installation



**KF 0600 G**



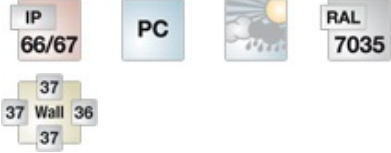

Detail mass

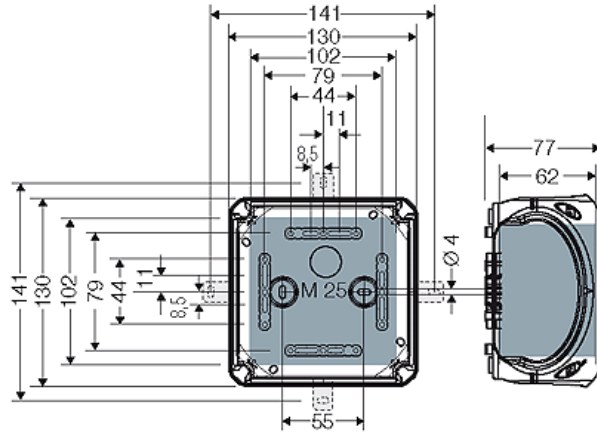

Box walls



36



1 x M 20/25/32

37









2 x M 20/25/32

### Operating and ambient conditions

Application area	Suitable for outdoor installation (harsh environment and/or outdoor). To reduce the formation and accumulation of condensed water see technical information.
Resistant to occasional cleaning procedures (direct jet)	Resistant to occasional cleaning procedures (direct jet) with high-pressure cleaner without additives, water pressure: max. 100 bar, water temperature: max. 80 °C, distance => 0,15 m, in accordance with the requirements IP 69K, enclosure and cable glands at least IP 65
Ambient temperature	Average value over 24 hours + 55 °C Maximum value + 70 °C Minimum value - 25 °C
Fire protection in the event of internal faults	Demands placed on electrical devices from standards and laws Minimum requirements - Glow wire test in accordance with IEC 60 695-2-11: - 650°C for boxes and cable glands - 850°C for parts of insulating material necessary to retain current carrying parts in position
Burning behaviour	Glow wire test IEC 60 695-2-11: 960 °C UL Subject 94: V-0 flame-retardant self-extinguishing

"weatherproof", for outdoor installation

	<p><b>KF 0600 G</b></p>				
					

Degree of protection against mechanical load

IK09 (10 Joule)

Toxic behaviour

halogen-free  
silicone-free  
"halogen-free" in accordance with the examination of the cables and insulated wires - corrosiveness of fumes - as per IEC 60 754-2

Note:

For material properties see technical data.