



RS621S, RS622S
RS621, RS622, RS624

7MHz, Rail-to-Rail I/O CMOS Operational Amplifier

FEATURES

- **HIGH GAIN BANDWIDTH: 7MHz**
- **RAIL-TO-RAIL INPUT AND OUTPUT**
0.7mV Typical Vos
- **INPUT VOLTAGE RANGE: -0.1V to +5.6V**
with $V_s = 5.5V$
- **SUPPLY RANGE: +2.5V to +5.5V**
- **SHUTDOWN: RS621S/RS622S**
- **SPECIFIED UP TO +125°C**
- **Micro SIZE PACKAGES: SOT23-5, SOT23-6**

APPLICATIONS

- **SENSORS**
- **PHOTODIODE AMPLIFICATION**
- **ACTIVE FILTERS**
- **TEST EQUIPMENT**
- **DRIVING A/D CONVERTERS**

DESCRIPTION

The RS62X families of products offer low voltage operation and rail-to-rail input and output, as well as excellent speed/power consumption ratio, providing an excellent bandwidth (7MHz) and slew rate of 3.7V/us. The op-amps are unity gain stable and feature an ultra-low input bias current.

The devices are ideal for sensor interfaces, active filters and portable applications. The RS621S, RS622S include a shutdown mode. Under logic control, the amplifiers can be switched from normal operation to a standby current that is less than 1uA. The RS62X families of operational amplifiers are specified at the full temperature range of $-40^{\circ}C$ to $+125^{\circ}C$ under single or dual power supplies of 2.5V to 5.5V.

PIN CONFIGURATIONS

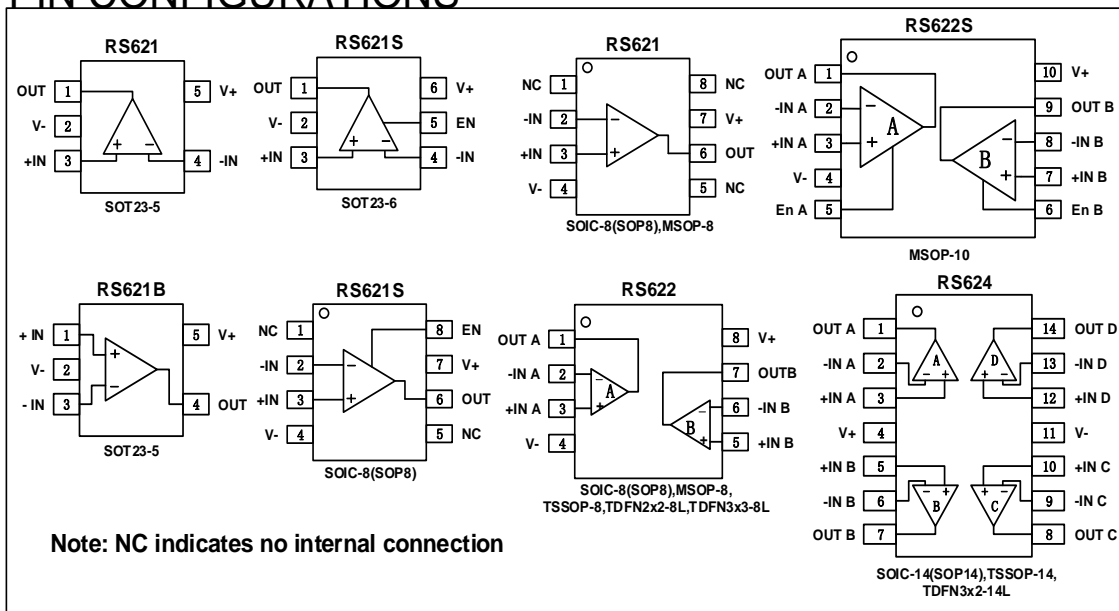

ABSOLUTE MAXIMUM RATINGS ⁽¹⁾

| | |
|---|----------------------|
| Supply Voltage, V+ to V-..... | 7.0V |
| Input Terminals, Voltage ⁽²⁾ | - 0.5 to (V+) + 0.5V |
| Current ⁽²⁾ | ±10mA |
| Storage Temperature | -65°C to +150°C |
| Operating Temperature | -40°C to +125°C |
| Junction Temperature..... | 150°C |
| Package Thermal Resistance @ T _A = +25°C | |
| SOT23-5, SOT23-6..... | 200°C/W |
| MSOP-10, SOIC-8, TSSOP-8..... | 150°C/W |
| SOIC-14, TSSOP-14..... | 100°C/W |
| Lead Temperature (Soldering, 10s) | 260°C |
| ESD Susceptibility | |
| HBM | 5000V |
| MM | 400V |



ESD SENSITIVITY CAUTION

ESD damage can range from subtle performance degradation to complete device failure. Precision integrated circuits may be more susceptible to damage because very small parametric changes could cause the device not to meet its published specifications.

- (1) Stresses above these ratings may cause permanent damage. Exposure to absolute maximum conditions for extended periods may degrade device reliability. These are stress ratings only, and functional operation of the device at these or any other conditions beyond those specified is not implied.
- (2) Input terminals are diode-clamped to the power-supply rails. Input signals that can swing more than 0.5V beyond the supply rails should be current-limited to 10mA or less.

PACKAGE/ORDERING INFORMATION

| PRODUCT | ORDERING NUMBER | TEMPERATURE RANGE | PACKAGE LEAD | PACKAGE MARKING | PACKAGE OPTION |
|---------|-----------------|-------------------|----------------|-----------------|--------------------|
| RS621 | RS621XK | -40°C~125°C | SOIC-8(SOP8) | RS621 | Tape and Reel,2500 |
| | RS621XF | -40°C~125°C | SOT23-5 | 621 | Tape and Reel,3000 |
| | RS621BXF | -40°C~125°C | SOT23-5 | 621B | Tape and Reel,3000 |
| | RS621XM | -40°C~125°C | MSOP-8 | RS621 | Tape and Reel,3000 |
| RS621S | RS621SXK | -40°C~125°C | SOIC-8(SOP8) | RS621S | Tape and Reel,2500 |
| | RS621SXH | -40°C~125°C | SOT23-6 | 621S | Tape and Reel,3000 |
| RS622 | RS622XK | -40°C~125°C | SOIC-8(SOP8) | RS622 | Tape and Reel,2500 |
| | RS622XM | -40°C~125°C | MSOP-8 | RS622 | Tape and Reel,3000 |
| | RS622XTDE8 | -40°C~125°C | TDFN2x2-8L | RS622 | Tape and Reel,3000 |
| | RS622XTDC8 | -40°C~125°C | TDFN3x3-8L | RS622 | Tape and Reel,3000 |
| | RS622XQ | -40°C~125°C | TSSOP-8 | RS622 | Tape and Reel,3000 |
| RS622S | RS622SXN | -40°C~125°C | MSOP-10 | RS622S | Tape and Reel,3000 |
| RS624 | RS624XP | -40°C~125°C | SOIC-14(SOP14) | RS624 | Tape and Reel,2500 |
| | RS624XQ | -40°C~125°C | TSSOP-14 | RS624 | Tape and Reel,3000 |
| | RS624XTDB14 | -40°C~125°C | TDFN3x2-14L | RS624 | Tape and Reel,3000 |



ELECTRICAL CHARACTERISTICS

(At $T_A = +25^{\circ}\text{C}$, $V_S = 5\text{V}$, $R_L = 10\text{k}\Omega$ connected to $V_S/2$, and $V_{OUT} = V_S/2$, unless otherwise noted.)

| PARAMETER | | CONDITIONS | T_J | RS621S, RS622S, RS621, RS622, RS624 | | | UNIT |
|---------------------------------------|------------------------------------|---|---|--|-----|---------------|--------------------------------|
| | | | | MIN | TYP | MAX | |
| POWER SUPPLY | | | | | | | |
| V_S | Operating Voltage Range | | 25°C | 2.5 | | 5.5 | V |
| I_Q | Quiescent Current/Amplifier | | 25°C | | 600 | 800 | μA |
| PSRR | Power-Supply Rejection Ratio | $V_S = 2.5\text{V to } 5.5\text{V}$, $V_{cm} = (V_-) + 0.5\text{V}$ | 25°C | 78 | 93 | | dB |
| | | | $-40^{\circ}\text{C to } 125^{\circ}\text{C}$ | 72 | | | |
| INPUT | | | | | | | |
| V_{os} | Input Offset Voltage | | 25°C | | 0.7 | 3 | mV |
| $V_{os\ TC}$ | Input Offset Voltage Average Drift | $-40^{\circ}\text{C to } 125^{\circ}\text{C}$ | | | 2 | | $\mu\text{V}/^{\circ}\text{C}$ |
| I_B | Input Bias Current | | 25°C | | 1 | 10 | pA |
| I_{os} | Input Offset Current | | 25°C | | 1 | 10 | pA |
| V_{cm} | Common-Mode Voltage Range | $V_S = 5.5\text{V}$ | 25°C | -0.1 | | 5.6 | V |
| CMRR | Common-Mode Rejection Ratio | $V_S = 5.5\text{V}$, $V_{cm} = -0.1\text{V to } 4\text{V}$ | 25°C | 74 | 92 | | dB |
| | | | $-40^{\circ}\text{C to } 125^{\circ}\text{C}$ | 68 | | | |
| | | | 25°C | 62 | 83 | | |
| | | | $-40^{\circ}\text{C to } 125^{\circ}\text{C}$ | 60 | | | |
| OUTPUT | | | | | | | |
| AOL | Open-Loop Voltage Gain | $R_L = 2\text{k}\Omega$, $V_o = 0.15\text{V to } 4.85\text{V}$ | 25°C | 96 | 102 | | dB |
| | | | $-40^{\circ}\text{C to } 125^{\circ}\text{C}$ | 83 | | | |
| | | | 25°C | 98 | 106 | | |
| | | | $-40^{\circ}\text{C to } 125^{\circ}\text{C}$ | 85 | | | |
| | Output Swing From Rail | $R_L = 2\text{k}\Omega$ $R_L = 10\text{k}\Omega$ | 25°C | | 40 | | mV |
| | | | | | 7 | | |
| I_{out} | Output Short-Circuit Current | | 25°C | | 50 | | mA |
| FREQUENCY RESPONSE | | | | | | | |
| SR | Slew Rate | | 25°C | | 3.7 | | V/ μs |
| GBP | Gain-Bandwidth Product | | 25°C | | 7 | | MHz |
| PM | Phase Margin | | 25°C | | 64 | | $^{\circ}$ |
| t_s | Setting Time, 0.1% | | | | 0.5 | | μs |
| | Overload Recovery Time | $V_{IN} \cdot \text{Gain} \geq V_S$ | | | 0.5 | | μs |
| NOISE | | | | | | | |
| e_n | Input Voltage Noise Density | $f = 1\text{KHz}$ | 25°C | | 11 | | $\text{nV}/\sqrt{\text{Hz}}$ |
| | | $f = 10\text{KHz}$ | 25°C | | 7.5 | | $\text{nV}/\sqrt{\text{Hz}}$ |
| ENABLE/SHUTDOWN(RS621S,RS622S) | | | | | | | |
| $I_{Q(OFF)}$ | Supply Current in Shutdown | | 25°C | | <1 | | μA |
| t_{OFF} | | | 25°C | | 3 | | μs |
| t_{ON} | | | 25°C | | 20 | | μs |
| V_L | Shut Down | | 25°C | V_- | | $(V_-) + 0.8$ | V |
| V_H | Amplifier Is Active | | 25°C | $(V_-) + 2$ | | V_+ | V |

TYPICAL CHARACTERISTICS

At $T_A = +25^\circ\text{C}$, $V_S = 5\text{V}$, $R_L = 10\text{k}\Omega$ connected to $V_S/2$, $V_{OUT} = V_S/2$, unless otherwise noted.

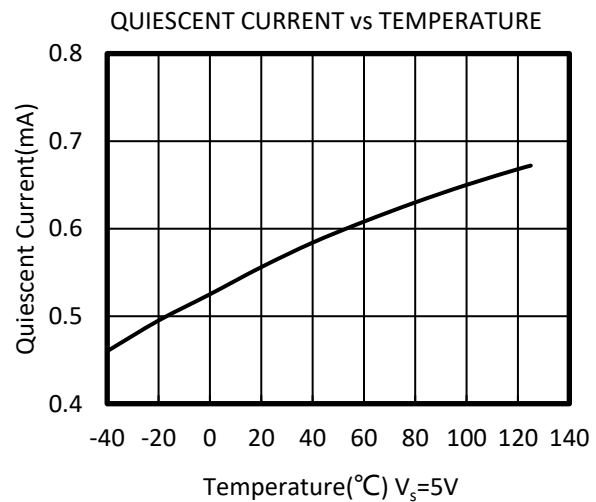
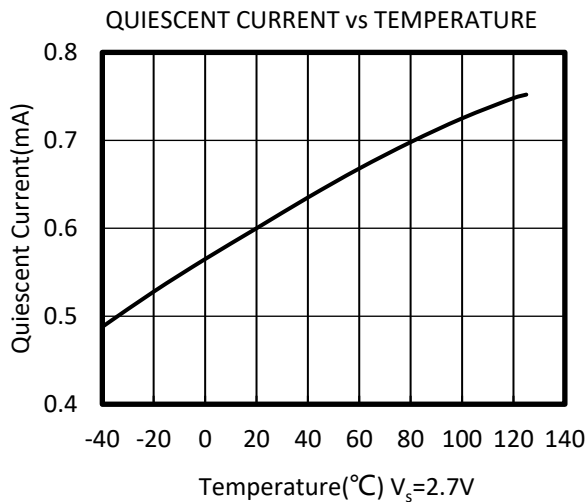
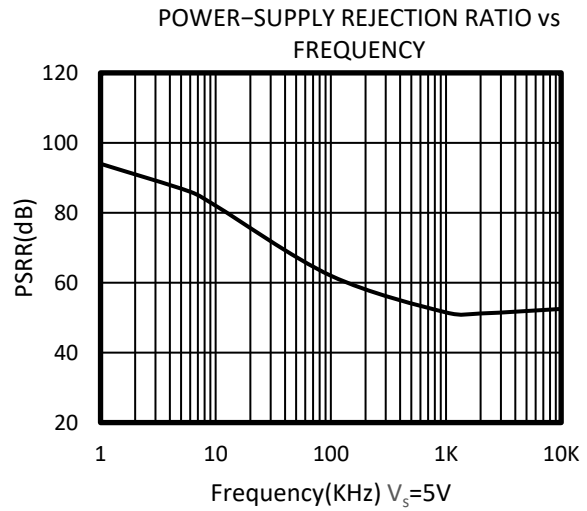
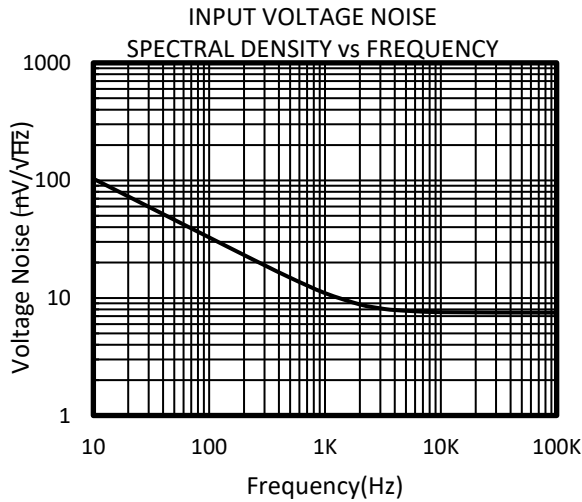
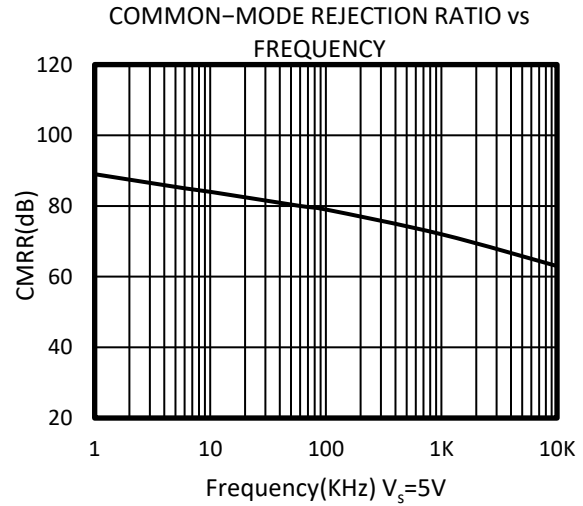
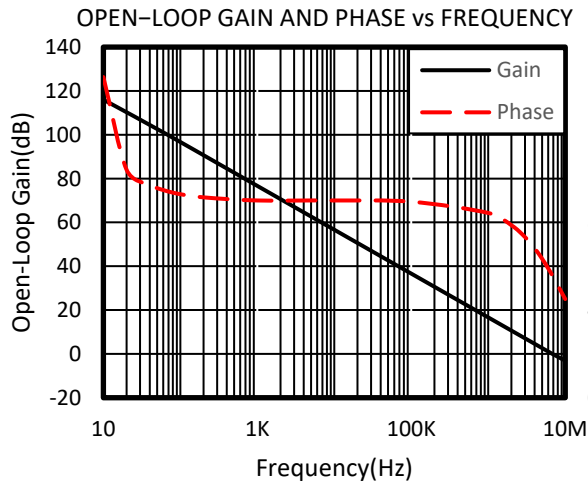



TYPICAL CHARACTERISTICS

At $T_A = +25^\circ\text{C}$, $V_S=5\text{V}$, $R_L = 10\text{k}\Omega$ connected to $V_S/2$, $V_{OUT} = V_S/2$, unless otherwise noted.

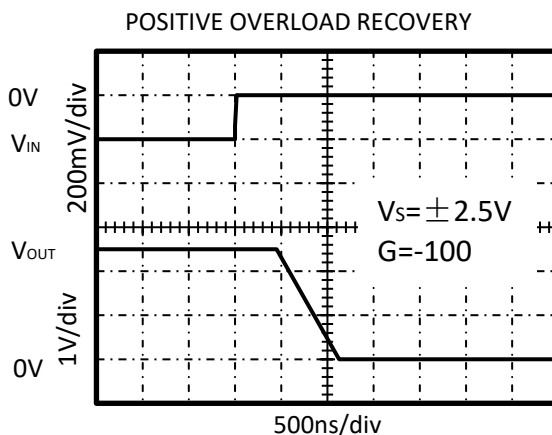
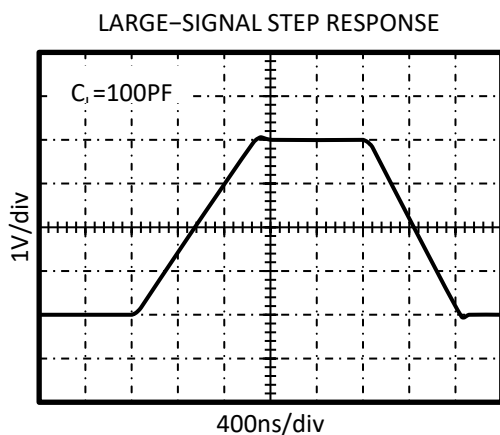
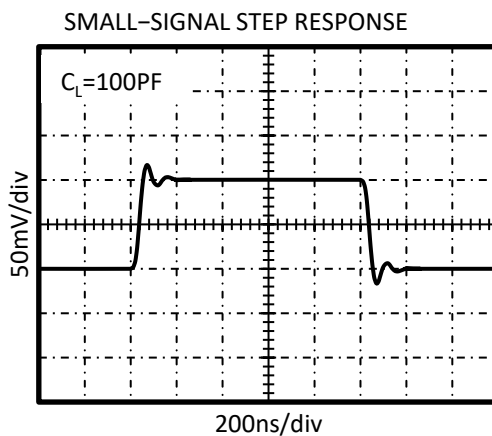
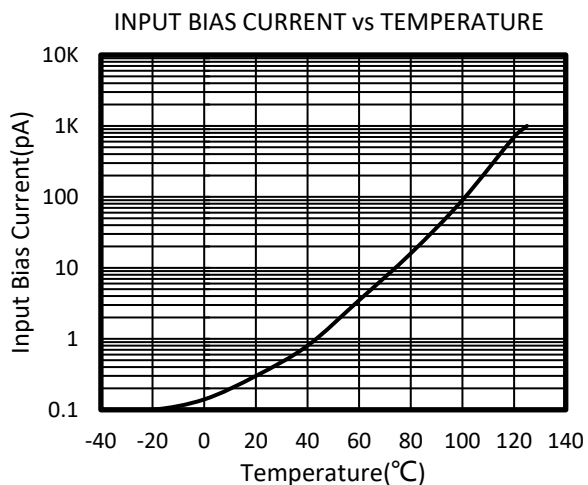
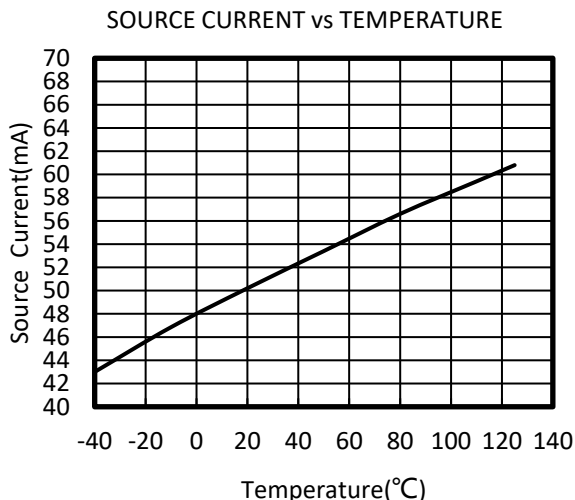
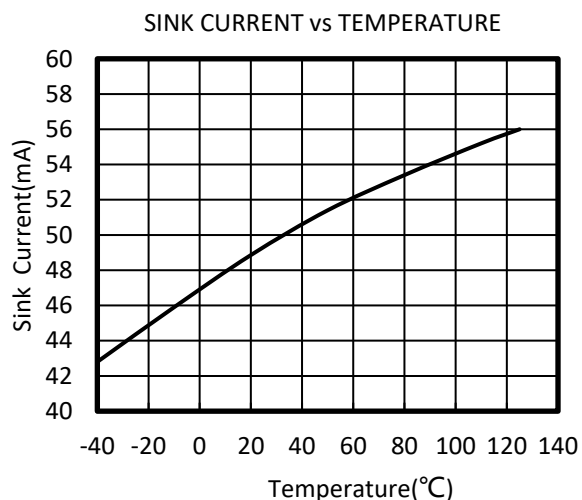

TYPICAL CHARACTERISTICS

At $T_A = +25^\circ\text{C}$, $V_S = 5\text{V}$, $R_L = 10\text{k}\Omega$ connected to $V_S/2$, $V_{OUT} = V_S/2$, unless otherwise noted.

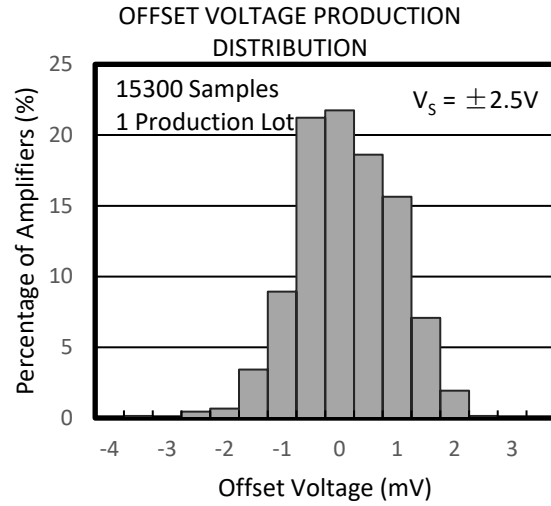
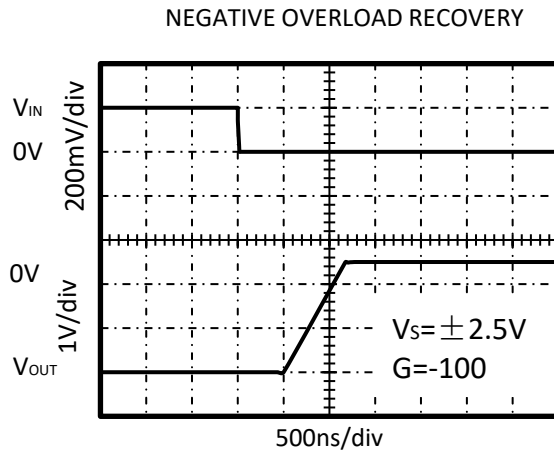

APPLICATION NOTES

The RS621, RS622, RS624, RS621S, RS622S are high precision, rail-to-rail operational amplifiers that can be run from a single-supply voltage 2.5V to 5.5V ($\pm 1.25V$ to $\pm 2.75V$). Supply voltages higher than 7V (absolute maximum) can permanently damage the amplifier.

Rail-to-rail input and output swing significantly increases dynamic range, especially in low-supply applications.

Good layout practice mandates use of a 0.1uF capacitor place closely across the supply pins.

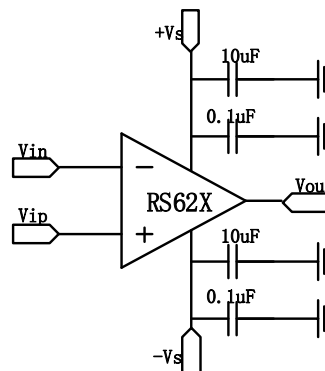

Figure1. Amplifier with Bypass Capacitors

RS621S/RS622S ENABLE FUNCTION

The RS621S/RS622S includes a shutdown mode. Under logic control, the amplifiers can be switched from normal mode to a standby current of 1uA. When the Enable pin is connected to high, the amplifier is active. Connecting Enable low disables the amplifier, and places the amplifier, and place the output in a high-impedance state.

LAYOUT GUIDELINS

Attention to good layout practices is always recommended. Keep traces short. When possible, use a PCB ground plane with surface-mount components placed as close to the device pins as possible. Place a 0.1uF capacitor closely across the supply pins.

These guidelines should be applied throughout the analog circuit to improve performance and provide benefits such as reducing the EMI susceptibility.

INSTRUMENTATION AMPLIFIER

In the three-op amp, instrumentation amplifier configuration shown in Figure2,

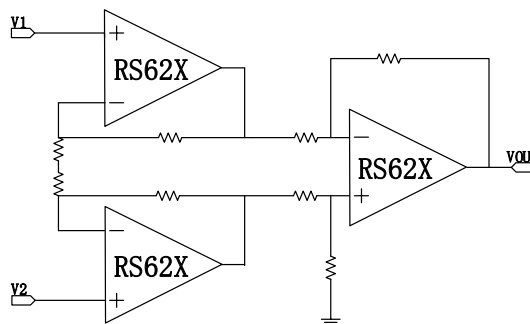
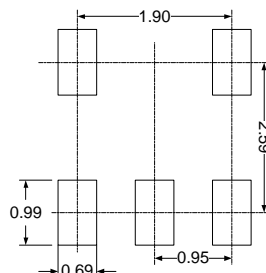
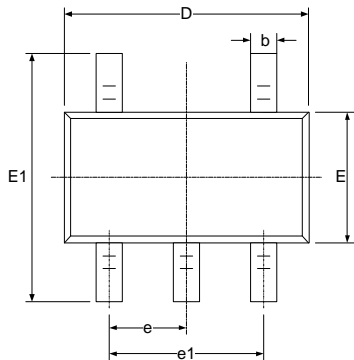

Figure2. Amplifier instrumentation amplifier

PACKAGE OUTLINE DIMENSIONS

SOT23-5



RECOMMENDED LAND PATTERN (Unit: mm)

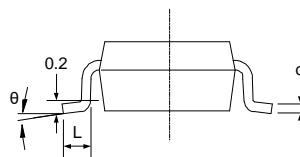
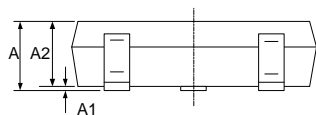

| Symbol | Dimensions In Millimeters | | Dimensions In Inches | |
|--------|---------------------------|-------|----------------------|-------|
| | Min | Max | Min | Max |
| A | 1.050 | 1.250 | 0.041 | 0.049 |
| A1 | 0.000 | 0.100 | 0.000 | 0.004 |
| A2 | 1.050 | 1.150 | 0.041 | 0.045 |
| b | 0.300 | 0.500 | 0.012 | 0.020 |
| c | 0.100 | 0.200 | 0.004 | 0.008 |
| D | 2.820 | 3.020 | 0.111 | 0.119 |
| E | 1.500 | 1.700 | 0.059 | 0.067 |
| E1 | 2.650 | 2.950 | 0.104 | 0.116 |
| e | 0.950(BSC) | | 0.037(BSC) | |
| e1 | 1.800 | 2.000 | 0.071 | 0.079 |
| L | 0.300 | 0.600 | 0.012 | 0.024 |
| θ | 0° | 8° | 0° | 8° |

SOT23-6

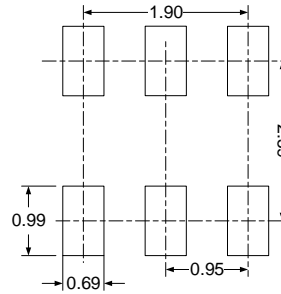
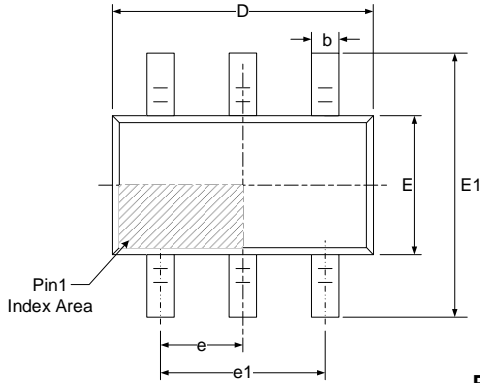

RECOMMENDED LAND PATTERN (Unit: mm)

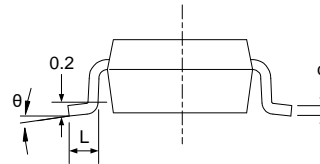
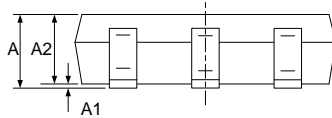

| Symbol | Dimensions In Millimeters | | Dimensions In Inches | |
|----------|---------------------------|-------|----------------------|-------|
| | Min | Max | Min | Max |
| A | 1.050 | 1.250 | 0.041 | 0.049 |
| A1 | 0.000 | 0.100 | 0.000 | 0.004 |
| A2 | 1.050 | 1.150 | 0.041 | 0.045 |
| b | 0.300 | 0.500 | 0.012 | 0.020 |
| c | 0.100 | 0.200 | 0.004 | 0.008 |
| D | 2.820 | 3.020 | 0.111 | 0.119 |
| E | 1.500 | 1.700 | 0.059 | 0.067 |
| E1 | 2.650 | 2.950 | 0.104 | 0.116 |
| e | 0.950(BSC) | | 0.037(BSC) | |
| e1 | 1.800 | 2.000 | 0.071 | 0.079 |
| L | 0.300 | 0.600 | 0.012 | 0.024 |
| θ | 0° | 8° | 0° | 8° |

MSOP-8

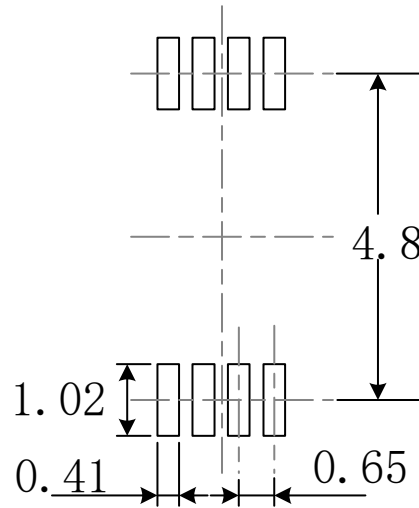
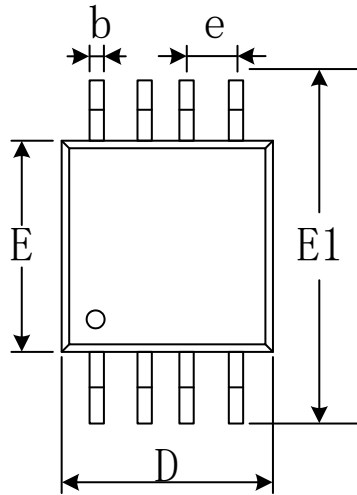

RECOMMENDED LAND PATTERN (Unit: mm)

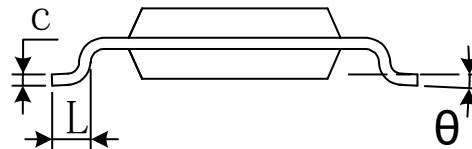
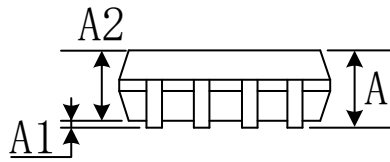

| Symbol | Dimensions In Millimeters | | Dimensions In Inches | |
|----------|---------------------------|-------|----------------------|-------|
| | Min | Max | Min | Max |
| A | 0.820 | 1.100 | 0.032 | 0.043 |
| A1 | 0.020 | 0.150 | 0.001 | 0.006 |
| A2 | 0.750 | 0.950 | 0.030 | 0.037 |
| b | 0.250 | 0.380 | 0.010 | 0.015 |
| c | 0.090 | 0.230 | 0.004 | 0.009 |
| D | 2.900 | 3.100 | 0.114 | 0.122 |
| e | 0.650(BSC) | | 0.026(BSC) | |
| E | 2.900 | 3.100 | 0.114 | 0.122 |
| E1 | 4.750 | 5.050 | 0.187 | 0.199 |
| L | 0.400 | 0.800 | 0.016 | 0.031 |
| θ | 0° | 6° | 0° | 6° |

MSOP-10

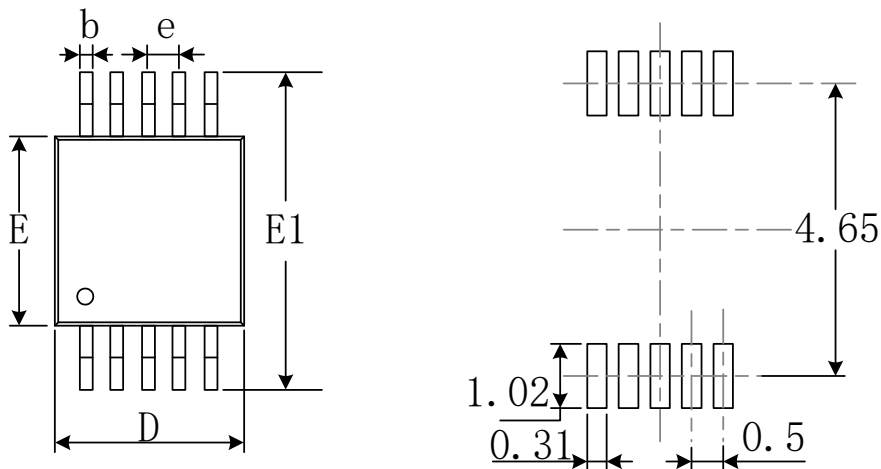

RECOMMENDED LAND PATTERN (Unit: mm)

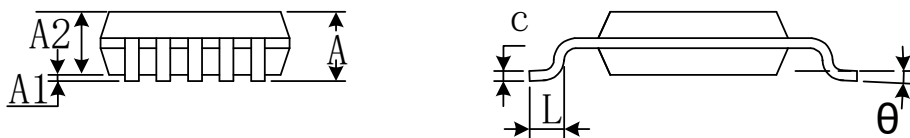

| Symbol | Dimensions In Millimeters | | Dimensions In Inches | |
|--------|---------------------------|-------|----------------------|-------|
| | Min | Max | Min | Max |
| A | 0.820 | 1.100 | 0.032 | 0.043 |
| A1 | 0.020 | 0.150 | 0.001 | 0.006 |
| A2 | 0.750 | 0.950 | 0.030 | 0.037 |
| b | 0.180 | 0.280 | 0.007 | 0.011 |
| c | 0.090 | 0.230 | 0.004 | 0.009 |
| D | 2.900 | 3.100 | 0.114 | 0.122 |
| e | 0.50(BSC) | | 0.020(BSC) | |
| E | 2.900 | 3.100 | 0.114 | 0.122 |
| E1 | 4.750 | 5.050 | 0.187 | 0.199 |
| L | 0.400 | 0.800 | 0.016 | 0.031 |
| θ | 0° | 6° | 0° | 6° |

TSSOP-8

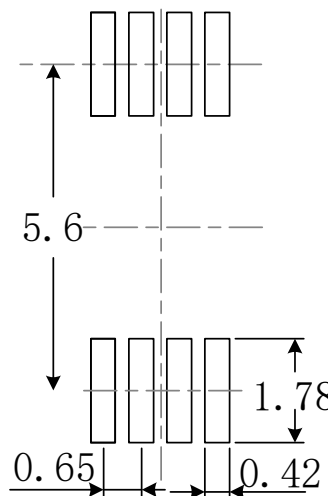
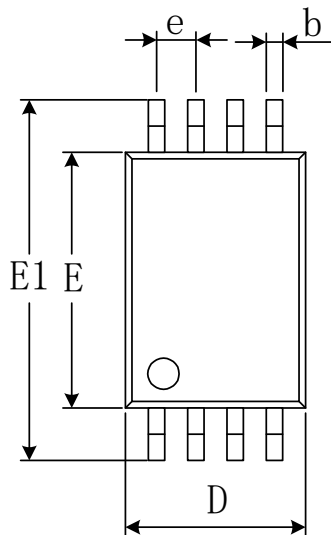

RECOMMENDED LAND PATTERN (Unit: mm)

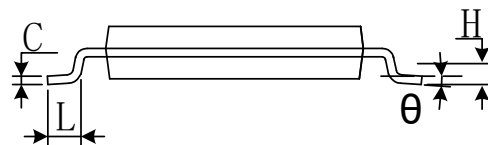
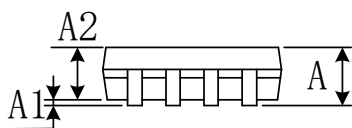

| Symbol | Dimensions In Millimeters | | Dimensions In Inches | |
|----------|---------------------------|-------|----------------------|-------|
| | Min | Max | Min | Max |
| A | | 1.200 | | 0.047 |
| A1 | 0.050 | 0.150 | 0.002 | 0.006 |
| A2 | 0.800 | 1.050 | 0.031 | 0.041 |
| b | 0.190 | 0.300 | 0.007 | 0.012 |
| c | 0.090 | 0.200 | 0.004 | 0.008 |
| D | 2.900 | 3.100 | 0.114 | 0.122 |
| E | 4.300 | 4.500 | 0.169 | 0.177 |
| E1 | 6.250 | 6.550 | 0.246 | 0.258 |
| e | 0.650(BSC) | | 0.026(BSC) | |
| L | 0.500 | 0.700 | 0.020 | 0.028 |
| H | 0.25(TYP) | | 0.01(TYP) | |
| θ | 1° | 7° | 1° | 7° |

TSSOP-14

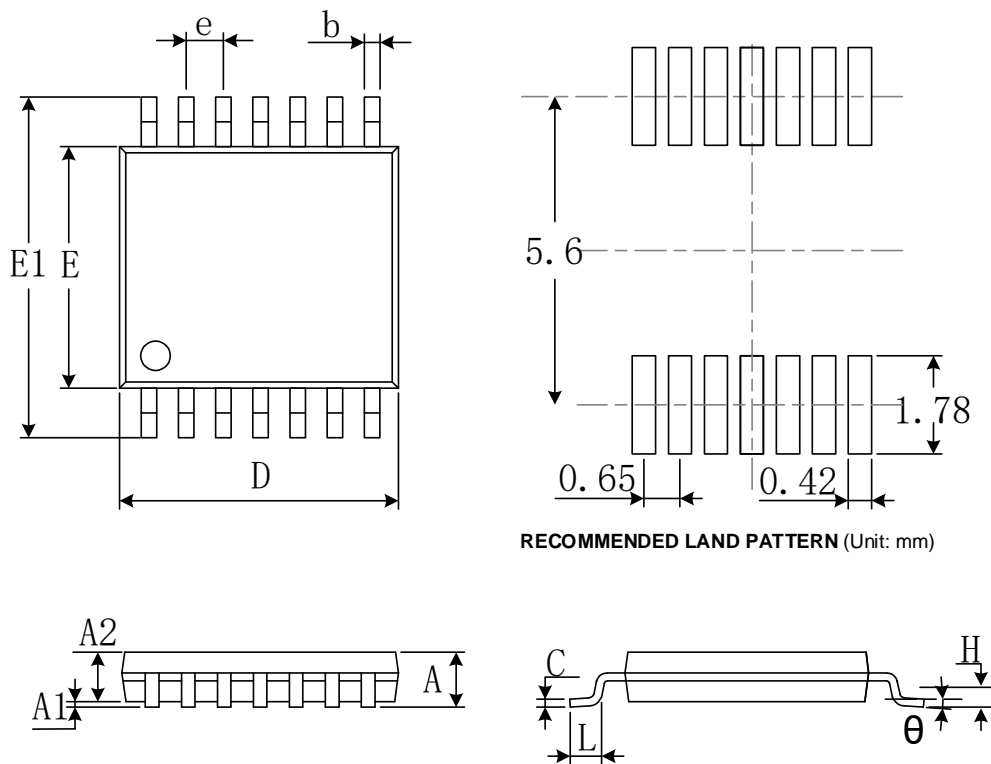

RECOMMENDED LAND PATTERN (Unit: mm)

| Symbol | Dimensions In Millimeters | | Dimensions In Inches | |
|----------|---------------------------|-------|----------------------|-------|
| | Min | Max | Min | Max |
| A | | 1.200 | | 0.047 |
| A1 | 0.050 | 0.150 | 0.002 | 0.006 |
| A2 | 0.800 | 1.050 | 0.031 | 0.041 |
| b | 0.190 | 0.300 | 0.007 | 0.012 |
| c | 0.090 | 0.200 | 0.004 | 0.008 |
| D | 4.860 | 5.100 | 0.191 | 0.201 |
| E | 4.300 | 4.500 | 0.169 | 0.177 |
| E1 | 6.250 | 6.550 | 0.246 | 0.258 |
| e | 0.650(BSC) | | 0.026(BSC) | |
| L | 0.500 | 0.700 | 0.020 | 0.028 |
| H | 0.25(TYP) | | 0.01(TYP) | |
| θ | 1° | 7° | 1° | 7° |

SOIC-8(SOP8)

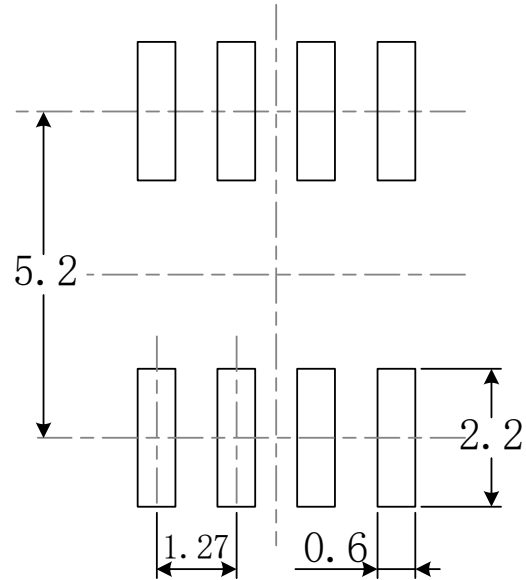
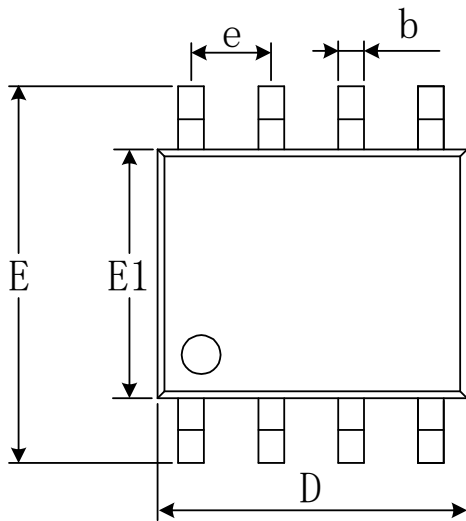

RECOMMENDED LAND PATTERN (Unit: mm)

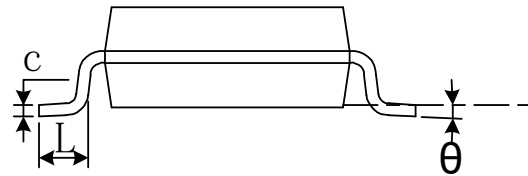
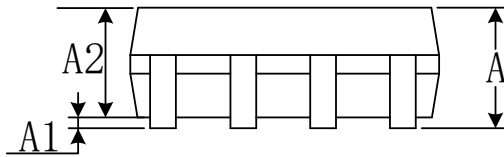

| Symbol | Dimensions In Millimeters | | Dimensions In Inches | |
|----------|---------------------------|-------|----------------------|-------|
| | Min | Max | Min | Max |
| A | 1.350 | 1.750 | 0.053 | 0.069 |
| A1 | 0.100 | 0.250 | 0.004 | 0.010 |
| A2 | 1.350 | 1.550 | 0.053 | 0.061 |
| b | 0.330 | 0.510 | 0.013 | 0.020 |
| c | 0.170 | 0.250 | 0.007 | 0.010 |
| D | 4.800 | 5.000 | 0.189 | 0.197 |
| e | 1.270(BSC) | | 0.050(BSC) | |
| E | 5.800 | 6.200 | 0.228 | 0.244 |
| E1 | 3.800 | 4.000 | 0.150 | 0.157 |
| L | 0.400 | 1.270 | 0.016 | 0.050 |
| θ | 0° | 8° | 0° | 8° |

SOIC-14(SOP14)

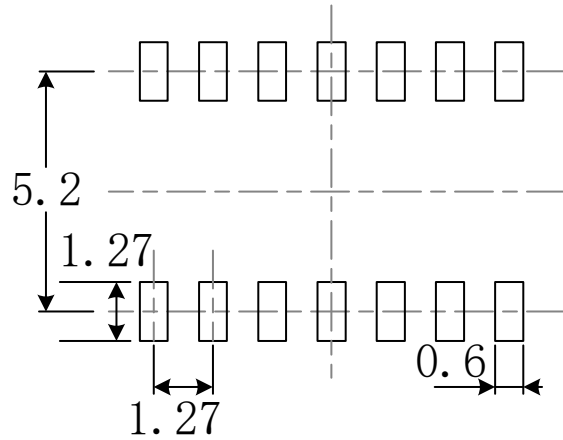
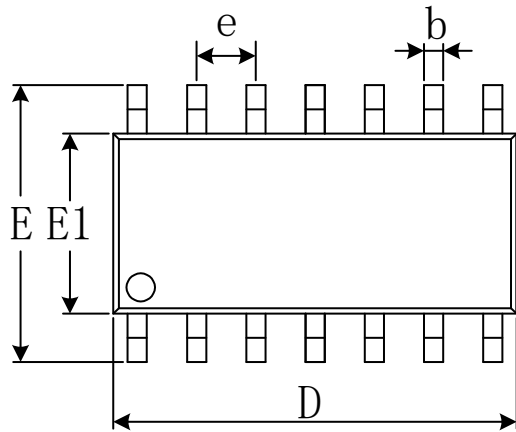

RECOMMENDED LAND PATTERN (Unit: mm)

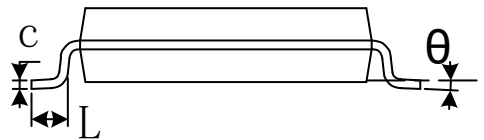
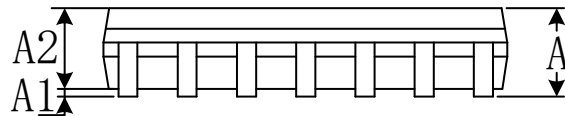

| Symbol | Dimensions In Millimeters | | Dimensions In Inches | |
|----------|---------------------------|-------|----------------------|-------|
| | Min | Max | Min | Max |
| A | 1.350 | 1.750 | 0.053 | 0.069 |
| A1 | 0.100 | 0.250 | 0.004 | 0.010 |
| A2 | 1.350 | 1.550 | 0.053 | 0.061 |
| b | 0.310 | 0.510 | 0.012 | 0.020 |
| c | 0.100 | 0.250 | 0.004 | 0.010 |
| D | 8.450 | 8.850 | 0.333 | 0.348 |
| e | 1.270(BSC) | | 0.050(BSC) | |
| E | 5.800 | 6.200 | 0.228 | 0.244 |
| E1 | 3.800 | 4.000 | 0.150 | 0.157 |
| L | 0.400 | 1.270 | 0.016 | 0.050 |
| θ | 0° | 8° | 0° | 8° |

TDFN-2x2-8L

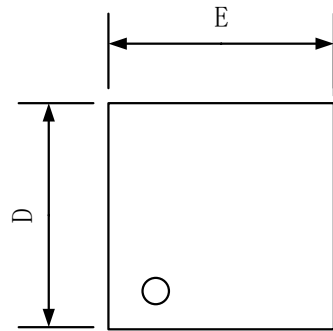

TOP VIEW

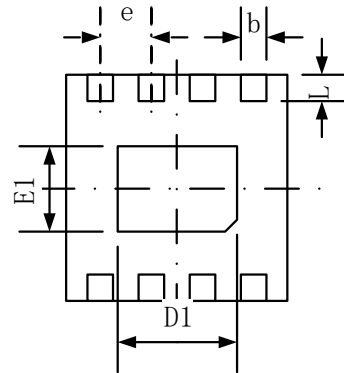

BOTTOM VIEW

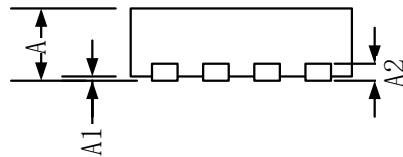

SIDE VIEW

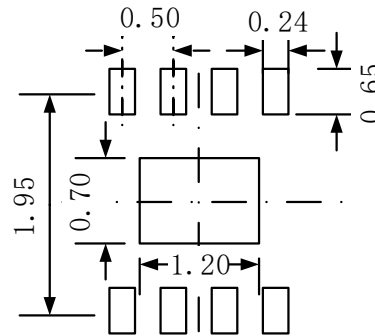

RECOMMENDED LAND PATTERN (Unit: mm)

| Symbol | Dimensions In Millimeters | | Dimensions In Inches | |
|--------|---------------------------|-------|----------------------|-------|
| | Min | Max | Min | Max |
| A | 0.700 | 0.800 | 0.028 | 0.031 |
| A1 | 0.000 | 0.050 | 0.000 | 0.002 |
| A2 | 0.203(TYP) | | 0.008(TYP) | |
| b | 0.180 | 0.300 | 0.007 | 0.012 |
| D | 1.900 | 2.100 | 0.075 | 0.083 |
| D1 | 1.100 | 1.300 | 0.043 | 0.051 |
| E | 1.900 | 2.100 | 0.075 | 0.083 |
| E1 | 0.600 | 0.800 | 0.024 | 0.031 |
| e | 0.500(TYP) | | 0.020(TYP) | |
| L | 0.250 | 0.450 | 0.010 | 0.018 |

TDFN-3x3-8L

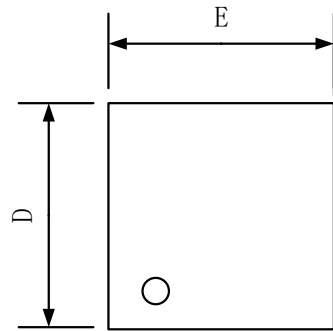

TOP VIEW

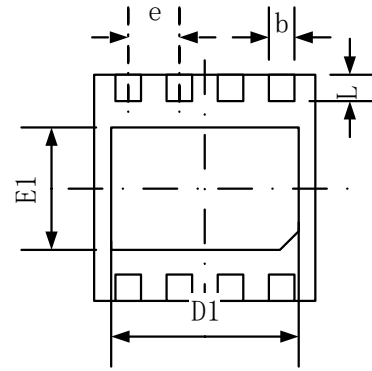

BOTTOM VIEW

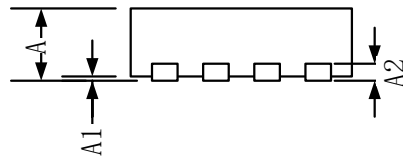

SIDE VIEW

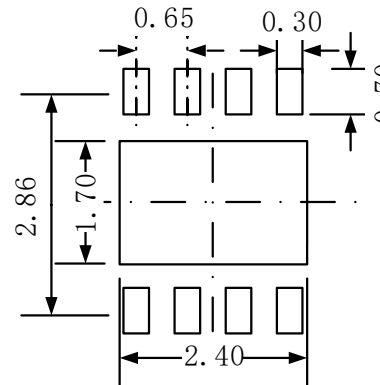

RECOMMENDED LAND PATTERN (Unit: mm)

| Symbol | Dimensions In Millimeters | | Dimensions In Inches | |
|--------|---------------------------|-------|----------------------|-------|
| | Min | Max | Min | Max |
| A | 0.700 | 0.800 | 0.028 | 0.031 |
| A1 | 0.000 | 0.050 | 0.000 | 0.002 |
| A2 | 0.203 | | 0.008 | |
| b | 0.250 | 0.350 | 0.010 | 0.014 |
| D | 2.900 | 3.100 | 0.114 | 0.122 |
| D1 | 2.350 | 2.450 | 0.093 | 0.096 |
| E | 2.900 | 3.100 | 0.114 | 0.122 |
| E1 | 1.650 | 1.750 | 0.065 | 0.069 |
| e | 0.650 TYP | | 0.026 TYP | |
| L | 0.370 | 0.470 | 0.015 | 0.019 |

TDFN-3x2-14L

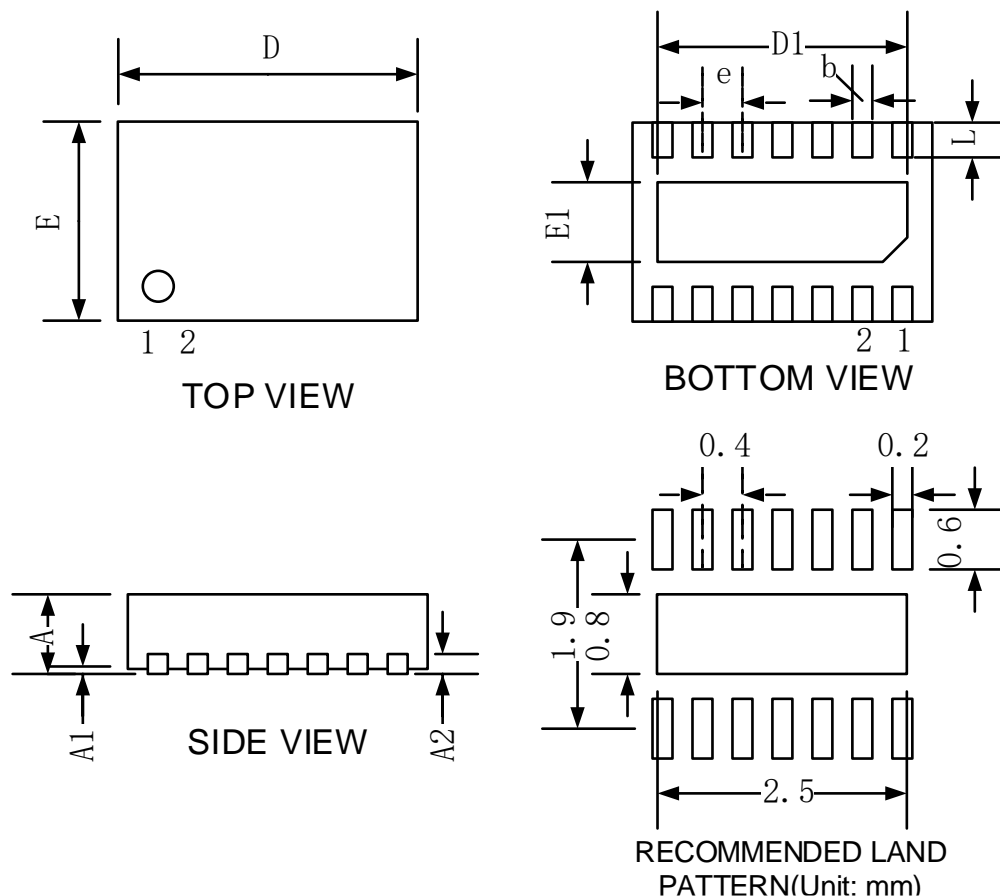

| Symbol | Dimensions In Millimeters | | Dimensions In Inches | |
|--------|---------------------------|-------|----------------------|-------|
| | Min | Max | Min | Max |
| A | 0.700 | 0.800 | 0.028 | 0.031 |
| A1 | 0.000 | 0.050 | 0.000 | 0.002 |
| A2 | 0.200 | | 0.008 | |
| b | 0.150 | 0.250 | 0.006 | 0.010 |
| D | 2.900 | 3.100 | 0.114 | 0.122 |
| D1 | 2.400 | 2.600 | 0.094 | 0.102 |
| E | 1.900 | 2.100 | 0.075 | 0.083 |
| E1 | 0.700 | 0.900 | 0.028 | 0.035 |
| e | 0.400 TYP | | 0.016 TYP | |
| L | 0.300 | 0.400 | 0.012 | 0.016 |