

## SC-15-35JH

Aliases (UALSC1535JH000)

KEMET, SC-JH, AC Line Filters, Common Mode, 3.5 mH

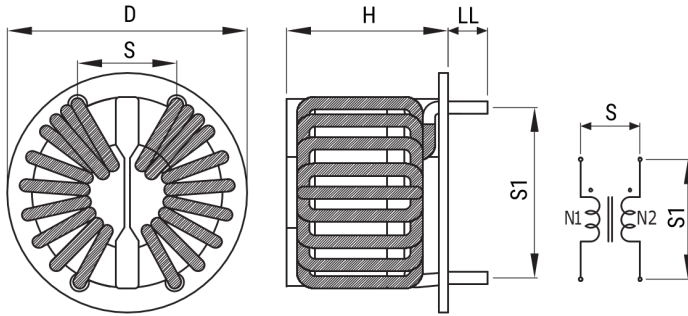

Click [here](#) for the 3D model.

### Dimensions

D	51mm MAX
H	34mm MAX
LL	5mm +/-2mm
S	15mm NOM
S1	35mm NOM
Wire Size	1.6mm

### Packaging Specifications

Packaging	Tray
Packaging Quantity	100
Component Weight	114.3 g

### General Information

Series	SC-JH
Style	Through-Hole
RoHS	Yes
Notes	Lead Spacing (S/S1) Are For Reference Only.
Miscellaneous	Temperature Rise Maximum: 80 K.
Core	Mn-Zn Ferrite

### Specifications

Voltage AC	250 VAC
Inductance	3.5 mH (1 kHz)
Current	15 A
Temperature Range	-25/+105°C
DC Resistance	20 mOhms