

High voltage power Schottky rectifier

Datasheet - production data

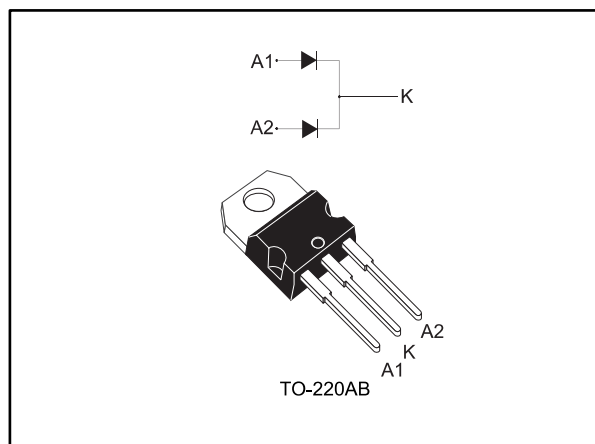

Description

This dual diode Schottky rectifier is suited for high frequency switched mode power supplies.

Packaged in TO-220AB this device is intended for use to enhance the reliability of the application.

Table 1: Device summary

Symbol	Value
$I_{F(AV)}$	2 x 30 A
V_{RRM}	170 V
T_j (max.)	175 °C
V_F (typ.)	0.76 V

Features

- High junction temperature capability
- Good trade-off between leakage current and forward voltage drop
- Low leakage current
- Low thermal resistance
- Avalanche capability specified
- High frequency operation
- ECOPACK[®]2 compliant component

1 Characteristics

Table 2: Absolute ratings (limiting values, per diode, at 25 °C, unless otherwise specified)

Symbol	Parameter		Value	Unit	
V _{RRM}	Repetitive peak reverse voltage		170	V	
I _{F(RMS)}	Forward rms current		45	A	
I _{F(AV)}	Average forward current $\delta = 0.5$, square wave	T _C = 150 °C	Per diode	30	A
			Per device	60	
I _{FSM}	Surge non repetitive forward current		t _p = 10 ms sinusoidal	270	A
P _{ARM}	Repetitive peak avalanche power		t _p = 10 μ s, T _j = 125 °C	985	W
T _{stg}	Storage temperature range		-65 to +175	°C	
T _j	Maximum operating junction temperature ⁽¹⁾		175		

Notes:

⁽¹⁾(dP_{tot}/dT_j) < (1/R_{th(j-a)}) condition to avoid thermal runaway for a diode on its own heatsink.

Table 3: Thermal parameters

Symbol	Parameter		Max. value	Unit
R _{th(j-c)}	Junction to case	Per diode	1.0	°C/W
		Total	0.7	
R _{th(c)}	Coupling		0.4	

When the diodes 1 and 2 are used simultaneously:

$$\Delta T_j (\text{diode1}) = P_{(\text{diode1})} \times R_{\text{th(j-c)}} (\text{per diode}) + P_{(\text{diode2})} \times R_{\text{th(c)}}$$

Table 4: Static electrical characteristics (per diode)

Symbol	Parameter	Test conditions		Min.	Typ.	Max.	Unit
I _R ⁽¹⁾	Reverse leakage current	T _j = 25 °C	V _R = V _{RRM}	-		35	μ A
		T _j = 125 °C		-	8	35	mA
V _F ⁽²⁾	Forward voltage drop	T _j = 25 °C	I _F = 30 A	-		0.94	V
		T _j = 125 °C		-	0.72	0.76	
		T _j = 25 °C	I _F = 60 A	-	0.97	1.05	
		T _j = 125 °C		-	0.86	0.92	

Notes:

⁽¹⁾Pulse test: t_p = 5 ms, $\delta < 2\%$

⁽²⁾Pulse test: t_p = 380 μ s, $\delta < 2\%$

To evaluate the conduction losses, use the following equation:

$$P = 0.60 \times I_{F(AV)} + 0.0053 \times I_{F(RMS)}^2$$

1.1 Characteristics (curves)

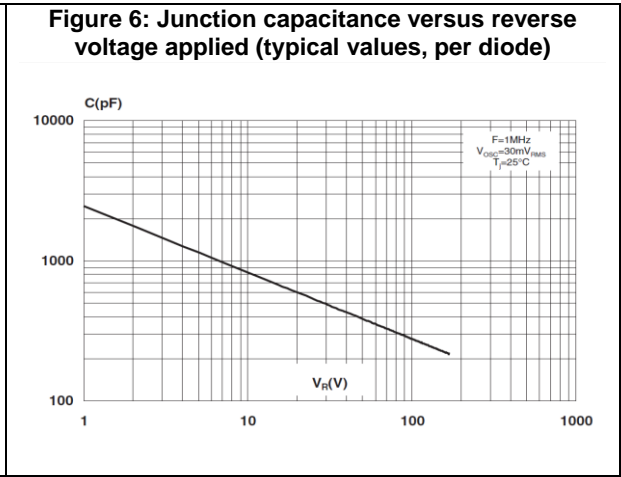
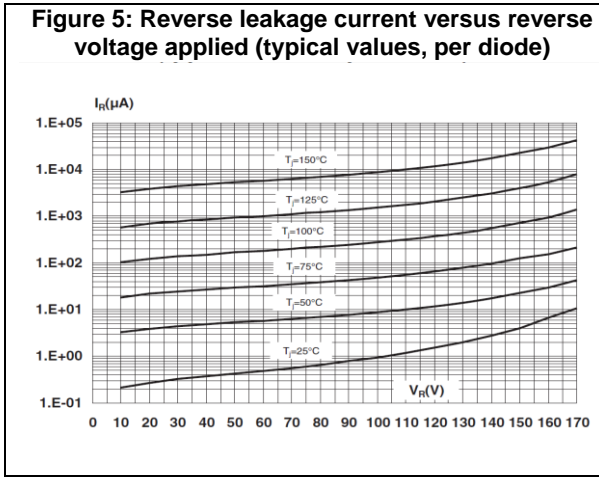
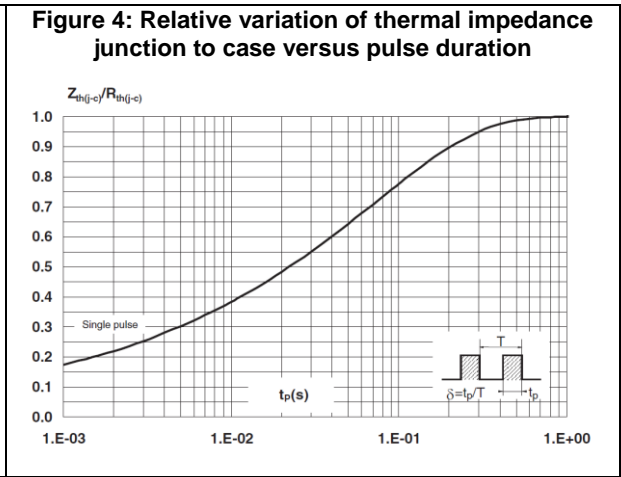
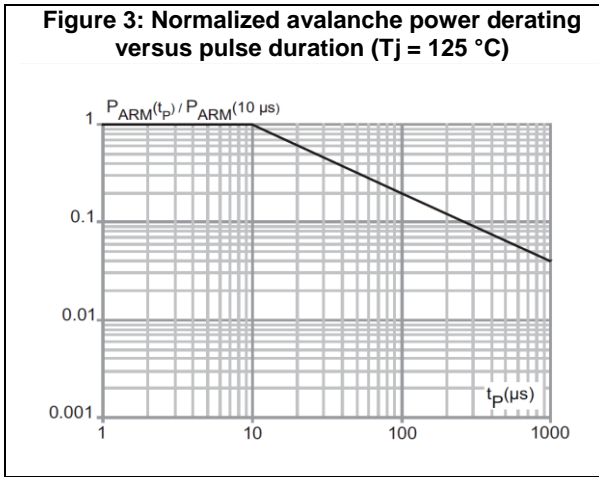
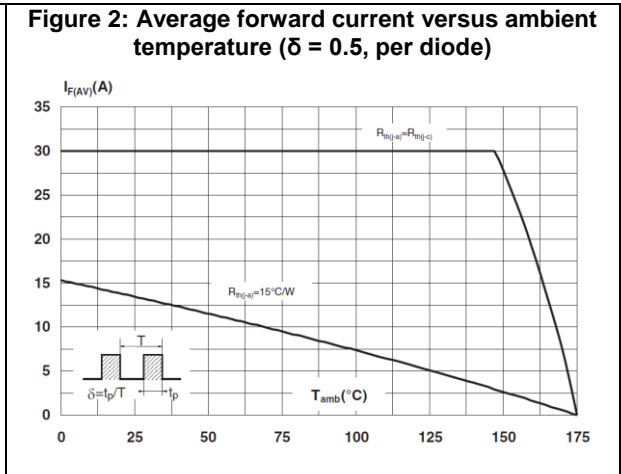
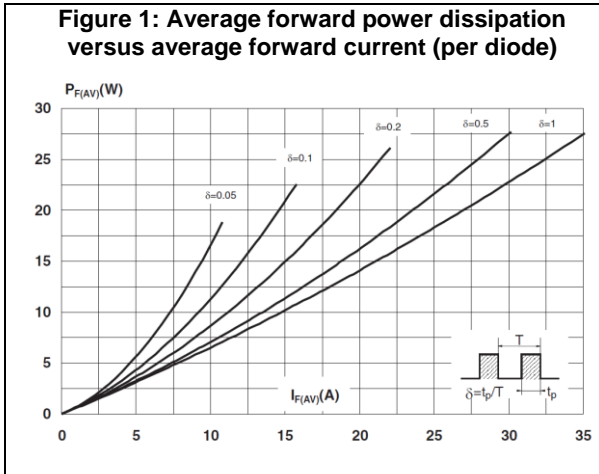

Figure 7: Forward voltage drop versus forward current (per diode, low level)

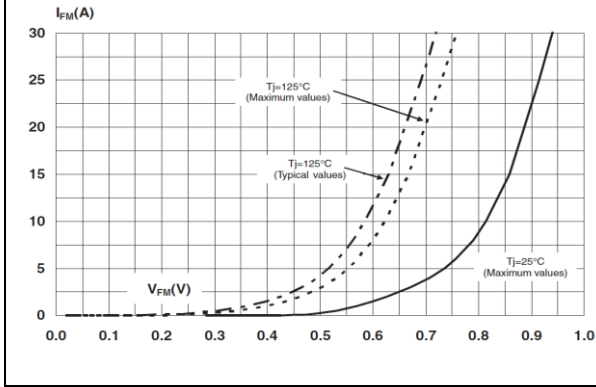
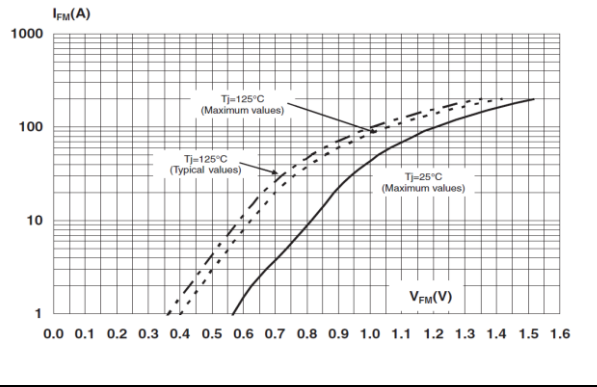

Figure 8: Forward voltage drop versus forward current (per diode, high level)



2 Package information

In order to meet environmental requirements, ST offers these devices in different grades of ECOPACK® packages, depending on their level of environmental compliance. ECOPACK® specifications, grade definitions and product status are available at: www.st.com. ECOPACK® is an ST trademark.

- Cooling method: by conduction (C)
- Epoxy meets UL 94,V0
- Recommended torque value: 0.55 N·m
- Maximum torque value: 0.7 N·m

2.1 TO-220AB package information

Figure 9: TO-220AB package outline

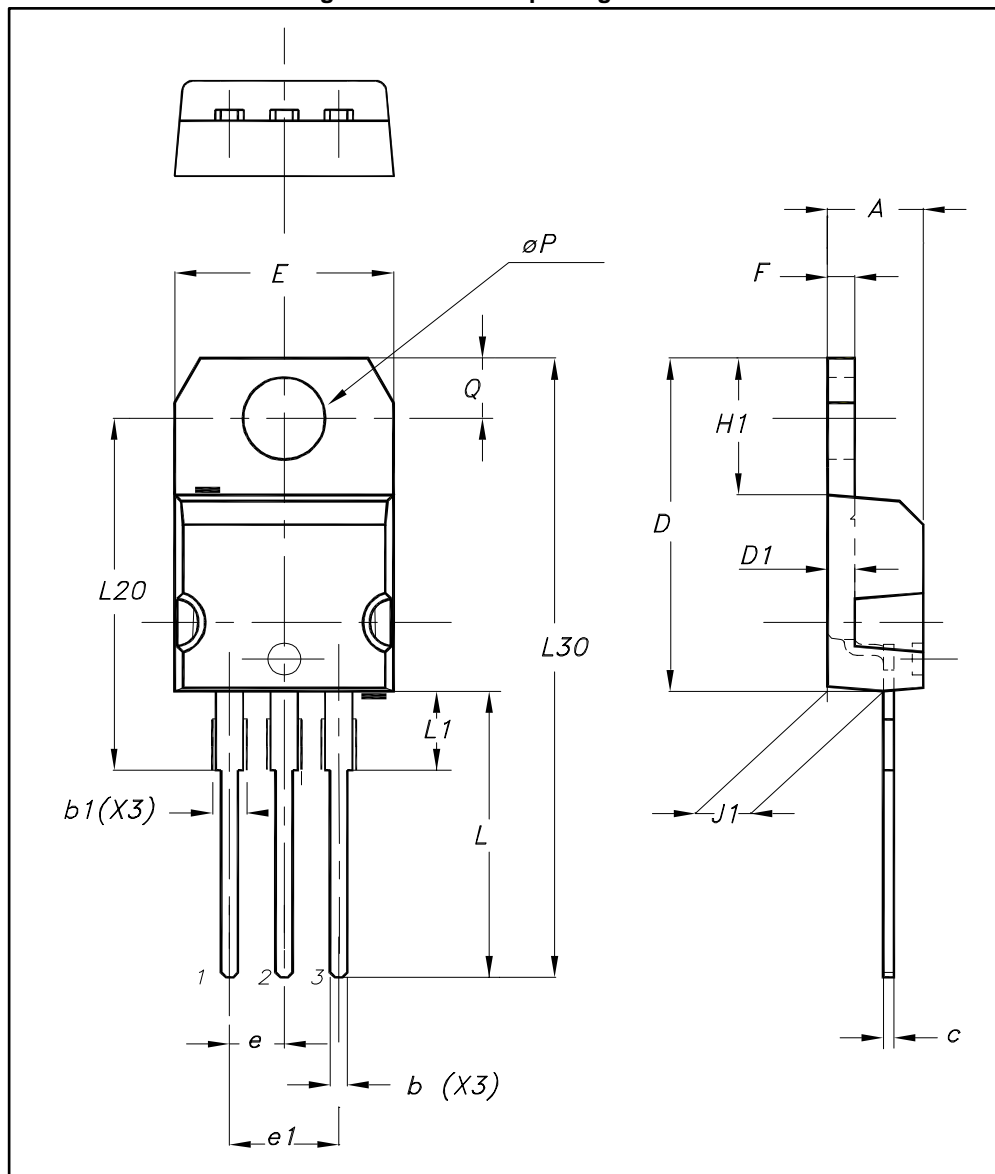

Table 5: TO-220AB package mechanical data

Ref.	Dimensions			
	Millimeters		Inches	
	Min.	Max.	Min.	Max.
A	4.40	4.60	0.173	0.181
b	0.61	0.88	0.240	0.035
b1	1.14	1.70	0.045	0.067
c	0.48	0.70	0.019	0.028
D	15.25	15.75	0.600	0.620
D1	1.27 typ.		0.050 typ.	
E	10.00	10.40	0.394	0.409
e	2.40	2.70	0.094	0.106
e1	4.95	5.15	0.195	0.203
F	1.23	1.32	0.048	0.052
H1	6.20	6.60	0.244	0.260
J1	2.40	2.72	0.094	0.107
L	13.00	14.00	0.512	0.551
L1	3.50	3.93	0.138	0.155
L20	16.40 typ.		0.646 typ.	
L30	28.90 typ.		1.138 typ.	
θP	3.75	3.85	0.148	0.152
Q	2.65	2.95	0.104	0.116

3 Ordering information

Table 6: Ordering information

Order code	Marking	Package	Weight	Base qty.	Delivery mode
STPS60170CT	STPS60170CT	TO-220AB	1.95 g	50	Tube

4 Revision history

Table 7: Document revision history

Date	Revision	Changes
18-Feb-2005	1	First issue.
11-Dec-2015	2	Updated conduction losses equation values and reformatted to current standard.
15-Jan-2018	3	Updated Table 2: "Absolute ratings (limiting values, per diode, at 25 °C, unless otherwise specified)" .

IMPORTANT NOTICE – PLEASE READ CAREFULLY

STMicroelectronics NV and its subsidiaries ("ST") reserve the right to make changes, corrections, enhancements, modifications, and improvements to ST products and/or to this document at any time without notice. Purchasers should obtain the latest relevant information on ST products before placing orders. ST products are sold pursuant to ST's terms and conditions of sale in place at the time of order acknowledgement.

Purchasers are solely responsible for the choice, selection, and use of ST products and ST assumes no liability for application assistance or the design of Purchasers' products.

No license, express or implied, to any intellectual property right is granted by ST herein.

Resale of ST products with provisions different from the information set forth herein shall void any warranty granted by ST for such product.

ST and the ST logo are trademarks of ST. All other product or service names are the property of their respective owners.

Information in this document supersedes and replaces information previously supplied in any prior versions of this document.

© 2018 STMicroelectronics – All rights reserved

Mouser Electronics

Authorized Distributor

Click to View Pricing, Inventory, Delivery & Lifecycle Information:

[STMicroelectronics:](#)

[STPS60170CT](#)