



SPECIFICATION

NO.:CXT280H02H34-200P50R

ACCEPTED BY CUSTOMER	
-------------------------------------	--

Product: 2.8" TFT 240(RGB) *320 Pixels

Verson: V00

Date: 2014/01/02

APPROVED	CHECKED	PREPARED

深圳市朝显联合光电有限公司
地址(Address): 深圳市宝安区西乡街道九围村蔗园埔 4 区 161 栋 4 楼
电话(Tel): +86-13922842237
电子邮箱(E-mail): 262224897@qq.com



Catal og:

NO.	Contents	Page
1	Hi story Verson	1
2	Mechanical Description	2
3	Mechanical Drawing	3
4	Interface Definition	4-5
5	Interface Timing	6-9
6	Absolute Maximum Ratings	10
7	DC Characteristics	10
8	Blacklight	10-11
9	Optical Specification	11-12
10	Touch Panel	13
11	Reliability testing	14
12	Inspection Standard	15-16
13	Precaution	16-17

Chaoxianlianhe



1. History Verson

Sample version	Doc. version	Date	Description	Modify
V00	V00	2014-01-02	First issue	Hai bo_Qin

ChaoXianLianhe



2. Mechanical Description

Name	Content	Unit
Outline Size	50.00 (W) * 69.20 (H) * 3.4(T)	mm
Module size	2.8 (A.A)	inch
Resolution	240(RGB)* 320 Pixels	-
Viewing size	43.20(W) * 57.60(H)	mm
Pixel size	0.180 * 0.180	mm
LCD Type	TFT (262K)/ Transmissive	-
Viewing Angle	12 H	-
Driver IC	ILI9341V	-
Backlight Type	4 Parallel LED	-
Interface Type	RGB / MCU /SPI	-



4. Interface Definition

PIN NO.	PIN Name	Funtion Description
1	ID(GND)	Ground
2	VSS	Ground
3	I0VCC	Power supply for logic.
4	VSS	Ground
5	VCC	Power supply for system.
6	VSYNC	Vertical sync input in RGB mode(short to GND if not used)
7	HSYNC	Horizontal sync input in RGB mode(short to GND if not used)
8	ENABLE	Data enable in RGB mode. (short to GND if not used)
9	DOTCLK	Colock signal in RGB mode. (short to GND if not used)
10	DNC_SCL	Data/command selection pin in MCU interface.
11	RESET	Reset pin for system.
12	SDI	Serial data input in SPI interface.
13	NWR_SCL	Write signal in MCU interface/clock input in SPI interface.
14	NRD	Read signal in MCU interface.
15	NCS	Chip selection signal in MCU interface.
16	TE	Frame mark output pin.
17-34	DO-D17	Data bus.
35	SDO	Serial data output in SPI interface.
36-37	NC	No connection.
38	YU	touch panel Y-up
39	XL	touch panel X-left
40	YD	touch panel Y-bottom
41	XR	touch panel X-right
42	IM3	Interface selection pin, for detail please see note1.
43	IM2	
44	IM1	
45	IM0	
46-49	LEDK4-LEDK1	back light power supply negative
50	LEDA	back light power supply positive

Note 1:



深圳市朝显联合光电有限公司
 Shenzhen CX United Opto Electronic Co., Ltd

IM3	IM2	IM1	IM0	MCU-Interface Mode	DB Pin in use	
					Register/Content	GRAM
0	0	0	0	80 MCU 8-bit bus interface I	D[7:0]	D[7:0]
0	0	0	1	80 MCU 16-bit bus interface I	D[7:0]	D[15:0]
0	0	1	0	80 MCU 9-bit bus interface I	D[7:0]	D[8:0]
0	0	1	1	80 MCU 18-bit bus interface I	D[7:0]	D[17:0]
0	1	0	1	3-wire 9-bit data serial interface I	SDA: In/OUT	
0	1	1	0	4-wire 8-bit data serial interface I	SDA: In/OUT	
1	0	0	0	80 MCU 16-bit bus interface II	D[8:1]	D[17:10], D[8:1]
1	0	0	1	80 MCU 8-bit bus interface II	D[17:10]	D[17:10]
1	0	1	0	80 MCU 18-bit bus interface II	D[8:1]	D[17:0]
1	0	1	1	80 MCU 9-bit bus interface II	D[17:10]	D[17:9]
1	1	0	1	3-wire 9-bit data serial interface II	SDI: In SDO: Out	
1	1	1	0	4-wire 8-bit data serial interface II	SDI: In SDO: Out	

ChaoXI



5. Interface Timing:

5.1 Reset Timing

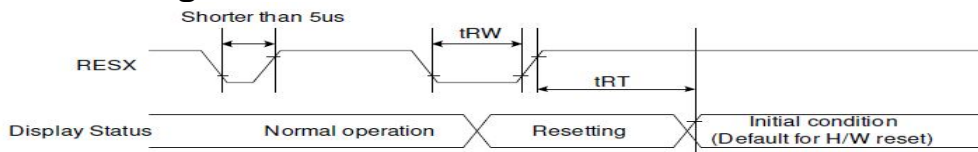

Signal	Symbol	Parameter	Min	Max	Unit
RESX	tRW	Reset pulse duration	10	5 (note 1,5)	uS
	tRT	Reset cancel		120 (note 1,6,7)	mS

5.2 RGB Interface Timing

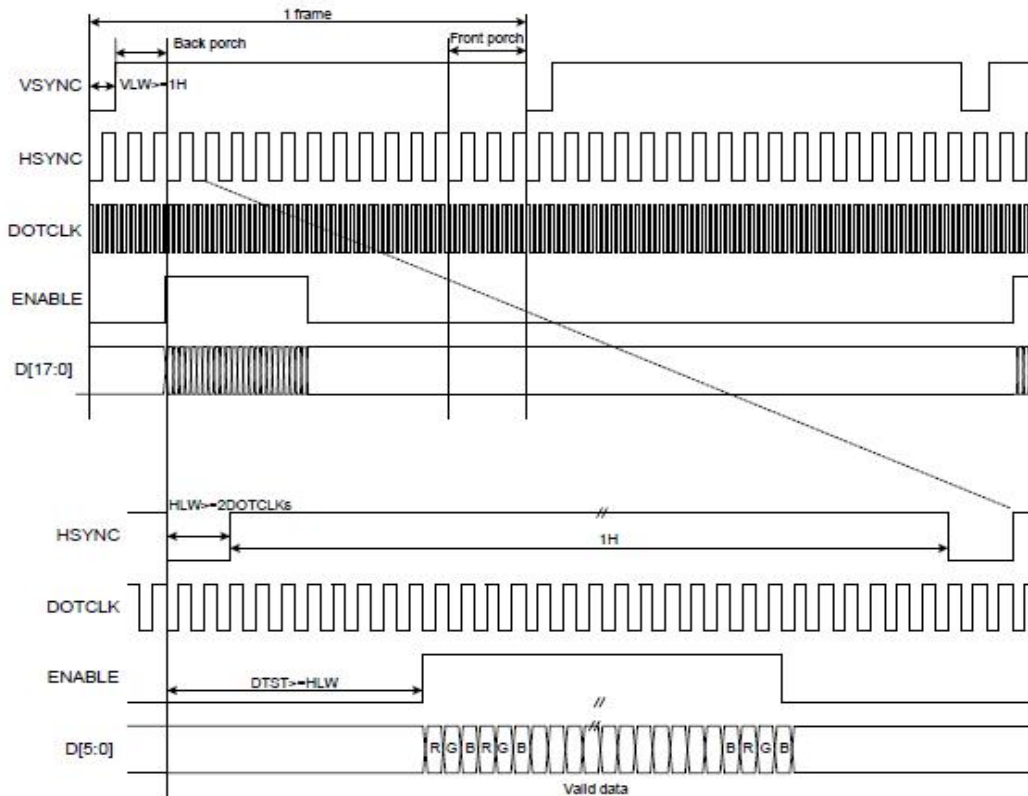

VLW : VSYNC Low Width
HLW : HSYNC Low Width
DTST : Data Transfer Startup Time

Parameters	Symbols	Condition	Min.	Typ.	Max.	Units
Horizontal Synchronization	Hsync		2	10	16	DOTCLK
Horizontal Back Porch	HBP		2	20	24	DOTCLK
Horizontal Address	HAdr		-	240	-	DOTCLK
Horizontal Front Porch	HFP		2	10	16	DOTCLK
Vertical Synchronization	Vsync		1	2	4	Line
Vertical Back Porch	VBP		1	2	-	Line
Vertical Address	VAdr		-	320	-	Line
Vertical Front Porch	VFP		3	4	-	Line

5.3 MCU Interface Timing



深圳市朝显联合光电有限公司
Shenzhen CX United Opto Electronic Co., Ltd

Signal	Symbol	Parameter	min	max	Unit	Description
DCX	tast	Address setup time	0	-	ns	
	taht	Address hold time (Write/Read)	0	-	ns	
CSX	tchw	CSX "H" pulse width	0	-	ns	
	tcs	Chip Select setup time (Write)	15	-	ns	
	trcs	Chip Select setup time (Read ID)	45	-	ns	
	trcsfm	Chip Select setup time (Read FM)	355	-	ns	
	tcsf	Chip Select Wait time (Write/Read)	10	-	ns	
WRX	twc	Write cycle	66	-	ns	
	twrh	Write Control pulse H duration	15	-	ns	
	twrl	Write Control pulse L duration	15	-	ns	
RDX (FM)	trcfm	Read Cycle (FM)	450	-	ns	
	trdhfm	Read Control H duration (FM)	90	-	ns	
	trdlfm	Read Control L duration (FM)	355	-	ns	
RDX (ID)	trc	Read cycle (ID)	160	-	ns	
	trdh	Read Control pulse H duration	90	-	ns	
	trdl	Read Control pulse L duration	45	-	ns	
D[17:0], D[17:10]&D[8:1], D[17:10], D[17:9]	tdst	Write data setup time	10	-	ns	For maximum CL=30pF For minimum CL=8pF
	tdht	Write data hold time	10	-	ns	
	trat	Read access time	-	40	ns	
	tratfm	Read access time	-	340	ns	
	trod	Read output disable time	20	80	ns	

Note: $T_a = -30$ to 70 °C, $V_{DDI}=1.65V$ to $3.3V$, $V_{CI}=2.5V$ to $3.3V$, $V_{SS}=0V$.

2) SPI AC Timing

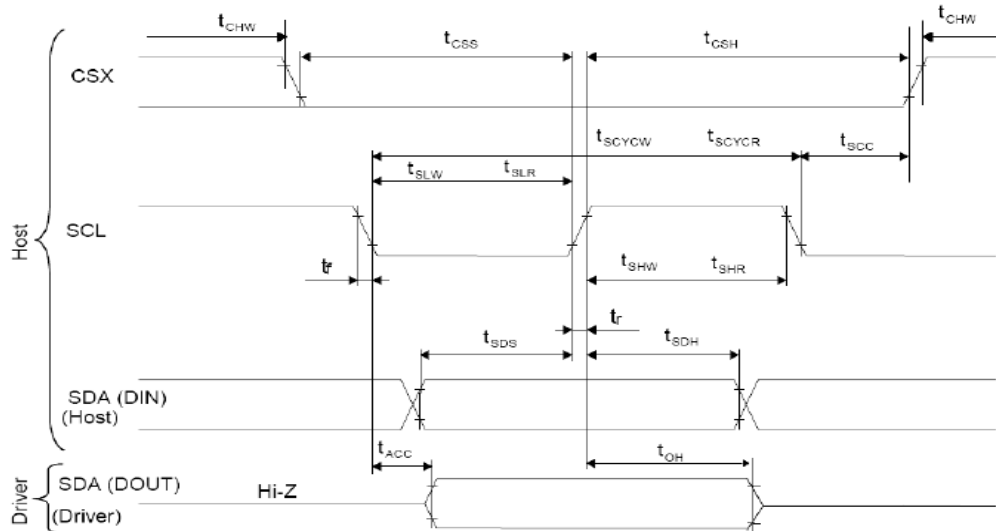

Signal	Symbol	Parameter	min	max	Unit	Description
SCL	tscycw	Serial Clock Cycle (Write)	100	-	ns	
	tshw	SCL "H" Pulse Width (Write)	40	-	ns	
	tslw	SCL "L" Pulse Width (Write)	40	-	ns	
	tscycr	Serial Clock Cycle (Read)	150	-	ns	
	tshr	SCL "H" Pulse Width (Read)	60	-	ns	
	tslr	SCL "L" Pulse Width (Read)	60	-	ns	
SDA / SDI (Input)	tsds	Data setup time (Write)	30	-	ns	
	tsdh	Data hold time (Write)	30	-	ns	
SDA / SDO (Output)	tacc	Access time (Read)	10	-	ns	
	tOH	Output disable time (Read)	10	50	ns	
CSX	tsc	SCL-CSX	20	-	ns	
	tchw	CSX "H" Pulse Width	40	-	ns	
	tcss	CSX-SCL Time	60	-	ns	
	tcs		65	-	ns	

Note: $T_a = 25$ °C, $V_{DDI}=1.65V$ to $3.3V$, $V_{CI}=2.5V$ to $3.3V$, $AGND=V_{SS}=0V$

3) RGB AC Timing



深圳市朝显联合光电有限公司
Shenzhen CX United Opto Electronic Co., Ltd

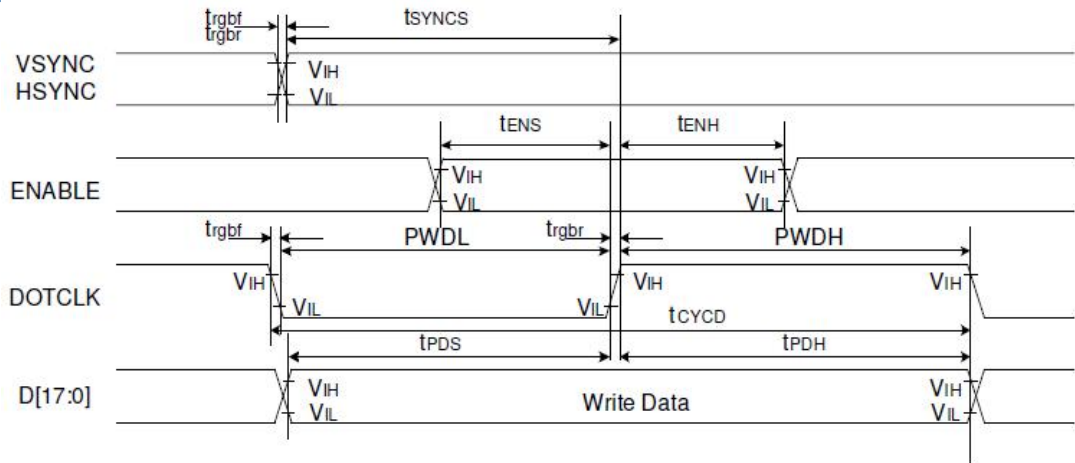

Signal	Symbol	Parameter	min	max	Unit	Description
VSYNC / HSYNC	t_{SYNCS}	VSYNC/HSYNC setup time	15	-	ns	18/16-bit bus RGB interface mode
	t_{SYNCH}	VSYNC/HSYNC hold time	15	-	ns	
DE	t_{ENS}	DE setup time	15	-	ns	
	t_{ENH}	DE hold time	15	-	ns	
D[17:0]	t_{POS}	Data setup time	15	-	ns	
	t_{PDH}	Data hold time	15	-	ns	
DOTCLK	$PWDH$	DOTCLK high-level period	15	-	ns	
	$PWDL$	DOTCLK low-level period	15	-	ns	
	t_{CYCD}	DOTCLK cycle time	100	-	ns	
	t_{rgbr}, t_{rgbf}	DOTCLK,HSYNC,VSYNC rise/fall time	-	15	ns	
VSYNC / HSYNC	t_{SYNCS}	VSYNC/HSYNC setup time	15	-	ns	6-bit bus RGB interface mode
	t_{SYNCH}	VSYNC/HSYNC hold time	15	-	ns	
DE	t_{ENS}	DE setup time	15	-	ns	
	t_{ENH}	DE hold time	15	-	ns	
D[17:0]	t_{POS}	Data setup time	15	-	ns	
	t_{PDH}	Data hold time	15	-	ns	
DOTCLK	$PWDH$	DOTCLK high-level pulse period	15	-	ns	
	$PWDL$	DOTCLK low-level pulse period	15	-	ns	
	t_{CYCD}	DOTCLK cycle time	100	-	ns	
	t_{rgbr}, t_{rgbf}	DOTCLK,HSYNC,VSYNC rise/fall time	-	15	ns	

Note: $T_a = -30$ to 70 °C, $V_{DDI}=1.65V$ to $3.3V$, $V_{CI}=2.5V$ to $3.3V$, $AGND=VSS=0V$

Chao



6. Absolute Maximum Ratings:

Name	symbol	Min	Type	Max	Unit
Operation Temperature	T _{OP}	-10	-	60	°C
Storage Temperature	T _{ST}	-20	-	70	°C

7. DC Characteristics

Name	Symbol	Min	Type	Max	Unit
System Voltage	VCC	2.6	2.8	3.0	V
Logic Voltage	I _{OVCC}	1.8	-	3.3	
Input High Voltage	V _{IH}	0.8I _{OVCC}	-	I _{OVCC}	V
Input Low Voltage	V _{IL}	-0.3	-	0.2I _{OVCC}	V
Output High Voltage	V _{OH}	0.8I _{OVCC}	-	-	V
Output Low Voltage	V _{OL}	-	-	0.2I _{OVCC}	V
Current Consumption	I _{CC}	-	-	25	mA

8. Backlight:

Name	Min	Type	Max	Unit
Current	-	60	70	mA
Voltage	-	3.2	3.4	V
Power Consumption	-	192	-	mW
Lumiance	150	200	-	CD/M ² (Note1)
Lumiance uniformity	75%	80%	-	(Note2)
X Color Coordinates	0.27	0.28	0.31	-
Y Color Coordinates	0.27	0.28	0.31	-

Note1: This lumiance is tested with assembling the LCD.



Note2: Definition of Luminance Uniformity.

Active area is divided into 9 measuring areas (Refer to Fig. 4-4).Every measuring point is placed at the center of each measuring area.

$$\text{Luminance Uniformity (Yu)} = \frac{B_{\min}}{B_{\max}}$$

L-----Active area length W----- Active area width

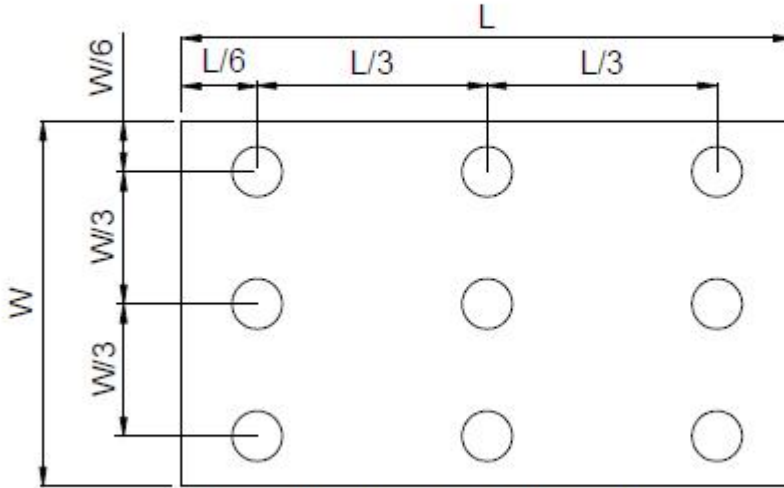

Fig. 4-4 Definition of measuring points

B_{\max} : The measured maximum luminance of all measurement position.

B_{\min} : The measured minimum luminance of all measurement position.

9. Optical Specification

Name	Symbol	Min	Type	Max	Unit
Transmittance rate	T(%)	-	4.6	-	%
Contrast ratio	C/R	400	500	-	-
Response time	Tr+Tf	-	45	-	ms
Viewing Angle	θU	40	50	-	degree (C/R>10)
	θD	35	45	-	
	θL	35	45	-	
	θR	10	20	-	

*Viewing angle description:



深圳市朝显联合光电有限公司
Shenzhen CX United Opto Electronic Co., Ltd

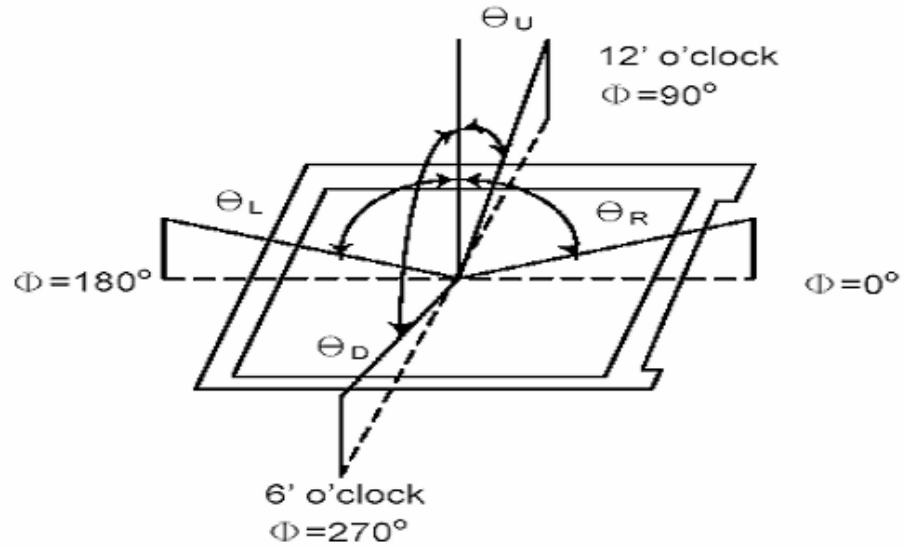

*Contrast rate description(CR) :
 Tested in the center of the LCM panel

$$CR = \frac{\text{Luminance with all pixels white}}{\text{Luminance with all pixels black}}$$

*Response time description : Sum of TR and TF

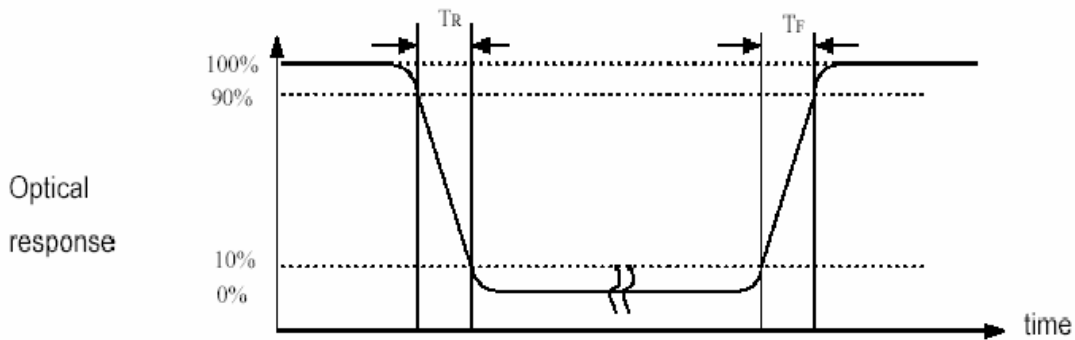
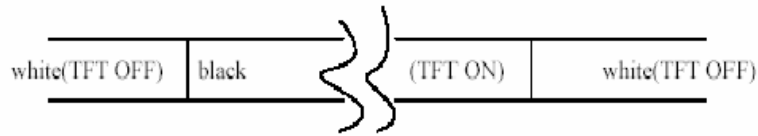



10.Touch Panel:

Item	Description	Unit
linearity	<1.5%	-
transmittance	>80%	-
Response time	<10	ms
Life time	1,000,000	times
Operation pressure	60~100	g
Circuit level	3~15	V

Chaoxianlianhe



11. Reliability testing:

Item No	Name	Condition	Remark
1	High temperature Operating	70° C , 168Hours	Finish product (With polarizer)
2	Low temperature Operating	-20° C , 168 Hours	Finish product (With polarizer)
3	High temperature Storage	80° C , 168 Hours	Finish product (With polarizer)
4	Low temperature Storage	-30° C , 168 Hours	Finish product (With polarizer)
5	High temperature & humidity Storage	60° C , 90%RH, 168 Hours	Finish product (With polarizer)
6	Thermal Shock Storage(No operation)	-20° C , 30min. <=> 70° C , 30min. 10 Cycles	Finish product (With polarizer)
7	ESD test	Vol tage: +8KV R: 330 ohm, C: 150pF Air discharge, 10 times	Finish product (With polarizer)
8	Vibration test	10 => 55 =>10 => 55 => 10 Hz, with in 1 minute; Ampli tude: 1.5mm. 15 minutes for each Direction (X, Y, Z)	Finish product (With polarizer)
9	Drop test	Packed, 100CM free fall 6 sides, 1 corner, 3edges	Finish product (With polarizer)

*One single product test for only one item.

* Judgment after test: keep in room temperature for more than 2 hours.

- Current consumption < 2 times of initial value
- Contrast > 1/2 initial value
- Function: work normally



12. Inspection Standard

12.1 Defect Definition

No.	Defect Class	Defination	Content
1	重缺陷 (MA)	影响显示的功能缺陷	短路、断路、缺划、大电流、视角错、漏液、显示不清等
		严重外观缺陷	产品尺寸不符、漏部品等
2	轻缺陷 (MI)	不影响产品功能, 但对产品外观有影响	反黑 / 反白点、偏光片缺陷、针孔、污点

12.2 Standard

No.	Item	Inspection Standard	Classification of defects
-----	------	---------------------	---------------------------

1	显示状态	不显、显示乱码、多划、少划、少画面、视角错、闪烁等均不允许	重缺陷
		无法用文字描述的现象, 必要时制定限度样板进行参考。如: 显示不均、显示浓淡、斜纹等	
		显示的颜色效果参照开发、工程样品或按限度样板判定	
		画面切换过程中可见(但非画异)之不良现象(暂停画面时不良现象不可见)不作管控, 客户有特殊要求时依客户要求;	轻缺陷
		仅点背光不显示画面下可见不良现象(但显示画面时不良现象不可见)不作管控, 客户有特殊要求时依客户要求;	轻缺陷
2	背光	LED 灯不亮或闪烁不稳定不允许	重缺陷
		背光电流: 超出规格范围不允许	
		亮眼、漏光: 进入 LCD 的 A、B 区不允许, 必要时按限度样板做判定	轻缺陷
		背光颜色: 根据样品、规格书判定	轻缺陷
		亮度与发光均匀度参照开发、工程或限度样板判定	轻缺陷

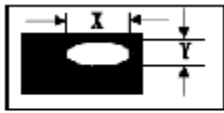
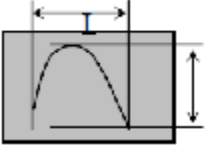
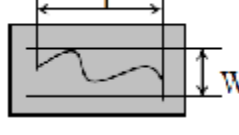

No.	Item	Inspection Standard			Classification of defects
3	显示黑点 白点 针孔	直径 ($\Phi = (X+Y) / 2$)	允收数	图示	轻缺陷
		$\Phi \leq 0.1$ (密集不可)	不计		
		$0.1 < \Phi \leq 0.15$ [注2]	2		
		$0.15 < \Phi \leq 0.2$	1		
		$\Phi > 0.2$	0		
		注1. 包括: 黑点、白点、针孔、异物。 注2. 整个产品不允许超过2个点, 且间距必须在10mm以上。			
4	显示黑线 白线	尺寸 (L: 线长; W: 线宽)	允收数	图示	轻缺陷
		L 不计 W < 0.03 (密集不可)	不计		
		$L \leq 2$ $0.03 \leq W \leq 0.05$ [注 2]	2		
		L 不计 W > 0.05	以点判断		
		注1. 包括: 显示黑线、白线、线状异物。 注2. 单个产品不允许超过2个线状缺陷, 且缺陷距离必须大于10mm以上。			
5	触摸屏	点击触摸屏测试点画面无转换不允许			重缺陷

13. Precaution

13.1 Handling

- (1) Protect the panel from static, it may cause damage to the CMOS Gate Array IC.
- (2) Use fingerstalls with soft gloves in order to keep display clean during the incoming inspection and assembly process.
- (3) If the liquid crystal material leaks from the panel, it should be kept away from the eyes or mouth. In case of contact with hands, legs or clothes, it must be washed away thoroughly with soap.
- (4) The desirable cleaners are water, IPA (Isopropyl Alcohol) or Hexane. Don't use Ketone type materials (ex. Acetone), Ethyl alcohol, Toluene, Ethyl acid or Methyl chloride. It might permanent damage to the polarizer due to chemical reaction.
- (5) Pins of I/F connector shall not be touched directly with bare hands.



深圳市朝显联合光电有限公司

Shenzhen CX United Opto Electronic Co., Ltd

(6) Refrain from strong mechanical shock and / or any force to the panel. In addition to damage, this may cause improper operation or damage to the panel.

(7) Note that polarizers are very fragile and could be easily damaged. Do not press or scratch the surface harder than a B pencil lead.

(8) Wipe off water droplets or oil immediately. If you leave the droplets for a long time, staining and discoloration may occur.

(9) If the surface of the polarizer is dirty, clean it using some absorbent cotton or soft cloth.

13.2 Storage

(1) Do not leave the panel in high temperature, and high humidity for a long time. It is highly recommended to store the panel with temperature from 0 to 35°C and relative humidity of less than 70%.

(2) The panel shall be stored in a dark place. It is prohibited to apply sunlight or fluorescent light during the store.

13.3 Operation

(1) The LCD shall be operated within the limits specified. Operation at values outside of these limits may shorten life, and/or harm display images.

(2) Do not exceed the absolute maximum rating value. (the supply voltage variation, Input voltage variation in part contents and environmental temperature and so on). Otherwise the panel may be damaged.

(3) If the panel displays the same pattern continuously for a long period of time, it can be the situation when the image "Sticks" to the screen.