

DATASHEET

UF3C065080T3S

650V-80mΩ SiC FET

Rev. B, December 2019

Description

This SiC FET device is based on a unique ‘cascode’ circuit configuration, in which a normally-on SiC JFET is co-packaged with a Si MOSFET to produce a normally-off SiC FET device. The device’s standard gate-drive characteristics allows for a true “drop-in replacement” to Si IGBTs, Si FETs, SiC MOSFETs or Si superjunction devices. Available in the TO-220-3L package, this device exhibits ultra-low gate charge and exceptional reverse recovery characteristics, making it ideal for switching inductive loads when used with recommended RC-snubbers, and any application requiring standard gate drive.

Features

- ◆ Typical on-resistance $R_{DS(on),typ}$ of 80mΩ
- ◆ Maximum operating temperature of 175°C
- ◆ Excellent reverse recovery
- ◆ Low gate charge
- ◆ Low intrinsic capacitance
- ◆ ESD protected, HBM class 2
- ◆ Very low switching losses (required RC-snubber loss negligible under typical operating conditions)

Typical applications

- ◆ EV charging
- ◆ PV inverters
- ◆ Switch mode power supplies
- ◆ Power factor correction modules
- ◆ Motor drives
- ◆ Induction heating

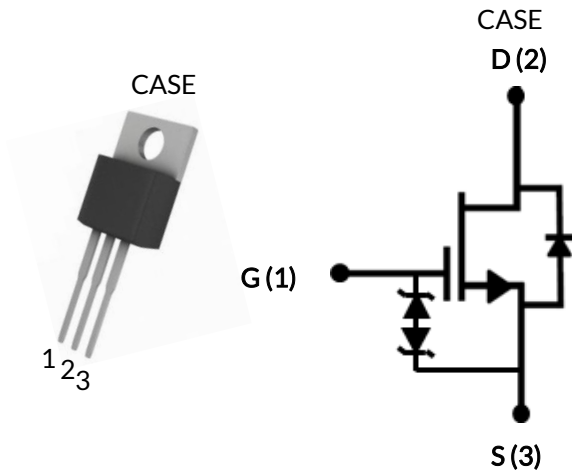

Part Number	Package	Marking
UF3C065080T3S	TO-220-3L	UF3C065080T3S



Maximum Ratings

Parameter	Symbol	Test Conditions	Value	Units
Drain-source voltage	V_{DS}		650	V
Gate-source voltage	V_{GS}	DC	-25 to +25	V
Continuous drain current ¹	I_D	$T_C = 25^\circ\text{C}$	31	A
		$T_C = 100^\circ\text{C}$	23	A
Pulsed drain current ²	I_{DM}	$T_C = 25^\circ\text{C}$	65	A
Single pulsed avalanche energy ³	E_{AS}	$L=15\text{mH}, I_{AS}=2.1\text{A}$	33	mJ
Power dissipation	P_{tot}	$T_C = 25^\circ\text{C}$	190	W
Maximum junction temperature	$T_{J,max}$		175	$^\circ\text{C}$
Operating and storage temperature	T_J, T_{STG}		-55 to 175	$^\circ\text{C}$
Max. lead temperature for soldering, 1/8" from case for 5 seconds	T_L		250	$^\circ\text{C}$

1. Limited by $T_{J,max}$

2. Pulse width t_p limited by $T_{J,max}$

3. Starting $T_J = 25^\circ\text{C}$

Thermal Characteristics

Parameter	Symbol	Test Conditions	Value			Units
			Min	Typ	Max	
Thermal resistance, junction-to-case	$R_{\theta JC}$			0.61	0.79	$^\circ\text{C}/\text{W}$

Electrical Characteristics ($T_J = +25^\circ\text{C}$ unless otherwise specified)

Typical Performance - Static

Parameter	Symbol	Test Conditions	Value			Units
			Min	Typ	Max	
Drain-source breakdown voltage	BV_{DS}	$V_{GS}=0V, I_D=1mA$	650			V
Total drain leakage current	I_{DSS}	$V_{DS}=650V, V_{GS}=0V, T_J=25^\circ\text{C}$		6	100	μA
		$V_{DS}=650V, V_{GS}=0V, T_J=175^\circ\text{C}$		40		
Total gate leakage current	I_{GSS}	$V_{DS}=0V, T_J=25^\circ\text{C}, V_{GS}=-20V / +20V$		6	± 20	μA
Drain-source on-resistance	$R_{DS(on)}$	$V_{GS}=12V, I_D=20A, T_J=25^\circ\text{C}$		80	100	m Ω
		$V_{GS}=12V, I_D=20A, T_J=125^\circ\text{C}$		111		
		$V_{GS}=12V, I_D=20A, T_J=175^\circ\text{C}$		141		
Gate threshold voltage	$V_{G(th)}$	$V_{DS}=5V, I_D=10mA$	4	5	6	V
Gate resistance	R_G	f=1MHz, open drain		4.5		Ω

Typical Performance - Reverse Diode

Parameter	Symbol	Test Conditions	Value			Units
			Min	Typ	Max	
Diode continuous forward current ¹	I_S	$T_C=25^\circ\text{C}$			31	A
Diode pulse current ²	$I_{S,pulse}$	$T_C=25^\circ\text{C}$			65	A
Forward voltage	V_{FSD}	$V_{GS}=0V, I_F=10A, T_J=25^\circ\text{C}$		1.5	2	V
		$V_{GS}=0V, I_F=10A, T_J=175^\circ\text{C}$		1.75		
Reverse recovery charge	Q_{rr}	$V_R=400V, I_F=20A, V_{GS}=-5V, R_{G,EXT}=10\Omega, di/dt=2200A/\mu\text{s}, T_J=25^\circ\text{C}$		119		nC
Reverse recovery time	t_{rr}	$T_J=25^\circ\text{C}$		16		ns
Reverse recovery charge	Q_{rr}	$V_R=400V, I_F=20A, V_{GS}=-5V, R_{G,EXT}=10\Omega, di/dt=2200A/\mu\text{s}, T_J=150^\circ\text{C}$		73		nC
Reverse recovery time	t_{rr}	$T_J=150^\circ\text{C}$		11		ns

Typical Performance - Dynamic

Parameter	Symbol	Test Conditions	Value			Units	
			Min	Typ	Max		
Input capacitance	C_{iss}	$V_{DS}=100V, V_{GS}=0V$ $f=100kHz$		1500		pF	
Output capacitance	C_{oss}			104			
Reverse transfer capacitance	C_{rss}			2.6			
Effective output capacitance, energy related	$C_{oss(er)}$	$V_{DS}=0V$ to 400V, $V_{GS}=0V$		77		pF	
Effective output capacitance, time related	$C_{oss(tr)}$	$V_{DS}=0V$ to 400V, $V_{GS}=0V$		176		pF	
C_{OSS} stored energy	E_{oss}	$V_{DS}=400V, V_{GS}=0V$		6.2		μJ	
Total gate charge	Q_G	$V_{DS}=400V, I_D=20A,$ $V_{GS} = -5V$ to 15V		51		nC	
Gate-drain charge	Q_{GD}			11			
Gate-source charge	Q_{GS}			19			
Turn-on delay time	$t_{d(on)}$	$V_{DS}=400V, I_D=20A,$ Gate Driver = -5V to +15V, Turn-on $R_{G,EXT}=1\Omega,$ Turn-off $R_{G,EXT}=22\Omega$ Inductive Load, FWD: same device with $V_{GS} = -5V$ and $R_G = 22\Omega,$ RC snubber: $R_S=5\Omega$ and $C_S=100pF,$ $T_J=25^\circ C$		25		ns	
Rise time	t_r			14			
Turn-off delay time	$t_{d(off)}$			54			
Fall time	t_f			11			
Turn-on energy including R_S energy ⁴	E_{ON}			182			
Turn-off energy including R_S energy ⁴	E_{OFF}			24			
Total switching energy including R_S energy ⁴	E_{TOTAL}		206		μJ		
Snubber R_S energy during turn-on	E_{RS_ON}		0.6				
Snubber R_S energy during turn-off	E_{RS_OFF}		1.1				
Turn-on delay time	$t_{d(on)}$	$V_{DS}=400V, I_D=20A,$ Gate Driver = -5V to +15V, Turn-on $R_{G,EXT}=1\Omega,$ Turn-off $R_{G,EXT}=22\Omega$ Inductive Load, FWD: same device with $V_{GS} = -5V$ and $R_G = 22\Omega,$ RC snubber: $R_S=5\Omega$ and $C_S=100pF,$ $T_J=150^\circ C$		22		ns	
Rise time	t_r			14			
Turn-off delay time	$t_{d(off)}$			55			
Fall time	t_f			12			
Turn-on energy including R_S energy ⁴	E_{ON}			156			
Turn-off energy including R_S energy ⁴	E_{OFF}			25			
Total switching energy including R_S energy ⁴	E_{TOTAL}			181			μJ
Snubber R_S energy during turn-on	E_{RS_ON}			0.6			
Snubber R_S energy during turn-off	E_{RS_OFF}		1.2				

4. The switching performance are evaluated with a RC snubber circuit as shown in Figure 24.

Typical Performance Diagrams

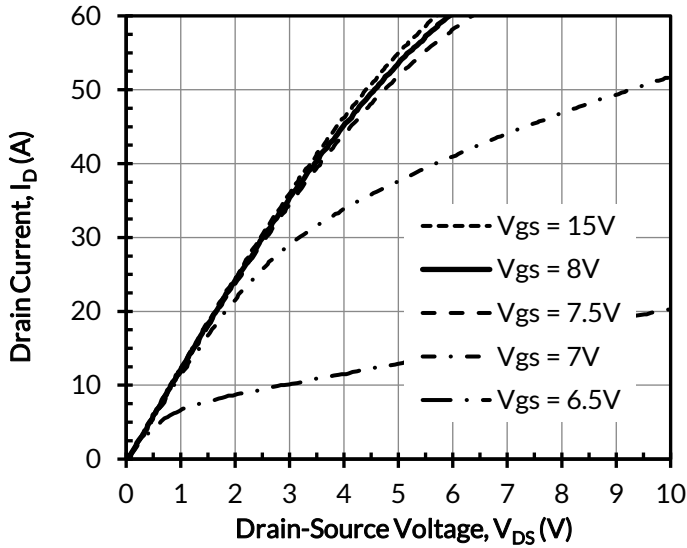

Figure 1. Typical output characteristics at $T_J = -55^\circ\text{C}$, $t_p < 250\mu\text{s}$

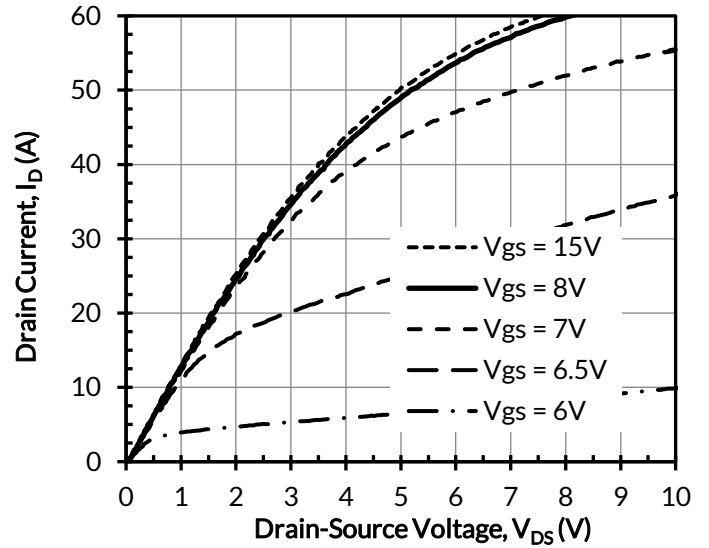

Figure 2. Typical output characteristics at $T_J = 25^\circ\text{C}$, $t_p < 250\mu\text{s}$

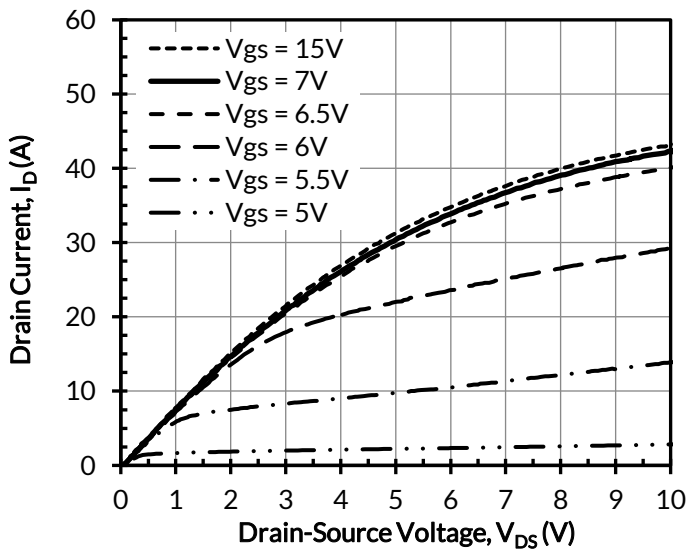

Figure 3. Typical output characteristics at $T_J = 175^\circ\text{C}$, $t_p < 250\mu\text{s}$

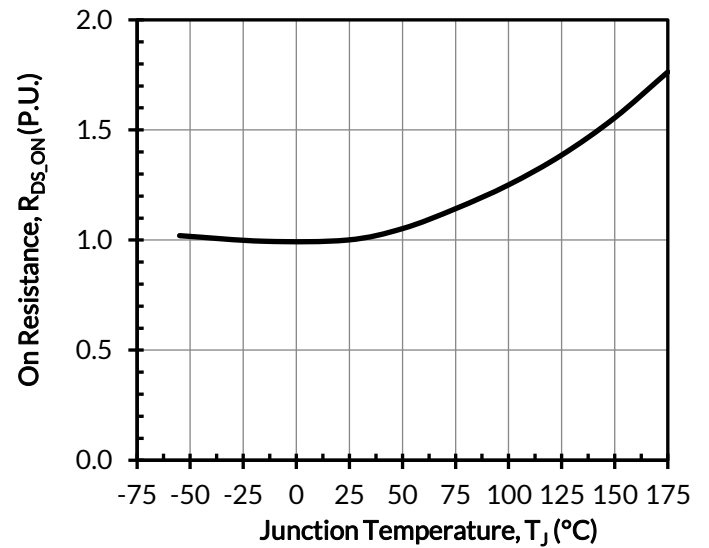

Figure 4. Normalized on-resistance vs. temperature at $V_{GS} = 12\text{V}$ and $I_D = 20\text{A}$

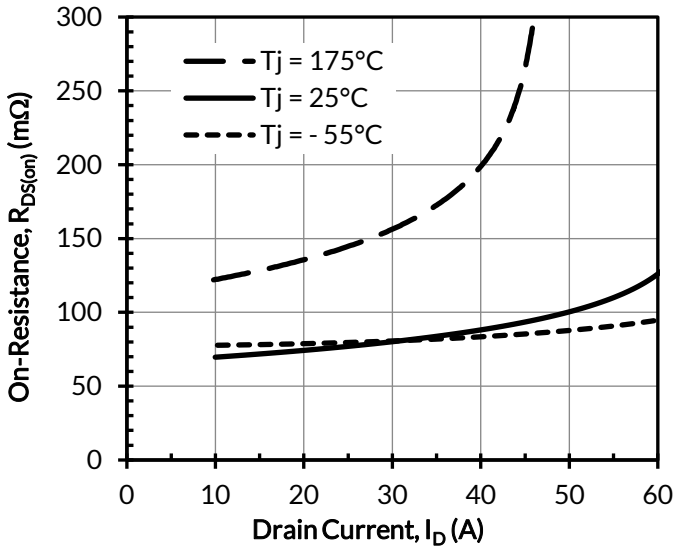

Figure 5. Typical drain-source on-resistances at $V_{GS} = 12V$

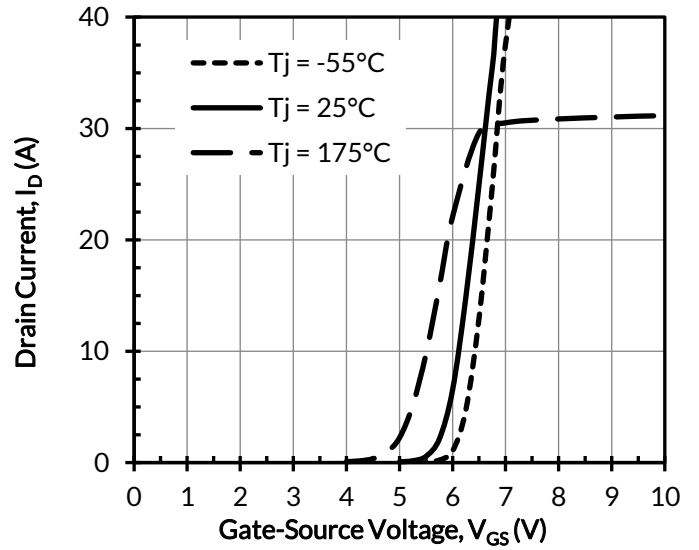

Figure 6. Typical transfer characteristics at $V_{DS} = 5V$

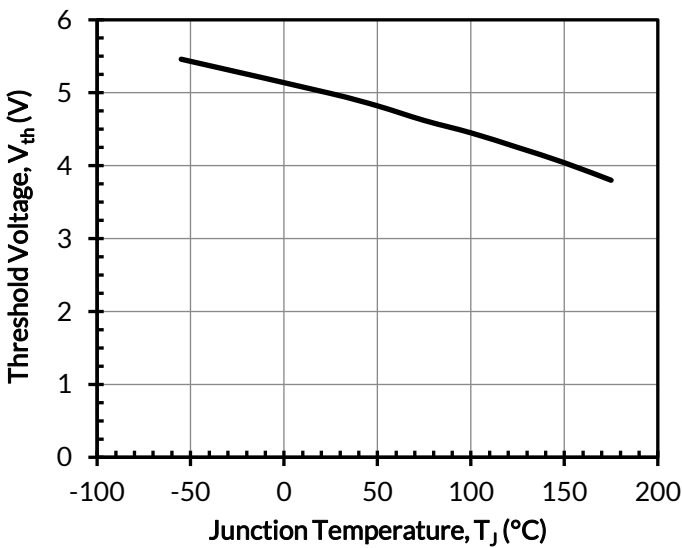

Figure 7. Threshold voltage vs. junction temperature at $V_{DS} = 5V$ and $I_D = 10mA$

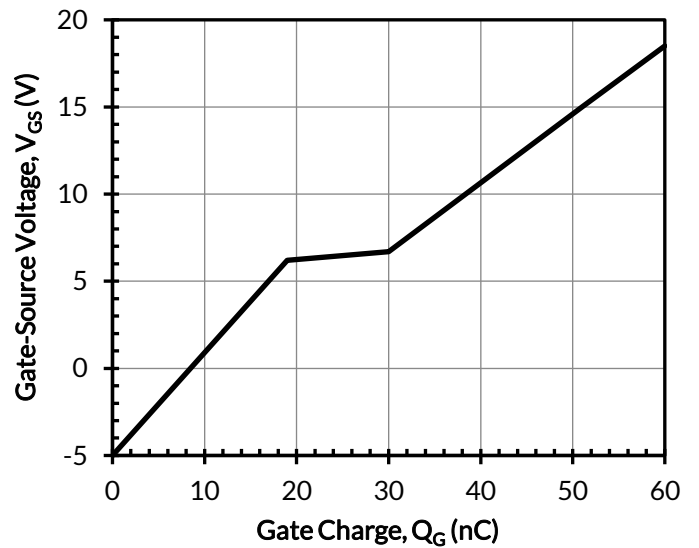

Figure 8. Typical gate charge at $V_{DS} = 400V$ and $I_D = 20A$

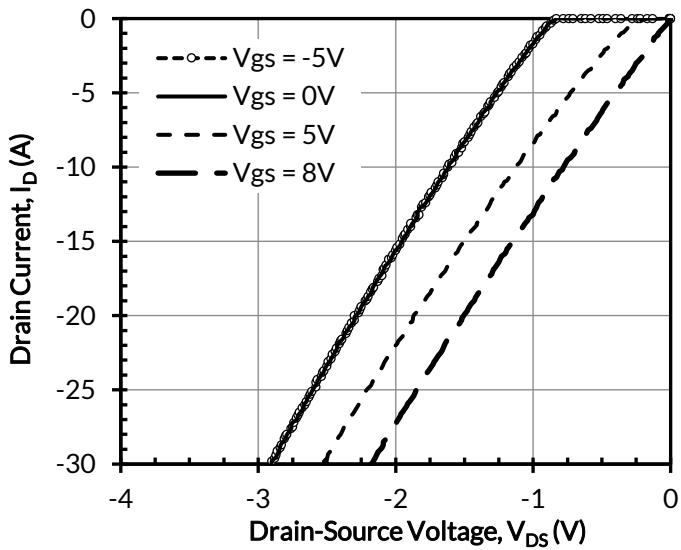

Figure 9. 3rd quadrant characteristics at $T_j = -55^\circ\text{C}$

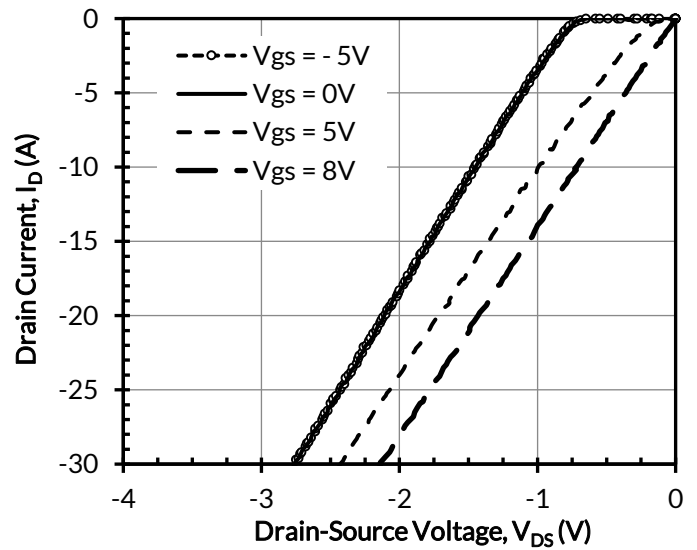

Figure 10. 3rd quadrant characteristics at $T_j = 25^\circ\text{C}$

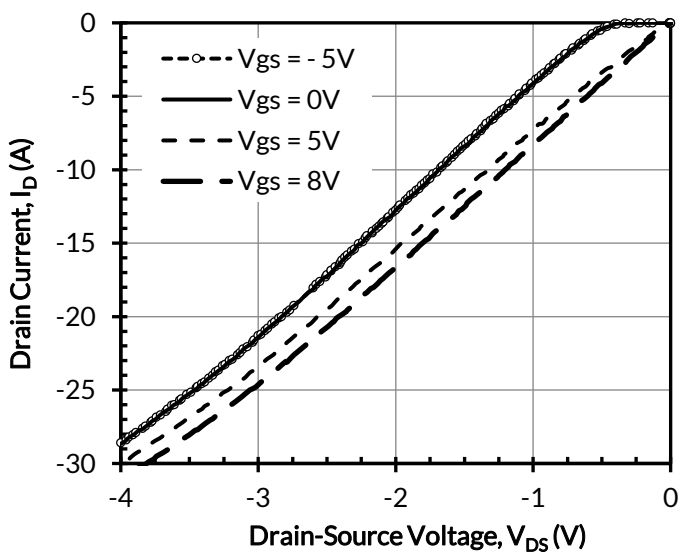

Figure 11. 3rd quadrant characteristics at $T_j = 175^\circ\text{C}$

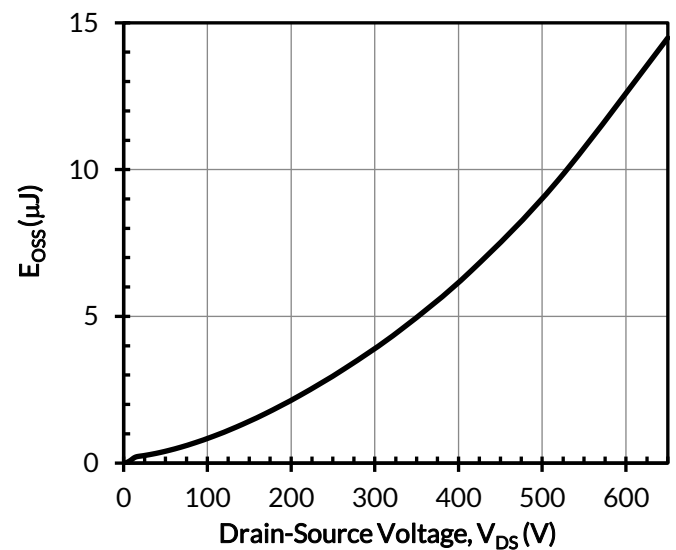

Figure 12. Typical stored energy in C_{OSS} at $V_{GS} = 0\text{V}$

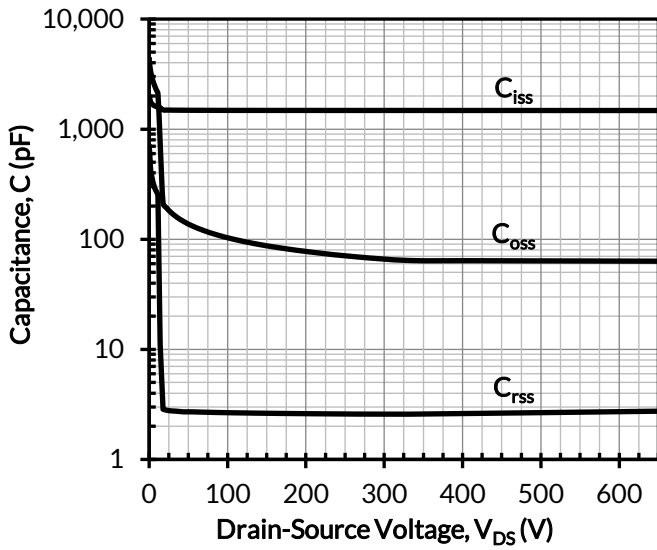

Figure 13. Typical capacitances at $f = 100\text{kHz}$ and $V_{GS} = 0\text{V}$

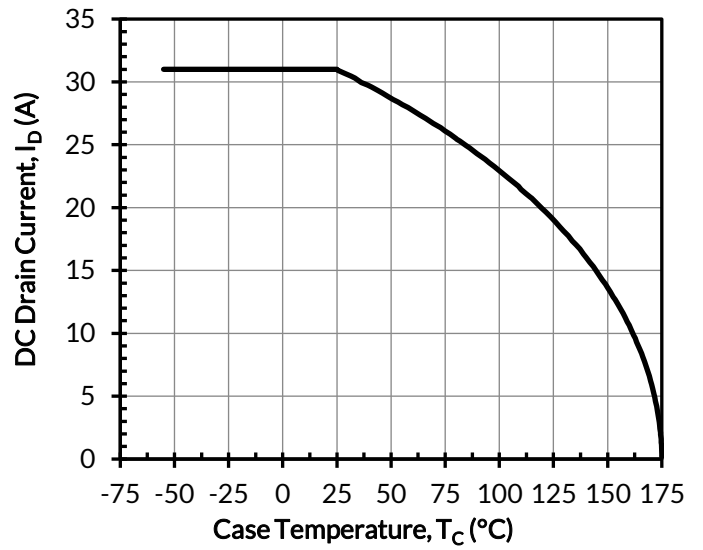

Figure 14. DC drain current derating

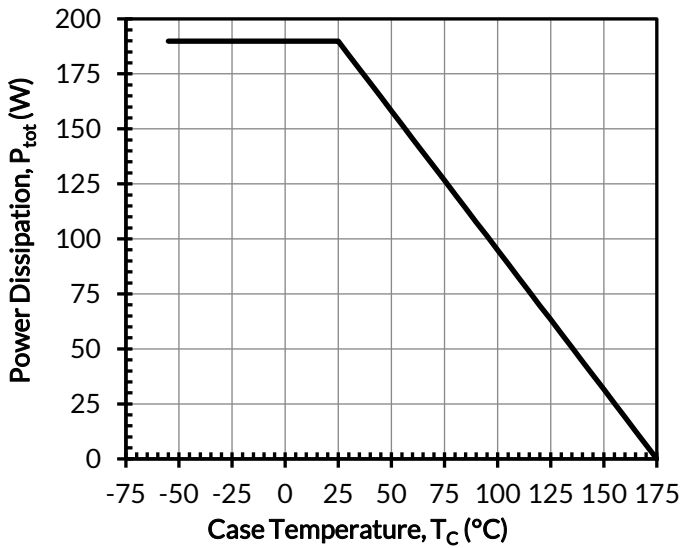

Figure 15. Total power dissipation

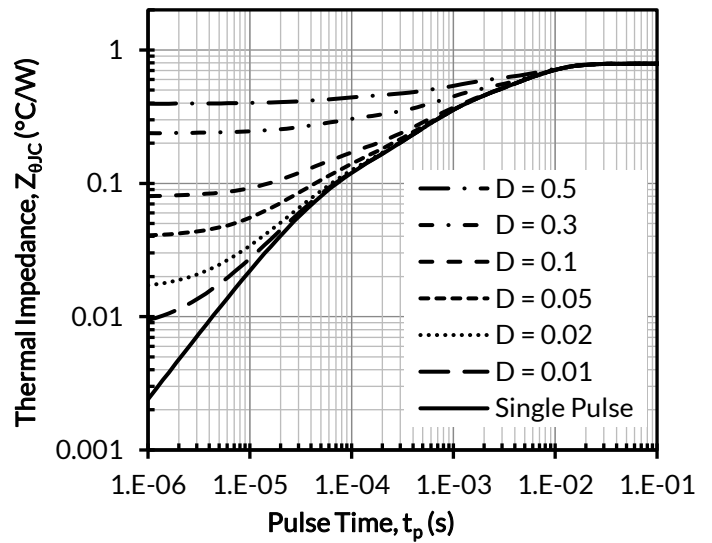

Figure 16. Maximum transient thermal impedance

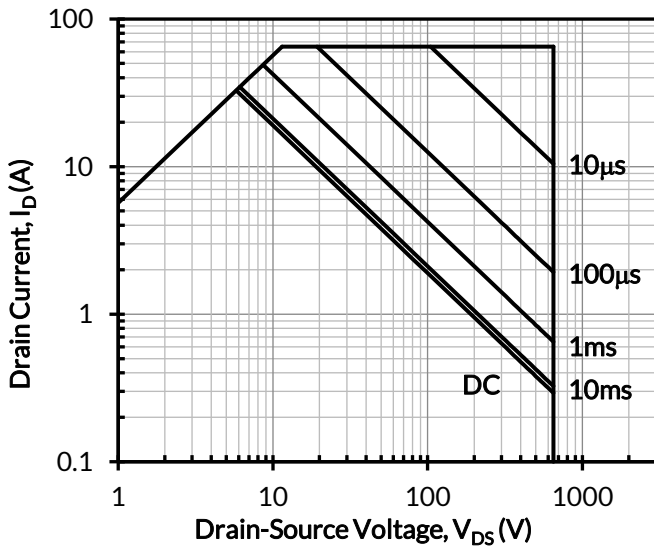

Figure 17. Safe operation area at $T_C = 25^\circ\text{C}$, $D = 0$, Parameter t_p

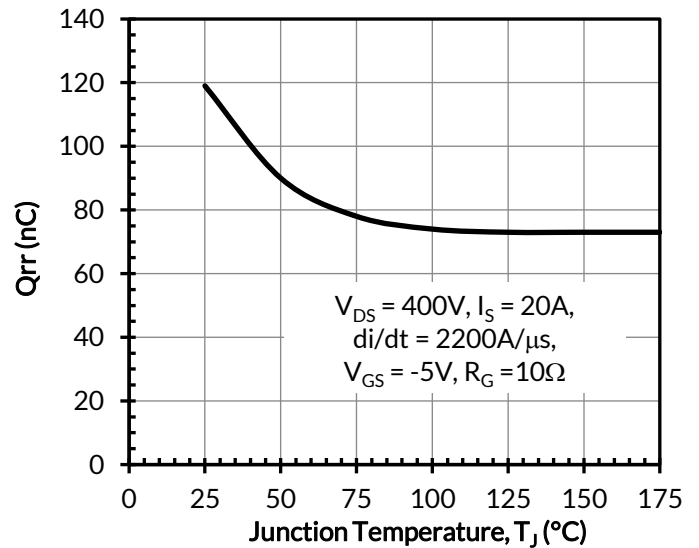
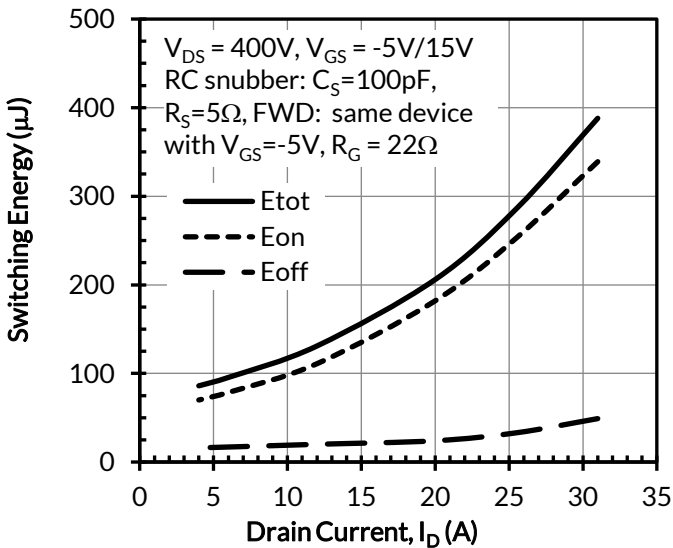
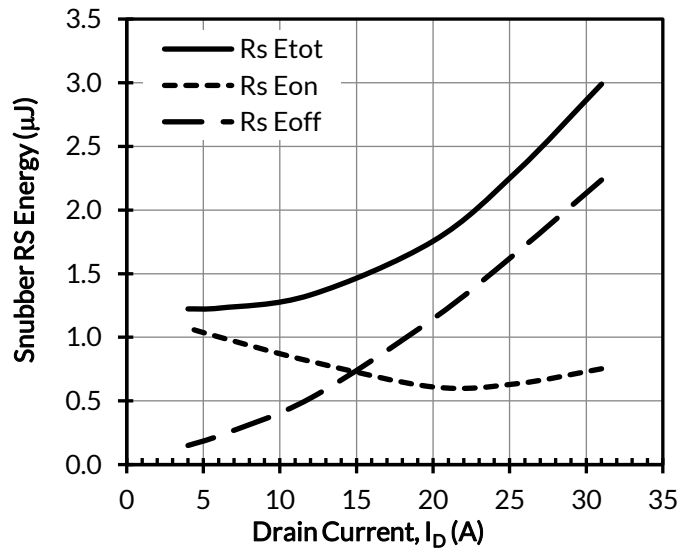

Figure 18. Reverse recovery charge Q_{rr} vs. junction temperature



(a)



(b)

Figure 19. Clamped inductive switching energy (a) and RC snubber energy loss (b) vs. drain current at $T_J = 25^\circ\text{C}$, turn-on $R_{G_EXT} = 1\Omega$, and turn-off $R_{G_EXT} = 22\Omega$

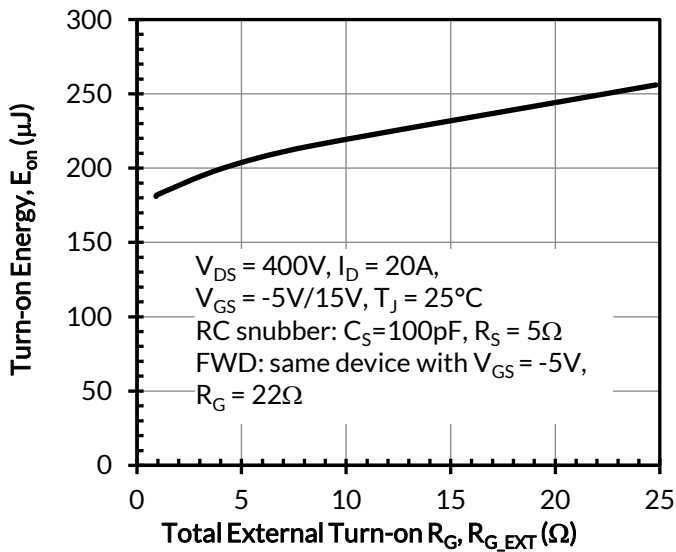

(a)

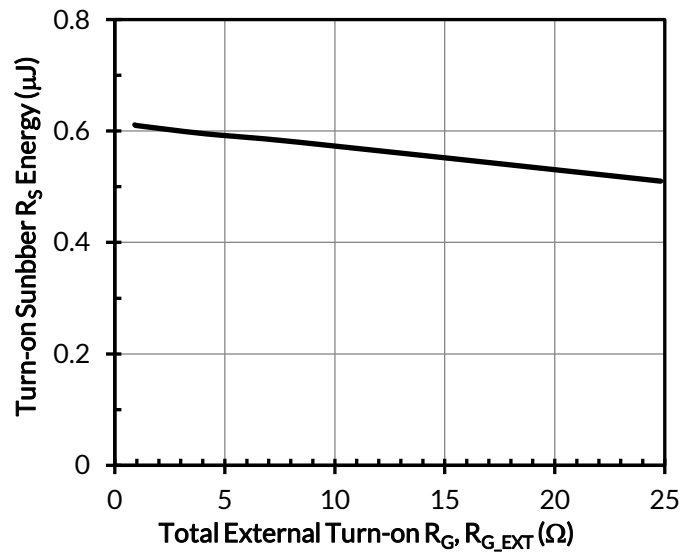

(b)

Figure 20. Clamped inductive switching turn-on energy including RC snubber energy loss (a) and RC snubber energy loss (b) as a function of total external turn-on gate resistor R_{G_EXT}

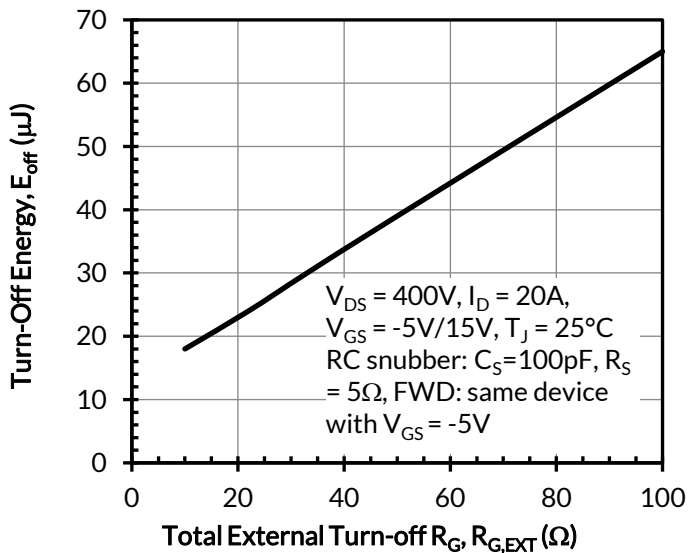

(a)

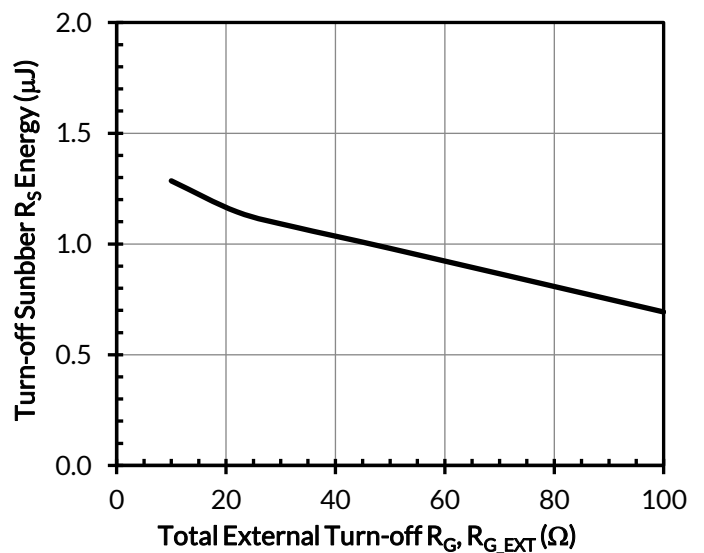

(b)

Figure 21. Clamped inductive switching turn-off energy including RC snubber energy loss (a) and RC snubber energy loss (b) as a function of total external turn-off gate resistor R_{G_EXT}

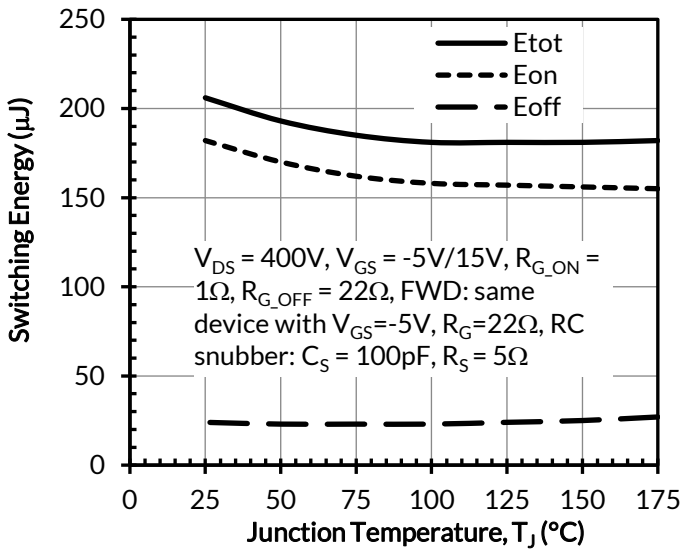

(a)

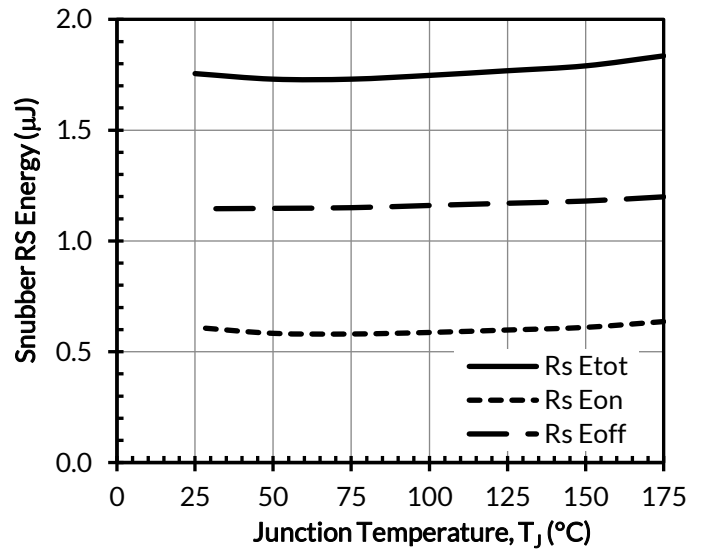

(b)

Figure 22. Clamped inductive switching energy including RC snubber energy loss (a) and RC snubber energy loss (b) as a function of junction temperature at $I_D = 20A$

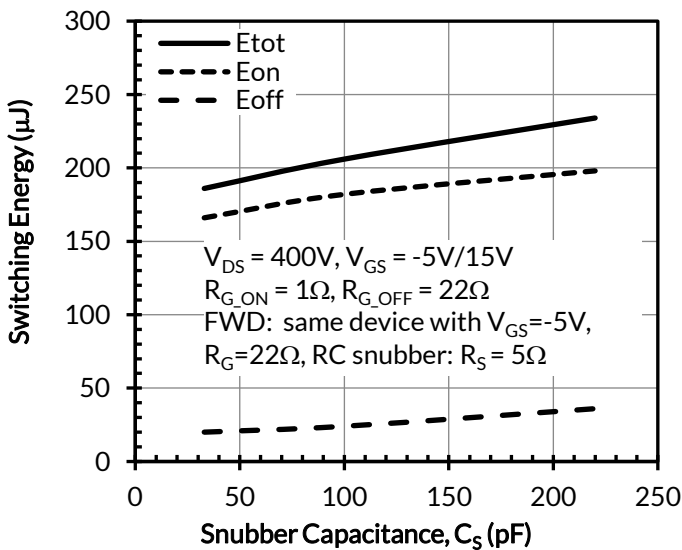

(a)

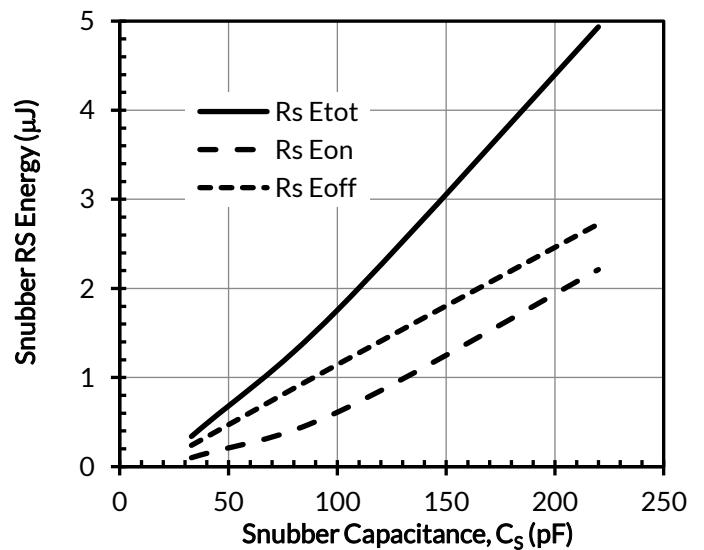

(b)

Figure 23. Clamped inductive switching energy including RC snubber energy loss (a) and RC snubber energy loss (b) as a function of snubber capacitance at $I_D = 20A$ and $T_J = 25^\circ C$

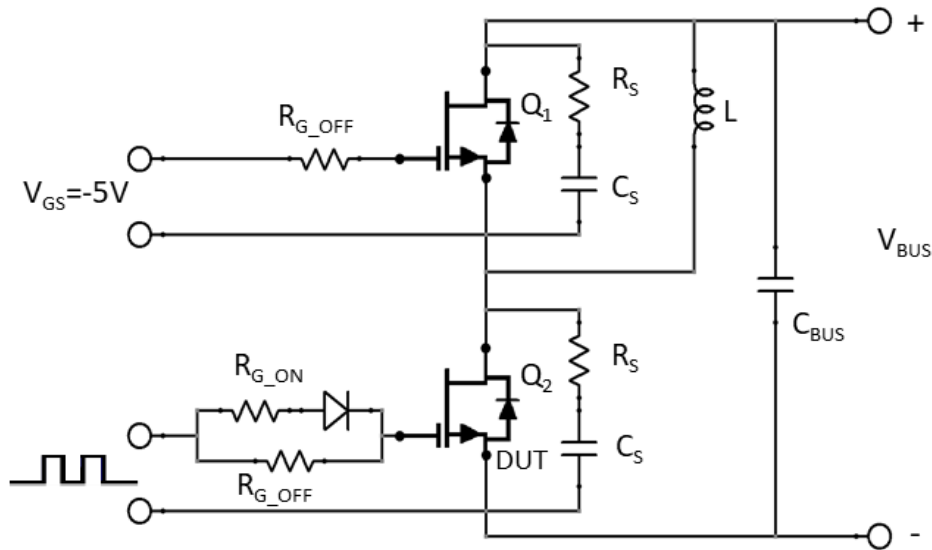

Figure 24. Clamped inductive load switching test circuit
 An RC snubber ($R_S = 5\Omega$ and $C_S = 100\text{pF}$) is required to improve the turn-off waveforms.

Applications Information

SiC FETs are enhancement-mode power switches formed by a high-voltage SiC depletion-mode JFET and a low-voltage silicon MOSFET connected in series. The silicon MOSFET serves as the control unit while the SiC JFET provides high voltage blocking in the off state. This combination of devices in a single package provides compatibility with standard gate drivers and offers superior performance in terms of low on-resistance ($R_{DS(on)}$), output capacitance (C_{oss}), gate charge (Q_G), and reverse recovery charge (Q_{rr}) leading to low conduction and switching losses. The SiC FETs also provide excellent reverse conduction capability eliminating the need for an external anti-parallel diode.

Like other high performance power switches, proper PCB layout design to minimize circuit parasitics is strongly recommended due to the high dv/dt and di/dt rates. An external gate resistor is recommended when the FET is working in the diode mode in order to achieve the optimum reverse recovery performance. For more information on SiC FET operation, see www.unitedsic.com.

Disclaimer

UnitedSiC reserves the right to change or modify any of the products and their inherent physical and technical specifications without prior notice. UnitedSiC assumes no responsibility or liability for any errors or inaccuracies within.

Information on all products and contained herein is intended for description only. No license, express or implied, to any intellectual property rights is granted within this document.

UnitedSiC assumes no liability whatsoever relating to the choice, selection or use of the UnitedSiC products and services described herein.

Mouser Electronics

Authorized Distributor

Click to View Pricing, Inventory, Delivery & Lifecycle Information:

Qorvo:

[UF3C065080T3S](#)