

Measuring and monitoring relays

Product group picture

2



Measuring and monitoring relays

Table of contents

Measuring and monitoring relays

Current and voltage monitoring relays, single-phase.....	2/8
Three-phase monitoring relays	2/26
Grid feeding monitoring relays -	
Voltage and frequency monitoring functions.....	2/48
Insulation monitoring relays for unearthed supply systems	2/52
Motor control and protection.....	2/64
Thermistor motor protection relays	2/70
Temperature monitoring relays.....	2/84
Liquid level monitors and controls.....	2/94
General technical data	2/105
Accessories, Current transformers.....	2/107

Measuring and monitoring relays

Benefits and advantages

CM-N range: Multifunctional



- 45 mm wide housing
- Output contacts: 2 c/o (SPDT) contacts
- Continuous voltage range (24-240 V AC/DC) or single-supply
- Setting and operation via front-face operating controls
- Adjustment of threshold values and switching hysteresis via direct reading scale
- Adjustable time delays
- Integrated and snap-fitted front-face marker label
- Sealable transparent cover (accessory)

CM-S range: Universal and multifunctional



- Only 22.5 mm wide housing
- Output contacts: 1 or 2 c/o (SPDT) contacts
- One supply voltage range or supplied by measuring circuit
- Setting and operation via front-face operating controls
- Adjustment of threshold values and switching hysteresis via direct reading scale
- Integrated and snap-fitted front-face marker
- Snap-on housing: The relays can be placed on a DIN rail tool-free - just snap it on or remove it tool-free
- Sealable transparent cover (accessory)

CM-E range: Economy



- Only 22.5 mm wide housing
- Output contacts: 1 c/o contact or 1 n/o contact
- One supply voltage range
- One monitoring function
- Cost-efficient solution for OEM applications
- Preset monitoring ranges

Certifications / Approvals

For certifications and approvals we kindly advise to go the documentation/download section on the product web pages that are referenced on the order pages.

ABB's measuring and monitoring relays in a new housing

Benefits at a glance

Easy Connect Technology

New options:

Additionally to the existing well established screw connections a new innovative connection technology can be offered: Easy Connect Technology with push-in terminals.

Tool-free wiring:

The push-in terminals can be wired with rigid or fine stranded wires with wire end ferrules totally tool-free. The connection direction is exactly the same as the screw version.

Higher utility class:

The Easy Connect Technology provides excellent vibration resistance with gas tight push-in terminals – the right solution for harsh environment.

Extended features

Flammability:

The plastic housing material used meets the requirements for the highest flammability class. (UL94 V-0 rated)

Look and feel:

The new housing fits perfectly with ABB's control products offer.

Measuring and monitoring relays

Benefits and advantages

Higher utility class ①

The Easy Connect Technology provides excellent vibration resistance with gas tight push-in terminals – the right solution for harsh environment. Selected products of the electronic timers and measuring and monitoring relays comply to the latest rail standards NF F 16-101/102, EN 45545, EN 50155 and more standards which are relevant for railway applications. Find more information in the rail brochure 2CDC110084B0201.

Safety ②

The “real distance” is hidden. The clearance and the creepage distances of our products exceed international standards and substantially increase the safety of our products.

Easy Connect Technology ③

Tool-free wiring and excellent vibration resistance. Push-in terminals provide connection of wires up to 2 x 0.5 - 1.5 mm² (2 x 20 -16 AWG), rigid or fine-strand with or without wire end ferrules. The extended type designators for products with push-in terminals are indicated by a **P** following the extended type designator e.g. CM-xxS.xx**P**.

Double-chamber cage connection terminals ④

Double-chamber cage connection terminals provide connection of wires up to 2 x 0.5-2.5 mm² (2 x 20-14 AWG) rigid or fine-strand, with or without wire end ferrules. Potential distribution does not require additional terminals. The extended type designators for products with double-chamber cage connection terminals are indicated by a **S** following the extended type designator e.g. CM-xxS.xx**S**.

LEDs for status indication ⑤

All actual operational states are displayed by front-face LEDs, thus simplifying commissioning and troubleshooting.

Integrated marker label ⑥

Integrated marker labels allow the product to be marked quickly and simply. No additional marker labels are required.

Sealable transparent cover ⑦

Protection against unauthorized changes of time and threshold values. Available as an accessory.

Snap-On housing ⑧

Tool-free DIN rail installation and deinstallation of the monitoring relay.

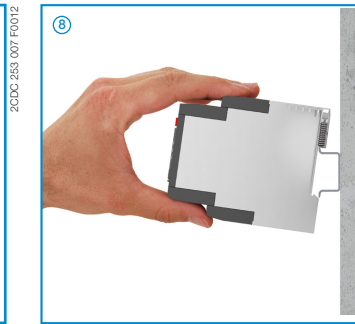
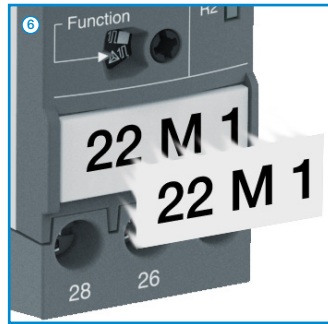
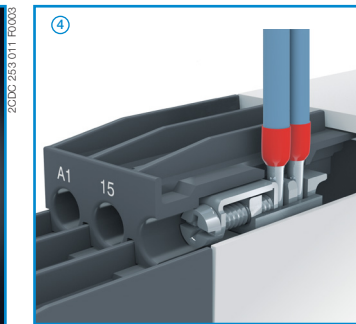
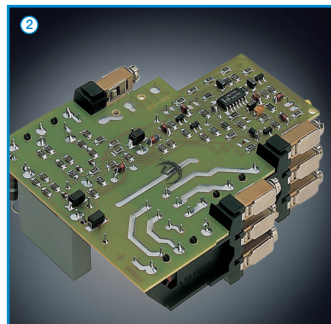
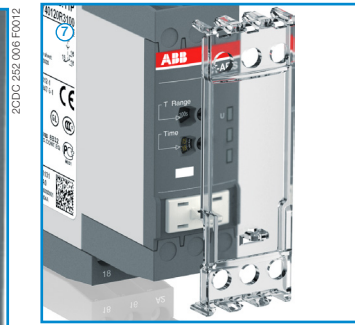
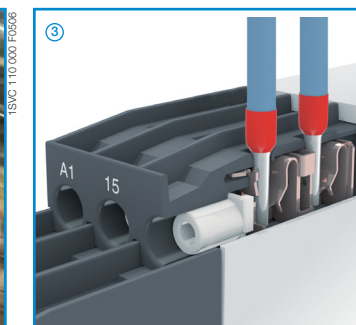
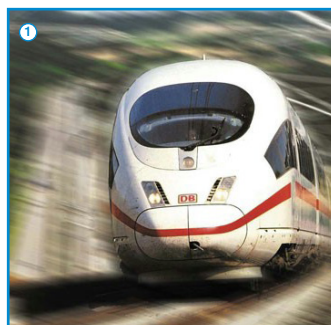

Measuring and monitoring relays

Assortment overview

2

Single-phase current and voltage monitoring

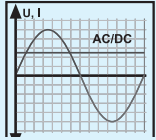

Current monitoring

- Monitoring of motor current consumption
- Monitoring of lighting installations and heating circuits
- Monitoring of transportation equipment overload
- Monitoring of locking devices, electromechanical brake gear and locked rotors

See “Ordering details - Current monitoring relays” on page 2/12.

Voltage monitoring

- Speed monitoring of DC motors
- Monitoring of battery voltages and other supply networks

See “Ordering details - Voltage monitoring relays” on page 2/14.

Three-phase monitoring

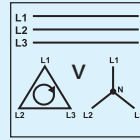

- Voltage monitoring of mobile three-phase equipment
- Protection of personnel and installations against phase reversal
- Monitoring of the supply voltage of machines and installations
- Protection of equipment against damage caused by unstable supply voltage
- Switching to emergency or auxiliary supply
- Protection of motors against damage caused by unbalanced phase voltages and phase loss

See “Ordering details - Singlefunctional” on page 2/30 or “Ordering details - Multifunctional” on page 2/32.

Grid feeding monitoring relays

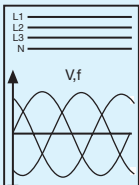

The CM-UFD.M* range monitors all voltage and frequency parameters in a grid and ensures the safe feeding of decentral produced electrical energy into the grid.

- Monitoring of the voltage with up to 2 thresholds for over- and undervoltage
- Monitoring of the frequency with up to 2 thresholds for over- and underfrequency
- ROCOF (rate of change of frequency) and vector shift detection
- In compliance with several local standards
- CM-UFD.M*M with Modbus RTU

See „Ordering details“ on page 50.

Insulation monitoring

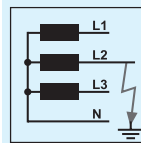

- Monitoring of electrically isolated supply mains for insulation resistance failure
- Detection of initial faults
- Protection against earth faults

See “Ordering details” on page 2/55.

Measuring and monitoring relays

Assortment overview

Thermistor motor protection

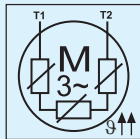

CM-MSE and CM-MSS provide full protection of motors with integrated PTC resistor sensors.

- Protection of motors against thermal overload, e. g. caused by insufficient cooling, heavy load starting conditions, undersized motors, etc.

See “Ordering details” on page 2/74.

Temperature monitoring

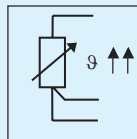

Acquisition, messaging and regulation of temperatures of solid, liquid and gaseous media in processes and machines

- Motor and system protection
- Control panel temperature monitoring
- Frost monitoring
- Temperature limits for process variables, e.g. in the packing or electroplating industry
- Control of systems and machines like heating, air-conditioning and ventilation systems, solar collectors, heat pumps or hot water supply systems
- Monitoring of servomotors with KTY sensors
- Bearing and gear oil monitoring
- Coolant monitoring

See “Ordering details” on page 2/87.

Liquid level monitoring and control

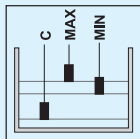

- Protection of pumps against dry running
- Protection against container overflow
- Control of liquid levels
- Detection of leaks
- Control of mixing ratios

See “Ordering details” on page 2/98.

Current and voltage monitoring relays, single-phase

Product group picture

2

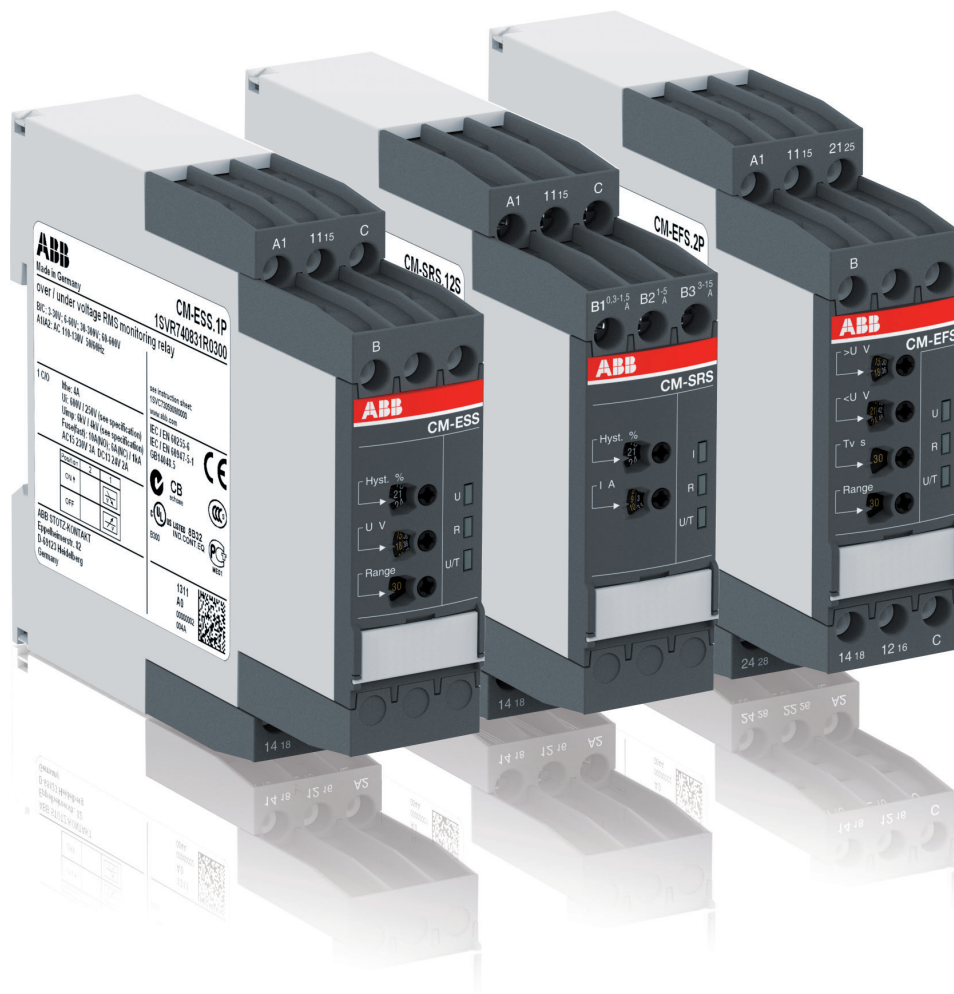

Current and voltage monitoring relays, single-phase

Table of contents

Current and voltage monitoring relays, single-phase

Benefits and advantages	2/9
Operating controls	2/10
Selection table - Current monitoring relays	2/11
Ordering details - Current monitoring relays	2/12
Selection table - Voltage monitoring relays	2/13
Ordering details - Voltage monitoring relays	2/14
Function diagrams	2/15
Connection diagrams, DIP switches	2/18
Technical data - Current monitoring relays	2/20
Technical data - Voltage monitoring relays	2/22

Current and voltage monitoring relays, single-phase

Benefits and advantages

2

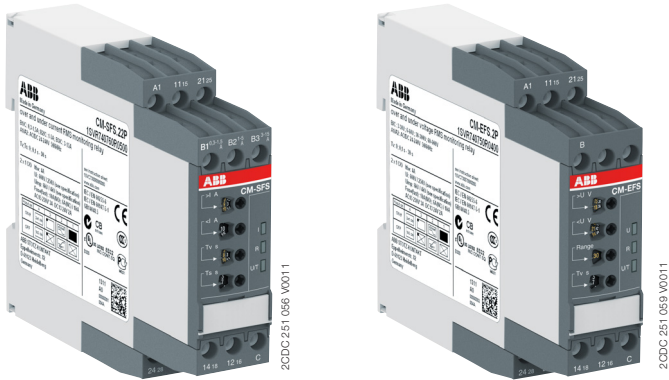

Characteristics current and voltage monitoring relays ¹⁾

- Monitoring of DC and AC currents: 3 mA to 15 A
- Monitoring of DC and AC voltages from 3-600 V
- Suitable for railway applications
- TRMS measuring principle
- Device with 3 or 3 measuring ranges
- Over- and undercurrent monitoring
- Over- and undervoltage monitoring
- ON or OFF-delay configurable
- Open- or closed-circuit principle configurable
- Threshold values for >U and/or <U adjustable
- Latching function configurable
- Thresholds for >I and/or <I adjustable
- Fixed hysteresis of 5 %
- Start-up delay T_v adjustable 0; 0.1-30 s
- Tripping delay T_v adjustable 0; 0.1-30 s
- 1 x 2 c/o contacts (common signal) or 2 x 1 c/o contact (separate signals for >I and <I) configurable
- 1 x 2 c/o contacts (common signal) or 2 x 1 c/o contact (separate signals for >U and <U) configurable
- 22.5 mm width
- 3 LEDs for the indication of operational states
- Various approvals and marks

¹⁾ depending on device

Current monitoring, single-phase

The ABB current monitoring relays CM-SRS.xx reliably monitor the occurrence of currents that exceed or fall below the selected threshold value. The functions overcurrent or undercurrent monitoring can be preselected. Single- and multifunction devices for the monitoring of direct or alternating currents from 3 mA to 15 A are available.

Current window monitoring (I_{min} , I_{max})

The window monitoring relay CM-SFS.2x is available if the application requires the simultaneous monitoring of over- and undercurrents.

Voltage monitoring, single-phase

The ABB voltage monitoring relays CM-SRS.xx are used to monitor direct and alternating voltages within a range of 3-600 V. Over- or undervoltage detection can be preselected.

Voltage window monitoring (U_{min} , U_{max})

For the simultaneous detection of over- and undervoltages, the window monitoring relay CM-EFS.2 can be used.

Current and voltage monitoring relays, single-phase

Operating controls

Current monitoring relays

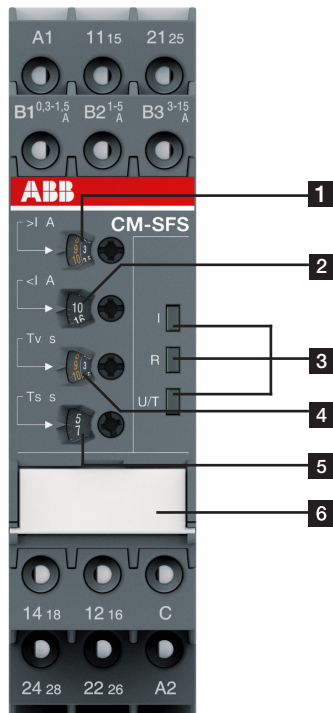

- 1** Adjustment of the threshold value $>I$ for overcurrent
- 2** Adjustment of the threshold value $<I$ for undercurrent
- 3** Indication of operational states
U/T: green LED – control supply voltage/timing
R: yellow LED – relay status
I: red LED – over- / undercurrent
- 4** Adjustment of the tripping delay T_v
- 5** Adjustment of the start-up delay T_s
- 6** DIP switches (see DIP switch functions on page 2/20)
 - ON-delay
 - OFF-delay
 - Closed-circuit principle
 - Open-circuit principle
 - Latching function activated
 - Latching function not activated
 - 2x1 c/o (SPDT) contact
 - 1x2 c/o (SPDT) contacts

Voltage monitoring relays

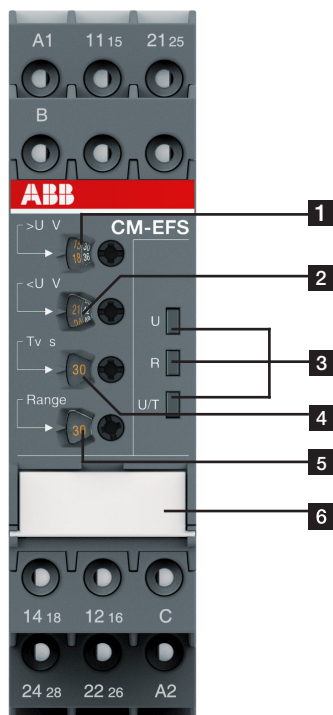

- 1** Adjustment of the threshold value $>U$ for overvoltage
- 2** Adjustment of the threshold value $<U$ for undervoltage
- 3** Indication of operational states
U/T: green LED – control supply voltage/timing
R: yellow LED – relay status
U: red LED – over- / undervoltage
- 4** Adjustment of the tripping delay T_v
- 5** Adjustment of the measuring range
- 6** DIP switches (see DIP switch functions on page 2/20)
 - ON-delay
 - OFF-delay
 - Closed-circuit principle
 - Open-circuit principle
 - Latching function activated
 - Latching function not activated
 - 2x1 c/o (SPDT) contact
 - 1x2 c/o (SPDT) contacts

Current and voltage monitoring relays, single-phase

Selection table - Current monitoring relays

Type	Order number	1	2	3	4	5	6	7	8	9	10	11	12	13	14	15	16	17	18	19	20	21	22	23	24
CM-SFS.11S	1SVR730840R0200																								
CM-SFS.11P	1SVR740840R0200																								
CM-SFS.11S	1SVR730841R0200																								
CM-SFS.11P	1SVR740841R0200																								
CM-SFS.11S	1SVR730841R1200																								
CM-SFS.11P	1SVR740841R1200																								
CM-SFS.12S	1SVR730840R0300																								
CM-SFS.12S	1SVR730841R0300																								
CM-SFS.12S	1SVR730841R1300																								
CM-SFS.21S	1SVR730840R0400																								
CM-SFS.21P	1SVR740840R0400																								
CM-SFS.21S	1SVR730841R0400																								
CM-SFS.21P	1SVR740841R0400																								
CM-SFS.21S	1SVR730841R1400																								
CM-SFS.21P	1SVR740841R1400																								
CM-SFS.22S	1SVR730840R0500																								
CM-SFS.22S	1SVR730841R0500																								
CM-SFS.22S	1SVR730841R1500																								
CM-SFS.M1S	1SVR730840R0600																								
CM-SFS.M1P	1SVR740840R0600																								
CM-SFS.M2S	1SVR730840R0700																								
CM-SFS.21S	1SVR730760R0400																								
CM-SFS.21P	1SVR740760R0400																								
CM-SFS.22S	1SVR730760R0500																								

Rated control supply voltage U _s	1	2	3	4	5	6	7	8	9	10	11	12	13	14	15	16	17	18	19	20	21	22	23	24
24 - 240 V AC/DC	■	■																						
110 - 130 V AC			■	■																				
220 - 240 V AC					■	■																		

Measuring ranges AC/DC	1	2	3	4	5	6	7	8	9	10	11	12	13	14	15	16	17	18	19	20	21	22	23	24
3 - 30 mA	■	■	■	■	■	■																		
10 - 100 mA	■	■	■	■	■	■																		
0.1 - 1 A	■	■	■	■	■	■																		
0.3 - 1.5 A							■	■	■															
1 - 5 A							■	■	■															
3 - 15 A							■	■	■															

Monitoring function	1	2	3	4	5	6	7	8	9	10	11	12	13	14	15	16	17	18	19	20	21	22	23	24	
Over- or undercurrent	■	■	■	■	■	■	■	■	■	■	■	■	■	■	■	■	■	■	■	■	■	■	■	■	
Window current monitoring																							■	■	■
Latching																						sel	sel	sel	sel
Open-circuit or closed-circuit principle																						sel	sel	sel	sel

Timing functions for tripping delay	1	2	3	4	5	6	7	8	9	10	11	12	13	14	15	16	17	18	19	20	21	22	23	24	
ON-delay, 0.1 - 30 s																									
ON- or OFF-delay, 0.1 - 30 s																									

Output	1	2	3	4	5	6	7	8	9	10	11	12	13	14	15	16	17	18	19	20	21	22	23	24
c/o contact	1	1	1	1	1	1	1	1	1	2	2	2	2	2	2	2	2	2	2	2	2	2	2	2

Connection type	1	2	3	4	5	6	7	8	9	10	11	12	13	14	15	16	17	18	19	20	21	22	23	24
Push-in terminals		■		■		■		■		■		■		■		■		■		■		■		■
Double-chamber cage connection terminals	■		■		■		■		■		■		■		■		■		■		■		■	

adj: adjustable
sel: selectable

Current and voltage monitoring relays, single-phase

Ordering details - Current monitoring relays



CM-SRS.22S

2C3DC 251 054 V0011



CM-SFS.22P

2C3DC 251 056 V0011

Description

The CM range current monitoring relays protect single-phase mains (DC or AC) from over- and undercurrent from 3 mA to 15 A.

Ordering details

Description	Type	Order code	Price 1 pc	Weight (1 pc) kg (lb)
		1SVR730840R0200		0.145 (0.320)
	CM-SRS.11S	1SVR730841R0200		0.161 (0.355)
		1SVR730841R1200		0.161 (0.355)
	CM-SRS.11P	1SVR740840R0200		0.137 (0.302)
		1SVR740841R0200		0.153 (0.337)
		1SVR740841R1200		0.153 (0.337)
	CM-SRS.12S	1SVR730840R0300		0.137 (0.302)
		1SVR730841R0300		0.168 (0.370)
		1SVR730841R1300		0.168 (0.370)
	CM-SRS.21S	1SVR730840R0400		0.152 (0.335)
		1SVR730841R0400		0.179 (0.395)
		1SVR730841R1400		0.179 (0.395)
	CM-SRS.21P	1SVR740840R0400		0.141 (0.311)
		1SVR740841R0400		0.168 (0.370)
		1SVR740841R1400		0.168 (0.370)
	CM-SRS.22S	1SVR730840R0500		0.144 (0.399)
		1SVR730841R0500		0.181 (0.399)
		1SVR730841R1500		0.181 (0.399)
	CM-SRS.M1S	1SVR730840R0600		0.153 (0.337)
	CM-SRS.M1P	1SVR740840R0600		0.142 (0.313)
	CM-SRS.M2S	1SVR730840R0700		0.155 (0.342)
	CM-SFS.21S	1SVR730760R0400		0.150 (0.331)
	CM-SFS.21P	1SVR740760R0400		0.139 (0.306)
	CM-SFS.22S	1SVR730760R0500		0.158 (0.348)

See "Selection table - Current monitoring relays" on page 2/11.

S: screw connection
P: push-in connection



Further documentation single-phase monitoring relays on www.abb.com

Current and voltage monitoring relays, single-phase

Selection table - Voltage monitoring relays

2

Type	Order number	1SVR730830R0300	1SVR740830R0300	1SVR730831R0300	1SVR740831R0300	1SVR730831R1300	1SVR740831R1300	1SVR730830R0400	1SVR740830R0400	1SVR730831R0400	1SVR740831R0400	1SVR730831R1400	1SVR740831R1400	1SVR730830R0500	1SVR740830R0500	1SVR730750R0400	1SVR740750R0400
Rated control supply voltage U_s																	
24 - 240 V AC/DC		■	■					■	■					■	■	■	■
110 - 130 V AC			■	■					■	■							
220 - 240 V AC					■	■					■	■					
Measuring ranges AC/DC																	
3 - 30 V		■	■	■	■	■	■	■	■	■	■	■	■	■	■	■	■
6 - 60 V		■	■	■	■	■	■	■	■	■	■	■	■	■	■	■	■
30 - 300 V		■	■	■	■	■	■	■	■	■	■	■	■	■	■	■	■
60 - 600 V		■	■	■	■	■	■	■	■	■	■	■	■	■	■	■	■
Monitoring function																	
Over- or undervoltage		■	■	■	■	■	■	■	■	■	■	■	■	■	■	■	■
Windows voltage monitoring																■	■
Latching														sel	sel	sel	sel
Open-circuit or closed-circuit principle														sel	sel	sel	sel
Timing functions for tripping delay																	
ON-delay, 0.1 - 30 s								adj	adj	adj	adj	adj	adj	adj	adj		
ON- or OFF-delay, 0.1 - 30 s																sel	sel
Output																	
c/o contact		1	1	1	1	1	1	2	2	2	2	2	2	2	2	2	2
Connection type																	
Push-in terminals			■		■		■		■		■		■		■		■
Double-chamber cage connection terminals		■		■		■		■		■		■		■		■	

adj: adjustable
sel: selectable

Current and voltage monitoring relays, single-phase

Ordering details - Voltage monitoring relays

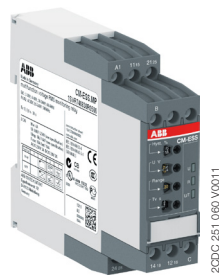

CM-ESS.MP

2C3DC 251 059 V0011

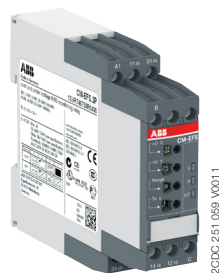

CM-EFS.2

2C3DC 251 059 V0011

Description

The CM range voltage monitoring relays provide reliable monitoring of voltages as well as detection of phase loss in single-phase mains.

Ordering details

Description	Type	Order code	Price 1 pc	Weight (1 pc) kg (lb)
	CM-ESS.1S	1SVR730830R0300		0.135 (0.298)
		1SVR730831R0300		0.164 (0.362)
	CM-ESS.1P	1SVR730831R1300		0.164 (0.362)
		1SVR740830R0300		0.126 (0.278)
	CM-ESS.1P	1SVR740831R0300		0.155 (0.342)
		1SVR740831R1300		0.155 (0.342)
	CM-ESS.2S	1SVR730830R0400		0.153 (0.337)
		1SVR730831R0400		0.181 (0.399)
	CM-ESS.2S	1SVR730831R1400		0.181 (0.399)
		1SVR740830R0400		0.142 (0.313)
	CM-ESS.2P	1SVR740831R0400		0.170 (0.375)
		1SVR740831R1400		0.170 (0.375)
	CM-ESS.MS	1SVR730830R0500		0.154 (0.340)
	CM-ESS.MP	1SVR740830R0500		0.143 (0.320)
	CM-EFS.2S	1SVR730750R0400		0.157 (0.346)
	CM-EFS.2P	1SVR740750R0400		0.146 (0.322)

See "Selection table - Voltage monitoring relays" on page 2/13.

S: screw connection
P: push-in connection



Further documentation single-phase monitoring relays on www.abb.com

Current and voltage monitoring relays, single-phase Function diagrams

Function diagrams - CM-SRS.1

Overcurrent monitoring

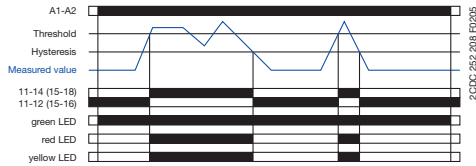

Function diagrams - CM-SRS.2

Overcurrent monitoring

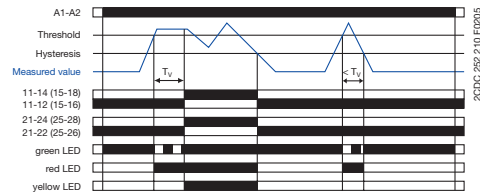

Undercurrent monitoring

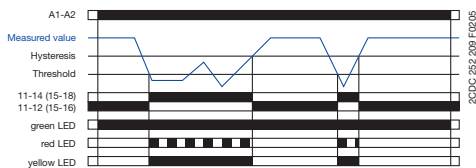

Undercurrent monitoring

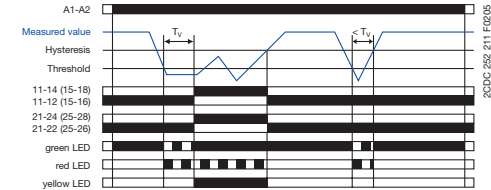

If the measured value exceeds resp. drops below the adjusted threshold value, the output relay(s) energize(s): on the CM-SRS.1 immediately, on the CM-SRS.2 after the set tripping delay T_V . If the measured value exceeds resp. drops below the threshold value plus resp. minus the adjusted hysteresis, the output relay(s) de-energize(s). The hysteresis is adjustable within a range of 3-30 % of the threshold value.

Function diagrams - CM-SRS.M

Overcurrent monitoring without latching

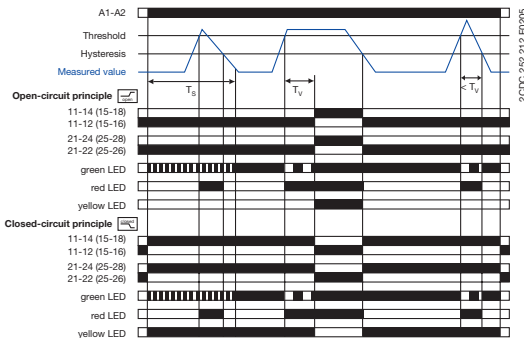

Undercurrent monitoring without latching

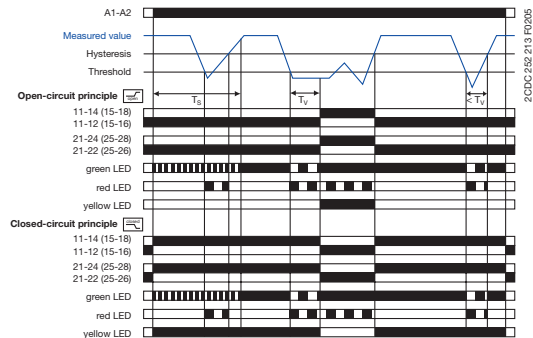

Overcurrent monitoring with latching

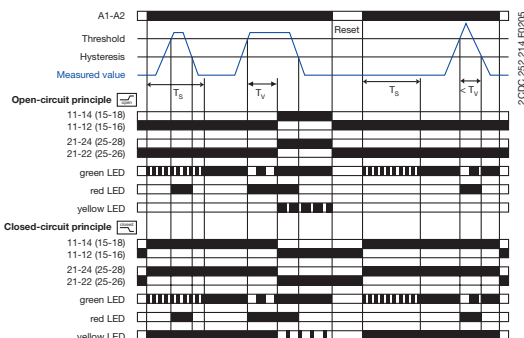

Undercurrent monitoring with latching

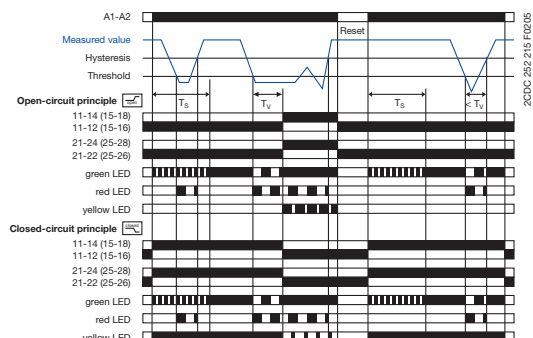

If the measured value exceeds resp. drops below the adjusted threshold value before the set start-up delay T_S is complete, the output relays do not change their actual state. If the measured value exceeds resp. drops below the adjusted threshold value when T_S is complete, the tripping delay T_V starts. If T_V is complete and the measured value is still exceeding resp. below the threshold value plus resp. minus the set hysteresis, the output relays energize / de-energize .

If the measured value exceeds resp. drops below the threshold value minus resp. plus the set hysteresis and the latching function is not activated , the output relays de-energize / energize . With activated latching function the output relays remain energized and de-energize only, when the supply voltage is interrupted / the output relays remain de-energized and energize only, when the supply voltage is switched off and then again switched on = Reset.

The hysteresis is adjustable within a range of 3-30 % of the threshold value.

Current and voltage monitoring relays, single-phase

Function diagrams

Function diagrams - CM-SFS.2

Current window monitoring 1x2 c/o contact 1x2 c/o

ON-delayed without latching

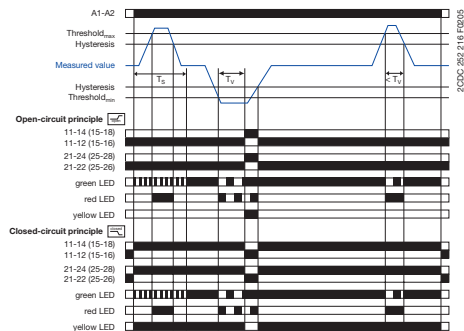

Further function diagrams see data sheet.

ON-delayed current window monitoring with parallel switching c/o contacts 1x2 c/o:

If the measured value exceeds resp. drops below the adjusted threshold value before the set start-up delay T_s is complete, the output relays do not change their actual state.

If the measured value exceeds resp. drops below the adjusted threshold value when T_s is complete, the tripping delay T_v starts, when is configured. If T_v is complete and the measured value is still exceeding resp. below the threshold value minus resp. plus the fixed hysteresis (5%), the output relays energize /de-energize .

If the measured value exceeds resp. drops below the threshold value plus resp. minus the hysteresis and the latching function is not activated , the output relays de-energize / energize . With activated latching function the output relays remain energized and de-energize only, when the supply voltage is interrupted / the output relays remain de-energized and energize only, when the supply voltage is switched off and then again switched on = Reset.

Current window monitoring 1x2 c/o contact 1x2 c/o

OFF-delayed without latching

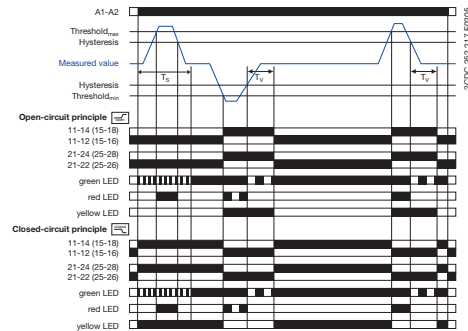

OFF-delayed current window monitoring with parallel switching c/o contacts 1x2 c/o:

If the measured value exceeds resp. drops below the adjusted threshold value when the set start-up delay T_s is complete, the output relays energize / de-energize , when is configured, and remain in this position during the set tripping delay T_v . If the measured value exceeds resp. drops below the threshold value plus resp. minus the fixed hysteresis (5%) and the latching function is not activated , the tripping delay T_v starts. After completion of T_v the output relays de-energize / energize , provided that the latching function is not activated . With activated latching function the output relays remain energized and de-energize only, when the supply voltage is interrupted / the output relays remain de-energized and energize only, when the supply voltage is switched off and then again switched on = Reset. When is adjusted on the device, the functionality is equivalent to the one described above. There is only to consider that in this case, instead of both output relays, only one output relay each will be switched.

$$">I" = 11_{15}-12_{16}/14_{18}; "<I" = 21_{25}-22_{26}/24_{28}$$

Function diagrams - CM-ESS.1

Overvoltage monitoring

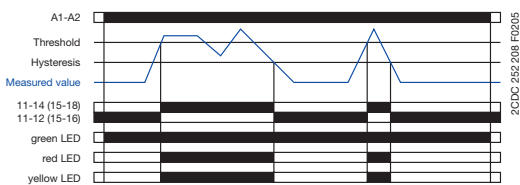

Undervoltage monitoring

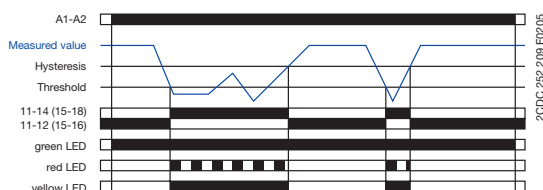

Function diagrams - CM-ESS.2

Overvoltage monitoring

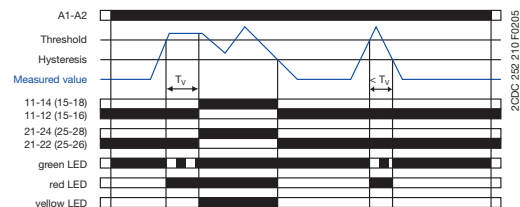

Undervoltage monitoring

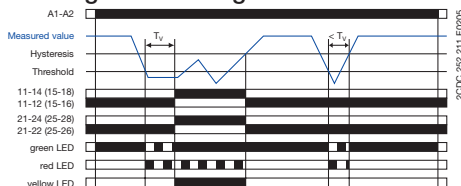

Depending on the configuration, the voltage monitoring relays CM-ESS.1 and CM-ESS.2 can be used for over- or undervoltage monitoring in single-phase AC and/or DC systems. The voltage to be monitored (measured value) is applied to terminals B-C. The devices work according the open-circuit principle. If the measured value exceeds resp. drops below the adjusted threshold value, the output relay(s) energize(s): on the CM-ESS.1 immediately, on the CM-ESS.2 after the set tripping delay T_v . If the measured value exceeds resp. drops below the threshold value plus resp. minus the adjusted hysteresis, the output relay(s) de-energize(s). The hysteresis is adjustable within a range of 3-30 % of the threshold value.

Current and voltage monitoring relays, single-phase

Function diagrams

Function diagrams - CM-ESS.M

Overvoltage monitoring without latching

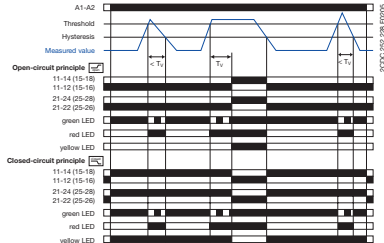

Undervoltage monitoring without latching

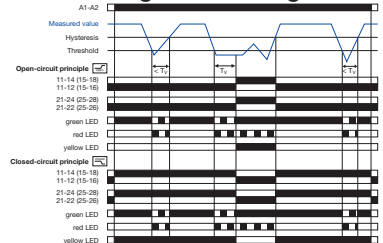



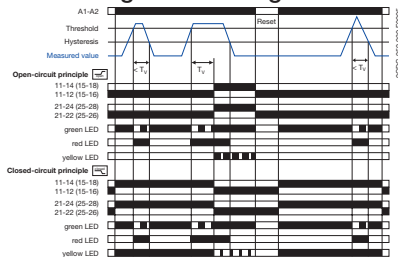



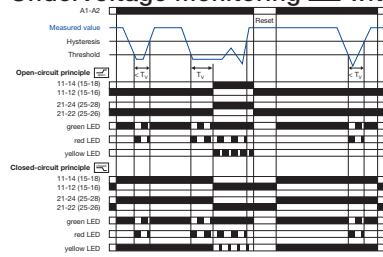

Overvoltage monitoring with latching



Undervoltage monitoring without latching



If the measured value exceeds resp. drops below the adjusted threshold value, the tripping delay T_V starts. If T_V is complete and the measured value is still exceeding resp. below the threshold value plus resp. minus the set hysteresis, the output relays energize  / de-energize .

If the measured value exceeds resp. drops below the threshold value plus resp. minus the set hysteresis and the latching function is not activated , the output relays de-energize  / energize . With activated latching function  the output relays remain energized  and de-energize only, when the supply voltage is interrupted / the output relays remain de-energized  and energize only, when the supply voltage is switched off and then again switched on = Reset. The hysteresis is adjustable within a range of 3-30 % of the threshold value.



Further function diagrams see data sheet.



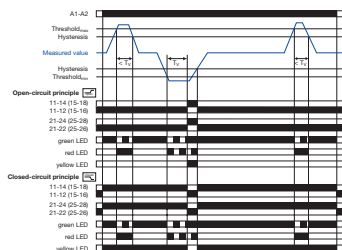



Voltage window monitoring 1x2 c/o contact

ON-delayed without latching



ON-delayed voltage window monitoring with parallel switching c/o contacts

If the measured value exceeds resp. drops below the adjusted threshold value, the tripping delay T_V starts, when  is configured. If T_V is complete and the measured value is still exceeding resp. below the threshold value minus resp. plus the fixed hysteresis (5%), the output relays energize  /de-energize .



If the measured value exceeds resp. drops below the threshold value plus resp. minus the hysteresis and the latching function is not activated , the output relays de-energize  / energize . With activated latching function  the output relays remain energized  and de-energize only, when the supply voltage is interrupted / the output relays remain de-energized  and energize only, when the supply voltage is switched off and then again switched on = Reset.





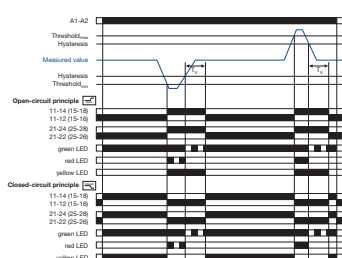

OFF-delayed voltage window monitoring with parallel switching c/o contacts

Voltage window monitoring 1x2 c/o contact

OFF-delayed without latching



If the measured value exceeds resp. drops below the adjusted threshold value, the output relays energize  / de-energize , when  is configured, and remain in this position during the set tripping delay T_V .

If the measured value exceeds resp. drops below the threshold value plus resp. minus the fixed hysteresis (5%) and the latching function is not activated , the tripping delay T_V starts. After completion of T_V , the output relays de-energize  / energize , provided that the latching function is not activated . With activated latching function  the output relays remain energized  and de-energize only, when the supply voltage is interrupted / the output relays remain de-energized  and energize only, when the supply voltage is switched off and then again switched on = Reset.

When  is adjusted on the device, the functionality is equivalent to the one described above. There is only to consider that in this case, instead of both output relays, only one output relay each will be switched.

$$">U" = 11_{15}-12_{16}/14_{18}; "<U" = 21_{25}-22_{26}/24_{28}$$

Current and voltage monitoring relays, single-phase

Connection diagrams, DIP switches

Connection diagram CM-SRS.1, CM-SRS.2

A1	11 ₁₅	C
B1	B2	B3

A1	11 ₁₅	21 ₂₅
B1	B2	B3

2CDC 252 204 F0005 2CDC 252 205 F0005

A1-A2 Control supply voltage
 B1-C Measuring range 1: 3-30 mA or 0.3-1.5 A
 B2-C Measuring range 2: 10-100 mA or 1-5 A
 B3-C Measuring range 3: 0.1-1 A or 3-15 A
 11₁₅-12₁₆/14₁₈ Output contacts - open-circuit principle
 21₂₅-22₂₆/24₂₈

DIP switch functions CM-SRS.1, CM-SRS.2

Position	2	1
ON ↑		
OFF		

2CDC 252 272 F0005

1 ON Undercurrent monitoring
 OFF Overcurrent monitoring

OFF = Default

Connection diagram CM-SRS.M

A1	11 ₁₅	21 ₂₅
B1	B2	B3

A1-A2	Control supply voltage
B1-C	Measuring range 1: 3-30 mA or 0.3-1.5 A
B2-C	Measuring range 2: 10-100 mA or 1-5 A
B3-C	Measuring range 3: 0.1-1 A or 3-15 A
11 ₁₅ -12 ₁₆ /14 ₁₈	Output contacts - open- or closed circuit principle
21 ₂₅ -22 ₂₆ /24 ₂₈	

2CDC 252 205 F0005

DIP switch functions CM-SRS.M

Position	4	3	2	1
ON ↑				
OFF				

2CDC 252 273 F0005

1 ON Undercurrent monitoring
 OFF Overcurrent monitoring
 2 ON Closed-circuit principle
 OFF Open-circuit principle
 3 ON Latching function activated
 OFF Latching function not activated
 OFF = Default

Connection diagram CM-SFS.2

A1	11 ₁₅	21 ₂₅
B1	B2	B3

A1-A2	Control supply voltage
B1-C	Measuring range 1: 3-30 mA or 0.3-1.5 A
B2-C	Measuring range 2: 10-100 mA or 1-5 A
B3-C	Measuring range 3: 0.1-1 A or 3-15 A
11 ₁₅ -12 ₁₆ /14 ₁₈	Output contacts - open- or closed circuit principle
21 ₂₅ -22 ₂₆ /24 ₂₈	

2CDC 252 205 F0005

DIP switch function CM-SFS.2

Position	4	3	2	1
ON ↑				
OFF				

2CDC 252 274 F0005

1 ON OFF-delay
 OFF ON-delay
 2 ON Closed-circuit principle
 OFF Open-circuit principle
 3 ON Latching function activated
 OFF Latching function not activated
 4 ON 2x1 c/o contact
 OFF 1x2 c/o contacts
 OFF = Default

Connection diagram CM-ESS.M

A1	11 ₁₅	21 ₂₅
B		

A1-A2	Control supply voltage
B-C	Measuring ranges AC/DC: 3-30 V; 6-60 V 30-300 V; 60-600 V
11 ₁₅ -12 ₁₆ /14 ₁₈	Output contacts - open- or closed circuit principle
21 ₂₅ -22 ₂₆ /24 ₂₈	

2CDC 252 207 F0005

DIP switch functions CM-ESS.M

Position	4	3	2	1
ON ↑				
OFF				

2CDC 252 276 F0005

1 ON Undervoltage monitoring
 OFF Overvoltage monitoring
 2 ON Closed-circuit principle
 OFF Open-circuit principle
 3 ON Latching function activated
 OFF Latching function not activated
 OFF = Default

Current and voltage monitoring relays, single-phase

Connection diagrams, DIP switches

2

Connection diagram CM-ESS.1, CM-ESS.2

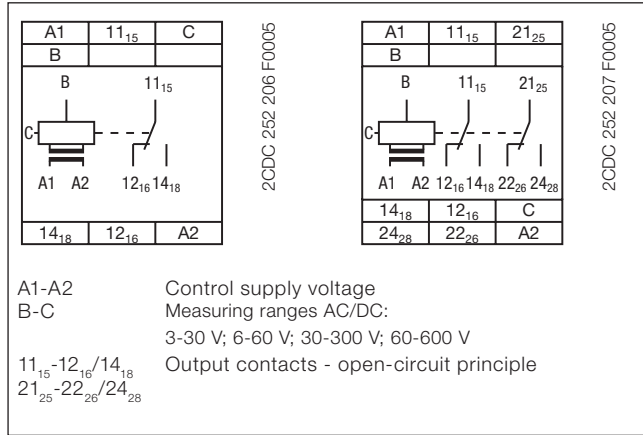

DIP switch functions CM-ESS.1, CM-ESS.2

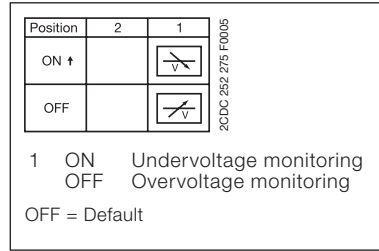

Connection diagram CM-EFS.2

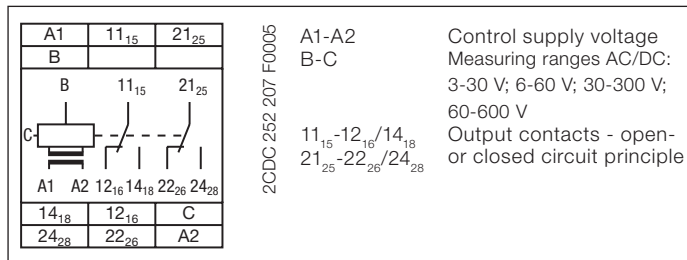



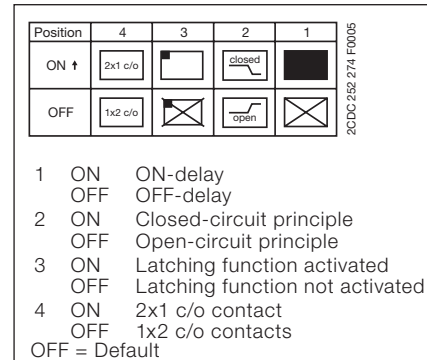





DIP switch functions CM-EFS.2







Current monitoring relays, single-phase

Technical data - Current monitoring relays

Type		CM-SRS.1	CM-SRS.2	CM-SRS.M	CM-SFS.2	
Input circuit - Supply circuit		A1-A2				
Rated control supply voltage U_s	A1-A2	110-130 V AC				
	A1-A2	220-240 V AC				
	A1-A2	24-240 V AC/DC				
Rated control supply voltage U_s tolerance		-15...+10 %				
Rated frequency	AC versions	50/60 Hz				
	AC/DC versions	50/60 Hz or DC				
Current / power consumption		see data sheets				
Power failure buffering time		20 ms				
Transient overvoltage protection		Varistors				
Input circuit - Measuring circuit		B1/B2/B3-C				
Monitoring function		over- or undercurrent monitoring configurable			over- and under- current monitoring	
Measuring method		true RMS measuring principle				
Measuring inputs		CM-SxS.x1			CM-SxS.x2	
	terminal connection	B1-C	B2-C	B3-C	B1-C	B2-C
	measuring ranges AC/DC	3-30 mA	10-100 mA	0.1-1 A	0.3-1.5 A	1-5 A
	input resistance	3.3 Ω	1 Ω	0.1 Ω	0.05 Ω	0.01 Ω
	pulse overload capacity $t < 1$ s	500 mA	1 A	10 A	15 A	50 A
	continuous capacity	50 mA	150 mA	1.5 A	2 A	7 A
Threshold value(s)		adjustable within the indicated measuring range				
Tolerance of the adjusted threshold value		10 % of full-scale value				
Hysteresis related to the threshold value		3-30 % adjustable				
Measuring signal frequency range		DC / 15 Hz - 2 kHz				
Rated measuring signal frequency range		DC / 50-60 Hz				
Maximum response time		AC: 80 ms / DC: 120 ms				
Accuracy within the control supply voltage tolerance		$\Delta U \leq 0.5$ %				
Accuracy within the temperature range		$\Delta U \leq 0.06$ % / $^{\circ}\text{C}$				
Timing circuit						
Start-up delay T_s		none	0 or 0.1-30 s adjustable			
Tripping delay T_v		none	0 or 0.1-30 s adjustable			
Repeat accuracy (constant parameters)		± 0.07 % of full-scale value				
Accuracy within the control supply voltage tolerance		-	$\Delta t \leq 0.5$ %			
Accuracy within the temperature range		-	$\Delta t \leq 0.06$ % / $^{\circ}\text{C}$			
Indication of operational states						
Control supply voltage	U/T: green LED	 : control supply voltage applied,  : start-up delay T_s active,  : tripping delay T_v active				
Measured value	I: red LED	 : overcurrent,  : undercurrent				
Relay status	R: yellow LED	 : relay energized, no latching function  : relay energized, active latching function  : relay de-energized, active latching function				
Output circuits		11(15)-12(16)/14(18), 21(25)-22(26)/24(28) - Relays				
Kind of output		1 c/o contact	2 c/o contacts	1x2 c/o contacts or 2x1 c/o contact configurable		
Operating principle		open-circuit principle ²⁾			open- or closed-circuit principle configurable ²⁾	
Contact material		AgNi				
Minimum switching voltage / minimum switching current		24 V / 10 mA				
Maximum switching voltage / maximum switching current		250 V AC / 4 A AC				
Rated operational voltage U_e	AC-12 (resistive) at 230 V	4 A				
and rated operational current I_e	AC-15 (inductive) at 230 V	3 A				
	DC-12 (resistive) at 24 V	4 A				
	DC-13 (inductive) at 24 V	2 A				
AC rating (UL 508)	utilization category (Control Circuit Rating Code)	B 300				
	max. rated operational voltage	300 V AC				
	max. continuous thermal current at B 300	5 A				
	max. making/breaking apparent power (make/break) at B 300	3600/360 VA				
Mechanical lifetime		30x10 ⁶ switching cycles				
Electrical lifetime (AC-12, 230 V, 4 A)		0.1x10 ⁶ switching cycles				
Max. fuse rating to achieve short-circuit protection	n/c contact	6 A fast-acting	10 A fast-acting	6 A fast-acting		
	n/o contact	10 A fast-acting				

¹⁾ In case of measured currents > 10 A, lateral spacing has to be min. 10 mm

²⁾ Open-circuit principle: output relay energizes if the measured value exceeds  / falls below  the adjusted threshold value
 Closed-circuit principle: output relay de-energizes if measured value exceeds  / falls below  the adjusted threshold value

Current monitoring relays, single-phase

Technical data - Current monitoring relays







2





Type	CM-SRS.1	CM-SRS.2	CM-SRS.M	CM-SFS.2
General data				
MTBF	on request			
Duty cycle	100%			
Dimensions	see 'Dimensional drawings'			
Mounting	DIN rail (IEC/EN 60715), snap-on mounting without any tool			
Mounting position	any			
Minimum distance to other units	10 mm (0.39 in) at measured current > 10 A			
Material of housing	UL 94 V-0			
Degree of protection	housing / terminals	IP50 / IP20		
Electrical connection				
Connecting capacity	Screw connection technology		Easy Connect Technology (Push-in)	
fine-strand with(out) wire end ferrule	1 x 0.5-2.5 mm ² (1 x 18-14 AWG) 2 x 0.5-1.5 mm ² (2 x 18-16 AWG)		2 x 0.5-1.5 mm ² (2 x 18-16 AWG)	
rigid	1 x 0.5-4 mm ² (1 x 20-12 AWG) 2 x 0.5-2.5 mm ² (2 x 20-14 AWG)		2 x 0.5-1.5 mm ² (2 x 20-16 AWG)	
Stripping length	8 mm (0.32 in)			
Tightening torque	0.6-0.8 Nm (7.08 lb.in)		-	
Environmental data				
Ambient temperature range	operation	-20...+60 °C		
	storage	40...+85 °C		
Damp heat (IEC/EN 60068-2-30)	55 °C, 6 cycles			
Vibration, sinusoidal	class 2			
Shock	class 2			
Isolation data				
Rated insulation voltage	input / measuring circuit / output	600 V		
	output 1 / output 2	250 V		
Rated impulse withstand voltage U _{imp}	input / measuring circuit / output	6 kV 1.2/50 μs		
	output 1 / output 2	4 kV 1.2/50 μs		
Pollution degree	3			
Overvoltage category	III			
Standards / Directives				
Standards	IEC/EN 60255-27, IEC/EN 60947-5-1, EN 50178			
Low Voltage Directive	2014/35/EU			
EMC Directive	2014/30/EU			
RoHS Directive	2011/65/EU			
Electromagnetic compatibility				
Interference immunity to	IEC/EN 61000-6-2			
electrostatic discharge	IEC/EN 61000-4-2	level 3		
radiated, radio-frequency, electromagnetic field	IEC/EN 61000-4-3	level 3		
electrical fast transient / burst	IEC/EN 61000-4-4	level 3		
surge	IEC/EN 61000-4-5	level 3		
conducted disturbances, induced by radio-frequency fields	IEC/EN 61000-4-6	level 3		
Interference emission	IEC/EN 61000-6-3			
high-frequency radiated	IEC/CISPR 22; EN 55022	class B		
high-frequency conducted	IEC/CISPR 22; EN 55022	class B		

Voltage monitoring relays, single-phase

Technical data - Voltage monitoring relays

2

Type		CM-ESS.1	CM-ESS.2	CM-ESS.M	CM-EFS.2
Input circuit - Supply circuit		A1-A2			
Rated control supply voltage U_s	A1-A2	110-130 V AC			
	A1-A2	220-240 V AC			
	A1-A2	24-240 V AC/DC			
Rated control supply voltage U_s tolerance		-15...+10 %			
Rated frequency	AC versions	50/60 Hz			
	AC/DC versions	50/60 Hz or DC			
Current / power consumption		see data sheet			
Power failure buffering time		20 ms			
Transient overvoltage protection		varistors			
Input circuit - Measuring circuit		B-C			
Monitoring function		over- or undervoltage monitoring configurable		over- and undervoltage monitoring configurable	
Measuring method		true RMS measuring principle			
Measuring inputs		CM-ExS			
	terminal connection	B-C	B-C	B-C	B-C
	measuring range AC/DC	3-30 V	6-60 V	30-300 V	60-600 V
	input resistance	600 k Ω	600 k Ω	600 k Ω	600 k Ω
	pulse overload capacity $t < 1$ s	800 V	800 V	800 V	800 V
	continuous capacity	660 V	660 V	660 V	660 V
Threshold value(s)		adjustable within the indicated measuring range			
Tolerance of the adjusted threshold value		10 % of full-scale value			
Hysteresis related to the threshold value		3-30 % adjustable			5 % fixed
Measuring signal frequency range		DC / 15 Hz - 2 kHz			
Rated measuring signal frequency range		DC / 50-60 Hz			
Maximum response time		AC: 80 ms / DC: 120 ms			
Accuracy within the control supply voltage tolerance		$\Delta U \leq 0.5$ %			
Accuracy within the temperature range		$\Delta U \leq 0.06$ % / °C			
Transient overvoltage protection		Varistors			
Timing circuit					
Delay time T_V		none	0 or 0.1-30 s adjustable		
Repeat accuracy (constant parameters)		± 0.07 % of full-scale value			
Accuracy within the control supply voltage tolerance		-	$\Delta t \leq 0.5$ %		
Accuracy within the temperature range		-	$\Delta t \leq 0.06$ % / °C		
Indication of operational states					
Control supply voltage	U/T: green LED	 : control supply voltage applied  : tripping delay T_V active			
Measured value	U: red LED	 : overvoltage,  : undervoltage			
Relay status	R: yellow LED	 : relay energized, no latching function  : relay energized, active latching function  : relay de-energized, active latching function			
Output circuits					
Kind of output		1 c/o contact	2 c/o contacts	1x2 c/o contacts or 2x1 c/o contact configurable	
Operating principle		open-circuit principle ¹⁾		open- or closed-circuit principle configurable ¹⁾	
Contact material		AgNi			
Minimum switching voltage / minimum switching current		24 V / 10 mA			
Maximum switching voltage / maximum switching current		250 V AC / 4 A AC			
Rated operational voltage U_o and rated operational current I_o	AC-12 (resistive) at 230 V	4 A			
	AC-15 (inductive) at 230 V	3 A			
	DC-12 (resistive) at 24 V	4 A			
	DC-13 (inductive) at 24 V	2 A			
AC rating (UL 508)	utilization category (Control Circuit Rating Code)	B 300			
	max. rated operational voltage	300 V AC			
	max. continuous thermal current at B 300	5 A			
	max. making/breaking apparent power (make/break) at B 300	3600/360 VA			
Mechanical lifetime		30x10 ⁶ switching cycles			
Electrical lifetime	AC-12, 230 V, 4 A	0.1x10 ⁶ switching cycles			
Max. fuse rating to achieve short-circuit protection	n/c contact	6 A fast-acting	10 A fast-acting	6 A fast-acting	
	n/o contact	10 A fast-acting			

¹⁾ Open-circuit principle: output relay energizes if the measured value exceeds  / falls below  the adjusted threshold value
 Closed-circuit principle: output relay de-energizes if measured value exceeds  / falls below  the adjusted threshold value

Voltage monitoring relays, single-phase

Technical data - Voltage monitoring relays

2

Type	CM-ESS.1	CM-ESS.2	CM-ESS.M	CM-EFS.2
General data				
MTBF	on request			
Duty cycle	100%			
Dimensions	see 'Dimensional drawings'			
Mounting	DIN rail (IEC/EN 60715), snap-on mounting without any tool			
Mounting position	any			
Minimum distance to other units	vertical / horizontal	not necessary / not necessary		
Material of housing	UL 94 V-0			
Degree of protection	housing / terminals	IP50 / IP20		
Environmental data				
Ambient temperature ranges	operation	-20...+60 °C		
	storage	-40...+85 °C		
Damp heat, cyclic (IEC/EN 60068-2-30)	55 °C, 6 cycle			
Vibration, sinusoidal	Class 2			
Shock	Class 2			
Electrical connection				
Wire size		Screw connection technology	Easy Connect Technology (Push-in)	
	fine-strand with(out) wire end ferrule	1 x 0.5-2.5 mm ² (1 x 18-14 AWG) 2 x 0.5-1.5 mm ² (2 x 18-16 AWG)	2 x 0.5-1.5 mm ² (2 x 18-16 AWG)	
	rigid	1 x 0.5-4 mm ² (1 x 20-12 AWG) 2 x 0.5-2.5 mm ² (2 x 20-14 AWG)	2 x 0.5-1.5 mm ² (2 x 20-16 AWG)	
Stripping length	8 mm (0.32 in)			
Tightening torque	0.6-0.8 Nm (7.08 lb.in)		-	
Isolation data				
Rated insulation voltage	input / measuring circuit / output	600 V		
	output 1 / output 2	250 V		
Rated impulse withstand voltage U _{imp}	input / measuring circuit / output	6 kV 1.2/50 µs		
	output 1 / output 2	4 kV 1.2/50 µs		
Pollution degree	3			
Overvoltage category	III			
Standards / Directives				
Standards	IEC/EN 60255-27, IEC/EN 60947-5-1, EN 50178			
Low Voltage Directive	2014/35/EU			
EMC Directive	2014/30/EU			
RoHS Directive	2011/65/EU			
Electromagnetic compatibility				
Interference immunity to electrostatic discharge	IEC/EN 61000-4-2	IEC/EN 61000-6-2 level 3		
radiated, radio-frequency, electromagnetic field	IEC/EN 61000-4-3	level 3		
electrical fast transient / burst surge	IEC/EN 61000-4-4	level 3		
	IEC/EN 61000-4-5	level 3		
conducted disturbances, induced by radio-frequency fields	IEC/EN 61000-4-6	level 3		
Interference emission	IEC/EN 61000-6-3			
high-frequency radiated	IEC/CISPR 22; EN 55022	class B		
high-frequency conducted	IEC/CISPR 22; EN 55022	class B		

Current and voltage monitoring relays, single-phase

Notes

Three-phase monitoring relays

Product group picture

2



Three-phase monitoring relays

Table of contents

Three-phase monitoring relays

Benefits and advantages, Applications	2/27
Operating controls	2/28
Selection table - Singlefunctional	2/29
Ordering details - Singlefunctional	2/30
Selection table - Multifunctional	2/31
Ordering details - Multifunctional	2/32
Function diagrams	2/33
Connection diagrams	2/37
DIP switches, Rotary switches	2/38
Technical data - CM-PBE, CM-PVE, CM-PFE, CM-PFS	2/39
Technical data - CM-PAS, CM-PSS, CM-PVS	2/41
Technical data - CM-PAS, CM-PSS, CM-PVS	2/42
Technical data - CM-MPS	2/43
Technical data - CM-MPS, CM-MPN	2/45

Three-phase monitoring relays

Benefits and advantages, Applications

2

Characteristics of the CM range three-phase monitors ¹⁾

- Suitable for railway applications
- Adjustable phase unbalance threshold value
- Adjustable ON-delay/OFF-delay time
- Dual frequency measuring 50/60 Hz
- Powered by the measuring circuit
- 1 n/o contact, 1 or 2 c/o contacts
- LEDs for the indication of operational states
- Multifunctional and single-functional devices
- Phase failure detection
- Phase sequence monitoring
- Over- and undervoltage monitoring (fixed or adjustable)
- Wide-range operating voltage guarantees world-wide operation
- Various approvals and marks

¹⁾ depending on device type

Phase unbalance monitoring

If the supply by the three-phase system is unbalanced due to uneven distribution of the load, the motor will convert a part of the energy into reactive power. This energy gets lost unexploited; also the motor is exposed to higher thermal stress. Other thermal protection devices fail to detect continuing unbalances which can lead to damage or destruction of the motor. The CM range three-phase monitors with phase unbalance monitoring can reliably detect this critical situation.

Phase sequence

Changing the phase sequence during operation or a wrong phase sequence prior to startup causes a change of the rotational direction of the connected device. Generators, pumps or fans rotate in the wrong direction and the installation is no longer working properly. Especially for moveable equipment, such as construction machinery, phase sequence detection prior to the startup process is highly reasonable.

Phase loss

In case of phase loss, undefined states of the installation are likely to occur. E.g. the startup process of motors is disturbed. All three-phase monitors of the ABB CM range detect a phase loss as soon as the voltage of one phase drops below 60% of its nominal value.

Voltage monitoring

All electric devices can be damaged when operated continuously in a network with out-of-range voltages. For example, safe starting is not ensured in case of undervoltage. Also, the switching state of a contactor is not clearly defined when operated in a „forbidden“ voltage range. This can lead to undefined states of the installation and cause damage or destruction of valuable parts.

Extended functionality

ABB's new generation of three-phase monitoring relays feature additional functions making the application field for the devices considerably larger.

Selectable phase sequence monitoring

The phase sequence monitoring can be switched off by means of a rotary switch or a DIP switch. This enables monitoring of three-phase mains where phase sequence is not relevant for the application, for example in case of motors with forward and reverse rotation, heating applications, etc.

Automatic phase sequence correction

The automatic phase sequence correction is activated by means of a DIP switch. With activated phase sequence correction, it is ensured that for any non-fixed or portable equipment, e.g. construction machinery, the correct phase sequence is always applied to the input terminals of the load. For details regarding the wiring, please see function description / diagrams.

Structure of the type designation

CM-__ x.yz

x: width of enclosure

y: Control supply voltage / measuring range

1	110, 115, 120, 127 V supply systems (phase-neutral)
2	220, 230, 240 V supply systems (phase-neutral)
3	200, 208, 220, 230, 240, 257, 260 V supply systems (phase-phase)
4	440, 460 V supply systems (phase-phase)
5	480, 500 V supply systems (phase-phase)
6	575, 600 V supply systems (phase-phase)
7	660, 690 V supply systems (phase-phase)
8	200, 400 V supply systems (phase-phase)

z: Rated frequency / output circuit

1	50/60 Hz – 1x2 c/o
2	50/60 Hz – 1x2 or 2x1 c/o
3	50/60/400 Hz – 1x2 or 2x1 c/o

Three-phase monitoring relays

Operating controls

S-Range Housing

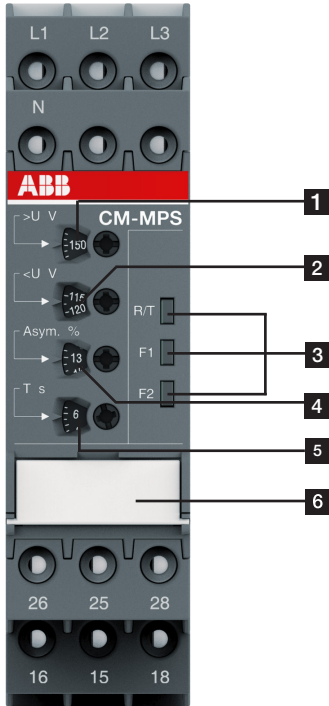

2CDC 253 017 F0013

- 1** Adjustment of the threshold value $>U$ for overvoltage
- 2** Adjustment of the threshold value $<U$ for undervoltage
- 3** Indication of operational states
 - R/T: yellow LED – Relay status / timing
 - F1: red LED – Fault message
 - F2: red LED – Fault message

- 4** Adjustment of the threshold value Asym. for phase unbalance
- 5** Adjustment of the tripping delay T_v
- 6** DIP switches (see DIP switch functions on page 2/40)
 - ON-delay
 - OFF-delay
 - Phase sequence monitoring deactivated
 - Phase sequence monitoring activated
 - Phase sequence correction activated
 - Phase sequence correction deactivated
 - 2x1 c/o (SPDT) contact
 - 1x2 c/o (SPDT) contacts

2

N-Range Housing

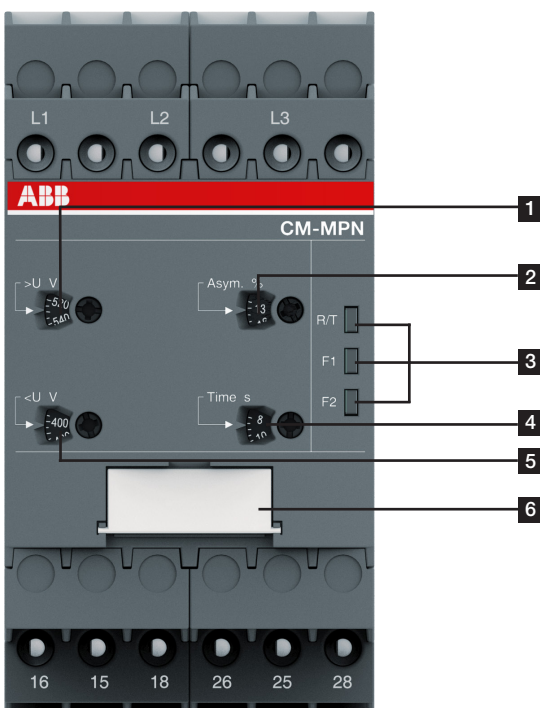

2CDC 253 016 F0013

- 1** Adjustment of the threshold value $>U$ for overvoltage
- 2** Adjustment of the threshold value Asym. for phase unbalance
- 3** Indication of operational states
 - R/T: yellow LED – Relay status / timing
 - F1: red LED – Fault message
 - F2: red LED – Fault message

- 4** Adjustment of the tripping delay T_v
- 5** Adjustment of the threshold value $<U$ for undervoltage
- 6** DIP switches (see DIP switch functions on page 2/40)
 - ON-delay
 - OFF-delay
 - Phase sequence monitoring deactivated
 - Phase sequence monitoring activated
 - Phase sequence correction activated
 - Phase sequence correction deactivated
 - 2x1 c/o (SPDT) contact
 - 1x2 c/o (SPDT) contacts

Three-phase monitoring relays

Selection table - Singlefunctional

	Type	Order number
	CM-PBE	1SVR550881R9400
	CM-PBE	1SVR550882R9500
	CM-PVE	1SVR550870R9400
	CM-PVE	1SVR550871R9500
	CM-PFE	1SVR550824R9100
	CM-PFE.2	1SVR550826R9100
	CM-PFS.S	1SVR730824R9300
	CM-PFS.P	1SVR740824R9300
	CM-PSS.31S	1SVR730784R2300
	CM-PSS.31P	1SVR740784R2300
	CM-PSS.41S	1SVR730784R3300
	CM-PSS.41P	1SVR740784R3300
	CM-PVS.31S	1SVR730794R1300
	CM-PVS.31P	1SVR730794R1300
	CM-PVS.41S	1SVR730794R3300
	CM-PVS.41P	1SVR740794R3300
	CM-PVS.81S	1SVR730794R2300
	CM-PVS.81P	1SVR740794R2300
	CM-PAS.31S	1SVR730774R1300
	CM-PAS.31P	1SVR740774R1300
	CM-PAS.41S	1SVR730774R3300
	CM-PAS.41P	1SVR740774R3300

Rated control supply voltage U _c																				
Phase to phase																				
160-300 V AC																				
200-400 V AC																				
200-500 V AC																				
208-440 V AC																				
300-500 V AC																				
320-460 V AC																				
380 V AC																				
380-440 V AC																				
400 V AC																				
Phase to Neutral																				
185-265 V AC																				
220-240 V AC																				
Rated frequency																				
50/60 Hz																				
Suitable for monitoring																				
Single-phase mains																				
Three-phase mains																				
Monitoring function																				
Phase failure																				
Phase sequence																				
Automatic phase sequence correction																				
Overvoltage																				
Undervoltage																				
Unbalance																				
Neutral ¹⁾																				
Thresholds	fix	fix	fix	fix	fix	fix	fix	fix	fix	fix	fix	fix	fix	fix	adj	adj	adj	adj	adj	adj
Timing functions for tripping delay																				
ON delay																				
On and OFF delay	fix	fix	fix	fix	fix	fix														
Connection type																				
Push-in terminals																				
Double-chamber cage connection terminals																				

¹⁾ The external conductor voltage towards the neutral conductor is measured.

adj: adjustable
 sel: selectable
 fix: fixed

Three-phase monitoring relays

Ordering details - Singlefunctional



2CDC 251 064 V0011

CM-PBE



2CDC 251 064 V0011

CM-PSS.41P



2CDC 251 063 V0011

CM-PAS.31P

Description

The three-phase monitoring relays are designed for use in three-phase mains for monitoring the phase parameters like phase sequence, phase failure, over- and undervoltage as well as phase unbalance.

Ordering details

Characteristics	Type	Order code	Price 1 pc	Weight (1 pc) kg (lb)
See "Selection table - Singlefunctional" on page 2/29.	CM-PBE	1SVR550881R9400		0.08 (0.17)
	CM-PBE	1SVR550882R9500		0.08 (0.17)
	CM-PVE	1SVR550870R9400		0.08 (0.17)
	CM-PVE	1SVR550871R9500		0.08 (0.17)
	CM-PFE	1SVR550824R9100		0.08 (0.17)
	CM-PFE.2	1SVR550826R9100		0.067 (0.147)

Ordering details

Characteristics	Type	Order code	Price 1 pc	Weight (1 pc) kg (lb)
See "Selection table - Singlefunctional" on page 2/29.	CM-PFS.S	1SVR730824R9300		0.127 (0.280)
	CM-PFS.P	1SVR740824R9300		0.119 (0.262)
	CM-PSS.31S	1SVR730784R2300		0.132 (0.291)
	CM-PSS.31P	1SVR740784R2300		0.123 (0.271)
	CM-PSS.41S	1SVR730784R3300		0.132 (0.291)
	CM-PSS.41P	1SVR740784R3300		0.123 (0.271)
	CM-PVS.31S	1SVR730794R1300		0.141 (0.311)
	CM-PVS.31P	1SVR740794R1300		0.132 (0.291)
	CM-PVS.41S	1SVR730794R3300		0.139 (0.306)
	CM-PVS.41P	1SVR740794R3300		0.131 (0.289)
	CM-PVS.81S	1SVR730794R2300		0.136 (0.300)
	CM-PVS.81P	1SVR740794R2300		0.128 (0.282)
	CM-PAS.31S	1SVR730774R1300		0.133 (0.293)
	CM-PAS.31P	1SVR740774R1300		0.124 (0.273)
	CM-PAS.41S	1SVR730774R3300		0.132 (0.291)
	CM-PAS.41P	1SVR740774R3300		0.123 (0.271)

S: screw connection
P: push-in connection



Further documentation three-phase monitoring relays on www.abb.com

Three-phase monitoring relays

Selection table - Multifunctional

2

Type	Order number																	
	CM-MPS.11S	CM-MPS.11P	CM-MPS.21S	CM-MPS.21P	CM-MPS.31S	CM-MPS.31P	CM-MPS.41S	CM-MPS.41P	CM-MPS.23S	CM-MPS.23P	CM-MPS.43S	CM-MPS.43P	CM-MPN.52S	CM-MPN.52P	CM-MPN.62S	CM-MPN.62P	CM-MPN.72S	CM-MPN.72P
	1SVR730885R1300	1SVR740885R1300	1SVR730885R3300	1SVR740885R3300	1SVR730884R1300	1SVR740884R1300	1SVR730884R3300	1SVR740884R3300	1SVR730885R4300	1SVR740885R4300	1SVR730884R4300	1SVR740884R4300	1SVR750487R8300	1SVR760487R8300	1SVR750488R8300	1SVR760488R8300	1SVR750489R8300	1SVR760489R8300
Rated control supply voltage U_s																		
Phase to Phase																		
160-300 V AC					■	■												
300-500 V AC							■	■				■	■					
350-580 V AC													■	■				
450-720 V AC															■	■		
530-820 V AC																	■	■
Phase to Neutral																		
90-170 V AC	■	■																
180-280 V AC			■	■					■	■								
Rated frequency																		
50/60 Hz	■	■	■	■	■	■	■	■					■	■	■	■	■	■
50/60/400 Hz									■	■	■	■						
Suitable for monitoring																		
Single-phase mains	■	■	■	■					■	■								
Three-phase mains	■	■	■	■	■	■	■	■	■	■	■	■	■	■	■	■	■	■
Monitoring function																		
Phase failure	■	■	■	■	■	■	■	■	■	■	■	■	■	■	■	■	■	■
Phase sequence	sel	sel	sel	sel	sel	sel	sel	sel	adj	adj	adj	adj	adj	adj	adj	adj	adj	
Automatic phase sequence correction									adj	adj	adj	adj	adj	adj	adj	adj	adj	
Overvoltage	■	■	■	■	■	■	■	■	■	■	■	■	■	■	■	■	■	■
Undervoltage	■	■	■	■	■	■	■	■	■	■	■	■	■	■	■	■	■	■
Unbalance	■	■	■	■	■	■	■	■	■	■	■	■	■	■	■	■	■	■
Interrupted neutral monitoring ¹⁾	■	■	■	■					■	■								
Thresholds	adj	adj	adj	adj	adj	adj	adj	adj	adj	adj	adj	adj	adj	adj	adj	adj	adj	adj
Timing functions for tripping delay																		
On and OFF delay	adj	adj	adj	adj	adj	adj	adj	adj	adj	adj	adj	adj	adj	adj	adj	adj	adj	adj
Connection type																		
Push-in terminals		■		■		■		■		■		■		■		■		■
Double-chamber cage connection terminals	■		■		■		■		■		■		■		■		■	

1) The external conductor voltage towards the neutral conductor is measured too

adj: adjustable
sel: selectable

Three-phase monitoring relays

Ordering details - Multifunctional

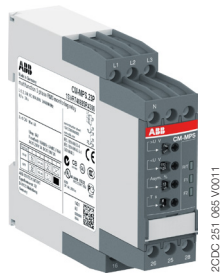

CM-MPS.23P

2CDC 251 065 V0011



CM-MPN.52P

2CDC 251 062 V0011

Ordering details

Characteristics	Type	Order code	Price 1 pc	Weight (1 pc) kg (lb)
	CM-MPS.11S	1SVR730885R1300		0.148 (0.326)
	CM-MPS.11P	1SVR740885R1300		0.137 (0.302)
	CM-MPS.21S	1SVR730885R3300		0.146 (0.322)
	CM-MPS.21P	1SVR740885R3300		0.135 (0.298)
	CM-MPS.31S	1SVR730884R1300		0.142 (0.313)
	CM-MPS.31P	1SVR740884R1300		0.133 (0.293)
	CM-MPS.41S	1SVR730884R3300		0.140 (0.309)
	CM-MPS.41P	1SVR740884R3300		0.132 (0.291)
	CM-MPS.23S	1SVR730885R4300		0.149 (0.328)
	CM-MPS.23P	1SVR740885R4300		0.138 (0.304)
	CM-MPS.43S	1SVR730884R4300		0.148 (0.327)
	CM-MPS.43P	1SVR740884R4300		0.137 (0.302)
	CM-MPN.52S	1SVR750487R8300		0.230 (0.507)
	CM-MPN.52P	1SVR760487R8300		0.226 (0.498)
	CM-MPN.62S	1SVR750488R8300		0.229 (0.505)
	CM-MPN.62P	1SVR760488R8300		0.225 (0.496)
	CM-MPN.72S	1SVR750489R8300		0.224 (0.494)
	CM-MPN.72P	1SVR760489R8300		0.220 (0.485)

See "Selection table - Multifunctional" on page 2/31.

S: screw connection
P: push-in connection



Further documentation three-phase monitoring relays on www.abb.com

Three-phase monitoring relays

Function diagrams

2

Function diagrams - Phase failure detection CM-PBE

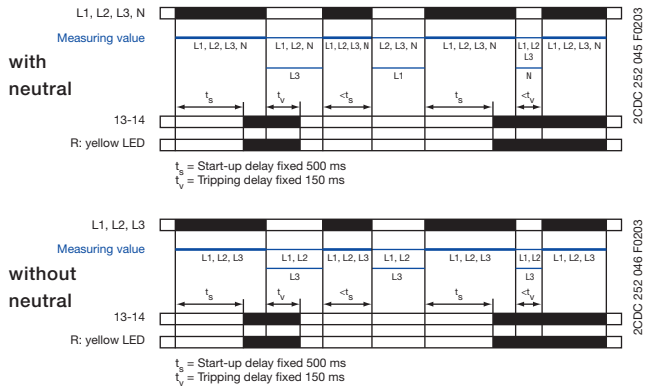

If all phases (and the neutral) are present, the output relay energizes after the start-up delay t_s is complete. If a phase failure occurs, the tripping delay t_v starts. When timing is complete, the output relay de-energizes. As soon as the voltage returns to the tolerance range, timing of t_s starts. When timing is complete, the output relay re-energizes automatically. The yellow LED glows when the output relay is energized.

Function diagrams - Phase failure, under- / overvoltage detection CM-PVE

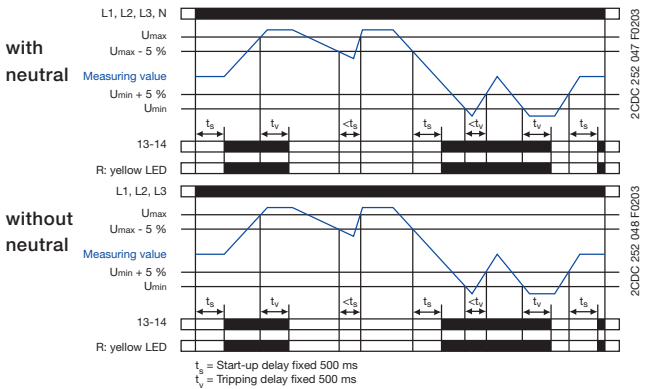

If all phases (and the neutral) are present with correct voltage, the output relay energizes after the start-up delay t_s is complete. If the voltage exceeds or falls below the fixed threshold value or if a phase failure occurs, the tripping delay t_v starts. When timing is complete, the output relay de-energizes. As soon as the voltage returns to the tolerance range, timing of t_s starts. When timing is complete, the output relay re-energizes automatically. The yellow LED glows when the output relay is energized.

Function diagram - Phase failure detection, phase sequence monitoring CM-PFE, CM-PFE.2

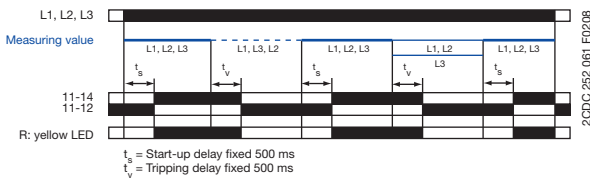

If all phases are present with the correct phase sequence, the output relay energizes after the start-up delay t_s is complete. If a phase failure or a phase sequence error occurs, the tripping delay t_v starts. When timing is complete, the output relay de-energizes. The yellow LED glows when the output relay is energized.

In case of motors which continue running with only two phases, the CM-PFE detects phase failure if the reverse fed voltage is less than 60 % of the originally applied voltage.

Function diagram - Phase failure detection, phase sequence monitoring CM-PFS

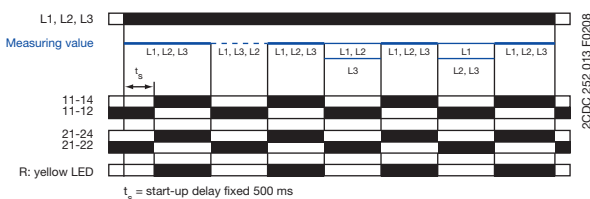

If all phases are present with the correct phase sequence, the output relay energizes after the start-up delay t_s is complete. If a phase failure or a phase sequence error occurs, the output relay de-energizes instantaneous. The yellow LED glows when the output relay is energized.

In case of motors which continue running with only two phases, the CM-PFS detects phase failure if the reverse fed voltage is less than 60 % of the originally applied voltage.

ATTENTION

If several CM-PFS units are placed side by side and the control supply voltage is higher than 415 V, spacing of at least 10 mm has to be kept between the individual units.

Three-phase monitoring relays

Function diagrams

CM-PSS.xx, CM-PVS.xx, CM.PAS.xx, CM-MPS.xx, CM-MPN.xx

Phase sequence monitoring and phase failure detection

Applying control supply voltage begins the fixed start-up delay t_s . When t_s is complete and all phases are present with correct voltage, the output relays energize and the yellow LED R/T glows.

Phase sequence monitoring

If phase sequence monitoring is activated, the output relays de-energize as soon as a phase sequence error occurs. The fault is displayed by alternated flashing of the LEDs F1 and F2. The output relays re-energize automatically as soon as the phase sequence is correct again.

Phase failure detection

The output relays de-energize instantaneous if a phase failure occurs. The fault is indicated by lighting of LED F1 and flashing of LED F2. The output relays re-energize automatically as soon as the voltage returns to the tolerance range.

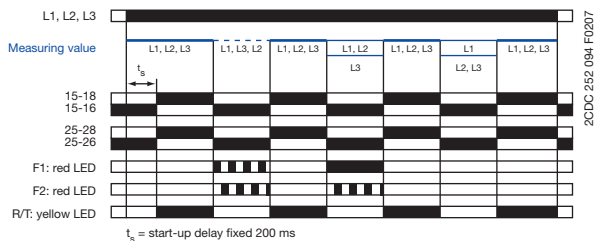

CM-MPS.11, CM-MPS.21, CM-MPS.23

Interrupted neutral monitoring

The interruption of the neutral in the main to be monitored is detected by means of phase unbalance evaluation. Determined by the system, in case of unloaded neutral, i.e. symmetrical load between all three phases, it may happen that an interruption of the neutral will not be detected. If the star point is displaced by asymmetrical load in the three-phase main, an interrupted neutral will be detected.

Displacement of the star point

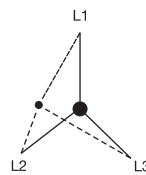

CM-MPS.x3, CM-MPN.x2

Automatic phase sequence correction

This function can be selected only if phase sequence monitoring is activated and operating mode 2x1 c/o (SPDT) contact is selected.

Applying control supply voltage begins the fixed start-up delay t_{s1} . When t_{s1} is complete and all phases are present with correct voltage, output relay R1 energizes. Output relay R2 energizes when the fixed start-up delay t_{s2} is complete and all phases are present with correct phase sequence. Output relay R2 remains de-energized if the phase sequence is incorrect.

If the voltage to be monitored exceeds or falls below the set threshold values for phase unbalance, over- or undervoltage or if a phase failure occurs, output relay R1 de-energizes and the LEDs F1 and F2 indicate the fault.

Output relay R2 is responsive only to a false phase sequence. In conjunction with a reversing contactor combination, this enables an automatic correction of the rotation direction. See circuit diagrams on the right.

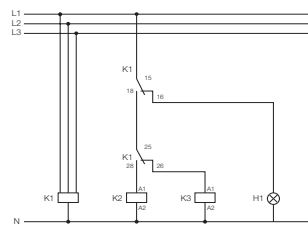
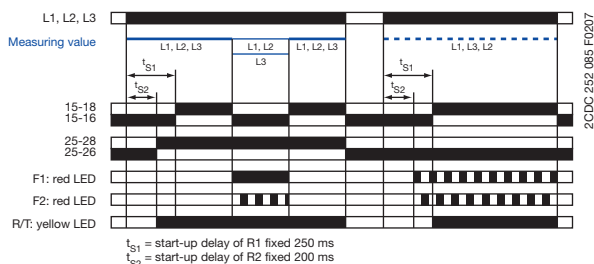

Control circuit diagram
(K1 = CM-MPS.23)

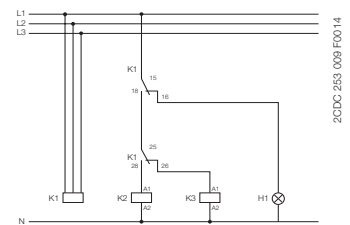

Control circuit diagram
(K1 = CM-MPS.43 or CM-MPN.xx)

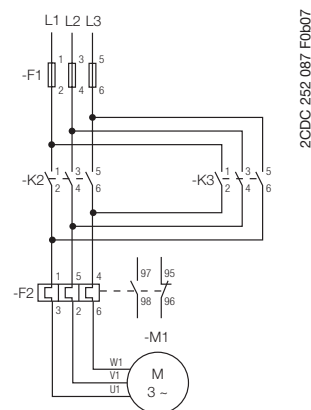

Power circuit diagram

Three-phase monitoring relays

Function diagrams

CM-PSS.xx¹⁾, CM-PVS.xx²⁾, CM-MPS.xx²⁾, CM-MPN.xx²⁾

Over- and undervoltage monitoring 1x2 c/o

Applying control supply voltage begins the fixed start-up delay t_s . When t_s is complete and all phases are present with correct voltage and with correct phase sequence, the output relays energize and the yellow LED R/T glows.

Type of tripping delay = ON-delay

If the voltage to be monitored exceeds or falls below the fixed¹⁾ or set²⁾ threshold value, the output relays de-energize after the set tripping delay t_v is complete. The LED R/T flashes during timing and turns off as soon as the output relays de-energize. The output relays re-energize automatically as soon as the voltage returns to the tolerance range, taking into account a fixed hysteresis of 5 % and the LED R/T glows.

Type of tripping delay = OFF-delay

If the voltage to be monitored exceeds or falls below the fixed¹⁾ or set²⁾ threshold value, the output relays de-energize instantaneously and the LED R/T turns off. As soon as the voltage returns to the tolerance range, taking into account a fixed hysteresis of 5 %, the output relays re-energize automatically after the set tripping delay t_v is complete. The LED R/T flashes during timing and turns steady when timing is complete.

ON-delay 1x2 c/o contacts 1x2 c/o

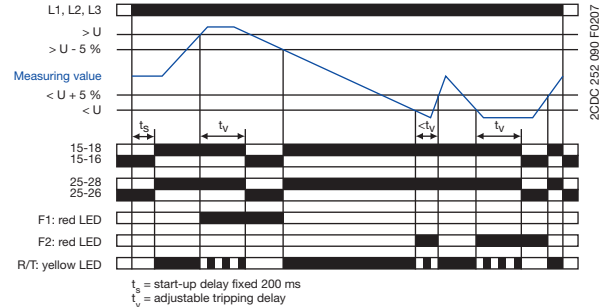

OFF-delay 1x2 c/o contacts 1x2 c/o

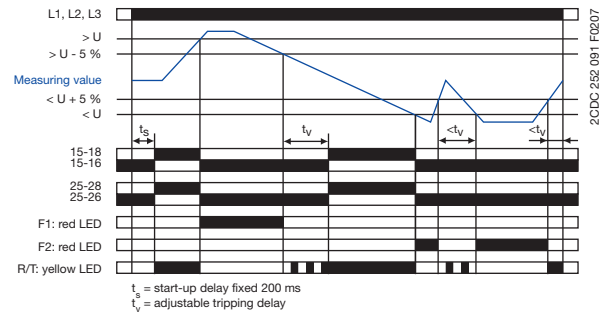

CM-MPS.x3, CM-MPN.x2

Over- and undervoltage monitoring 2x1 c/o

Applying control supply voltage begins the fixed start-up delay t_s . When t_s is complete and all phases are present with correct voltage and with correct phase sequence, the output relays energize. The yellow LED R/T glows as long as at least one output relay is energized.

Type of tripping delay = ON-delay

If the voltage to be monitored exceeds or falls below the set threshold value, output relay R1 (overvoltage) or output relay R2 (undervoltage) de-energizes after the set tripping delay t_v is complete. The LED R/T flashes during timing. The corresponding output relay re-energizes automatically as soon as the voltage returns to the tolerance range, taking into account a fixed hysteresis of 5 %.

Type of tripping delay = OFF-delay

If the voltage to be monitored exceeds or falls below the set threshold value, output relay R1 (overvoltage) or output relay R2 (undervoltage) de-energizes instantaneously. As soon as the voltage returns to the tolerance range, taking into account a fixed hysteresis of 5 %, the corresponding output relay re-energizes automatically after the set tripping delay t_v is complete. The LED R/T flashes during timing.

ON-delay 2x1 c/o contact 2x1 c/o

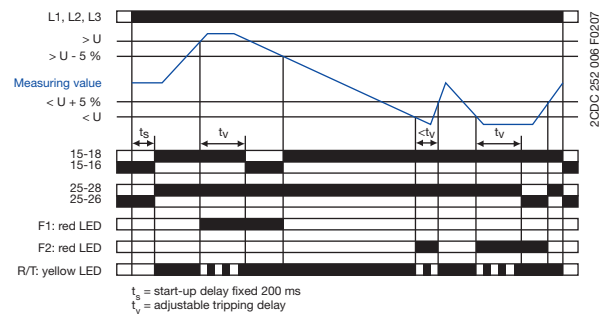

OFF-delay 2x1 c/o contact 2x1 c/o

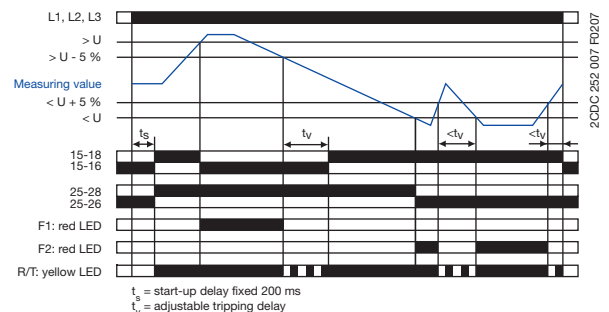

Three-phase monitoring relays

Function diagrams

CM-PAS.xx, CM-MPS.xx, CM-MPN.xx

Phase unbalance monitoring

Applying control supply voltage begins the fixed start-up delay t_s . When t_s is complete and all phases are present with correct voltage and with correct phase sequence, the output relays energize and the yellow LED R/T glows.

Type of tripping delay = ON-delay

If the voltage to be monitored exceeds or falls below the set phase unbalance threshold value, the output relays de-energize after the set tripping delay t_v is complete. The LED R/T flashes during timing and turns off as soon as the output relays de-energize.

The output relays re-energize automatically as soon as the voltage returns to the tolerance range, taking into account a fixed hysteresis of 20 % and the LED R/T glows.

Type of tripping delay = OFF-delay

If the voltage to be monitored exceeds or falls below the set phase unbalance threshold value, the output relays de-energize instantaneously and the LED R/T turns off.

As soon as the voltage returns to the tolerance range, taking into account a fixed hysteresis of 20 %, the output relays re-energize automatically after the set tripping delay t_v is complete. The LED R/T flashes during timing and turns steady when timing is complete.

ON-delay ☒

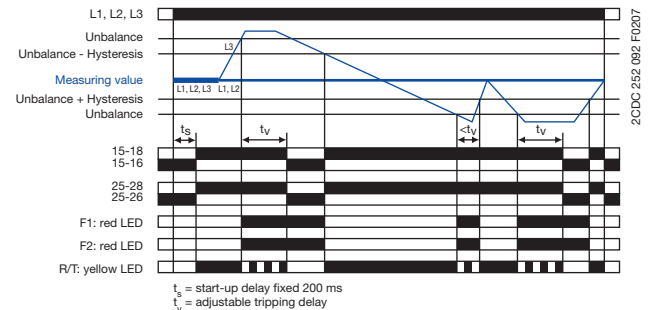

OFF-delay ■

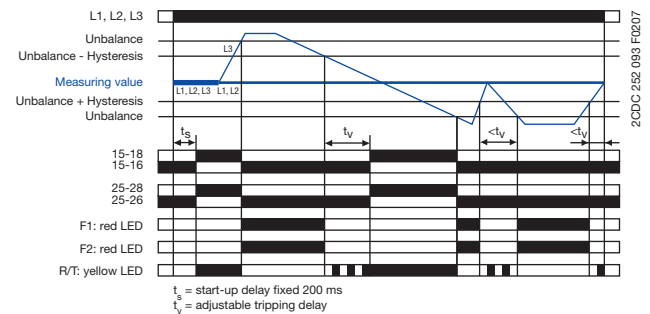

CM-PSS.xx, CM-PSV.xx, CM-PAS.xx, CM-MPS.xx, CM-MPN.xx

LED functions

Function	R/T: yellow LED	F1: red LED	F2: red LED
Control supply voltage applied, output relay energized	[Pulse]	-	-
Tripping delay t_v active	[Pulse]	-	-
Phase failure	-	[Pulse]	[Pulse]
Phase sequence	-	[Alternating]	[Alternating]
Overtvoltage	-	[Pulse]	-
Undervoltage	-	-	[Pulse]
Phase unbalance	-	[Pulse]	[Pulse]
Interruption of the neutral	-	[Pulse]	[Pulse]
Adjustment error ¹⁾	[Pulse]	[Pulse]	[Pulse]

1) Possible misadjustments of the front-face operating controls:
 Overlapping of the threshold values: An overlapping of the threshold values is given, if the threshold value for overvoltage is set to a smaller value than the threshold value for undervoltage.
 DIP switch 3 = OFF and DIP switch 4 = ON: Automatic phase sequence correction is activated and selected operating mode is 1x2 c/o contacts
 DIP switch 2 and 4 = ON: Phase sequence detection is deactivated and the automatic phase sequence correction is activated

Type of tripping delay

The type of tripping delay ☒ / ■ can be adjusted via a rotary (CM-PxS.xx) or a DIP switch (CM-MPx.xx).

Switch position ON-delay ☒:

In case of a fault, the de-energizing of the output relays and the respective fault message are suppressed for the adjusted tripping delay t_v .

Switch position OFF-delay ■:

In case of a fault, the output relays de-energize instantaneously and a fault message is displayed and stored for the length of the adjusted tripping delay t_v . Thereby, also momentary undervoltage conditions are recognized.

Three-phase monitoring relays

Connection diagrams

2

Connection diagrams CM-PBE, CM-PVE

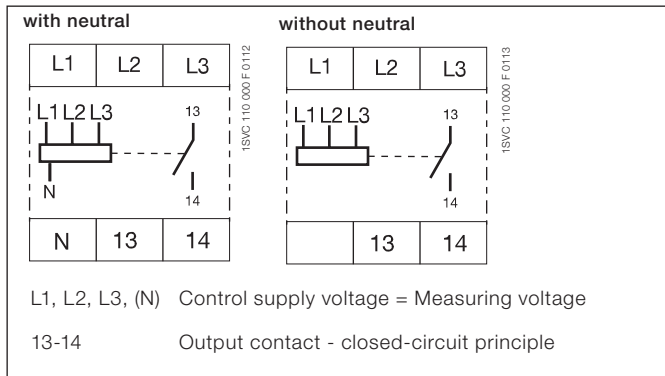

Connection diagram CM-PFE

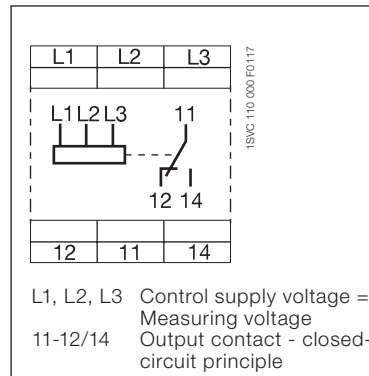

Connection diagram CM-PVS.x1, CM-PSS.x1, CM-PAS.x1

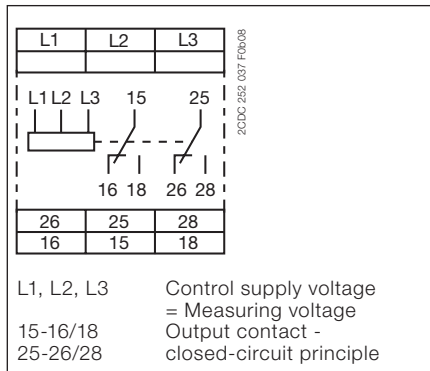

Connection diagram CM-PFS

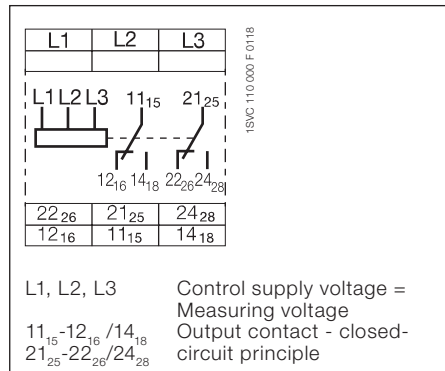

Connection diagram CM-MPS.11, CM-MPS.21, CM-MPS.23

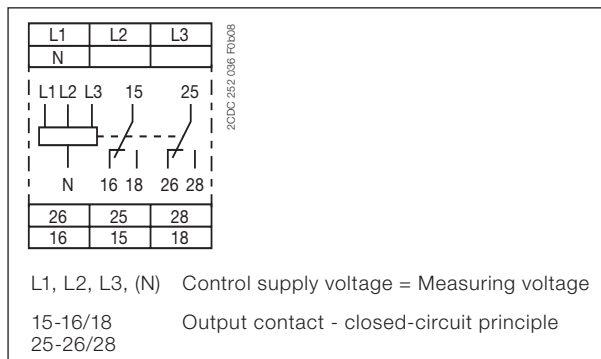

Connection diagram CM-MPS.31, CM-MPS.41, CM-MPS.43

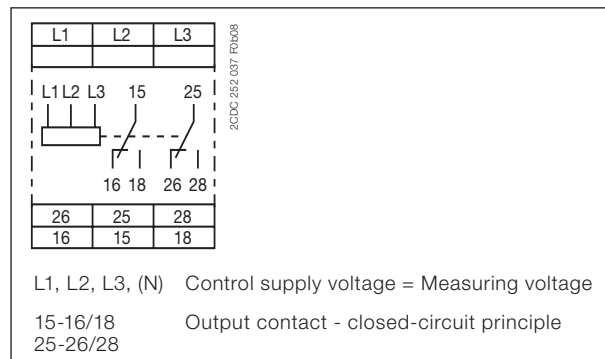



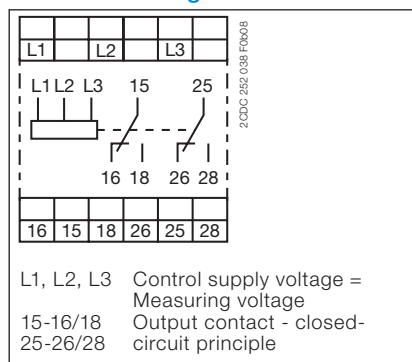

Connection diagram CM-MPN.x2











Three-phase monitoring relays DIP switches, Rotary switches

Rotary switch "Function" CM-PSS, CM-PVS

	ON-delay with phase sequence monitoring
	OFF-delay with phase sequence monitoring
	ON-delay without phase sequence monitoring
	OFF-delay without phase sequence monitoring

DIP switch functions CM-MPS.x3 and CM-MPN.x2

Position	4	3	2	1	2C01C 252 041 FEN06
ON †					
OFF					

1 Timing function
ON ON-delayed
OFF OFF-delayed





2 Phase sequence monitoring
ON deactivated
OFF activated

3 Operating principle of output
ON 2x1 c/o contact
OFF 1x2 c/o contact

4 Phase sequence correction
ON activated
OFF deactivated

Output relay R1 is responsive to overvoltage, output relay R2 is responsive to undervoltage. In case of other faults, both output relays react synchronously.

DIP switch functions CM-MPS.x1

Position	2	1	2C01C 252 040 FEN06
ON †			
OFF			

1 Timing function
ON ON-delayed
OFF OFF-delayed

2 Phase sequence monitoring
ON deactivated
OFF activated

Three-phase monitoring relays

Technical data - CM-PBE, CM-PVE, CM-PFE, CM-PFS

2

Type	CM-PBE ¹⁾	CM-PBE	CM-PVE ¹⁾	CM-PVE	CM-PFE	CM-PFE.2	CM-PFS
Input circuit - Supply circuit	L1-L2-L3-N	L1-L2-L3	L1-L2-L3-N		L1-L2-L3		
Rated control supply voltage U_s = measuring voltage	3x380-440 V AC, 220-240 V AC	3x380-440 V AC	3x320-460 V AC, 185-265 V AC	3x320-460 V AC	3x208-440 V AC	3x200-500 V AC	
Power consumption					13 mA / 9 VA		approx. 15 VA
Rated control supply voltage U_s tolerance	-15...+15 %		-15...+10 %				
Rated frequency	50/60 Hz		50/60 Hz (-10...+10 %)		50/60 Hz		
Input circuit - Measuring circuit	L1-L2-L3-N	L1-L2-L3	L1-L2-L3-N		L1-L2-L3		
Monitoring functions							
phase failure	■	■	■	■	■	■	■
phase sequence	-	-	-	-	■	■	■
over- / undervoltage	-	-	■	■	-	-	-
neutral	■	-	■	-	-	-	-
Measuring ranges	3 x 380-440 V AC, 220-240 V AC	3 x 380-440 V AC	3 x 320-460 V AC, 185-265 V AC	3 x 320-460 V AC	3 x 208-440 V AC	3 x 200-500 V AC	
Thresholds	U_{min}	0.6 x U_N	fixed 185 V / 320 V	fixed 320 V	0.6 x U_N		
	U_{max}	-	fixed 265 V / 460 V	fixed 460 V	-		
Hysteresis related to the threshold value		fixed 5 % (release value = 0.65 x U_N)	fixed 5 %		-		
Response time		40 ms	80 ms		500 ms		
Accuracy within the temperature range		-	$\Delta U \leq 0.06 \% / ^\circ C$		-		
Timing circuit							
Start-up delay t_s		fixed 500 ms ($\pm 20\%$)			fixed 500 ms		
Tripping t_v		fixed 150 ms ($\pm 20\%$)	at over- / undervoltage fixed 500 ms ($\pm 20\%$)		fixed 500 ms		-
Indication of operational states							
Relay status	R: yellow LED	┌───┐ output relay energized					
Fault message	F: red LED	only CM-PFS: ┌───┐ phase failure / ┌──┐ phase sequence error					
Output circuits		13-14			11-12/14		11₁₅-12₁₆ / 14₁₈[*] 21₂₅-22₂₆ / 24₂₈
Kind of output		1 n/o contact			1 c/o contact		2 c/o contacts
Operating principle		closed-circuit principle ²⁾					
Min. switching voltage / Min. switching current		24 V / 10 mA					
Max. switching voltage / Max. switching current		see data sheets					
Rated operational voltage U_s and rated operational current I_s		AC-12 (resistive) 230 V	4 A				
		AC-15 (inductive) 230 V	3 A				
		DC-12 (resistive) 24 V	4 A				
		DC-13 (inductive) 24 V	2 A				
AC rating (UL 508)	utilization category (Control Circuit Rating Code)	B300 pilot duty; general purpose 250 V, 4 A, cos phi 0.75					
	max. rated operational voltage	300 V AC					
	max. continuous thermal current at B 300	5 A					
	max. making/breaking apparent power at B 300	3600/360 VA					
Mechanical lifetime		30 x 10 ⁶ switching cycles					
Electrical lifetime (AC-12, 230 V, 4 A)		0.1 x 10 ⁶ switching cycles					
Max. fuse rating to achieve short-circuit protection	n/c contact	10 A fast-acting			6 A fast-acting		
	n/o contact	10 A fast-acting					
Conventional thermal current I_{th}		4 A					

¹⁾ Device with neutral monitoring: The external conductor voltage towards the neutral conductor is measured.

²⁾ Closed-circuit principle: Output relay is de-energized if the measured value exceeds/drops below the adjusted threshold.

Three-phase monitoring relays

Technical data - CM-PBE, CM-PVE, CM-PFE, CM-PFS

2

Type	CM-PBE ¹⁾	CM-PBE	CM-PVE ¹⁾	CM-PVE	CM-PFE	CM-PFE.2	CM-PFS
General data							
Duty cycle	100 %						
Dimensions	see 'Dimensional drawings'						
Mounting	DIN rail (IEC/EN 60715)						
Mounting position	any						
Minimum distance to other units	horizontal	not necessary			≥ 10 mm if ambient temperature > 50 °C and rated operational currents > 2 A		≥ 10 mm in case of continuous measuring voltage > 440 V
Degree of protection	housing / terminals	IP50 / IP20					
Electrical connection							
Connecting capacity	fine-strand with wire end ferrule	2 x 0.75-1.5 mm ² (2 x 18-16 AWG)					same as CM-PSS.31
	fine-strand without wire end ferrule	2 x 1-1.5 mm ² (2 x 18-16 AWG)					
Stripping length	rigid	2 x 0.75-1.5 mm ² (2 x 18-16 AWG)					same as CM-PSS.31
		10 mm (0.39 in)					
Tightening torque	0.6-0.8 Nm						
Environmental data							
Ambient temperature range	operation / storage	-20...+60 °C / -40...+85 °C					
Climatic class						3K3	
Damp heat	IEC/EN 60068-2-30	40 °C, 93 % RH, 4 days				-	
Damp heat, cyclic	IEC/EN 60068-2-30					6 x 24 h cycle, 55 °C, 95 % RH	
Vibration withstand	IEC/EN 60068-2-6	10-57 Hz: 0.075 mm; 57-150 Hz: 1 g				-	
Vibration, sinusoidal		-				class 2	
Shock		-				class 2	
Isolation data							
Rated insulation voltage U _i	between input, measuring and output circuits	400 V				-	
	input circuit / output circuit	-				600 V	
	output circuit 1 / output circuit 2	-				300 V	
Rated impulse withstand voltage U _{imp}	between input, measuring and output circuits	4 kV / 1.2 - 50 μs				-	
	input circuit / output circuit	-				6 kV	
	output circuit 1 / output circuit 2	-				4 kV	
Basic insulation	input circuit / output circuit	-				600 V AC	
Pollution degree		3					
Overvoltage category		III					
Standards / Directives							
Standards		IEC/EN 60947-5-1, EN 50178			IEC/EN 60255-27, IEC/EN 60947-5-1, EN 50178		
Low Voltage Directive		2014/35/EU					
EMC Directive		2014/30/EU					
RoHS Directive		2011/65/EU					
Electromagnetic compatibility							
Interference immunity to electrostatic discharge	IEC/EN 61000-4-2	level 3 - 6 kV / 8 kV					level 3 - 10 V/m (1 GHz) 3 V/m (2 GHz) 1 V/m (2.7 GHz)
radiated, radio-frequency, electromagnetic field	IEC/EN 61000-4-3	level 3 - 10 V/m					
electrical fast transient / burst	IEC/EN 61000-4-4	level 3 - 2 kV / 5 kHz					
surge	IEC/EN 61000-4-5	level 4 - 2 kV L-L					
conducted disturbances, induced by radio-frequency fields	IEC/EN 61000-4-6	level 3 - 10 V					
voltage dips, short interruptions and voltage variations	IEC/EN 61000-4-11	-					class 3
harmonics and interharmonics	IEC/EN 61000-4-13	-					class 3
Interference emission							
high-frequency radiated	IEC/CISPR 22, EN 55022	class B					
high-frequency conducted	IEC/CISPR 22, EN 55022	class B					

¹⁾ Device with neutral monitoring: The external conductor voltage towards the neutral conductor is measured.

Three-phase monitoring relays

Technical data - CM-PAS, CM-PSS, CM-PVS

2

Type	CM-PSS.31	CM-PSS.41	CM-PVS.31	CM-PVS.41	CM-PVS.81	CM-PAS.31	CM-PAS.41	
Input circuit = Measuring circuit				L1, L2, L3				
Rated control supply voltage U_s = measuring voltage	3x380 V AC	3x400 V AC	3x160-300 V AC	3x300-500 V AC	3x200-400 V AC	3x160-300 V AC	3x300-500 V AC	
Rated control supply voltage U_s tolerance	-15...+10 %							
Rated frequency	50/60 Hz							
Frequency range	45-65 Hz							
Typical current / power consumption	25 mA / 18 VA (380 V AC)	25 mA / 18 VA (400 V AC)	25 mA / 10 VA (230 V AC)	25 mA / 18 VA (400 V AC)	19 mA / 10 VA (300 V AC)	25 mA / 10 VA (230 V AC)	25 mA / 18 VA (400 V AC)	
Measuring circuit				L1, L2, L3				
Monitoring functions	phase failure	■	■	■	■	■	■	
	phase sequence	can be switched off					■	■
	automatic phase sequence correction	-	-	-	-	-	-	
	over- / undervoltage	■	■	■	■	■	-	
	phase unbalance	-	-	-	-	-	■	
	neutral	-	-	-	-	-	-	
Measuring range	overvoltage	3x418 V AC	3x440 V AC	3x220-300 V AC	3x420-500 V AC	3x300-400 V AC	-	
	undervoltage	3x342 V AC	3x360 V AC	3x160-230 V AC	3x300-380 V AC	3x210-300 V AC	-	
	phase unbalance	-	-	-	-	-	2-25 % of average of phase voltages	
Thresholds	overvoltage	fixed	-	-	adjustable within measuring range	-	-	
	undervoltage	fixed	-	-	adjustable within measuring range	-	-	
	phase unbalance (switch-off value)	-	-	-	-	-	adjust. within meas. range	
Tolerance of the adjusted threshold value	6 % of full-scale value							
Hysteresis related to the threshold value	over- / undervoltage	fixed 5 %	-	-	-	-	-	
	phase unbalance	-	-	-	-	-	fixed 20 %	
Maximum measuring cycle time	100 ms							
Accuracy within the temperature range	$\Delta U \leq 0.06 \% / ^\circ\text{C}$							
Measuring method	true RMS							
Timing circuit								
Start-up delay t_s	fixed 200 ms							
Tripping delay t_v	ON- or OFF-delay 0; 0.1-30 s adjustable					ON- delay 0; 0.1-30 s adjustable		
Repeat accuracy (constant parameters)	-	-	-	-	< $\pm 0.2 \%$	-	-	
Accuracy within the rated control supply voltage tolerance	$\Delta t \leq 0.5 \%$							
Accuracy within the temperature range	$\Delta t \leq 0.06 \% / ^\circ\text{C}$							
Indication of operational states								
	details see function description / -diagrams		1 yellow LED, 2 red LEDs details see operating mode and function description / -diagrams			details see function description / -diagrams		
Output circuits								
15-16/18, 25-26/28								
Kind of output	relay, 2 x 1 c/o contact							
Operating principle	closed-circuit principle ¹⁾							
Contact material	AgNi alloy, Cd free							
Minimum switching power	24 V / 10 mA							
Maximum switching voltage	see "Load limit curves" on page 2/105							

¹⁾ Closed-circuit principle: Output relay(s) de-energize(s) if measured value exceeds or falls below the adjusted threshold value

Three-phase monitoring relays

Technical data - CM-PAS, CM-PSS, CM-PVS

Type		CM-PSS.31	CM-PSS.41	CM-PVS.31	CM-PVS.41	CM-PVS.81	CM-PAS.31	CM-PAS.41
Rated operational voltage U _e and rated operational current I _e	AC-12 (resistive) 230 V	4 A						
	AC-15 (inductive) 230 V	3 A						
	DC-12 (resistive) 24 V	4 A						
	DC-13 (inductive) 24 V	2 A						
AC rating (UL 508) utilization category (Control Circuit Rating Code)		B 300						
	max. rated operational voltage	300 V AC						
	max. continuous thermal current at B 300	5 A						
	max. making/breaking apparent power at B 300	3600/360 VA						
Mechanical lifetime		30 x 10 ⁶ switching cycles						
Electrical lifetime (AC-12, 230 V, 4 A)		0.1 x 10 ⁶ switching cycles						
Max. fuse rating to achieve short-circuit protection	n/c contact	6 A fast-acting						
	n/o contact	10 A fast-acting						
General data								
MTBF		on request						
Duty cycle		100%						
Dimensions		see "Dimensional drawings"						
Mounting		DIN rail (IEC/EN 60715), snap-on mounting without any tool						
Mounting position		any						
Minimum distance to other units	horizontal	10 mm (0.39 in) in case of continuous measuring voltages						
		> 400 V	> 400 V	> 220 V	> 400 V	-	> 220 V	> 400 V
Material of housing		UL 94 V-0						
Degree of protection	housing / terminals	IP50 / IP20						
Electrical connection								
Connecting capacity		Screw connection technology			Easy Connect Technology (Push-in)			
	fine-strand with(out) wire end ferrule	1 x 0.5-2.5 mm ² (1 x 18-14 AWG)			2 x 0.5-1.5 mm ² (2 x 18-16 AWG)			
	rigid	2 x 0.5-1.5 mm ² (2 x 18-16 AWG)			2 x 0.5-1.5 mm ² (2 x 20-16 AWG)			
		1 x 0.5-4 mm ² (1 x 20-12 AWG)			2 x 0.5-2.5 mm ² (2 x 20-14 AWG)			
Stripping length		8 mm (0.32 in)						
Tightening torque		0.6-0.8 Nm (7.08 lb.in)						
Environmental data								
Ambient temperature ranges	operation / storage	-25...+60 °C / -40...+85 °C						
Damp heat, cyclic (IEC/EN 60068-2-30)		6 x 24 h cycle, 55 °C, 95 % RH						
Climatic class		3K3						
Vibration, sinusoidal		class 2						
Shock		class 2						
Isolation data								
Rated insulation voltage U	input circuit / output circuit	600 V						
	output circuit 1 / output circuit 2	300 V						
Rated impulse withstand voltage U _{imp}	input circuit / output circuit	6 kV; 1.2/50 μs						
	output circuit 1 / output circuit 2	4 kV; 1.2/50 μs						
Basic insulation	input circuit / output circuit	600 V						
Protective separation (IEC/EN 61140, EN 50178)	input circuit / output circuit	-						
Pollution degree		3						
Overvoltage category		III						
Standards / Directives								
Standards		IEC/EN 60255-27, IEC/EN 60947-5-1, EN 50178						
Low Voltage Directive		2014/35/EU						
EMC directive		2014/30/EU						
RoHS directive		2011/65/EU						
Electromagnetic compatibility								
Interference immunity to		IEC/EN 61000-6-2						
electrostatic discharge	IEC/EN 61000-4-2	level 3 (6 kV / 8 kV)						
radiated, radio-frequency, electromagnetic field	IEC/EN 61000-4-3	level 3 (10 V/m)						
electrical fast transient / burst	IEC/EN 61000-4-4	level 3 (2 kV / 2 kHz)						
surge	IEC/EN 61000-4-5	level 4 (2 kV L-L)						
conducted disturbances, induced by radio-frequency fields	IEC/EN 61000-4-6	level 3 (10 V)						
Interference emission		IEC/EN 61000-6-3						
high-frequency radiated	IEC/CISPR 22, EN 55022	class B						
high-frequency conducted	IEC/CISPR 22, EN 55022	class B						

Three-phase monitoring relays

Technical data - CM-MPS

2

Type		CM-MPS.11	CM-MPS.21	CM-MPS.31	CM-MPS.41
Input circuit = Measuring circuit		L1, L2, L3, N		L1, L2, L3	
Rated control supply voltage U_s = measuring voltage		3x90-170 V AC	3x180-280 V AC	3x160-300 V AC	3x300-500 V AC
Rated control supply voltage U_s tolerance		-15...+10 %			
Rated frequency		50/60 Hz			
Frequency range		45-65 Hz			
Typical current / power consumption		25 mA / 10 VA (115 V AC)	25 mA / 18 VA (230 V AC)	25 mA / 10 VA (230 V AC)	25 mA / 18 VA (400 V AC)
Measuring circuit		L1, L2, L3, N		L1, L2, L3	
Monitoring functions	phase failure	■	■	■	■
	phase sequence	can be switched off			
	automatic phase sequence correction	-			
	over- / undervoltage	■	■	■	■
	phase unbalance	■	■	■	■
	interrupted neutral	■	■	-	-
Measuring range	overvoltage	3x120-170 V AC	3x240-280 V AC	3x220-300 V AC	3x420-500 V AC
	undervoltage	3x90-130 V AC	3x180-220 V AC	3x160-230 V AC	3x300-380 V AC
	phase unbalance	2-25 % of average of phase voltages			
Thresholds	overvoltage	adjustable within measuring range			
	undervoltage	adjustable within measuring range			
	phase unbalance (switch-off value)	adjustable within measuring range			
Tolerance of the adjusted threshold value		6 % of full-scale value			
Hysteresis related to the threshold value	over- / undervoltage	fixed 5 %			
	phase unbalance	fixed 20 %			
Maximum measuring cycle time		100 ms			
Accuracy within the temperature range		$\Delta U \leq 0.06 \% / ^\circ\text{C}$			
Measuring method		true RMS			
Timing circuit					
Start-up delay t_s		fixed 200 ms			
Tripping delay t_v		ON- or OFF-delay 0; 0.1-30 s adjustable			
Accuracy within the rated control supply voltage tolerance		$\Delta t \leq 0.5 \%$			
Accuracy within the temperature range		$\Delta t \leq 0.06 \% / ^\circ\text{C}$			
Indication of operational states		details see function description / -diagrams			
Output circuits		15-16/18, 25-26/28			
Kind of output		relay, 1 x 2 c/o contacts			
Operating principle		closed-circuit principle ¹⁾			
Contact material		AgNi alloy, Cd free			
Minimum switching power		24 V / 10 mA			
Maximum switching voltage		see "Load limit curves" on page 2/105			
Rated operational voltage U_o and rated operational current I_o	AC-12 (resistive) 230 V	4 A			
	AC-15 (inductive) 230 V	3 A			
	DC-12 (resistive) 24 V	4 A			
	DC-13 (inductive) 24 V	2 A			
AC rating (UL 508)	utilization category (Control Circuit Rating Code)	B 300			
	max. rated operational voltage	300 V AC			
	max. continuous thermal current at B 300	5 A			
	max. making/breaking apparent power at B 300	3600/360 VA			
Mechanical lifetime		30 x 10 ⁶ switching cycles			
Electrical lifetime (AC-12, 230 V, 4 A)		0.1 x 10 ⁶ switching cycles			
Max. fuse rating to achieve short-circuit protection	n/c contact	6 A fast-acting			
	n/o contact	10 A fast-acting			

¹⁾ Closed-circuit principle: Output relay(s) de-energize(s) if measured value exceeds or falls below the adjusted threshold value

Three-phase monitoring relays

Technical data - CM-MPS

2

Type	CM-MPS.11	CM-MPS.21	CM-MPS.31	CM-MPS.41
General data				
MTBF	on request			
Duty cycle	100%			
Dimensions	see 'Dimensional drawings'			
Mounting	DIN rail (IEC/EN 60715), snap-on mounting without any tool			
Mounting position	any			
Minimum distance to other units	horizontal	10 mm (0.39 in) in case of continuous measuring voltages		
		> 120 V	> 240 V	> 220 V
				> 400 V
Material of housing	UL 94 V-0			
Degree of protection	housing / terminals	IP50 / IP20		
Electrical connection				
Connecting capacity		Screw connection technology	Easy Connect Technology (Push-in)	
	fine-strand with(out) wire end ferrule	1 x 0.5-2.5 mm ² (1 x 18-14 AWG) 2 x 0.5-1.5 mm ² (2 x 18-16 AWG)	2 x 0.5-1.5 mm ² (2 x 18-16 AWG)	
	rigid	1 x 0.5-4 mm ² (1 x 20-12 AWG) 2 x 0.5-2.5 mm ² (2 x 20-14 AWG)	2 x 0.5-1.5 mm ² (2 x 20-16 AWG)	
Stripping length		8 mm (0.32 in)		
Tightening torque		0.6-0.8 Nm (7.08 lb.in)		
			-	
Environmental data				
Ambient temperature ranges	operation / storage	-25...+60 °C / -40...+85 °C		
Damp heat, cyclic (IEC/EN 60068-2-30)		6 x 24 h cycle, 55 °C, 95 % RH		
Climatic class		3K3		
Vibration		class 2		
Shock		class 2		
Isolation data				
Rated insulation voltage U _i	input circuit / output circuit	600 V		
	output circuit 1 / output circuit 2	300 V		
Rated impulse with-stand voltage U _{imp}	input circuit / output circuit	6 kV; 1.2/50 μs		
	output circuit 1 / output circuit 2	4 kV; 1.2/50 μs		
Basic insulation	input circuit / output circuit	600 V		
Protective separation (IEC/EN 61140, EN 50178)	input circuit / output circuit	yes	-	
Pollution degree		3		
Overvoltage category		III		
Standards / Directives				
Standards		IEC/EN 60255-27, IEC/EN 60947-5-1 EN 50178		
Low Voltage Directive		2014/35/EU		
EMC directive		2014/30/EU		
RoHS directive		2011/65/EU		
Electromagnetic compatibility				
Interference immunity to		IEC/EN 61000-6-2		
electrostatic discharge	IEC/EN 61000-4-2	level 3 (6 kV / 8 kV)		
radiated, radio-frequency, electromagnetic field	IEC/EN 61000-4-3	level 3 (10 V/m)		
electrical fast transient / burst	IEC/EN 61000-4-4	level 3 (2 kV / 2 kHz)		
surge	IEC/EN 61000-4-5	level 4 (2 kV L-N)	level 4 (2 kV L-L)	
conducted disturbances, induced by radio-frequency fields	IEC/EN 61000-4-6	level 3 (10 V)		
harmonics and interharmonics	IEC/EN 61000-4-13	class 3		
Interference emission		IEC/EN 61000-6-3		
high-frequency radiated	IEC/CISPR 22, EN 55022	class B		
high-frequency conducted	IEC/CISPR 22, EN 55022	class B		

Three-phase monitoring relays

Technical data - CM-MPS, CM-MPN

2

Type	CM-MPS.23	CM-MPS.43	CM-MPN.52	CM-MPN.62	CM-MPN.72
Input circuit = Measuring circuit	L1, L2, L3, N	L1, L2, L3			
Rated control supply voltage U_s = measuring voltage	3x180-280 V AC	3x300-500 V AC	3x350-580 V AC	3x450-720 V AC	3x530-820 V AC
Rated control supply voltage U_s tolerance	-15...+10 %				
Rated frequency	50/60/400 Hz		50/60 Hz		
Frequency range	45-440 Hz		45-65 Hz		
Typical current / power consumption	5 mA / 4 VA (230 V AC)	5 mA / 4 VA (400 V AC)	29 mA / 41 VA (480 V AC)	29 mA / 52 VA (600 V AC)	29 mA / 59 VA (690 V AC)
Measuring circuit	L1, L2, L3, N	L1, L2, L3			
Monitoring functions	phase failure	■	■	■	■
	phase sequence	can be switched off			
	automatic phase sequence correction	configurable			
	over- / undervoltage	■	■	■	■
	phase unbalance	■	■	■	■
	interrupted neutral	■	■	■	■
Measuring range	overvoltage	3x240-280 V AC	3x420-500 V AC	3x480-580 V AC	3x600-720 V AC
	undervoltage	3x180-220 V AC	3x300-380 V AC	3x350-460 V AC	3x450-570 V AC
	phase unbalance	2-25 % of average of phase voltages			
Thresholds	overvoltage	adjustable within measuring range			
	undervoltage	adjustable within measuring range			
	phase unbalance (switch-off value)	adjustable within measuring range			
Tolerance of the adjusted threshold value		6 % of full-scale value			
Hysteresis related to the threshold value	over- / undervoltage	fixed 5 %			
	phase unbalance	fixed 20 %			
Maximum measuring cycle time		100 ms			
Accuracy within the temperature range		$\Delta U \leq 0.06 \% / ^\circ C$			
Measuring method		true RMS			
Timing circuit					
Start-up delay t_{s1} and t_{s2}		fixed 200 ms			
Start-up delay t_{s1}		fixed 250 ms			
Tripping delay t_v		ON- or OFF-delay 0; 0.1-30 s adjustable			
Accuracy within the rated control supply voltage tolerance		$\Delta t \leq 0.5 \%$			
Accuracy within the temperature range		$\Delta t \leq 0.06 \% / ^\circ C$			
Indication of operational states		Details see function description / -diagrams			
Output circuits		15-16/18, 25-26/28			
Kind of output		relay, 2 x 1 or 1 x 2 c/o contacts configurable			
Operating principle		closed-circuit principle ¹⁾			
Contact material		AgNi alloy, Cd free			
Minimum switching power		24 V / 10 mA			
Maximum switching voltage		see "Load limit curves" on page 2/105			
Rated operational voltage U_e and rated operational current I_e	AC-12 (resistive) 230 V	4 A			
	AC-15 (inductive) 230 V	3 A			
	DC-12 (resistive) 24 V	4 A			
	DC-13 (inductive) 24 V	2 A			
AC rating (UL 508)	utilization category (Control Circuit Rating Code)	B 300			
	max. rated operational voltage	300 V AC			
	max. continuous thermal current at B 300	5 A			
	max. making/breaking apparent power at B 300	3600/360 VA			
Mechanical lifetime		30 x 10 ⁶ switching cycles			
Electrical lifetime (AC-12, 230 V, 4 A)		0,1 x 10 ⁶ switching cycles			
Max. fuse rating to achieve short-circuit protection	n/c contact	6 A fast-acting		10 A fast-acting	
	n/o contact	10 A fast-acting			

¹⁾ Closed-circuit principle: Output relay(s) de-energize(s) if measured value exceeds or falls below the adjusted threshold value

Three-phase monitoring relays

Technical data - CM-MPS, CM-MPN

2

Type	CM-MPS.23	CM-MPS.43	CM-MPN.52	CM-MPN.62	CM-MPN.72
General data					
MTBF	on request				
Duty cycle	100%				
Dimensions	see 'Dimensional drawings'				
Mounting	DIN rail (IEC/EN 60715), snap-on mounting without any tool				
Mounting position	any				
Minimum distance to other units	horizontal	10 mm (0.39 in)	not necessary		
Material of housing	UL 94 V-0				
Degree of protection	housing / terminals	IP50 / IP20			
Electrical connection					
Connecting capacity	fine-strand with(out) wire end ferrule	Screw connection technology		Easy Connect Technology (Push-in)	
		1 x 0.5-2.5 mm ² (1 x 18-14 AWG)	2 x 0.5-1.5 mm ² (2 x 18-16 AWG)	2 x 0.5-1.5 mm ² (2 x 18-16 AWG)	
Stripping length	rigid	1 x 0.5-4 mm ² (1 x 20-12 AWG)	2 x 0.5-1.5 mm ² (2 x 20-16 AWG)		
		2 x 0.5-2.5 mm ² (2 x 20-14 AWG)	8 mm (0.32 in)		
Tightening torque	0.6-0.8 Nm (7.08 lb.in)			-	
Environmental data					
Ambient temperature ranges	operation / storage	-25...+60 °C / -40...+85 °C			
Damp heat, cyclic (IEC/EN 60068-2-30)	6 x 24 h cycle, 55 °C, 95 % RH				
Climatic class	3K3				
Vibration, sinusoidal	class 2				
Shock	class 2				
Isolation data					
Rated insulation voltage U _i	input circuit / output circuit	600 V		1000 V	
	output circuit 1 / output circuit 2	300 V			
Rated impulse withstand voltage U _{imp}	input circuit / output circuit	6 kV; 1.2/50 μs		8 kV; 1.2/50 μs	
	output circuit 1 / output circuit 2	4 kV; 1.2/50 μs			
Basic insulation	input circuit / output circuit	600 V		1000 V	
Protective separation (IEC/EN 61140, EN 50178)	input circuit / output circuit	-			
Pollution degree	3				
Overvoltage category	III				
Standards / Directives					
Standards	IEC/EN 60255-27, IEC/EN 60947-5-1 EN 50178				
Low Voltage Directive	2014/35/EU				
EMC directive	2014/30/EU				
RoHS directive	2011/65/EU				
Electromagnetic compatibility					
Interference immunity to	IEC/EN 61000-6-2				
electrostatic discharge	IEC/EN 61000-4-2	level 3 (6 kV / 8 kV)			
radiated, radio-frequency, electromagnetic field	IEC/EN 61000-4-3	level 3 (10 V/m)			
electrical fast transient / burst	IEC/EN 61000-4-4	level 3 (2 kV / 2 kHz)			
surge	IEC/EN 61000-4-5	level 4 (2 kV L-N)	level 4 (2 kV L-L)		
conducted disturbances, induced by radio-frequency fields	IEC/EN 61000-4-6	level 3 (10 V)			
harmonics and interharmonics	IEC/EN 61000-4-13	class 3			
Interference emission	IEC/EN 61000-6-3				
high-frequency radiated	IEC/CISPR 22, EN 55022	class B			
high-frequency conducted	IEC/CISPR 22, EN 55022	class B			

Grid feeding monitoring relays - Voltage and frequency monitoring functions Product group picture

2



Grid feeding monitoring relays - Voltage and frequency monitoring functions Table of contents

Grid feeding monitoring relays - Voltage and frequency monitoring functions

Benefits and advantages, operating controls	2/49
Selection table - Ordering details	2/50

Grid feeding monitoring relays - Voltage and frequency monitoring functions Benefits and advantages, operating controls

Description

2

The grid feeding monitoring relays CM-UFD.M* are designed to monitor the voltage and the frequency of the public low voltage or medium voltage grid. Whenever the measured values are not within the range of the adjusted threshold values, the CM-UFD.M* causes tripping of the section switch (consisting of 1 or 2 switching devices according to the applicable standard). This tripping disconnects the power generation such as photovoltaic systems, wind turbines, block-type thermal power stations from the grid.

Optionally, devices with Modbus RTU enable control commands to the grid feeding monitoring relay and provide status information as well as actual process values.

Characteristics of all CM-UFD.M* devices

- Monitoring of voltage and frequency in single- and three-phase mains (2-wire, 3-wire or 4-wire AC systems)
- CM-UFD.M*M with Modbus RTU
- Multiline, backlit LCD display
- True RMS measuring principle
- Over- and undervoltage, 10 minutes average value as well as over- and underfrequency monitoring
- Two-level threshold settings for over-/undervoltage and frequency
- ROCOF (rate of change of frequency) monitoring configurable
- Interrupted neutral detection
- All threshold values and tripping delays adjustable
- Error memory for up to 99 entries (incl. cause of error, measured value, relative timestamp)
- Password setting protection
- 3 control inputs, e.g. for feedback signal, remote trip
- 3 c/o (SPDT) contacts
- LEDs for the indication of operational states

Further characteristics CM-UFD.M22 / CM-UFD.M22M

- Third party certificate confirming accordance with CEI 0-21
- Autotest function
- Pre-setting according to CEI 0-21

Further characteristics CM-UFD.M31 / CM-UFD.M31M

- Vector shift detection configurable
- Test function
- Third party certificate confirming accordance with VDE-AR-N 4105 and BDEW
- Pre-settings according to VDE-AR-N 4105 and BDEW

Further characteristics CM-UFD.M33 / CM-UFD.M33M

- Vector shift detection configurable
- Test function
- Factory certificate confirming accordance with Engineering Recommendations G59/3 and G83/2
- Pre-settings according to G59/3 LV + G83/2 HV
- UL 508, CAN/CSA C22.2 No.14

Further characteristics CM-UFD.M34 / CM-UFD.M34M

- Vector shift detection configurable
- Autotest function
- Third party certificate confirming accordance with the DRRG standard of DEWA
- Pre-settings according to the DRRG standard of DEWA

Example: CM-UFD.M22M

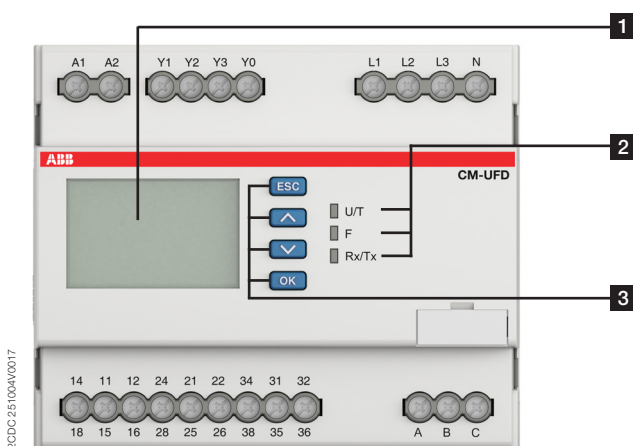

1 Display

R1 R2 R3 - relay status; in this case R3 is de-energized
 FB - status feedback loop Y0-Y1; in this case FB is closed
 EXT - status input external signal; in this case input is closed
 REM - status remote trip input; in this case input is closed

2 Indication of operational states

U/T: green LED - supply voltage applied / flashing = timing active
 F: red LED - failure
 Rx/Tx: yellow LED - frame reception and transmission

3 Keypad

ESC: escape / return to previous menu
 ^: up / value increase
 v: down / value decrease
 OK: enter / confirm selection

Grid feeding monitoring relays - Voltage and frequency monitoring functions Selection table - Ordering details



CM-UFD.M*

2CDC 251 003 S0017

Type	Order number							
CM-UFD.M22	1SVR560730R3400							
CM-UFD.M22M	1SVR560731R3700							
CM-UFD.M31	1SVR560730R3401							
CM-UFD.M31M	1SVR560731R3701							
CM-UFD.M33	1SVR560730R3402							
CM-UFD.M33M	1SVR560731R3702							
CM-UFD.M34	1SVR560730R3403							
CM-UFD.M34M	1SVR560731R3703							
Rated control supply voltage U_s								
24-240 V AC/DC		■	■	■	■	■	■	■
Standard								
CEI 0-21		■	■					
VDE AR-N 4105, BDEW				■	■			
G59/3; G83/2						■	■	
DRRG standard of DEWA							■	■
Modbus RTU								
			■		■		■	■
Suitable for monitoring								
Single-phase mains		■	■	■	■	■	■	■
Three-phase mains		■	■	■	■	■	■	■
Monitoring function								
Over-/undervoltage		■	■	■	■	■	■	■
Over-/underfrequency		■	■	■	■	■	■	■
ROCOF (rate of change of frequency)		■	■	■	■	■	■	■
10 minutes average value		■	■	■	■	■	■	■
Vector shift				■	■	■	■	■
Thresholds								
		adj	adj	adj	adj	adj	adj	adj

Ordering details

Description	Type	Order code	Price 1 pc	Weight (1 pc) kg (lb)
see above selection table	CM-UFD.M22	1SVR560730R3400		0.304 (0.670)
	CM-UFD.M22M	1SVR560731R3700		0.312 (0.688)
	CM-UFD.M31	1SVR560730R3401		0.304 (0.670)
	CM-UFD.M31M	1SVR560731R3701		0.312 (0.688)
	CM-UFD.M33	1SVR560730R3402		0.304 (0.670)
	CM-UFD.M33M	1SVR560731R3702		0.312 (0.688)
	CM-UFD.M34	1SVR560730R3403		0.304 (0.670)
	CM-UFD.M34M	1SVR560731R3703		0.312 (0.688)



Further documentation grid feeding monitoring relays on www.abb.com

Insulation monitoring relays for unearthed supply systems

Product group picture

2

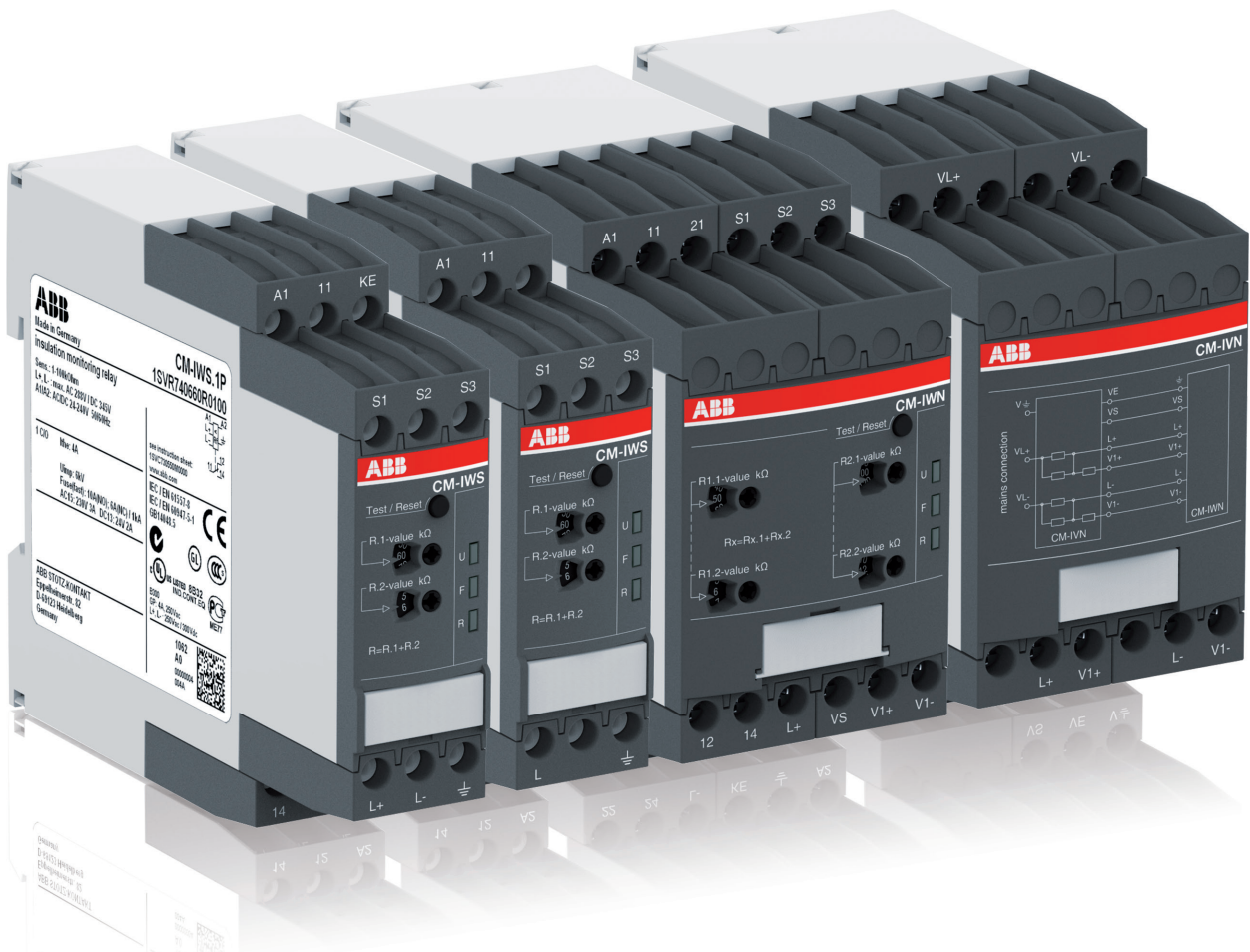

Insulation monitoring relays for unearthed supply systems

Table of contents

Insulation monitoring relays for unearthed supply systems

Benefits and advantages, Applications	2/53
Selection table - Insulation monitoring relays	2/54
Ordering details	2/55
Technical data - CM-IWx	2/56
Technical data - CM-IVN	2/59
Technical data - CM-IWM	2/60

Insulation monitoring relays for unearthed supply systems

Benefits and advantages, Applications

Overview

The CM-IWx product family offers a convincing solution for monitoring ungrounded AC, AC/DC and DC networks according to EN/IEC 61557-8. An IT network is supplied either by an isolated transformer or a voltage source such as a battery or generator. In these systems no active conductor is directly connected to earth potential.

The high reliability of an IT system is guaranteed thanks to continuous insulation monitoring. The insulation monitoring device recognizes insulation faults (at least one conductor has a galvanic connection to earth potential) as they develop and immediately reports if the insulation resistance has fallen below a given threshold. Therefore, maintenance activities can be scheduled and executed while the plant keeps running.

Benefits:

- Increase plant availability and avoid costly unplanned stops of a plant / machine by quickly detecting first faults
- Prevents fires due to detection of a creeping deterioration of the insulation resistance
- The adjustment of the setting values is simple and user friendly done with rotary switches on the front of the device
- Device status is displayed with LEDs that are easy to read and understand

Application

CM-IWS.x and CM-IWN.x series provide excellent insulation monitoring for general purpose supply networks such as

- Non-earthed AC, DC, AC/DC networks
- UPS systems
- Battery networks
- Hybrid and battery-powered vehicles
- Railway applications
- Many more

CM-IWM.x can be additionally used in special applications such as

- Industrial networks with frequency inverters or direct current drives
- Photovoltaic systems with high system leakage capacitance
- Networks with system voltages up to 1500 V DC or 1100 V AC without requiring a coupling unit
- Installation on the AC or DC side of an inverter
- Networks which require measuring circuit deactivation in case two or more unearthed networks are coupled

Note:

Only one insulation monitor must be connected and active in a network at the same time.



Insulation monitoring relays for unearthed supply systems

Selection table - Insulation monitoring relays

Type	Order number	CM-1WS.2S	CM-1WS.2P	CM-1WS.1S	CM-1WS.1P	CM-1WN.1S	CM-1WN.1P	CM-1WM.10	CM-1WM.11
Rated control supply voltage U_s									
24 - 240 V AC/DC		■	■	■	■	■	■		
24 V DC								■	■
Measuring voltages									
250 V AC (L-PE)			■	■					
400 V AC (L-PE)		■	■			■	■		
690 V AC (L-PE)						■ ¹⁾	■ ¹⁾	■ ²⁾	
1000 V AC (L-PE)									■ ³⁾
300 V DC (L-PE)			■	■					
600 V DC (L-PE)						■	■		
690 V DC (L-PE)								■ ²⁾	
1000 V DC (L-PE)						■ ¹⁾	■ ¹⁾		■ ³⁾
Measuring range									
1 - 100 k Ω		■	■	■	■	■	■		
2 - 200 k Ω						■	■		
1 - 250 k Ω								■	■
System leakage capacitance, max.									
10 μ F		■	■	■	■				
20 μ F						■	■		
1000 μ F								■	
3000 μ F									■
Output									
1 c/o		■	■	■	■				
1 x 2 c/o or 2 x 1 c/o						■	■		
2 c/o								■	■
Operating principle									
Open-circuit principle		■	■	■	■			■	■
Open- or closed-circuit principle adjustable						■	■		
Test									
Front-face button or control input		■	■	■	■	■	■	■	■
Reset and further functions									
Front-face button or control input		■	■	■	■	■	■	■	■
Fault storage / latching configurable		■	■	■	■	■	■		
Non volatile storage configurable		■	■	■	■	■	■		
Interrupted wire detection						■	■	■	■
Threshold values configurable		1	1	1	1	2	2	2	2
Control input (measuring input deactivation)									■
Connection type									
Push-in terminals			■		■		■		
Double-chamber cage connection terminals		■		■		■			
Screw terminals								■	■

1) With coupling unit CM-IVN screw version CM-IVN.S: 1SVR750669R9400
 push-in version CM-IVN.P: 1SVR760669R9400
 2) Allowed voltage range of the supervised network: 0-760 V AC / 0-1000 V DC
 3) Allowed voltage range of the supervised network: 0-1100 V AC / 0-1500 V DC



Further documentation insulation monitoring relays on www.abb.com

Insulation monitoring relays for unearthed supply systems

Ordering details

2

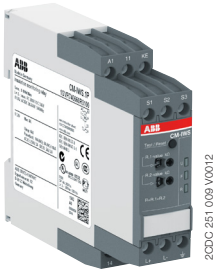

CM-IWS.1

2CDC 251 009 V0012

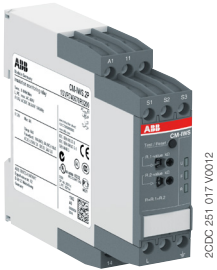

CM-IWS.2

2CDC 251 011 V0012



CM-IWN.1

2CDC 251 020 V0012



CM-IWM.x

2CDC 112 xxx V0016



CM-IVN

2CDC 252 027 V0012

Description

The CM-IWx serves to monitor insulation resistance in accordance with IEC 61557-8 in unearthed IT AC systems, IT AC systems with galvanically connected DC circuits, or IT DC systems. The devices are able to monitor control circuits (single-phase) and main circuits (3-phase).

Ordering details

Rated control supply voltage	Nominal voltage U_n of the distribution system to be monitored	System leakage capacitance, max.	Adjustment range of the specified response value R_{an} (threshold)	Type	Order code	Price	Weight (1 pc)
						1 pc	kg (lb)
24-240 V AC/DC	0-250 V AC / 0-300 V DC	10 μ F	1-100 k Ω	CM-IWS.1S	1SVR730660R0100		0.148 (0.326)
				CM-IWS.1P	1SVR740660R0100		0.137 (0.302)
	CM-IWS.2S			1SVR730670R0200		0.141 (0.311)	
	CM-IWS.2P			1SVR740670R0200		0.130 (0.287)	
	0-400 V AC			CM-IWN.1S	1SVR750660R0200		0.241 (0.531)
				CM-IWN.1P	1SVR760660R0200		0.217 (0.478)
	0-400 V AC / 0-600 V DC	20 μ F	1-100 k Ω / 2-200 k Ω				

Description

The CM-IWM.x provides best and up to date insulation monitoring of modern IT supply systems in an optimum and state of the art way according to IEC 61558-8 including annex C.

The device can be used in the most flexible way for AC, DC and AC/DC systems even with a large leakage capacity to earth (PE) and under adverse conditions.

Ordering details

Rated control supply voltage	Nominal voltage U_n of the distribution system to be monitored	System leakage capacitance, max.	Adjustment range of the specified response value R_{an} (threshold)	Type	Order code	Price	Weight (1 pc)
						1 pc	kg (lb)
24 V DC	0-690 V AC/DC ¹⁾	1000 μ F	1-250 k Ω / 20 k Ω -2 M Ω	CM-IWM.10	1SVR470670R1000		0.500 (1.1)
	0-1000 V AC/DC ²⁾			CM-IWM.11	1SVR470670R1100		

1) Allowed voltage range of the supervised network: 0-760 V AC / 0-1000 V DC

2) Allowed voltage range of the supervised network: 0-1100 V AC / 0-1500 V DC

Ordering details - Coupling unit

Rated control supply voltage = measuring voltage	Nominal voltage U_n of the distribution system to be monitored	Type	Order code	Price	Weight (1 pc)
				1 pc	kg (lb)
Passive device, no control supply voltage needed	0-690 V AC / 0-1000 V DC	CM-IVN.S	1SVR750669R9400		0.179 (0.395)
		CM-IVN.P	1SVR760669R9400		0.165 (0.364)

S: screw connection

P: push-in connection

Insulation monitoring relays for unearthed supply systems

Technical data - CM-IWx

Data at $T_a = 25\text{ }^\circ\text{C}$ and rated values, unless otherwise indicated

		CM-IWS.2	CM-IWS.1	CM-IWN.1
Input circuit - Supply circuit		A1 - A2		
Rated control supply voltage U_s		24-240 V AC/DC		
Rated control supply voltage tolerance		-15...+10 %		
Typical current / power consumption		24 V DC 115 V AC 230 V AC	30 mA / 0.7 VA 35 mA / 0.9 VA 17 mA / 2.0 VA 14 mA / 3.2 VA	55 mA / 1.3 VA 20 mA / 2.3 VA 15 mA / 3.5 VA
Rated frequency f_s		DC or 15-400 Hz		
Frequency range AC		13.5-440 Hz		
Power failure buffering time	min.	20 ms		
Start-up time t_s , fixed		min. 10 s	max. 15 s	min. 15 s
Input circuit - Measuring circuit		L, \downarrow	L+, L-, \downarrow, KE	L+, L-, \downarrow, KE
Monitoring function		insulation resistance monitoring of IT systems		
Measuring principle		superimposed DC voltage	prognostic measuring principle with superimposed square wave signal	
Nominal voltage U_n of the distribution system to be monitored		0-400 V AC	0-250 V AC / 0-300 V DC	0-400 V AC / 0-600 V DC
Voltage range of the distribution system to be monitored		0-460 V AC (tolerance +15 %)	0-287.5 V AC / 0-345 V DC (tolerance +15 %)	0-460 V AC / 0-690 V DC (tolerance +15 %)
Rated frequency f_N of the distribution system to be monitored		50-60 Hz	DC or 15-400 Hz	DC or 15-400 Hz
System leakage capacitance C_e	max.	10 μF		20 μF
Tolerance of the rated frequency f_N		45-65 Hz	13.5-440 Hz	13.5-440 Hz
Extraneous DC voltage U_{ig} (when connected to an AC system)	max.	none	290 V DC	460 V DC
Number of possible response / threshold values		1		2
Adjustment range of the specified response value R_{an} (threshold)	min.-max. min.-max. R1 min.-max. R2	1-100 Ω - -		1-100 k Ω 2-200 k Ω (activated / de-activated by DIP- switch)
Adjustment resolution		1 k Ω R1 1 k Ω R2 -		1 k Ω 2 k Ω
Tolerance of the adjusted threshold value / Relative percentage uncertainty A at -5...+45 $^\circ\text{C}$, $U_n = 0-115\%$, $U_s = 85-110\%$, $f_N, f_s, C_e = 1\mu\text{F}$	(yellow marked scale)	at 1-10 k Ω R_F $\geq 15\%$, max. ± 0.5 k Ω at 10-100 k Ω R_F $\pm 6\%$ at 10-15 k Ω R_F - at 15-200 k Ω R_F -		$\geq 15\%$, max. ± 1 k Ω , with CM-IVN ± 1.5 k Ω - ± 1 k Ω , with CM-IVN ± 1.5 k Ω $\pm 8\%$
Hysteresis related to the threshold value		25 %; min. 2 k Ω		
Internal impedance Z_i	at 50 Hz	135 k Ω	100 k Ω	155 k Ω
Internal DC resistance R_i		185 k Ω	115 k Ω	185 k Ω
Measuring voltage U_m		15 V	22 V	24 V
Tolerance of measuring voltage U_m		+10 %		
Measuring current I_m	max.	0.1 mA	0.3 mA	0.15 mA
Response time t_{an}	pure AC system DC system or AC system with connected rectifiers	$0.5 \times R_{an}$ and $C_e = 1\mu\text{F}$ -	max. 10 s max. 15 s	
Repeat accuracy (constant parameters)		< 0.1 % of full scale		
Accuracy of R_a (measured value) within the rated control supply voltage tolerance		< 0.05 % of full scale		
Accuracy of R_a (measured value) within the operation temperature range	at 1-10 k Ω R_F at 10-100 k Ω R_F at 10-200 k Ω R_F	5 Ω / K 0.05 % / K -		- 0.05 % / K
Transient overvoltage protection (\downarrow - terminal)		Z-diode	avalanche diode	
Input circuit - Control circuits		S1 - S2 - S3		
Control inputs - volt free	S1-S3 S2-S3	remote test remote reset		
Maximum switching current in the control circuit		1 mA		
Maximum cable length to the control inputs		50 m - 100 pF/m		
Minimum control pulse length		150 ms		
No-load voltage at the control input		≤ 24 V $\pm 5\%$	≤ 24 V DC	

Insulation monitoring relays for unearthed supply systems

Technical data - CM-IWx

2

	CM-IWS.2	CM-IWS.1	CM-IWN.1
Indication of operational states			
Control supply voltage	LED U (green)		
Fault message	LED F (red)		
Relay status	LED R (yellow)		
Output circuits			
Kind of output	relay, 1 c/o (SPDT) contact		2 x 1 or 1 x 2 c/o (SPDT) contacts configurable
Operating principle	closed-circuit principle ¹⁾		open- or closed circuit principle ¹⁾ configurable
Contact material	AgNi alloy, Cd free		
Min. switching voltage / Min. switching current	24 V / 10 mA		
Max. switching voltage / Max. switching current	see data sheet		
Rated operational voltage U_n and rated operational current I_n	AC-12 (resistive) at 230 V	4 A	
	AC-15 (inductive) at 230 V	3 A	
	DC-12 (resistive) at 24 V	4 A	
	DC-13 (inductive) at 24 V	2 A	
AC rating (UL 508)	utilization category B 300 pilot duty; general purpose 250 V, 4 A, $\cos \varphi$ 0.75		
	(Control Circuit Rating Code)		
	max. rated operational voltage	250 V AC	
	max. continuous thermal current at B 300	4 A	
	max. making/breaking apparent power at B 300	3600/360 VA	
Mechanical lifetime	30 x 10 ⁶ switching cycles		
Electrical lifetime (AC-12, 230 V, 4 A)	0.1 x 10 ⁶ switching cycles		
Max. fuse rating to achieve short-circuit protection	n/c contact	6 A fast-acting	
	n/o contact	10 A fast-acting	
Conventional thermal current I_{th}	4 A		
General data			
Duty cycle	100 %		
Dimensions	see 'Dimensional drawings'		
Mounting	DIN rail (IEC/EN 60715), snap-on mounting without any tool		
Mounting position	any		
Minimum distance to other units	vertical	not necessary	
	horizontal	10 mm (0.39 in) at $U_n > 240$ V	not necessary
Material of housing	UL 94 V-0		
Degree of protection	housing / terminal	IP50 / IP20	
Electrical connection			
		Screw connection technology	Easy Connect Technology (Push-in)
Connecting capacity	fine-strand with(out) wire end ferrule	rigid	2 x 0.5-1.5 mm ² (2 x 18-16 AWG)
			2 x 0.5-2.5 mm ² (2 x 18-16 AWG)
			2 x 0.5-1.5 mm ² (2 x 20-16 AWG)
Stripping length		1 x 0.5-4 mm ² (1 x 20-12 AWG)	2 x 0.5-1.5 mm ² (2 x 20-16 AWG)
Tightening torque		2 x 0.5-2.5 mm ² (2 x 20-14 AWG)	
Environmental data			
Ambient temperature ranges	operation / storage / transport	-25...+60 °C/-40...+85 °C/-40...+85 °C	
Climatic class	IEC/EN 60721-3-3	3K5 (no condensation, no ice formation)	
Damp heat, cyclic	IEC/EN 60068-2-30	6 x 24 h cycle, 55 °C, 95 % RH	
Vibration, sinusoidal		25 Hz: 2.5 g	

¹⁾ Closed-circuit principle: Output relay(s) de-energize(s) if a fault is occurring
 Open-circuit principle: Output relay(s) energize(s) if a fault is occurring

Insulation monitoring relays for unearthed supply systems

Technical data - CM-IWx

		CM-IWS.2	CM-IWS.1	CM-IWN.1
Isolation data				
Rated impulse withstand voltage U_{imp}	supply / measuring circuit	6 kV		
	supply / output circuit	6 kV		
	measuring / output circuit	6 kV		
Rated insulation voltage U_i	output 1 / output circuit 2			4 kV
	supply / measuring circuit	400 V	300 V	600 V
	supply / output circuit	300 V		
Basic insulation	supply / measuring circuit	400 V	300 V	600 V
	output 1 / output circuit 2	-	-	300 V
	supply / output circuit	400 V AC / 300 V DC	250 V AC / 300 V DC	400 V AC / 600 V DC
Protective separation (IEC/EN 61140, EN 50178)	supply / output circuit	250 V AC / 300 V DC	250 V AC / 300 V DC	400 V AC / 600 V DC
	measuring / output circuit	400 V AC / 300 V DC	250 V AC / 300 V DC	400 V AC / 600 V DC
	output 1 / output 2	250 V AC / 300 V DC		
Pollution degree	supply / output circuit	250 V AC / 250 V DC		
	supply / measuring circuit	250 V AC / 250 V DC		
Overvoltage category	measuring / output circuit	250 V AC / 250 V DC		
		3		
Standards / Directives				
Standards		IEC/EN 60947-5-1, IEC/EN 61557-1, IEC/EN 61557-8		
Low Voltage Directive		2014/35/EU		
EMC Directive		2014/30/EU		
RoHS Directive		2011/65/EU		
Electromagnetic compatibility				
Interference immunity to		IEC/EN 61000-6-2, IEC/EN 61326-2-4		
electrostatic discharge	IEC/EN 61000-4-2	level 3, 6 kV / 8 kV		
radiated, radio-frequency, electromagnetic field	IEC/EN 61000-4-3	level 3, 10 V/m (1 GHz) / 3 V/m (2 GHz) / 1 V/m (2.7 GHz)		
electrical fast transient/burst	IEC/EN 61000-4-4	level 3, 2 kV / 5 kHz		
surge	IEC/EN 61000-4-5	level 3, installation class 3, supply circuit and measuring circuit 1 kV L-L, 2 kV L-earth		
conducted disturbances, induced by radio-frequency fields	IEC/EN 61000-4-6	level 3, 10 V		
voltage dips, short interruptions and voltage variations	IEC/EN 61000-4-11	class 3		
harmonics and interharmonics	IEC/EN 61000-4-13	class 3		
Interference emissions		IEC/EN 61000-6-3		
high-frequency radiated	IEC/CISPR 22, EN 55022	class B		
high-frequency conducted	IEC/CISPR 22, EN 55022	class B		

Insulation monitoring relays for unearthed supply systems

Technical data - CM-IVN

2

Input circuit - Measuring circuit		VL+, VL-, V+
Function	expansion of the nominal voltage range of the insulation monitoring relay CM-IWN to 690 V AC or 1000 V DC, max. length of connection cable 40 cm	
Measuring principle	see CM-IWN	
Nominal voltage U_n of the distribution system to be monitored	0-690 V AC / 0-1000 V DC	
Voltage range of the distribution system to be monitored	0-793.5 V AC / 0-1150 V DC (tolerance +15 %)	
Rated frequency f_N of the distribution system to be monitored	DC or 15-400 Hz	
Tolerance of the rated frequency f_N	13.5-440 Hz	
System leakage capacitance C_s	max.	identical to that of the insulation monitoring relay used
Extraneous DC voltage U_{ig} (when connected to an AC system)	max.	793.5 V DC
Tolerance of the adjusted threshold value / Relative percentage uncertainty A at	at 1-15 k Ω R_F	± 1.5 k Ω
-5...+45 °C, $U_n = 0-115$ %, $U_s = 85-110$ %, $f_N, f_{st}, C_s = 1$ μ F	at 15-200 k Ω R_F	± 8 %
Internal impedance Z	at 50 Hz	195 k Ω
Internal DC resistance R_i		200 k Ω
Measuring voltage U_m		24 V
Tolerance of measuring voltage U_m		+10 %
Measuring current I_m		0.15 mA
General data		
MTBF	on request	
Duty cycle	100 %	
Dimensions	see "Dimensional drawings"	
Mounting	DIN rail (IEC/EN 60715), snap-on mounting without any tool	
Mounting position	any	
Minimum distance to other units	vertical	not necessary
	horizontal	10 mm (0.39 in) at $U_n > 600$ V
Degree of protection	IP50 / IP20	
Electrical connection		
Connecting capacity	fine-strand with(out) wire end ferrule	2 x 0.75-2.5 mm ² (2 x 18-14 AWG)
	rigid	2 x 0.5-4 mm ² (2 x 20-12 AWG)
Stripping length	7 mm (0.28 in)	
Tightening torque	0.6-0.8 Nm (5.31-7.08 lb.in)	
Max. length of connection cable to CM-IWN	40 cm	
Environmental data		
Ambient temperature ranges	operation / storage / transport	-25...+60 °C / -40...+85 °C / -40...+85 °C
Climatic category	IEC/EN 60721-3-3	3K5 (no condensation, no ice formation)
Damp heat, cyclic	IEC/EN 60068-2-30	6 x 24 h cycle, 55 °C, 95 % RH
Vibration, sinusoidal	IEC/EN 60255-21-1	Class 2
Shock, half-sine	IEC/EN 60255-21-2	Class 2
Isolation data		
Rated impulse withstand voltage U_{imp}	input circuit / PE	8 kV
Rated insulation voltage U_i	input circuit / PE	1000 V
Pollution degree		3
Overvoltage category		III
Standards / Directives		
Standards	IEC/EN 60947-5-1, IEC/EN 61557-1, IEC/EN 61557-8	
Low Voltage Directive	2014/35/EU	
EMC Directive	2014/30/EU	
RoHS Directive	2011/65/EU	
Electromagnetic compatibility		
Interference immunity to	IEC/EN 61000-6-2, IEC/EN 61326-2-4	
electrostatic discharge	IEC/EN 61000-4-2	level 3, 6 kV / 8 kV
radiated, radio-frequency, electromagnetic field	IEC/EN 61000-4-3	level 3, 10 V/m (1 GHz) / 3 V/m (2 GHz) / 1 V/m (2.7 GHz)
electrical fast transient/burst surge	IEC/EN 61000-4-4	level 3, 2 kV / 5 kHz
	IEC/EN 61000-4-5	level 3, installation class 3, supply circuit and measuring circuit 1 kV L-L, 2 kV L-earth
conducted disturbances, induced by radio-frequency fields	IEC/EN 61000-4-6	level 3, 10 V
voltage dips, short interruptions and voltage variations	IEC/EN 61000-4-11	level 3
harmonics and interharmonics	IEC/EN 61000-4-13	Level 3
Interference emission	IEC/EN 61000-6-3	
high-frequency radiated	IEC/CISPR 22, EN 50022	class B
high-frequency conducted	IEC/CISPR 22, EN 50022	class B

Insulation monitoring relays for unearthed supply systems

Technical data - CM-IWM

Type	CM-IWM.10	CM-IWM.11
Input circuit		
Rated control supply voltage U_s	24 V DC	
Voltage range	20-30 V DC	
Typical power consumption	max. 5 W	
Measuring circuit		
	L(+) / L(-) to PE / KE	
Nominal voltage U_N	0-690 V AC/DC	0-1000 V AC/DC
Allowed voltage range of the supervised network	0-760 V AC / 0-1000 V DC	0-1100 V AC / 0-1500 V DC
Frequency range	DC or 16-1000 Hz	DC or 16-1000 Hz
Max. system leakage capacitance C_E	1000 μ F	3000 μ F
Internal resistance (AC/DC)	> 280 k Ω	
Measuring voltage	approx. \pm 95 V	
Max. measured current ($R_E = 0$)	< 0.35 mA	
Response values R_E each adjustable via rotary switches	pre-warning ("VW")	warning ("AL")
	20 k Ω	1 k Ω
	30 k Ω	3 k Ω
	50 k Ω	10 k Ω
	70 k Ω	20 k Ω
	100 k Ω	30 k Ω
	150 k Ω	50 k Ω
	250 k Ω	70 k Ω
	500 k Ω	100 k Ω
	1000 k Ω	150 k Ω
	2000 k Ω	250 k Ω
Response inaccuracy	IEC/EN 61557-8	\pm 15 % + 1.5 k Ω
Response value hysteresis	at range 10 k Ω ... 700 k Ω out of range:	approx. 25 % approx. 40 % + 0.5 k Ω
ON delay	at $C_E = 1 \mu$ F R_E of ∞ to 0.5 * response value	< 10 s
Control input		
Current flow	between T, R and G	between HM, T, R and G
No-load voltage to ground	approx. 12 V	
Permissible wire length	< 50 m	
Min. activation time	0.5 s	
Output		
Contacts	2 x 1 c/o contacts for VW and AL	
Thermal current I_{th}	4 A	
Switching capacity to AC-15	n/o contact	3 A / AC 230 V acc. to IEC/EN 60947-5-1
	n/c contact	1 A / AC 230 V acc. to IEC/EN 60947-5-1
Electrical life	at 8 A, AC 250 V	1 x 10 ⁵ switching cycles
Short circuit strength max. fuse rating	4 A gL acc. to IEC/EN 60947-5-1	
Mechanical life	10 x 10 ⁶ switching cycles	
General Data		
Operating mode	continuous operation	
Temperature range	operation	- 25 ... + 60 °C
	storage	- 40 ... + 70 °C
Relative air humidity	93 % at 40 °C	
Atmospheric pressure	860-1600 mbar (86-106 kPa)	
Altitude IEC/EN 60664-1	< 4000 m	
Clearance and creepage distances	IEC/EN 60664-1	
Rated impulse voltage / pollution degree	8 kV / 2	
Measuring circuit auxiliary voltage DC and relay contacts VW, AL	8 kV / 2	
L(+) / L(-) to auxiliary voltage DC to relay contacts VW, AL	8 kV / 2	
relay contacts VW to relay contact AL	4 kV / 2	
Insulation test voltage, routine test	AC 5 kV; 1 s AC 2.5 kV; 1 s	

Insulation monitoring relays for unearthed supply systems

Technical data CM-IWM

2

Technical data		
EMC		
Electrostatic discharge (ESD)	IEC/EN 61000-4-2	8 kV (air)
HF irradiation	IEC/EN 61000-4-3	80 MHz-2.7 GHz: 10 V/m
Fast transients	IEC/EN 61000-4-4	4 kV
Surge voltages	IEC/EN 61000-4-5	between A1 - A2: 1 kV L(+) - L(-): 2 kV A1, A2 - PE: 4 kV L(+), L(-) - PE: 4 kV control line: 0.5 kV control line and earth: 1 kV
HF-wire guided Interference suppression	IEC/EN 61000-4-6 EN 55011	10 V limit value class A when connected to a low voltage public system (Class B, EN 55011) radio interference can be generated. To avoid this, appropriate measures have to be taken
Degree of protection		
Housing	IEC/EN 60529	IP 40
Terminals	IEC/EN 60529	IP 20
Housing		thermoplastic with V0 behaviour according to UL subject 94
Vibration resistance	IEC/EN 60068-2-6	10-55 Hz: 0.35 mm 2-13.2 Hz: ± 1 mm 13.2-100 Hz: ± 7 g
Shock resistance	IEC/EN 60068-2-27	10 g / 11 ms, 3 pulses
Climate resistance	IEC/EN 60068-1	25 / 060 / 04
Terminal designation		
Connecting capacity		EN 50005 1 x 4 mm ² solid 1 x 2.5 mm ² stranded ferruled (isolated) 2 x 1.5 mm ² stranded ferruled (isolated) DIN 46228-1/-2/-3-4 2 x 2.5 mm ² stranded ferruled (isolated) DIN 46228-1/-2/-3
Stripping length		8 mm
Tightening torque		0.8 Nm
Wire fixing		plus-minus terminal screws M3.5 terminal with wire protection
Mounting	IEC/EN 60715	DIN rail
Dimensions	width x height x depth	90 x 90 x 121 mm

Insulation monitoring relays for unearthed supply systems

Notes

Motor control and protection

Product group picture

2



Motor control and protection

Table of contents

Motor control and protection

Benefits and advantages	2/65
Technical data	2/66

Motor control and protection

Benefits and advantages

2

UMC100.3 is a flexible, modular and expandable motor management system for constant-speed low-voltage range motors. It's most important tasks include motor protection, prevention of plant standstills and the reduction of down time. This is made possible by early information relating to possible motor problems which avoids unplanned plant standstills. Even if a motor trips, quick diagnosis of the cause of the fault serves to reduce downtime.

UMC100.3 combines in a very compact unit:

Motor protection

- Overload, underload
- Overvoltage, undervoltage
- Blocked rotor, low / high current
- Phase failure, imbalance, phase sequence
- Earth leakage
- Thermistor protection
- Limitation of starts per time
- One single version with integrated measuring system covers the rated motor current from 0.24 to 63 A

Motor control

- Integrated and easy to parametrize motor starter functions like direct, reverse, star-delta,...
- Additionally free programmable logic for application specific control functions
- Expansion modules DX111, DX122 for more I/Os
- Expansion modules VI150, VI155 for 3-phase voltage measuring
- Analog and temperature module AI111

Motor diagnostics

- Quick and comprehensive access to all relevant data via fieldbus and/or operator panel
- Current, thermal load
- Phase voltages
- Power factor
- Energy

Communication

- Communication-independent basic device
- Freely selectable fieldbus protocol with FieldBusPlug
- Profibus DP
- DeviceNet
- Modbus RTU
- Ethernet Modbus TCP
- EtherNet/IP
- Profinet

Typical application segments

- Oil & gas
- Cement
- Paper
- Mining
- Steel
- Chemical industry

Further information

UMC Catalog 2CDC 190 022 C0206
UMC Brochure 2CDC 135 011 B0204

Motor control and protection

Technical data

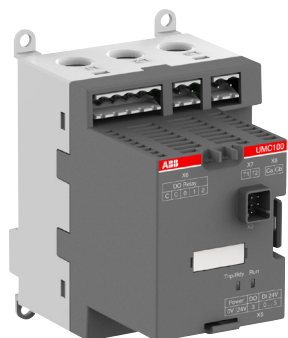

Basic devices UMC100.3

Versions with ATEX approval and conformal coating are available.

Main power

Voltage	max 1000 V AC
Frequency	45...65 Hz
Rated motor current	0.24...63 A, without accessories Higher currents with external transformer
Tripping classes	5E, 10E, 20E, 30E, 40E in accordance with IEC/EN 60947-4-1
Short-circuit protection	Separate fuse on network side

Control unit

Supply voltage	24 V DC, 110-240 V AC/DC
Inputs	6 digital inputs 24 V DC 1 PTC input
Outputs	3 digital relay outputs 1 digital transistor output

Expansion modules

The UMC100.3 can be expanded with maximum 4 expansion modules: One digital expansion module DX111 or DX122, one module VI150 or VI155 and 2 analog modules AI111.

Communication takes place via a simple two-wire line. The maximum distance allowed between the UMC100.3 and the expansion module is 3 m.



Digital expansion modules DX111 / DX122-FBP.0

expand the UMC100.3 to include additional digital inputs and outputs and an analog output

Supply voltage	24 V DC
Inputs	DX111: 8 digital inputs 24 V DC DX122 8 digital inputs 110/230 V AC
Outputs	4 digital relay outputs 1 analog output, 0/4...20 mA, / 0...10 V configurable

Voltage modules VI150/VI155-FBP.0

Voltage modules for determining phase voltages, power factor ($\cos \varphi$), active power, apparent power, energy, harmonic content (THD)

VI150 for use in grounded networks

VI155 for use in grounded and ungrounded networks

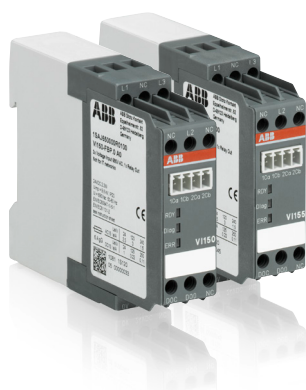

Supply voltage	24 V DC
Voltage inputs	L1, L2, L3
Rated voltage range	150 ... 690 V AC
Outputs	1 digital relay output

Analog module AI111.0

expands the UMC100.3 with analog and temperature inputs

Supply voltage	24 V DC
Inputs	0-10 V, 0/4-20 mA PT100, PT1000, 2- or 3-wire connection KTY83, KTY84, NTC

Motor control and protection

Technical data

2



Ethernet communication interfaces

Mounted in the MCC cable chamber; connection of 1 to 4 motor controllers UMC100.3 via simple cables

MTQ22-FBP.0	for Modbus TCP
PNQ22-FBP.0	for Profinet IO



Fieldbus communication interfaces

can be mounted directly on the UMC100.3 or separately in the cable chamber of the MCC.
Connection for standard fieldbus cables with 9-pole Sub-D (Profibus DP) or terminal blocks

PDP32.0	for Profibus DP
DNP31.0	for DeviceNet
MRP31.0	for Modbus RTU



CEM11 Earth leakage sensors

Summation current transformer for connecting to a digital input
Mounting with bracket on DIN busbar or wall

CEM11-FBP.20	80 – 1.700 mA	20 mm Ø
CEM11-FBP.35	100 – 3.400 mA	35 mm Ø
CEM11-FBP.60	120 – 6.800 mA	60 mm Ø
CEM11-FBP.120	300 – 13.600 mA	120 mm Ø

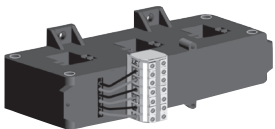

Current transformer CT4L / CT5L

Only required for rated motor currents >63 A
Linear transformer, 3-phase with terminal block, designed for connecting leads Cu 2.5 mm²



UMC100-PAN control panel

Installation on the device or on the switching cabinet door
Graphics-enabled and backlit display, 3 LEDs for status indication
Freely configurable error messages
USB port for PC connection
Multilingual: German, English, French, Italian, Polish, Portuguese, Spanish, Russian

Motor control and protection

Notes

Thermistor motor protection relays

Product group picture

2

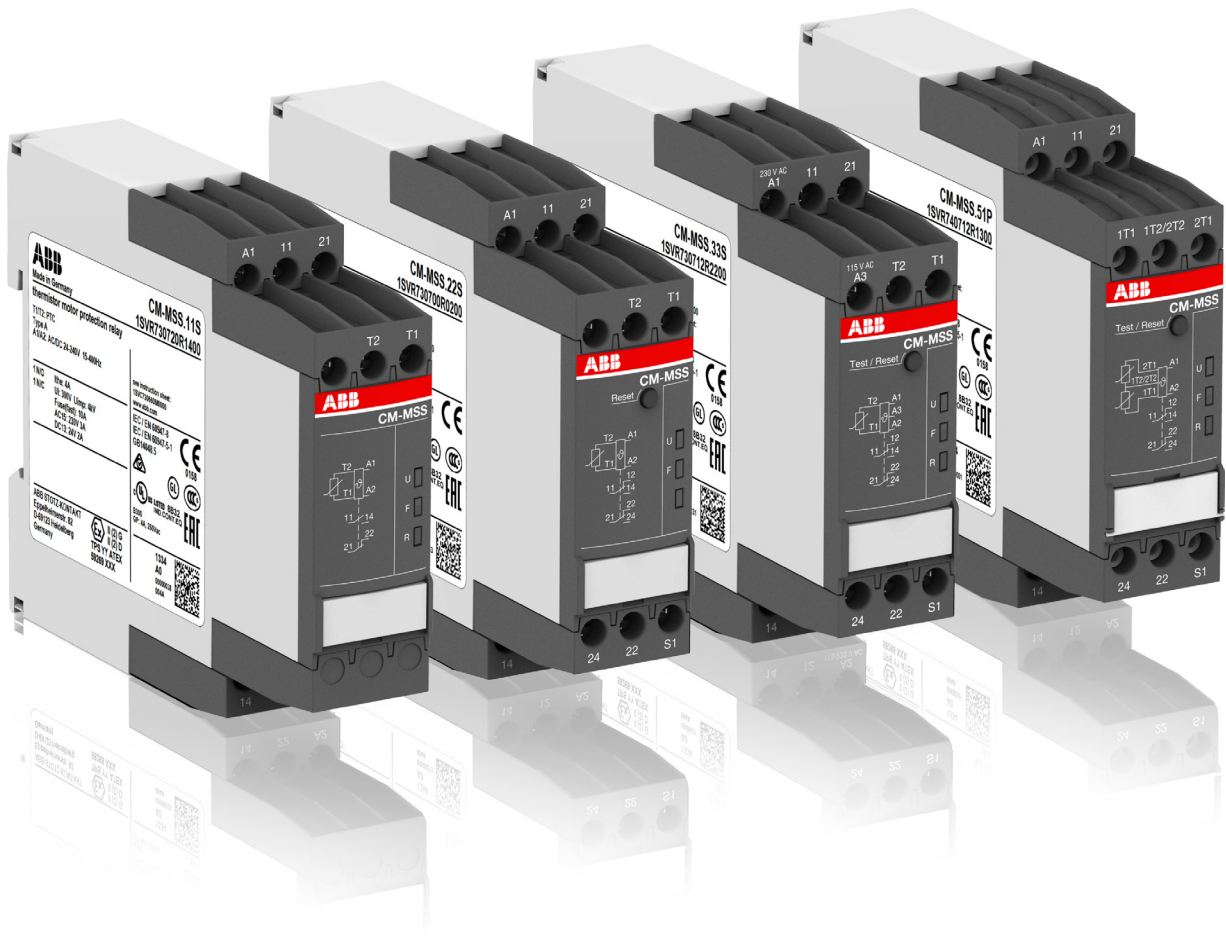

Thermistor motor protection relays

Table of contents

Thermistor motor protection relays

Benefits and advantages, Applications	2/71
Operating controls	2/72
Selection table - Thermistor motor protection relays	2/73
Ordering details	2/74
Ordering details - PTC temperature sensors C011	2/75
Technical data - CM-MSS	2/76
Technical data - CM-MSE	2/79
Connection diagrams	2/81
Circuit diagrams	2/82

Thermistor motor protection relays

Benefits and advantages, Applications

The thermistor motor protection relays of the CM-MSx range protect motors with PTC sensors against high temperature. These sensors are incorporated in the motor windings thus measuring the motor heat directly.

2

Direct temperature measuring

Generally, motor damages caused by overload or overheating situations can be prevented in different ways. Compared to the indirect temperature measuring which monitors the motor current, the temperature inside the motor can be measured by direct temperature measuring.

This enables direct control and evaluation of the following operating conditions like:

- Heavy duty starting
- Increased switching frequency
- Single phase operation
- Phase unbalance
- High ambient temperature
- Insufficient cooling
- Breaking operation

Therefore the consequences from overheating like abrasion as well as electrical failures can be prevented.

The direct measuring principle is carried out by a combination of the thermistor motor protection relay and 3 PTC sensors which are installed directly in the motor by the manufacturer. Those 3 PTC sensors are placed directly at the thermal hotspots, the motor windings.

Characteristics CM-MSS¹⁾

- Different types of contacts available
 - 1 x 2 c/o (SPDT) contacts
 - 2 x 1 c/o (SPDT) contact
 - 1 n/o and 1 n/c contact
- 1 or 2 measuring circuits
- Different types of reset functions
 - Automatic
 - Manual
 - Remote
- Rated control supply voltages
 - 24 V AC/DC
 - 24-240 V AC/DC
 - 110-130 V AC, 220-240 V AC
- Various approvals and marks

Characteristics CM-MSE

- Auto reset
- Connection of several sensors (max. 6 sensors connected in series)
- Monitoring of bimetals
- 1 n/o contact
- Excellent cost / performance ratio

Monitoring the motor

The thermistor motor protection relay measures the resistance of the PTC sensors which reflects the internal motor temperature permanently. If the temperature in the motor windings rises excessively and reaches the nominal response temperature (NRT), the thermistor motor protection relay detects this situation and the output relay switches off.

By doing so the motor contactor gets triggered and switches off the motor.

CM-MSS functionality video



Features ¹⁾

- Additional functions:
 - Dynamic interrupted wire detection
 - Short-circuit monitoring of the sensor circuit
 - Non-volatile fault storage
 - Single or sum evaluation
- Easy configuration via DIP switches
- LEDs to distinguish between different failure causes
- Screw connection technology or Easy Connect Technology available
- Test/Reset button available

¹⁾ Depending on device the characteristics vary, for detailed overview see "Selection table - Thermistor motor protection relays" on page 2/73.





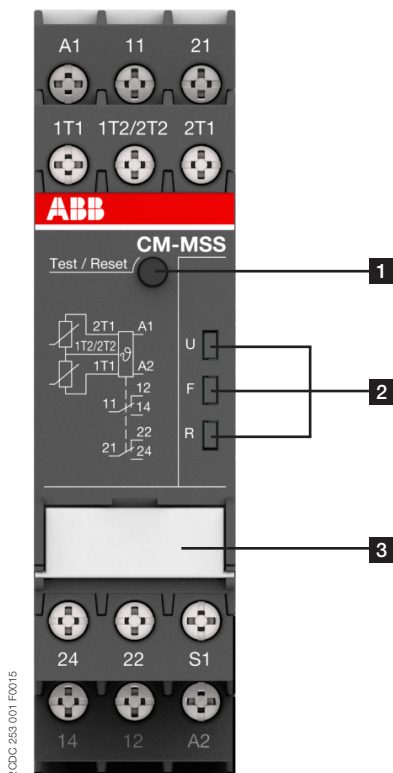

















Thermistor motor protection relays

Operating controls



- 1 Test / Reset button**
Reset - only possible if measured value < switch-on resistance
- 2 Indication of operational states with LEDs**
U: green LED - Status indication of control supply voltage
 Control supply voltage applied
 F: red LED - Fault message
 R: yellow LED - Status indication of the output relay
- 3 Marker label / DIP switches (depending on device)**

LEDs, status information and fault messages CM-MSS (in order of priority)

Operational state	U: green LED	F: red LED	R: yellow LED
Absence of control supply voltage	OFF	OFF	OFF
Internal fault ¹⁾	OFF		
Internal fault ¹⁾			
Control supply voltage not within the tolerance range			OFF
Short circuit			OFF
Interrupted wire			OFF
Measuring circuit 2: Overtemperature			OFF
Measuring circuit 1: Overtemperature			OFF
Fault rectified but not confirmed		-- ²⁾	
Test function		OFF	OFF
Change of configuration not confirmed		OFF	
No fault		OFF	

¹⁾ Depending on the fault with the highest priority

²⁾ Restart the device. If after restart the same fault is indicated, replace the device.

In case of several faults, the fault with the higher priority is shown. The reset can be made after rectification and confirmation of the last fault.

Thermistor motor protection relays

Selection table - Thermistor motor protection relays

Type	Order code	1SVR550805R9300	1SVR550800R9300	1SVR550801R9300	1SVR740720R1400	1SVR730720R1400	1SVR740700R0100	1SVR730700R0100	1SVR740700R2100	1SVR730700R2100	1SVR740722R1400	1SVR730722R1400	1SVR740700R0200	1SVR730700R0200	1SVR740700R2200	1SVR730700R2200	1SVR740712R1400	1SVR730712R1400	1SVR740712R0200	1SVR730712R0200	1SVR740712R2200	1SVR730712R2200	1SVR740712R1200	1SVR730712R1200	1SVR740712R1300	1SVR730712R1300	
Characteristics																											
ATEX approval				■	■					■	■						■	■	■	■	■	■	■	■	■	■	■
Number of sensor circuits	1	1	1	1	1	1	1	1	1	1	1	1	1	1	1	1	1	1	1	1	1	1	1	1	2	2	
Single or accumulative evaluation																								■	■		
Number of LEDs				3	3	2	2	2	2	3	3	2	2	2	2	3	3	3	3	3	3	3	3	3	3	3	
Contacts																											
1 c/o (SPDT) contact							■	■	■	■																	
2 c/o (SPDT) contacts													■	■	■	■			■	■	■	■	■	■	■	■	
1 n/o	■	■	■																								
1 n/c and 1 n/o				■	■					■	■						■	■									
2 x 1 c/o or 1 x 2 c/o contacts, configurable																								■	■		
Reset																											
Manual													■	■	■	■	■	■	■	■	■	■	■	■	■	■	■
Remote													■	■	■	■	■	■	■	■	■	■	■	■	■	■	■
Auto	■	■	■	■	■	■	■	■	■	■	■	■	■ ¹⁾	■ ¹⁾	■ ¹⁾	■ ¹⁾	■ ¹⁾	■ ¹⁾	■ ¹⁾	■ ¹⁾	■ ¹⁾	■ ¹⁾	■ ¹⁾	■ ¹⁾	■ ²⁾	■ ²⁾	
Test button																	■	■	■	■	■	■	■	■	■	■	
Functions																											
Short-circuit detection																	■	■	■	■	■	■	■	■	■	■	
Short-circuit detection, configurable																							■	■	■	■	
Dynamic interrupted wire detection				■	■								■	■			■	■	■	■	■	■	■	■	■	■	
Non-volatile fault storage				■	■								■	■			■	■									
Non-volatile fault storage, configurable																							■	■	■	■	
Rated control supply voltage U_s																											
24 V AC	■																										
110-130 V AC		■																									
220-240 V AC			■																								
24-240 V AC/DC				■	■								■	■			■	■					■	■	■	■	
24 V AC/DC						■	■						■	■					■	■							
110-130 V AC, 220-240 V AC								■	■						■	■						■	■				
Connection type																											
Push-in terminals				■		■		■		■		■		■		■		■		■		■		■		■	
Double-chamber cage connection terminals					■		■		■		■		■		■		■		■		■		■		■		

¹⁾ For automatic reset, connect terminals S1 to T2.
²⁾ For automatic reset, connect terminals S1 to 1T2/2T2.

Thermistor motor protection relays

Ordering details

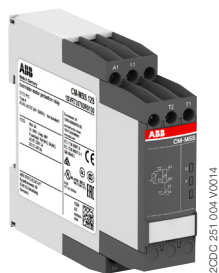

CM-MSS.12S

2CDC 251 004 V0014

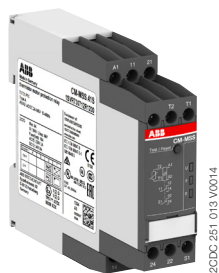

CM-MSS.41S

2CDC 251 013 V0014

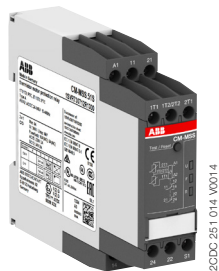

CM-MSS.51S

2CDC 251 014 V0014

Description

The thermistor motor protection relay CM-MSS monitors the winding temperature and thus protects the motor from overheating, overload and insufficient cooling in accordance to the product standard IEC/EN 60947-8.

Ordering details CM-MSx

Characteristics	Type	Order code	Price	Weight
			1 pc	(1 pc) kg (lb)
	CM-MSE	1SVR550805R9300		0.11 (0.24)
	CM-MSE	1SVR550800R9300		0.11 (0.24)
	CM-MSE	1SVR550801R9300		0.11 (0.24)
	CM-MSS.11P	1SVR740720R1400		0.119 (0.263)
	CM-MSS.11S	1SVR730720R1400		0.127 (0.280)
	CM-MSS.12P	1SVR740700R0100		0.105 (0.231)
	CM-MSS.12S	1SVR730700R0100		0.113 (0.249)
	CM-MSS.13P	1SVR740700R2100		0.147 (0.324)
	CM-MSS.13S	1SVR730700R2100		0.155 (0.342)
	CM-MSS.21P	1SVR740722R1400		0.118 (0.260)
	CM-MSS.21S	1SVR730722R1400		0.126 (0.278)
	CM-MSS.22P	1SVR740700R0200		0.121 (0.267)
	CM-MSS.22S	1SVR730700R0200		0.132 (0.291)
	CM-MSS.23P	1SVR740700R2200		0.163 (0.359)
	CM-MSS.23S	1SVR730700R2200		0.174 (0.384)
	CM-MSS.31P	1SVR740712R1400		0.120 (0.265)
	CM-MSS.31S	1SVR730712R1400		0.128 (0.282)
	CM-MSS.32P	1SVR740712R0200		0.120 (0.265)
	CM-MSS.32S	1SVR730712R0200		0.130 (0.287)
	CM-MSS.33P	1SVR740712R2200		0.162 (0.357)
	CM-MSS.33S	1SVR730712R2200		0.172 (0.379)
	CM-MSS.41P	1SVR740712R1200		0.130 (0.287)
	CM-MSS.41S	1SVR730712R1200		0.141 (0.311)
	CM-MSS.51P	1SVR740712R1300		0.135 (0.298)
	CM-MSS.51S	1SVR730712R1300		0.145 (0.320)

See "Selection table - Thermistor motor protection relays" on page 2/73.

S: screw connection
P: push-in connection



Further documentation thermistor motor protection monitoring relays on www.abb.com

Thermistor motor protection relays

Ordering details - PTC temperature sensors C011

2



1SWC 110 000 F0531

Temperature sensor characteristics

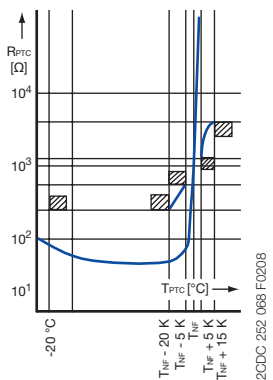

2CDC 252 068 F0208

Description

The PTC temperature sensors (temperature-dependent with positive temperature coefficient) are selected by the manufacturer of the motor depending on:

- the motor insulation class according to IEC/EN 60034-11,
- the special characteristics of the motor, such as the conductor cross-section of the windings, the permissible overload factor etc.
- special conditions prescribed by the user, such as the permissible ambient temperature, risks resulting from locked rotor, extent of permitted overload etc.

One temperature sensor must be embedded in each phase winding. For instance, in case of three-phase squirrel cage motors, three sensors are embedded in the stator windings. For pole-changing motors with one winding (Dahlander connection), 3 sensors are also sufficient. Pole-changing motors with two windings, however, require 6 sensors. The sensors are suitable for embedding in motor windings with rated operating voltages of up to 600 V AC. Conductor length: 500 mm per sensor. A 14 V varistor can be connected in parallel to protect the sensors from overvoltage. Due to their characteristics, the thermistor motor protection relays can also be used with PTC temperature sensors of other manufacturers which comply with DIN 44 081 and DIN 44 082.

If an additional warning is required before the motor is switched off, separate sensors for a correspondingly lower temperature must be embedded in the winding. They have to be connected to a second control unit.

Ordering details CM-MSS accessories

Rated response temperature T_{NF}	Color coding	Type	Order code	Price 1 pc	Weight (1 pc) kg (lb)
Temperature sensor C011, standard version acc. to DIN 44081 1 set = 3 pieces					
70 °C	white-brown	C011-70	GHC0110003R0001		0.02 (0.044)
80 °C	white-white	C011-80	GHC0110003R0002		0.02 (0.044)
90 °C	green-green	C011-90	GHC0110003R0003		0.02 (0.044)
100 °C	red-red	C011-100	GHC0110003R0004		0.02 (0.044)
110 °C	brown-brown	C011-110	GHC0110003R0005		0.02 (0.044)
120 °C	gray-gray	C011-120	GHC0110003R0006		0.02 (0.044)
130 °C	blue-blue	C011-130	GHC0110003R0007		0.02 (0.044)
140 °C	white-blue	C011-140	GHC0110003R0011		0.02 (0.044)
150 °C	black-black	C011-150	GHC0110003R0008		0.02 (0.044)
160 °C	blue-red	C011-160	GHC0110003R0009		0.02 (0.044)
170 °C	white-green	C011-170	GHC0110003R0010		0.02 (0.044)
Triple temperature sensor C011-3					
150 °C	black-black	C011-3-150	GHC0110033R0008		0.05 (0.11)

Technical data

Characteristic data	Sensor type C011
Cold-state resistance	50 -100 Ω at 25 °C
Warm-state resistance ± 5 up to 6 K of rated response temperature T_{NF}	10 000 Ω
Thermal time constant, sensor open ¹⁾	< 5 s
Permitted ambient temperature	+180 °C

Rated response temperature \pm tolerance $T_{NF} \pm \Delta T_{NF}$	PTC resistance R from -20 °C to T_{NF} - 20 K	PTC resistance R ²⁾ at PTC temperatures of:			
		$T_{NF} - \Delta T_{NF}$ (UPTC ≤ 2.5 V)	$T_{NF} + \Delta T_{NF}$ (UPTC ≤ 2.5 V)	$T_{NF} + 15$ K (UPTC ≤ 7.5 V)	
70 ± 5 °C	$\leq 100 \Omega$	$\leq 570 \Omega$	$\geq 570 \Omega$	-	
80 ± 5 °C					
90 ± 5 °C					
100 ± 5 °C					
110 ± 5 °C					
120 ± 5 °C					
130 ± 5 °C			$\leq 550 \Omega$	$\geq 1330 \Omega$	$\geq 4000 \Omega$
140 ± 5 °C					
150 ± 5 °C					
160 ± 5 °C					
170 ± 7 °C		$\leq 570 \Omega$	$\geq 570 \Omega$	-	

¹⁾ Not embedded in windings.

²⁾ For triple temperature sensor take values x 3.

Thermistor motor protection relays

Technical data - CM-MSS

Technical data

Data at $T_a = 25\text{ °C}$ and rated values, unless otherwise indicated

Supply circuit - Input circuit		CM-MSS.x1	CM-MSS.x2	CM-MSS.x3
Rated control supply voltage U_s	A1-A2	24-240 V AC/DC	24 V AC/DC	220-240 V AC
	A2-A3	-	-	110-130 V AC
Rated control supply voltage U_s tolerance		-15...+10 %		
Rated frequency		15-400 Hz	50-60 Hz	
Electrical insulation between supply circuit and measuring circuit		yes	no	yes
Power failure buffering time		20 ms		
Supply circuit - Measuring circuit / Sensor circuit				
Number of circuits		1 (CM-MSS.51: 2)		
Sensor type		PTC type A (DIN/EN 44081, DIN/EN 44082)		
Max. total resistance of sensors connected in series, cold state		< 750 Ω		
Overtemperature monitoring	switch-off resistance (relay de-energizes)	2.83 k Ω \pm 1% (CM-MSS.12 /13 /22 /23: 2.7 k Ω \pm 5%)		
	switch-on resistance (relay energizes)	1.1 k Ω \pm 1% (CM-MSS.12 /13 /22 /23: 1.2 k Ω \pm 5%)		
Maximum voltage in sensor circuit	1.33 k Ω	2.5 V		
	4 k Ω	3.7 V		
	∞ k Ω	5.5 V		
Maximum current in sensor circuit		3.7 mA		
Maximum sensor cable length		2 x 100 m at 0.75 mm ² , 2 x 400 m at 2.5 mm ²		
Accuracy within the rated control supply voltage tolerance		0.50 % (CM-MSS.12 /13 /22 /23: 5 %)		
Accuracy within the temperature range		0.01 %/K (CM-MSS.12 /13 /22 /23: 0.5 %/K)		
Repeat accuracy (constant parameters)		on request		
Reaction time of the safety function		< 100 ms		
Hardware fault tolerance (HFT)		0		
Control circuit				
Control function		see "Selection table - Thermistor motor protection relays" on page 2/73		
Maximum no-load voltage		5.5 V		
Max. current		0.6 mA (CM-MSS.12 /13 /22 /23: 1.2 mA)		
Maximum cable length		2 x 100 m at 0.75 mm ² , 2 x 400 m at 2.5 mm ²		
Indication of operational states				
Control supply voltage	U	LED green		
Relay status	R	LED yellow		
Fault message	F	LED red		
Output circuit				
Kind of output		see "Selection table - Thermistor motor protection relays" on page 2/73		
Operating principle		closed-circuit principle		
Contact material		AgNi alloy, Cd free		
Minimum switching voltage / Minimum switching current		24 V / 10 mA		
Maximum switching voltage / Maximum switching current		see data sheet		
Rated operational voltage U_o and rated operational current I_o	AC-12 (resistive) at 230 V	4 A		
	AC-15 (inductive) at 230 V	3 A		
	DC-12 (resistive) at 24 V	4 A		
	DC-13 (inductive) at 24 V	2 A		
AC Rating (UL 508)	utilization category (Control Circuit Rating Code)	B 300		
	maximum rated operational voltage	300 V AC		
	maximum continuous thermal current at B 300	5 A		
	maximum making/breaking apparent power at B 300	3600/360 VA		
	general purpose rating	250 V AC - 4 A		
Mechanical lifetime		30 x 10 ⁶ switching cycles		
Electrical lifetime	at AC-12, 230 V AC, 4 A	0.1 x 10 ⁶ switching cycles		
Maximum fuse rating to achieve short-circuit protection	n/c contact	10 A fast-acting (CM-MSS.12, CM-MSS.13, CM-MSS.51: 6 A)		
	n/o contact	10 A fast-acting		

Thermistor motor protection relays

Technical data - CM-MSS

2

General data			
MTBF		on request	
Duty cycle		100 %	
Dimensions		see 'Dimensional drawings'	
Mounting		DIN rail (IEC/EN 60715), snap-on mounting without any tool	
Mounting position		any	
Minimum distance to other units	vertical / horizontal	10 mm (0.39 in) if switching current > 2 A	
Material of housing		UL 94 V-0	
Degree of protection	housing	IP50	
	terminals	IP20	
Electrical connection		Screw connection technology	Easy Connect Technology (push-in)
Connection capacity	fine-strand with(out) wire end ferrule	1 x 0.5-2.5 mm ² (1 x 18-14 AWG) 2 x 0.5-1.5 mm ² (2 x 18-16 AWG)	2 x 0.5-1.5 mm ² (2 x 18-16 AWG)
	rigid	1 x 0.5-4 mm ² (1 x 20-12 AWG) 2 x 0.5-2.5 mm ² (2 x 20-14 AWG)	2 x 0.5-1.5 mm ² (2 x 20-16 AWG)
Stripping length		8 mm (0.32 in)	
Tightening torque		0.6-0.8 Nm (7.08 lb.in)	-
Environmental data			
Ambient temperature ranges	operation	-25...+60 °C (-13...+140 °F)	
	storage	-40...+85 °C (-40...+185 °F)	
Damp heat, cyclic (IEC/EN 60068-2-30)		6 x 24 h cycle, 55 °C, 95 % RH	
Climatic class (IEC/EN 60721-3-3)		3K5 (no condensation, no ice formation)	
Vibration, sinusoidal		5-13.2 Hz: ±1 mm; 13.2-100 Hz: 0.7 g	
Shock		10 g / 11 ms	
Isolation data			
Rated insulation voltage U _i	supply circuit / measuring circuit ¹⁾	300 V AC (CM-MSS.x2: n/a)	
	supply circuit / output circuits	300 V AC	
	measuring circuit ¹⁾ / output circuits	300 V AC	
	output circuit 1 / output circuit 2	300 V AC	
Rated impulse withstand voltage U _{imp}	supply circuit / measuring circuit ¹⁾	4 kV (CM-MSS.x2: n/a)	
	supply circuit / output circuits	4 kV	
	measuring circuit ¹⁾ / output circuits	4 kV	
	output circuit 1 / output circuit 2	4 kV	
Basic insulation	supply circuit / measuring circuit ¹⁾	600 V AC (CM-MSS.x2: n/a)	
	supply circuit / output circuits	600 V AC	
	measuring circuit ¹⁾ / output circuits	600 V AC	
	output circuit 1 / output circuit 2	300 V AC	
Protective separation (IEC/EN 61140, EN 50178)	supply circuit / measuring circuit ¹⁾	yes, up to 300 V	
	supply circuit / output circuits	yes (CM-MSS.x2: n/a)	
	measuring circuit ¹⁾ / output circuits	yes	
	output circuit 1 / output circuit 2	no	
Pollution degree		3	
Overvoltage category		III	
Standards / Directives			
Standards		IEC/EN 60947-5-1, IEC/EN 60947-8	
Low Voltage Directive		2014/35/EU	
EMC directive		2014/30/EU	
ATEX directive		2014/34/EC (only ATEX variants, "Selection table - Thermistor motor protection relays" on page 2/73)	
RoHS directive		2011/65/EU	

¹⁾ Potential of measuring circuit = Potential of control circuit

Thermistor motor protection relays

Technical data - CM-MSS

Electromagnetic compatibility

Interference immunity to		IEC/EN 61000-6-2, IEC/EN 60947-8
electrostatic discharge	IEC/EN 61000-4-2	level 3, 6 kV contact discharge, 8 kV air discharge
radiated, radio-frequency, electromagnetic field	IEC/EN 61000-4-3	level 3, 10 V/m (1 GHz), 3 V/m (2 GHz), 1 V/m (2.7 GHz)
electrical fast transient / burst	IEC/EN 61000-4-4	level 3, 2 kV / 5 kHz
surge	IEC/EN 61000-4-5	level 3, installation class 3, supply circuit and measuring circuit 1 kV L-L, 2 kV L-N
conducted disturbances, induced by radio-frequency fields	IEC/EN 61000-4-6	level 3, 0.15-80 MHz, 10 V, 80 % AM (1kHz)
voltage dips, short interruptions and voltage variations	IEC/EN 61000-4-11	class 3
harmonics and interharmonics	IEC/EN 61000-4-13	class 3
Additional interference immunity according to product standard IEC/EN 60255-1 (reference on IEC/EN 60255-26)		
radiated, radio-frequency, electromagnetic field	IEC/EN 61000-4-3	10 V/m (80 MHz - 3 GHz)
conducted disturbances, induced by radio-frequency fields	IEC/EN 61000-4-6	10 V at stated frequencies
damped oscillatory waves	IEC/EN 61000-4-18	signal lines, symmetric coupling: 1 kV peak voltage power supply, asymmetric coupling: 2.5 kV peak voltage
Interference emissions		IEC/EN 61000-6-3
high-frequency radiated	IEC/CISPR 22, EN 55022	class B
high-frequency conducted	IEC/CISPR 22, EN 55022	class B
high-frequency radiated	Germanischer Lloyd	increased requirements in the emergency call frequency band

Thermistor motor protection relays

Technical data - CM-MSE

Technical data

Data at $T_a = 25\text{ °C}$ and rated values, unless otherwise indicated

Supply circuit - Input circuit		CM-MSE
Rated control supply voltage U_s power consumption	1SVR550805R9300	24 V AC approx. 1.5 A
	1SVR550800R9300	110-130 V AC approx. 1.5 A
	1SVR550801R9300	220-240 V AC approx. 1.5 A
Rated control supply voltage U_s tolerance		-15...+10 %
Rated frequency		50-60 Hz
Measuring circuit		
Monitoring function	T1-T2	temperature monitoring by means of PTC sensors
Number of sensor circuits		1
Sensor circuit		
Sensor type		PTC type A (DIN/EN 44081, DIN/EN 44082)
Max. total resistance of sensors connected in series, cold state		$\leq 1.0\text{ k}\Omega$
Overtemperature monitoring	switch-off resistance (relay de-energizes)	2.0-3.0 $\text{k}\Omega$
	switch-on resistance (relay energizes)	1.2-1.65 $\text{k}\Omega$
Maximum voltage in sensor circuit	4 $\text{k}\Omega$	5 V
	$\infty\text{ k}\Omega$	15 V
Maximum current in sensor circuit		2 mA
Maximum sensor cable length		2 x 100 m at 0.75 mm ² , 2 x 400 m at 2.5 mm ²
Reaction time		<100 ms
Output circuit		
Kind of output	13-14	1 n/o contact
Operational principle		closed-circuit principle (output relay de-energizes if the measured value exceeds/drops below the adjusted threshold)
Maximum switching voltage		250 V
Rated operational voltage U_e and rated operational current I_e	AC-12 (resistive) at 230 V	4 A
	AC-15 (inductive) at 230 V	3 A
	DC-12 (resistive) at 24 V	4 A
	DC-13 (inductive) at 24 V	2 A
AC Rating (UL 508)	utilization category (Control Circuit Rating Code)	B 300
	maximum rated operational voltage	300 V AC
	maximum continuous thermal current at B 300	5 A
	maximum making/breaking apparent power at B 300	3600/360 VA
	general purpose rating	250 V AC - 4 A
Mechanical lifetime		30 x 10 ⁶ switching cycles
Electrical lifetime	at AC-12, 230 V AC, 4 A	0.1 x 10 ⁶ switching cycles
Maximum fuse rating to achieve short-circuit protection	n/c contact	10 A fast-acting
	n/o contact	10 A fast-acting
General data		
Dimensions		see 'Dimensional drawings'
Duty cycle		100 %
Mounting		DIN rail (IEC/EN 60715)
Mounting position		any
Degree of protection	housing / terminals	IP50 / IP20
Electrical connection		
Connecting capacity	fine strand with wire end ferrule	2 x 1.5 mm ² (2 x 16 AWG)
	fine strand without wire end ferrule	2 x 0.75-1.5 mm ² (2 x 18-16 AWG)
	rigid	2 x 1-1.5 mm ² (2 x 18-16 AWG)
Stripping length		2 x 0.75-1.5 mm ² (2 x 18-16 AWG)
Tightening torque		0.6-0.8 Nm (5.31-7.08 lb.in)
Environmental data		
Ambient temperature ranges	operation	-20...+60 °C
	storage	-40...+85 °C
Damp heat	IEC/EN 60068-2-30	40 °C, 93 % RH, 4 days
Vibration withstand	IEC/EN 60068-2-6	10-57 Hz: 0.075 mm; 57-150 Hz: 1 g

Thermistor motor protection relays

Technical data - CM-MSE

Isolation data

Rated insulation voltage U _i	supply, measuring / output circuit	250 V
Rated impulse withstand voltage U _{imp}	between all isolated circuits	4 kV / 1.2 - 50 μs
Pollution degree		3
Overvoltage category		III

Standards / Directives

Standards	IEC/EN 60947-5-1, IEC/EN 60947-8	
Low Voltage Directive	2014/35/EU	
EMC Directive	2014/30/EU	
RoHS directive	2011/65/EU	

Electromagnetic compatibility

Interference immunity to		IEC/EN 61000-6-2, IEC/EN 60947-8
electrostatic discharge	IEC/EN 61000-4-2	level 3, 6 kV contact discharge, 8 kV air discharge
radiated, radio-frequency, electromagnetic field	IEC/EN 61000-4-3	level 3, 10 V/m (1 GHz), 3 V/m (2 GHz), 1 V/m (2.7 GHz)
electrical fast transient /burst	IEC/EN 61000-4-4	level 3, 2 kV / 5 kHz
surge	IEC/EN 61000-4-5	level 3, installation class 3, supply circuit and measuring circuit 1 kV L-L, 2 kV L-N
conducted disturbances, induced by radio-frequency fields	IEC/EN 61000-4-6	level 3, 0.15-80 MHz, 10 V, 80 % AM (1kHz)
Interference emission		IEC/EN 61000-6-3
high-frequency radiated	IEC/CISPR 22, EN 55022	class B
high-frequency conducted	IEC/CISPR 22, EN 55022	class B

Thermistor motor protection relays

Connection diagrams

2

CM-MSS.11, CM-MSS.21

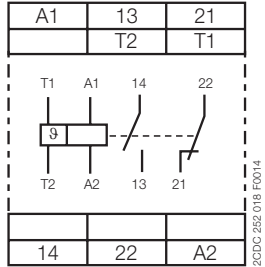

- A1 – A2 Control supply voltage
- 13 – 14 n/o contact
- 21 – 22 n/c contact
- T1 – T2 Measuring circuit

CM-MSS.12

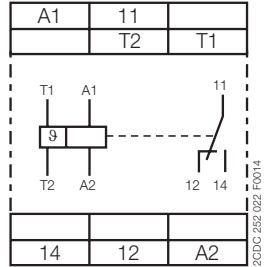

- A1 – A2 Control supply voltage
- 11 – 12/14 c/o contact
- T1 – T2 Measuring circuit

CM-MSS.13

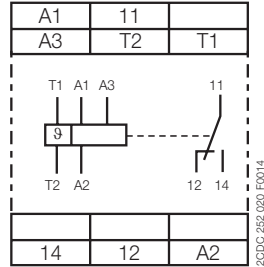

- A1 – A2 Control supply voltage 220-240 V AC
- A2 – A3 Control supply voltage 110-130 V AC
- 11 – 12/14 c/o contact
- T1 – T2 Measuring circuit

CM-MSS.31

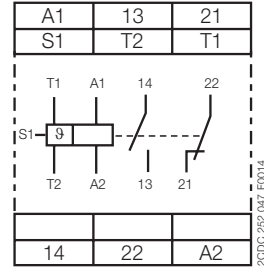

- A1 – A2 Control supply voltage
- 13 – 14 n/o contact
- 21 – 22 n/c contact
- S1 – T2 Automatic reset (jumpered)
- T1 – T2 Measuring circuit

CM-MSS.22, CM-MSS.32, CM-MSS.41

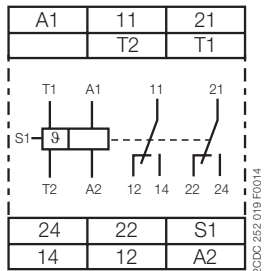

- A1 – A2 Control supply voltage 24 V AC/DC
- 11 – 12/14 1st c/o (SPDT) contact
- 21 – 22/24 2nd c/o (SPDT) contact
- S1 – T2 Automatic reset (jumpered)
- T1 – T2 Measuring circuit

CM-MSS.23, CM-MSS.33

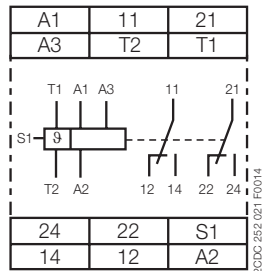

- A1 – A2 Control supply voltage 220-240 V AC
- A2 – A3 Control supply voltage 110-130 V AC
- 11 – 12/14 1st c/o (SPDT) contact
- 21 – 22/24 2nd c/o (SPDT) contact
- S1 – T2 Automatic reset (jumpered)
- T1 – T2 Measuring circuit

CM-MSS.51

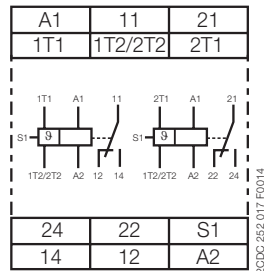

- A1 – A2 Control supply voltage 220-240 V AC
- 11 – 12/14 1st c/o (SPDT) contact
- 21 – 22/24 2nd c/o (SPDT) contact
- S1 – 1T2/2T2 Automatic reset (jumpered)
- 1T1 – 1T2/2T2 Measuring circuit 1
- 2T1 – 1T2/2T2 Measuring circuit 2

CM-MSE

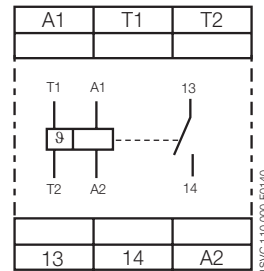

- A1 – A2 Control supply voltage 24 V AC
- T1-T2 Sensor circuit
- 13-14 Output contact - Closed circuit principle

Thermistor motor protection relays

Circuit diagrams

CM-MSS.11, CM-MSS.21

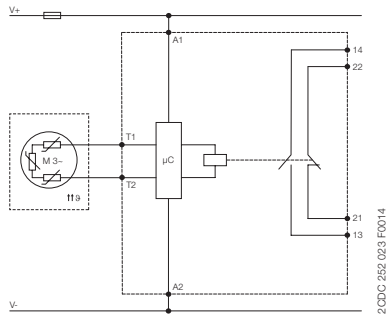

CM-MSS.12

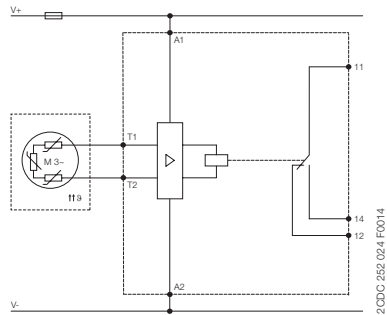

CM-MSS.13

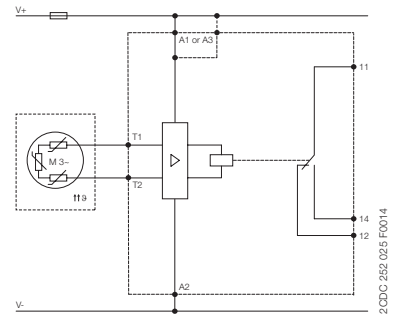

CM-MSS.22

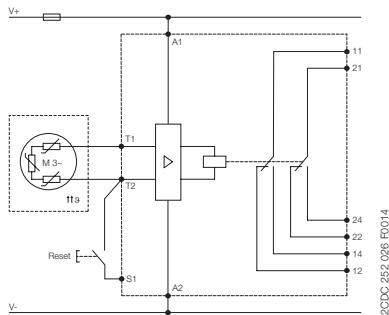

CM-MSS.23

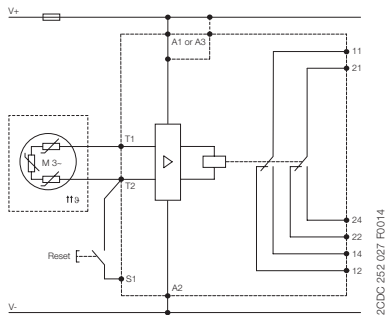

CM-MSS.31

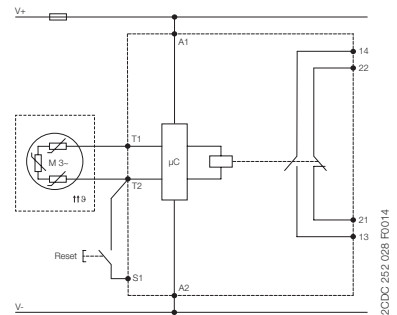

CM-MSS.32, CM-MSS.41

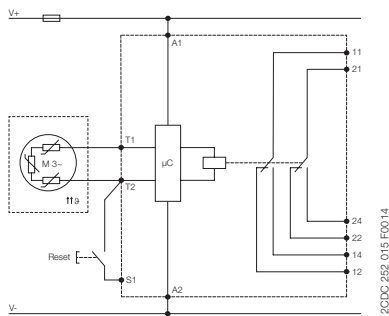

CM-MSS.33

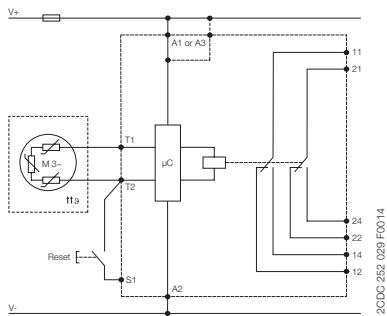

CM-MSS.51

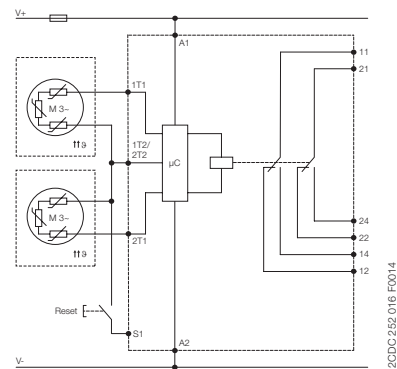

CM-MSE

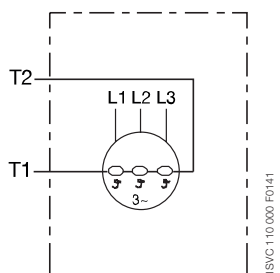

Temperature monitoring relays

Product group picture

2



Temperature monitoring relays

Table of contents

Temperature monitoring relays

Benefits and advantages, Operating controls	2/85
Selection table - Temperatur monitoring relays	2/86
Ordering details	2/87
Function diagrams	2/88
Function diagrams and DIP switches	2/89
Connection diagram, Resistance thermometer sensors	2/90
Technical data - CM-TCS	2/91

Temperature monitoring relays

Benefits and advantages, Operating controls

Overview

The temperature monitoring relays can be used for temperature measurement in solid, liquid and gaseous media. The temperature is acquired by the sensor in the medium, evaluated by the device and monitored to determine whether it is within an operating range (range monitoring function) or has exceeded or fallen below a threshold.

Functional description

The temperature monitoring relays CM-TCS monitor overtemperature, undertemperature, or temperatures between two threshold values (window monitoring) with PT100 sensor. As soon as the temperature falls below or exceeds the threshold value the output relays change their positions according to the configured functionality and the front-face LEDs display the current status. Regardless of the selected configuration, the device is monitoring its measuring circuit for interrupted wires or short-circuits.

Characteristics

- Adjustable sensor type PT100
- Functionality like overtemperature monitoring, undertemperature monitoring, temperature window monitoring configurable
- All configurations and adjustments by front-face operating elements
- Precise adjustment with direct reading scales
- One or two threshold values
- Hysteresis 2...20 % adjustable
- Operating temperature range -40...+60 °C
- 1 x 2 c/o or 2 x 1 c/o configurable
- Open- or closed-circuit principle configurable
- Short-circuit monitoring and interrupted wire detection
- 22.5 mm (0.89 in) width
- LEDs for status indication
- Various approvals and marks

Operating controls

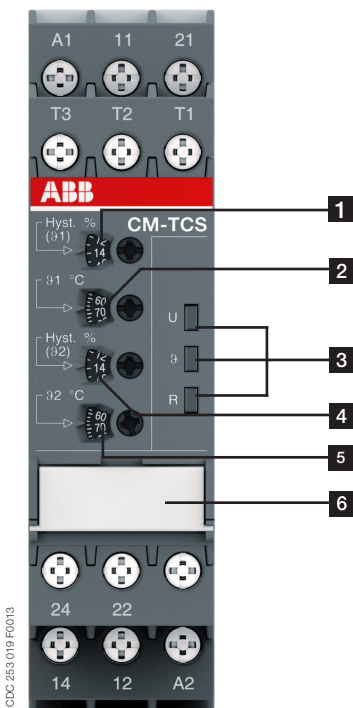

1 Adjustment of the hysteresis for threshold value θ1

2 Adjustment of the threshold value θ1

3 Indication of operational states

U: green LED – status indication of control supply voltage

θ: red LED – fault message, state of measuring input

R: yellow LED – status indication of the output relays

4 Adjustment of the hysteresis for threshold value θ2

5 Adjustment of the threshold value θ2

6 DIP switch functions / marker label (on page 2/104)

Overtemperature monitoring

Undertemperature monitoring

Temperature window monitoring activated

Temperature window monitoring de-activated

Closed-circuit principle

Open-circuit principle

2 x 1 c/o (SPDT) contact

1 x 2 c/o (SPDT) contacts

Temperature monitoring relays

Selection table - Temperatur monitoring relays

	Type	Order number											
	CM-TCS.21S	1SVR 730 740 R9100											
	CM-TCS.21P	1SVR 740 740 R9100											
	CM-TCS.11S	1SVR 730 740 R0100											
	CM-TCS.11P	1SVR 740 740 R0100											
	CM-TCS.22S	1SVR 730 740 R9200											
	CM-TCS.22P	1SVR 740 740 R9200											
	CM-TCS.12S	1SVR 730 740 R0200											
	CM-TCS.12P	1SVR 740 740 R0200											
	CM-TCS.23S	1SVR 730 740 R9300											
	CM-TCS.23P	1SVR 740 740 R9300											
	CM-TCS.13S	1SVR 730 740 R0300											
	CM-TCS.13P	1SVR 740 740 R0300											
Rated control supply voltage U_g													
24 V AC/DC			■	■			■	■			■	■	
24-240 V AC/DC					■	■			■	■			■
Sensor circuits (2 or 3 wire)													
Number of temperature sensors			1	1	1	1	1	1	1	1	1	1	1
Number of thresholds			2	2	2	2	2	2	2	2	2	2	2
Measuring temperature range													
-50...+50 °C			■	■	■	■							
0...+100 °C							■	■	■				
0...+200 °C										■	■	■	■
Monitoring function													
Overtemperature			■	■	■	■	■	■	■	■	■	■	■
Undertemperature			■	■	■	■	■	■	■	■	■	■	■
Window temperature			■	■	■	■	■	■	■	■	■	■	■
Operating principle													
Open- or closed-circuit principle			■	■	■	■	■	■	■	■	■	■	■
Output contacts													
c/o			2	2	2	2	2	2	2	2	2	2	2

Temperature monitoring relays

Ordering details

2



CM-TCS

Description

The temperature monitoring relays CM-TCS are able to measure temperatures of solids, liquids and gaseous media using different types of sensors. Overtemperature and undertemperature monitoring as well as open- or closed-circuit principle is configurable for all devices. As soon as the temperature falls below or exceeds the set threshold value the output relays change their positions according to the configured functionality and the front-face LEDs display the current status.

Ordering details - Temperature monitoring relays CM-TCS

Rated control supply voltage	Measuring range	Temperature sensors	Type	Order code	Price	Weight
					1 pc	(1 pc) kg (lb)
24-240 V AC/DC	-50...+50 °C	PT100	CM-TCS.11S	1SVR730740R0100		0.151 (0.333)
			CM-TCS.11P	1SVR740740R0100		0.140 (0.309)
	0...+100 °C		CM-TCS.12S	1SVR730740R0200		0.151 (0.333)
			CM-TCS.12P	1SVR740740R0200		0.140 (0.309)
	0...+200 °C		CM-TCS.13S	1SVR730740R0300		0.151 (0.333)
			CM-TCS.13P	1SVR740740R0300		0.140 (0.309)
24 V AC/DC	-50...+50 °C		CM-TCS.21S	1SVR730740R9100		0.138 (0.304)
			CM-TCS.21P	1SVR740740R9100		0.127 (0.280)
	0...+100 °C		CM-TCS.22S	1SVR730740R9200		0.138 (0.304)
			CM-TCS.22P	1SVR740740R9200		0.127 (0.280)
	0...+200 °C		CM-TCS.23S	1SVR730740R9300		0.138 (0.304)
			CM-TCS.23P	1SVR740740R9300		0.127 (0.280)

S: screw connection
P: push-in connection



Further documentation temperature monitoring relays on www.abb.com

Temperature monitoring relays

Function diagrams

Overtemperature monitoring, 1 x 2 c/o contacts 1x2 c/o

With this configuration, settings via $\vartheta 2$ have no influence on the operating function ($\vartheta 2$ disabled).

Open-circuit principle:

If the measured value is correct, the output relays remain de-energized when control supply voltage is applied. If the measured value exceeds the adjusted threshold value $\vartheta 1$, the output relays energize. If the measured value drops again below the adjusted threshold value $\vartheta 1$ minus the adjusted hysteresis, the output relays de-energize.

Closed-circuit principle:

The behavior is inverse to the one with open-circuit principle.

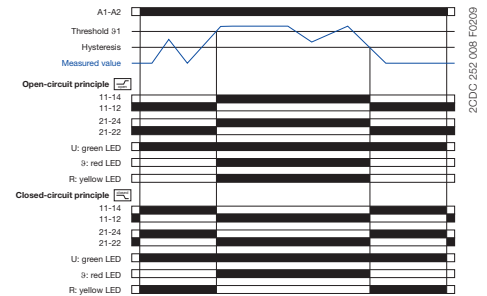

2CDC 252 008 F0209

Overtemperature monitoring, 2 x 1 c/o contact 2x1 c/o

Open-circuit principle:

If the measured value is correct, the output relays remain de-energized when control supply voltage is applied. If the measured value exceeds the adjusted threshold value $\vartheta 2$, output relay R2 (prewarning) energizes. If the measured value exceeds the adjusted threshold value $\vartheta 1$, output relay R1 (final switch-off) energizes.

If the measured value drops again below the adjusted threshold value $\vartheta 1$ minus the adjusted hysteresis, output relay R1 (final switch-off) de-energizes. If the measured value drops below the adjusted threshold value $\vartheta 2$ minus the adjusted hysteresis, output relay R2 (prewarning) de-energizes.

Closed-circuit principle:

The behavior is inverse to the one with open-circuit principle.

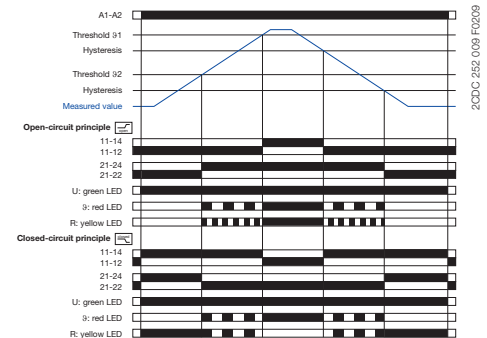

2CDC 252 009 F0209

Undertemperature monitoring, 1 x 2 c/o contacts 1x2 c/o

With this configuration, settings via $\vartheta 1$ have no influence on the operating function ($\vartheta 1$ disabled).

Open-circuit principle:

If the measured value is correct, the output relays remain de-energized when control supply voltage is applied. If the measured value drops below the adjusted threshold value $\vartheta 2$, the output relays energize. If the measured value exceeds again the adjusted threshold value $\vartheta 2$ plus the adjusted hysteresis, the output relays de-energize.

Closed-circuit principle:

The behavior is inverse to the one with open-circuit principle.

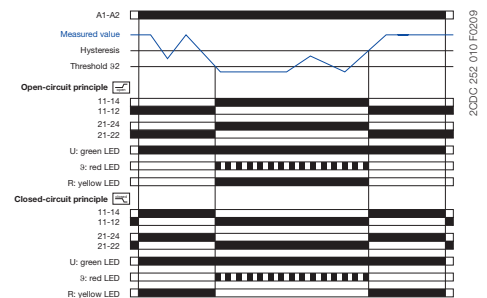

2CDC 252 010 F0209

Undertemperature monitoring, 2 x 1 c/o contact 2x1 c/o

Open-circuit principle:

If the measured value is correct, the output relays remain de-energized when control supply voltage is applied. If the measured value drops below the adjusted threshold value $\vartheta 1$, output relay R1 (prewarning) energizes. If the measured value drops below the adjusted threshold value $\vartheta 2$, output relay R2 (final switch-off) energizes.

If the measured value exceeds again the adjusted threshold value $\vartheta 2$ plus the adjusted hysteresis, output relay R2 (final switch-off) de-energizes. If the measured value exceeds the adjusted threshold value $\vartheta 1$ plus the adjusted hysteresis, output relay R1 (prewarning) de-energizes.

Closed-circuit principle:

The behavior is inverse to the one with open-circuit principle.

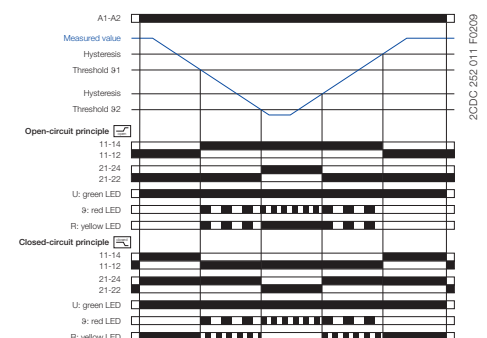

2CDC 252 011 F0209

Temperature monitoring relays

Function diagrams and DIP switches

2

Temperature window monitoring, 1 x 2 c/o contacts

Open-circuit principle:

If the measured value is correct, the output relays remain de-energized when control supply voltage is applied. If the measured value exceeds the adjusted threshold value ϑ_1 or drops below the adjusted threshold value ϑ_2 , the output relays energize. If the measured value drops again below the adjusted threshold value ϑ_1 minus the adjusted hysteresis or exceeds again the adjusted threshold value ϑ_2 plus the adjusted hysteresis, the output relays de-energize.

Closed-circuit principle:

The behavior is inverse to the one with open-circuit principle.

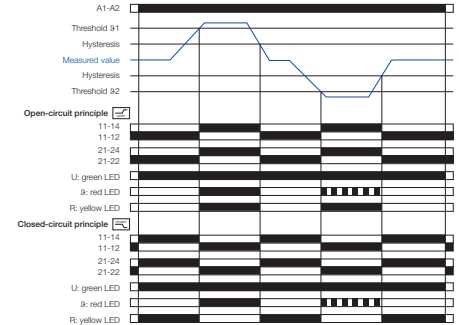

2CDC 252 012 F0209

Temperature window monitoring, 2 x 1 c/o contact

Open-circuit principle:

If the measured value is correct, the output relays remain de-energized when control supply voltage is applied.

If the measured value exceeds the adjusted threshold value ϑ_1 or drops below the adjusted threshold value ϑ_2 , output relay R1 ($> \vartheta_1$) or R2 ($< \vartheta_2$) respectively energizes.

If the measured value drops again below the adjusted threshold value ϑ_1 minus the adjusted hysteresis or exceeds again the adjusted threshold value ϑ_2 plus the adjusted hysteresis, output relay R1 ($> \vartheta_1$) or R2 ($< \vartheta_2$) respectively de-energizes.





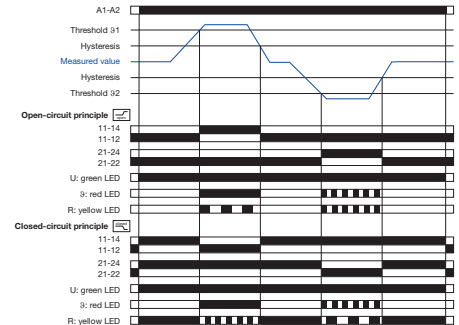



Closed-circuit principle:









The behavior is inverse to the one with open-circuit principle.



2CDC 252 013 F0209

DIP switches CM-TCS

Position	4	3	2	1
ON ↑				
OFF				

	ON	OFF (default)
DIP switch 1 Monitoring principle	Overtemperature monitoring  If overtemperature monitoring is selected, the CM-TCS recognizes temperatures above the selected threshold and trips the output relay according to the selected operating principle.	Undertemperature monitoring  If undertemperature monitoring is selected, the CM-TCS recognizes temperatures below the selected threshold and trips the output relay according to the selected operating principle.
DIP switch 2 Temperature window monitoring	Temperature window monitoring activated  If temperature window monitoring is selected, the CM-TCS monitors over- and undertemperature. If temperature window monitoring is activated, DIP switch 1 is disabled.	Temperature window monitoring de-activated  Temperature window monitoring is de-selected.
DIP switch 3 Operating principle of the output relays	Closed-circuit principle  If closed-circuit principle is selected, the output relays are energized. They de-energize if a fault is occurring.	Open-circuit principle  If open-circuit principle is selected, the output relays are deenergized. They energize if a fault is occurring.
DIP switch 4 2 x 1 c/o contact, 1 x 2 c/o contacts	2 x 1 c/o (SPDT) contact  If operating principle 2 x 1 c/o contact is selected, the output relay R1 (11-12/14) reacts to threshold value ϑ_1 and the output relay R2 (21-22/24) reacts to threshold value ϑ_2 .	1 x 2 c/o (SPDT) contacts  If operating principle 1 x 2 c/o contacts is selected, both output relays R1 (11-12/14) and R2 (21-22/24) react synchronously to one threshold value. Overtemperature monitoring: Settings of the threshold value ϑ_2 have no effect on the operation. Undertemperature monitoring: Settings of the threshold values ϑ_2 have no effect on the operation.

Temperature monitoring relays

Connection diagram, Resistance thermometer sensors

Connection diagram

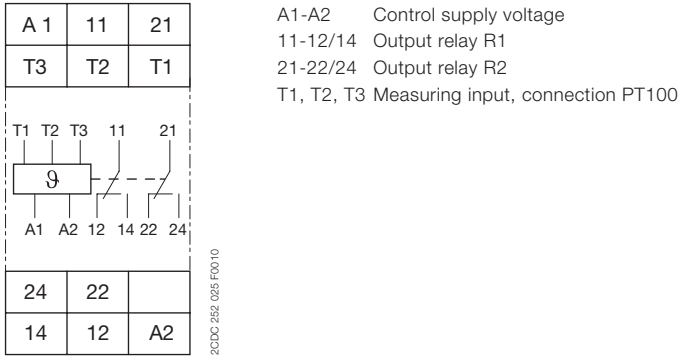

Connection of resistance thermometer sensors

2-wire measurement

When using 2-wire temperature sensors the sensor resistance and the wire resistance are added together. The resulting systematic errors must be taken into account when adjusting the tripping device. A jumper must be connected between the terminals T2 and T3. The following table can be used for PT100 sensors to determine the temperature errors caused by the line length.

When using resistance sensors with two-wire connection a bridge must be inserted between terminals T2 and T3.

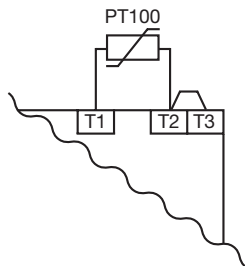

3-wire measurement

To minimize the influence of the wire resistance, a three-wire connection is usually used. By means of the additional wire two measuring circuits are created. One of these two circuits is used for reference. This way, the tripping device can calculate and take into account the wire resistance automatically.

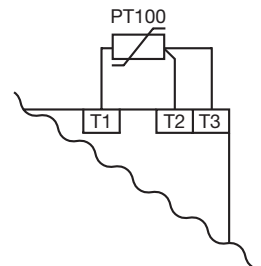

Error caused by the line

The error resulting from the line resistance amounts to approx. 2.5 Kelvin/Ohm. If the resistance of the line is not known and it is not possible to measure it, the error caused by the line can be estimated using the following table.

Temperature error

(depending on the line length and conductor cross section for PT100 sensors at an ambient temperature of 20 °C, in K)

Line length in m	Wire size mm ²			
	0.50	0.75	1	1.5
0	0.0	0.0	0.0	0.0
10	1.8	1.2	0.9	0.6
25	4.5	3.0	2.3	1.5
50	9.0	6.0	4.5	3.0
75	13.6	9.0	6.8	4.5
100	18.1	12.1	9.0	6.0
200	36.3	24.2	18.1	12.1
500	91.6	60.8	45.5	30.2

Electrical isolation

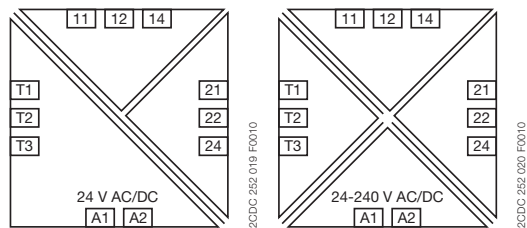

- Electrical isolation
- Protective separation acc. to IEC/EN 61140, EN 50178

Temperature monitoring relays

Technical data - CM-TCS

2

Type		CM-TCS.11/12/13	CM-TCS.21/22/23
Input circuit			
Rated control supply voltage U_c	A1-A2	24-240 V AC/DC	24 V AC/DC
Rated control supply voltage U_c tolerance		-15...+10 %	
Typical current / power / consumption	24 V DC	33 mA / 0.8 VA	18 mA / 0.45 VA
	115 V AC	12.5 mA / 1.5 VA	n/a
	230 V AC	13 mA / 2.9 VA	n/a
Rated frequency	AC	15-400 Hz	50/60 Hz
Frequency range	AC	13.5-440 Hz	45-65 Hz
Power failure buffering time	min.	20 ms	
Measuring circuit		T1, T2, T3	
Sensor type		PT100	
Connection of the sensor	2-wire	yes, jumper between T2-T3	
	3-wire	yes, use terminal T1, T2, T3	
Monitoring function		overtemperature, undertemperature or window monitoring	
Threshold values adjustable within the measuring range	CM-TCS.x1	-50...+50 °C	
	CM-TCS.x2	0...+100 °C	
	CM-TCS.x3	0...+200 °C	
Number of possible thresholds		2	
Tolerance of the adjusted threshold value		typ. ± 5 % of the range end value	
Hysteresis related to the threshold value		2-20 % of threshold value, min. 1 °C	
Measuring principle		continuous current	
Typical current in the sensor circuit		0.8 mA	
Maximum current in sensor circuit		0.9 mA	
Interrupted wire detection		yes, indicated via LED status	
Short-circuit detection		yes, indicated via LED status	
Accuracy within the rated control supply voltage tolerance		< 0.2 °C / or < 0.01 %/K	
Accuracy within the temperature range		< 0.2 °C / or < 0.01 %/K	
Repeat accuracy (constant parameters)		< 0.2 % of full scale	
Maximum measuring cycle		320 ms	
Output circuit			
Kind of output		2 x 1 or 1 x 2 c/o (SPDT) contacts configurable	
Operating principle		open- or closed-circuit principle configurable ¹⁾	
Contact material		AgNi alloy, Cd free	
Minimum switching voltage / Minimum switching current		24 V / 10 mA	
Maximum switching voltage / Maximum switching current		see 'Load limit curves'	
Rated operational voltage U_e and rated operational current I_e	AC-12 (resistive) 230 V	4 A	
	AC-15 (inductive 230 V	3 A	
	DC-12 (resistive) 24 V	4 A	
	DC-13 (inductive) 24 V	2 A	
AC Rating (UL508)	utilization category	B 300 pilot duty; general purpose 250 V, 4 A, $\cos \varphi$ 0.75	
	maximum rated operational voltage	250 V AC	
	maximum continuous thermal current at B 300	4 A	
	maximum making/breaking apparent power at B.300	3600/360 VA	
Mechanical lifetime		30 x 10 ⁶ switching cycles	
Electrical lifetime (AC-12, 230 V, 4 A)		0.1 x 10 ⁶ switching cycles	
Maximum fuse rating to achieve short-circuit protection	n/c contact	6 A fast-acting	
	n/o contact	10 A fast-acting	
Conventional thermal current I_{th}		4 A	
General data			
Dimensions		see 'Dimensional drawings'	
Mounting		DIN rail (IEC/EN 60715), snap-on mounting without any tool	
Mounting position		any	
Ambient temperature range	operation	-40...+60 °C	
	storage/transport	-40...+85 °C	
Degree of protection	enclosure / terminals	IP50 / IP20	

¹⁾ Closed-circuit principle: Output relay(s) de-energize(s) if measured value exceeds or falls below the adjusted threshold value

Temperature monitoring relays

Technical data - CM-TCS

Type			CM-TCS.11/12/13	CM-TCS.21/22/23
Electrical connection				
Connecting capacity	fine-strand without wire end ferrule	A1, A2, 11, 12, 14, 21, 22, 24	Screw connection technology 1 x 0.5-2.5 mm ² (1 x 18-14 AWG) 2 x 0.5-1.5 mm ² (2 x 18-16 AWG)	Easy Connect Technology (Push-in) 2 x 0.5-1.5 mm ² (2 x 18-16 AWG) connection with lever
		T1, T2, T3	1 x 0.2-2.5 mm ² (1 x 24-14 AWG) 2 x 0.2-1.5 mm ² (2 x 24-16 AWG)	2 x 0.2-1.5 mm ² (2 x 24-16 AWG) connection with lever
	fine-strand with wire end ferrule	A1, A2, 11, 12, 14, 21, 22, 24	1 x 0.5-2.5 mm ² (1 x 20-14 AWG) 2 x 0.5-1.5 mm ² (2 x 20-16 AWG)	2 x 0.5-1.5 mm ² (2 x 20-16 AWG) connection: push-in
		T1, T2, T3	1 x 0.2-2.5 mm ² (1 x 24-14 AWG) 2 x 0.2-1.5 mm ² (2 x 24-16 AWG)	2 x 0.2-1.5 mm ² (2 x 24-16 AWG) insulated ferrule (DIN 46228-4-E): connection: push-in ferrule (DIN 46228-1-A): < 0.5 mm ² , connection with lever ≥ 0.5 mm ² , connection: push-in
	rigid	A1, A2, 11, 12, 14, 21, 22, 24	1 x 0.5-4 mm ² (1 x 20-12 AWG) 2 x 0.5-2.5 mm ² (2 x 20-14 AWG)	2 x 0.5-1.5 mm ² (2 x 20-16 AWG) connection: push-in
		T1, T2, T3	1 x 0.2-4 mm ² (1 x 24-12 AWG) 2 x 0.2-2.5 mm ² (2 x 24-14 AWG)	2 x 0.2-1.5 mm ² (2 x 24-16 AWG) < 0.5 mm ² , connection with lever ≥ 0.5 mm ² , connection: push-in
Stripping length			8 mm (0.32 in)	
Tightening torque	< 0.5 mm ²		0.5 Nm (4.43 lb.in)	
	≥ 0.5 mm ²		0.6-0.8 Nm (7.08 lb.in)	
Environmental data				
Ambient temperature ranges	operation/storage/ transport	-40...+60°C/-40...+85°C/-40...+85°C		
Climatic class	IEC/EN 60721-3-3	3K5 (no condensation, no ice formation)		
Damp heat, cyclic	IEC/EN 600068-2-30	6 x 24 h cycle, 55 °C, 95 % RH		
Vibration, sinusoidal		class 2		
Shock		class 2		
Isolation data				
Rated impulse withstand voltage U _{imp}	supply circuit / measuring circuit	4 kV		-
	supply circuit / output circuits	4 kV		-
	measuring circuit / output circuits	4 kV		-
	output circuit 1 / output circuit 2	4 kV		-
Rated insulation voltage U _i	supply circuit / measuring circuit	300 V		-
	supply circuit / output circuits	300 V		-
	measuring circuit / output circuits	300 V		-
	output circuit 1 / output circuit 2	300 V		-
Basic insulation	supply circuit / measuring circuit	250 V AC / 300 V DC		-
	supply circuit / output circuits	250 V AC / 300 V DC		-
	measuring circuit / output circuits	250 V AC / 300 V DC		-
	output circuit 1 / output circuit 2	250 V AC / 300 V DC		-
Protective separation (IEC/EN 61140, EN 50178)	supply circuit / measuring circuit	250 V AC / 250 V DC		-
	supply circuit / output circuits	250 V AC / 300 V DC		250 V AC / 250 V DC
	measuring circuit / output circuits	250 V AC / 300 V DC		250 V AC / 250 V DC
Pollution degree			3	
Overvoltage category			III	
Standards / Directives				
Standards	IEC/EN 60255-27, IEC/EN 60947-5-1			
Low Voltage Directive	2014/35/EU			
EMC Directive	2014/30/EU			
RoHS Directive	2011/65/EU			
Electromagnetic compatibility				
Interference immunity to electrostatic discharge	IEC/EN 61000-4-2	IEC/EN 61000-6-2 level 3, 6 kV / 8 kV		
	IEC/EN 61000-4-3	level 3, 10 V/m (1 GHz) / 3 V/m (2 GHz) / 1 V/m (2.7 GHz)		
radiated, radio-frequency, electromagnetic field	IEC/EN 61000-4-4	level 3, 2 kV / 5 kHz		
	IEC/EN 61000-4-5	level 3, installation class 3, supply circuit and measuring circuit 1 kV L-L, 2 kV L-earth		
electrical fast transient/burst surge	IEC/EN 61000-4-6	level 3, 10 V		
	IEC/EN 61000-4-11	class 3		
conducted disturbances, induced by radio-frequency fields	IEC/EN 61000-4-13	class 3		
	IEC/EN 61000-4-13	class 3		
Interference emission	IEC/EN 61000-6-3	IEC/EN 61000-6-3		
	IEC/EN 61000-6-3	IEC/EN 61000-6-3		
high-frequency radiated	IEC/CISPR 22, EN 55022	class B		
high-frequency conducted	IEC/CISPR 22, EN 55022	class B		

Liquid level monitors and controls

Product group picture

2

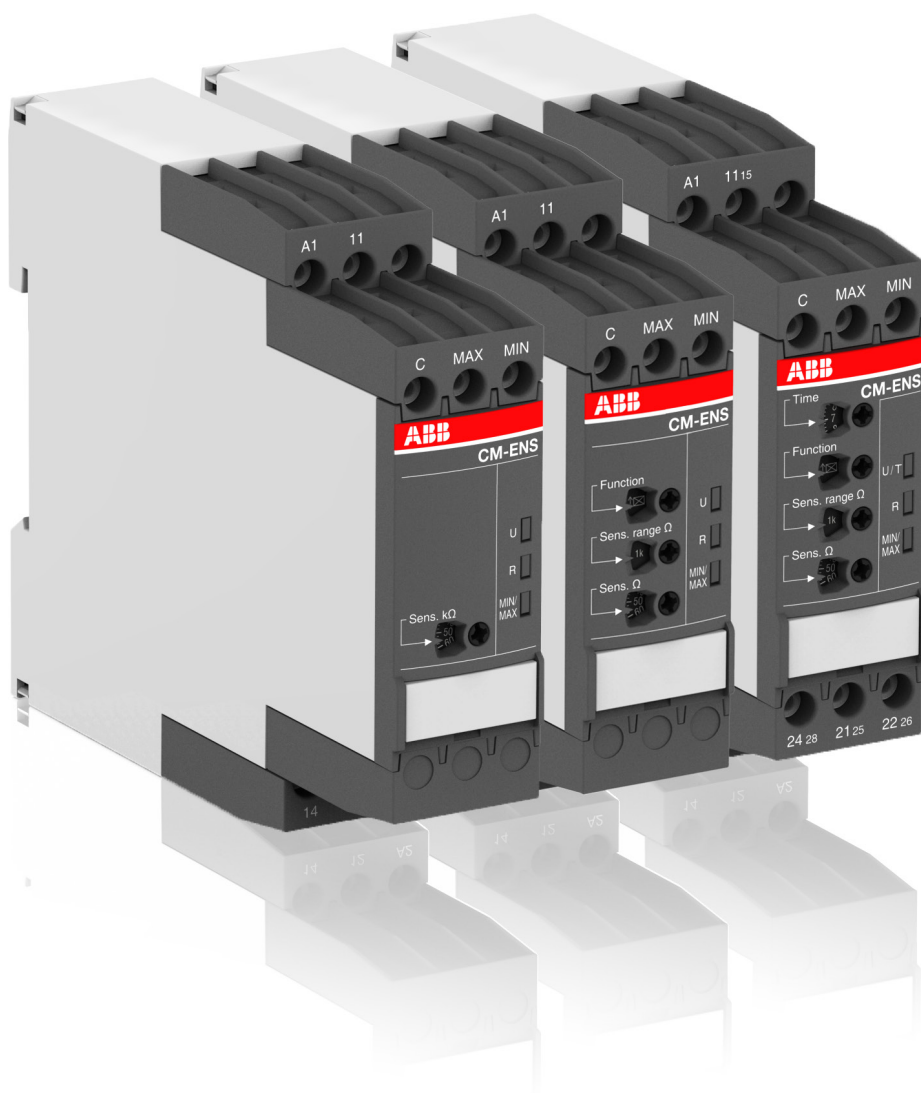

Liquid level monitors and controls

Table of contents

Liquid level monitors and controls

Benefits and advantages	2/95
Operating controls	2/96
Selection table - Liquid level monitors and controls	2/97
Ordering details	2/98
Function diagrams	2/99
Connection diagrams	2/100
Cascading of several devices, application examples	2/101
Technical data - CM-ENE	2/102
Technical data - CM-ENS	2/103

Liquid level monitors and controls

Benefits and advantages

2

CM-ENS.1x

- Control of one or two liquid levels (min/max)
- Fill or drain function
- Adjustable response sensitivity 5-100 k Ω

CM-ENS.2x

- Control of one or two liquid levels (min/max)
- Fill (UP) or Drain (DOWN), adjustable via front-face potentiometer
- Adjustable response sensitivity 0.1-1000 k Ω

CM-ENS.31

- Control of one or two liquid levels (min/max)
- Fill (UP) or Drain (DOWN), adjustable via front-face potentiometer
- Adjustable response sensitivity 0.1-1000 k Ω
- Selectable ON- or OFF-delay
- 2 c/o (SPDT) contacts

All CM-ENS devices

- Devices with wide rated control supply voltage 24-240 V AC/DC
- Cascadable
- High EMC immunity
- 3 LEDs for the indication of operational states
- Screw connection technology or Easy Connect Technology
- Housing material for highest fire protection classification UL 94 V-0
- Tool-free mounting and demounting on DIN rail
- 22.5 mm (0.89 in) width

ABB's liquid level monitoring relays are the ideal solution to regulate and control liquid levels and ratios of mixtures of conductive fluids. The assortment includes single- or multifunctional devices which can be used for overflow protection, dry-running protection of pumps, filling and draining applications as well as max. and min. level alarming.



Global availability

You will find ABB control products in any application and corner of the world. They are in skyscrapers or windfarms, in offshore platforms or industrial areas which power the world. Approved by local and international standards. We believe in the strength of our brand and products - which is supported by our global service network to ensure your peace of mind.

- Latest approvals supports your installation complies to your local standards
- The product can be used in all installations in the world
- Giving you the confidence of world-wide sourcing - no matter where you build, install or operate your equipment



Reliable in harsh conditions

Our engineers thrive on the challenge to develop products that need to operate in the most difficult electrical, mechanical and environmental conditions. Our solutions protect your application from overloads, network irregularities, mechanical wear, and environmental stresses ensuring your peace of mind. When you buy an ABB product, you buy extensive environmental testing guarantee.

- High immunity against electromagnetic disturbances due to advanced measuring technology
- Operation in environment with high vibrations



Improve installation efficiency

In everything we do, we think of the customer and the application first. Our engineers constantly look for ways to simplify the installation process by developing innovative product designs which facilitate the product assembly and avoid mounting errors. ABB product can improve our customers' productivity and machinery quality.

- Simplified wiring even in case of different cable diameters
- Easy to adjust via front-face potentiometer
- Tool-free mounting and demounting
- Tool free installation due to push-in technology

Liquid level monitors and controls

Operating controls

CM-ENS.1x

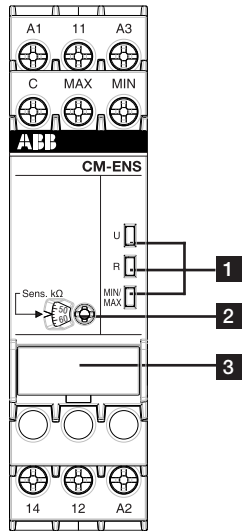

1 Indication of operational states with LEDs

- U: green LED - Status indication of control supply voltage
 control supply voltage applied
- R: yellow LED - Status indication of the output relays
 energized
- MIN/MAX: yellow LED - Status indication of the electrodes
 MIN and MAX wet
 MIN wet

2 Adjustment of the response sensitivity

- R: yellow LED - relay status
- U: green LED - control supply voltage

3 Marker label

CM-ENS.2x

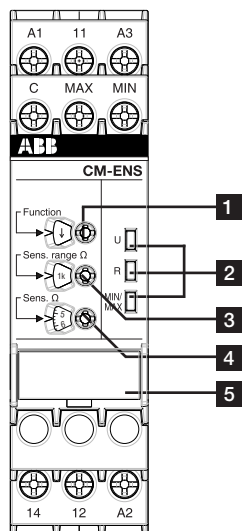

1 Adjustment of the function

- ↑ Fill
- ↓ Drain

2 Indication of operational states

- U: green LED - Status indication of control supply voltage
 control supply voltage applied
- R: yellow LED - Status indication of the output relays
 energized
- MIN/MAX: yellow LED - Status indication of the electrodes
 MIN and MAX wet
 MIN wet

3 Adjustment of the response sensitivity range

4 Adjustment of the response sensitivity

5 Marker label

CM-ENS.31

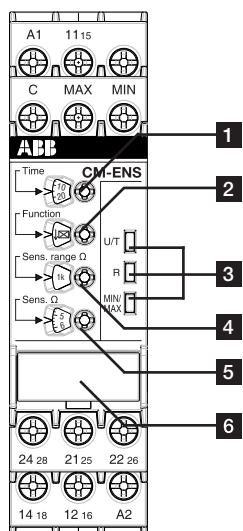

1 Adjustment of the time delay

2 Adjustment of the function

- ↑ ON-delayed Fill
- ↑ ON-delayed Drain
- ↓ OFF-delayed Fill
- ↓ OFF-delayed Drain

3 Indication of operational states

- U: green LED - Status indication of control supply voltage
 control supply voltage applied
 time delay is running
- R: yellow LED - Status indication of the output relays
 energized
- MIN/MAX: yellow LED - Status indication of the electrodes
 MIN and MAX wet
 MIN wet

4 Adjustment of the response sensitivity range

5 Adjustment of the response sensitivity

6 Marker label

Liquid level monitors and controls

Selection table - Liquid level monitors and controls

2

	1SVR 550 855 R9500	1SVR 550 850 R9500	1SVR 550 851 R9500	1SVR 550 855 R9400	1SVR 550 850 R9400	1SVR 550 851 R9400	1SVR 730 850 R0100	1SVR 740 850 R0100	1SVR 730 850 R2100	1SVR 740 850 R2100	1SVR 730 850 R0200	1SVR 740 850 R0200	1SVR 730 850 R2200	1SVR 740 850 R2200	1SVR 730 850 R0300	1SVR 740 850 R0300
	CM-ENE MIN	CM-ENE MIN	CM-ENE MIN	CM-ENE MAX	CM-ENE MAX	CM-ENE MAX	CM-ENS.11S	CM-ENS.11P	CM-ENS.13S	CM-ENS.13P	CM-ENS.21S	CM-ENS.21P	CM-ENS.23S	CM-ENS.23P	CM-ENS.31S	CM-ENS.31P
Rated control supply voltage U_s																
24-240 V AC/DC							■	■			■	■			■	■
24 V AC	■			■												
110-130 V AC		■			■				■	■			■	■		
220-240 V AC			■			■			■	■			■	■		
Sensor circuit																
Number of electrodes (including ground reference)	2	2	2	2	2	2	3	3	3	3	3	3	3	3	3	3
Response sensitivity range																
0-100 kOhm	■	■	■	■	■	■										
5-100 kOhm							adj	adj	adj	adj						
0.1-1000 kOhm											adj	adj	adj	adj	adj	adj
Monitoring function																
Dry running protection	■	■	■				■	■	■	■	■	■	■	■	■	■
Overflow protection				■	■	■	■	■	■	■	■	■	■	■	■	■
Liquid level control				■	■	■	■	■	■	■	■	■	■	■	■	■
Operating principle																
Open-circuit principle	■	■	■				■	■	■	■						
Closed-circuit principle				■	■	■										
Open- or closed-circuit principle											sel	sel	sel	sel	sel	sel
Adjustable ON-/OFF-delay																
0.1-10 s															■	■
Output contacts																
n/o	1	1	1	1	1	1										
c/o (SPTD)							1	1	1	1	1	1	1	1	2	2
Connection type																
Push-in terminals							■	■	■	■	■	■	■	■	■	■
Double-chamber cage connection terminals							■	■	■	■	■	■	■	■	■	■

adj: adjustable
sel: selectable

Liquid level monitors and controls

Ordering details



CM-ENE MIN

1SVR550851R9500



CM-ENS.3x

2CDC251004V0015



Bar electrode

1SVR450056R6000



Suspension electrode

1SVC110000F0478

Description

The liquid level monitoring relay CM-ENS monitors and controls the liquid level and ratios of mixtures of conductive fluids. It is used for filling and draining applications, to protect pumps against dry-running, tanks against overflow and for signalization of the status of the monitored liquid level.

Liquid level monitoring relays are

Suitable for		Not suitable for	
spring water	acids, bases	chemically pure water	ethylene glycol
drinking water	liquid fertilizers	fuel	concentrated alcohol
sea water	milk, beer, coffee	oils	paraffin
sewage	non-concentrated alcohol	explosive areas (liquid gas)	lacquers

Ordering details

Characteristics	Type	Order code	Price	Weight
			1 pc	(1 pc) kg (lb)
See "Selection table - Liquid level monitors and controls" on page 2/97.	CM-ENE MIN	1SVR550855R9500		0.15 (0.33)
		1SVR550850R9500		0.15 (0.33)
	CM-ENE MAX	1SVR550851R9500		0.15 (0.33)
		1SVR550855R9400		0.15 (0.33)
		1SVR550850R9400		0.15 (0.33)
		1SVR550851R9400		0.15 (0.33)

Ordering details

Characteristics	Type	Order code	Price	Weight
			1 pc	(1 pc) kg (lb)
See "Selection table - Liquid level monitors and controls" on page 2/97.	CM-ENS.11S	1SVR730850R0100		0.124 (0.273)
	CM-ENS.11P	1SVR740850R0100		0.117 (0.258)
	CM-ENS.13S	1SVR730850R2100		0.153 (0.337)
	CM-ENS.13P	1SVR740850R2100		0.145 (0.320)
	CM-ENS.21S	1SVR730850R0200		0.125 (0.276)
	CM-ENS.21P	1SVR740850R0200		0.117 (0.258)
	CM-ENS.23S	1SVR730850R2200		0.154 (0.340)
	CM-ENS.23P	1SVR740850R2200		0.147 (0.324)
	CM-ENS.31S	1SVR730850R0300		0.143 (0.315)
	CM-ENS.31P	1SVR740850R0300		0.134 (0.295)

S: screw connection
P: push-in connection

Ordering details - Bar electrodes

Description	Material no.	Type	Order code	Price	Weight
				1 pc	(1 pc) kg (lb)
Compact support for 3 bar electrodes	-	CM-KH-3	1SVR450056R6000		0.06 (0.132)
Distance plate for 3 bar electrodes	-	CM-AH-3	1SVR450056R7000		0.06 (0.132)
Counter nut for 1" thread	-	CM-GM-1	1SVR450056R8000		0.06 (0.132)
Length: 300 mm	1.4301	CM-SE-300	1SVR450056R0000		0.08 (0.176)
Length: 600 mm	1.4301	CM-SE-600	1SVR450056R0100		0.08 (0.176)
Length: 1000 mm	1.4301	CM-SE-1000	1SVR450056R0200		0.08 (0.176)

Ordering details - Suspension electrodes

Description	Material no.	Type	Order code	Price	Weight
				1 pc	(1 pc) kg (lb)
CM-HE suspension electrode	1.4104	CM-HE	1SVR402902R0000		0.074 (0.163)
CM-HC suspension electrode	1.4104	CM-HC	1SVR402902R1000		0.09 (0.198)
CM-HCT suspension electrode suitable for drinking water	1.4301	CM-HCT	1SVR402902R2000		0.09 (0.198)



Further documentation liquid level monitoring relays on www.abb.com

Liquid level monitors and controls

Function diagrams

CM-ENS

2

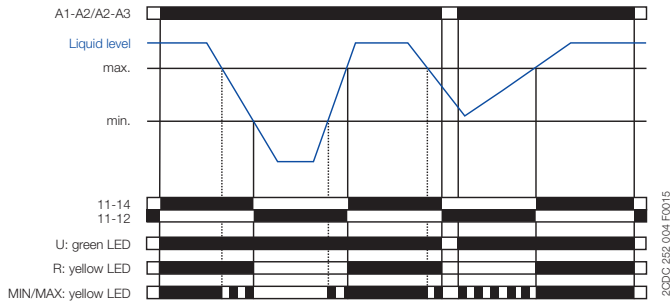

Drain: CM-ENS.1x, CM-ENS.2x

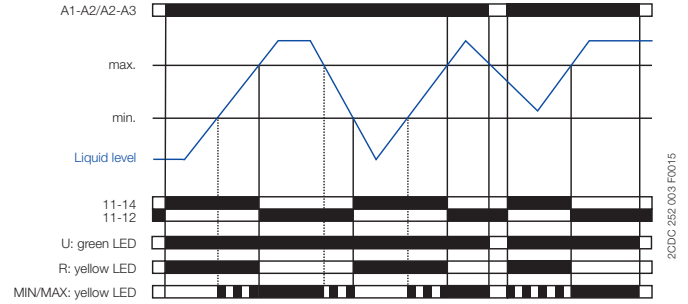

Fill: CM-ENS.2x

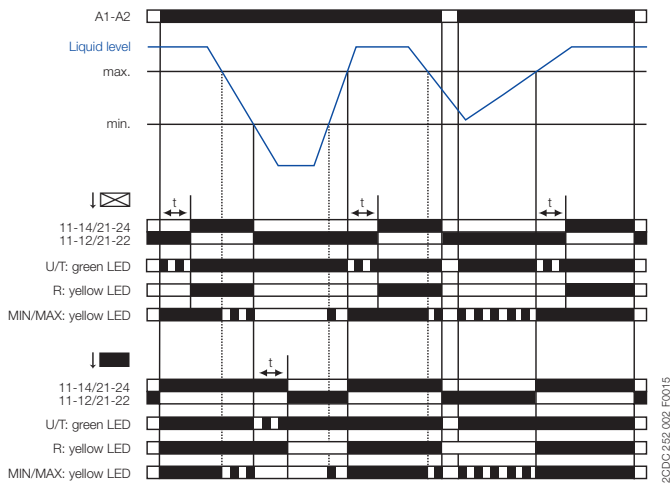

Drain: CM-ENS.31

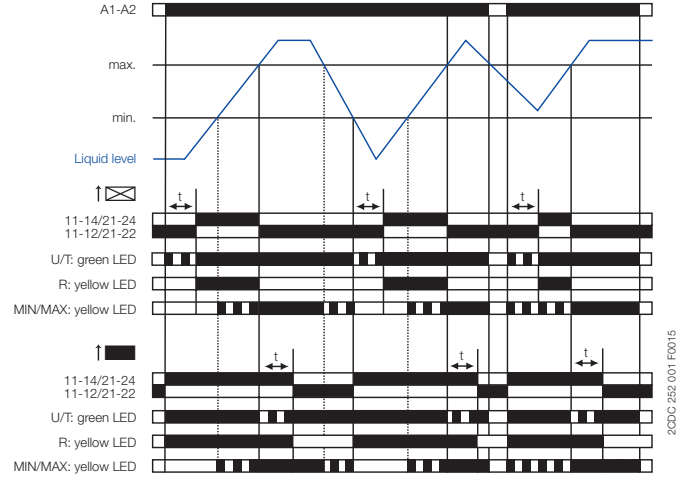

Fill: CM-ENS.31

CM-ENE MIN

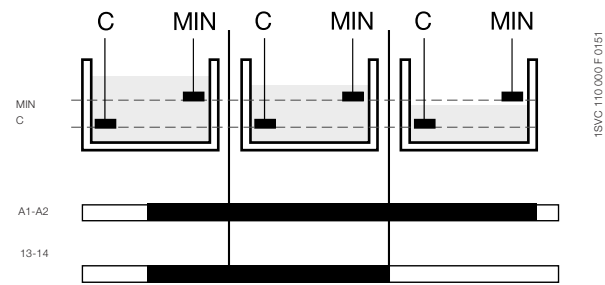

1S/C 110 000 F 0151

CM-ENE MAX

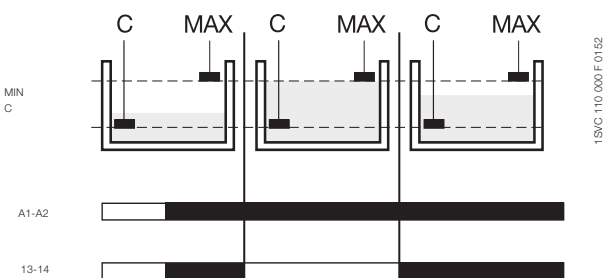

1S/C 110 000 F 0152

The liquid level relays CM-ENE MIN and CM-ENE MAX are used to monitor levels of conductive liquids, for example in pump control systems for dry-running or overflow monitoring.

The measuring principle is based on the occurring resistance change when moistening single-pole electrodes. The single-pole electrodes (see also section Accessories) are connected to the terminals C and MIN or MAX.

If the supply voltage is applied to A1-A2 and the electrodes are wet, the output relay of the CM-ENE MIN is energized and the output relay of the CM-ENE MAX is de-energized.

The output relay of the CM-ENE MIN de-energizes if the electrodes are no longer wet. The output relay of the CM-ENE MAX energizes if the electrodes are no longer wet.

Liquid level monitors and controls

Connection diagrams

CM-ENS.11, CM-ENS.21

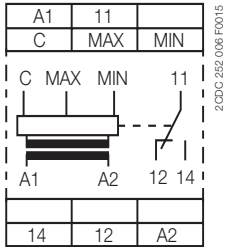

- A1-A2 Control supply voltage
 11-12/14 1 c/o (SPDT) contact
 C Reference electrode
 MAX Maximum level electrode
 MIN Minimum level electrode

CM-ENS.13, CM-ENS.23

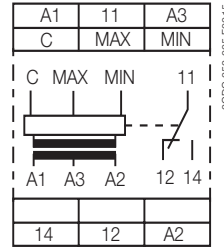

- A1-A2 Control supply voltage
 220-240 V AC
 A3-A2 Control supply voltage
 110-130 V AC
 11-12/14 1 c/o (SPDT) contact
 C Reference electrode
 MAX Maximum level electrode
 MIN Minimum level electrode

CM-ENS.31

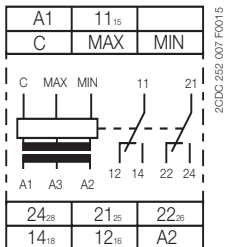

- A1-A2 Control supply voltage
 11₁₅-12₁₆/14₁₈ 1 c/o (SPDT) contact
 21₂₅-22₂₆/24₂₈ 2nd c/o (SPDT) contact
 C Reference electrode
 MAX Maximum level electrode
 MIN Minimum level electrode

CM-ENE MIN

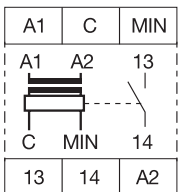

- A1-A2 Rated control supply voltage
 C Reference electrode
 MIN Minimum level
 13-14 Output contact -open-circuit principle

CM-ENE MAX

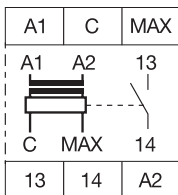

- A1-A2 Rated control supply voltage
 C Reference electrode
 MIN Maximum level
 13-14 Output contact -open-circuit principle

Liquid level monitors and controls

Cascading of several devices, application examples

Two devices in one tank

Several CM-ENS can be used in one tank. This extends the functionality with a pre-warning by two additional electrodes. In this way, two additional alarm outputs for exceeding or dropping below the normal level can be implemented in addition to the filling levels MAX and MIN.

2

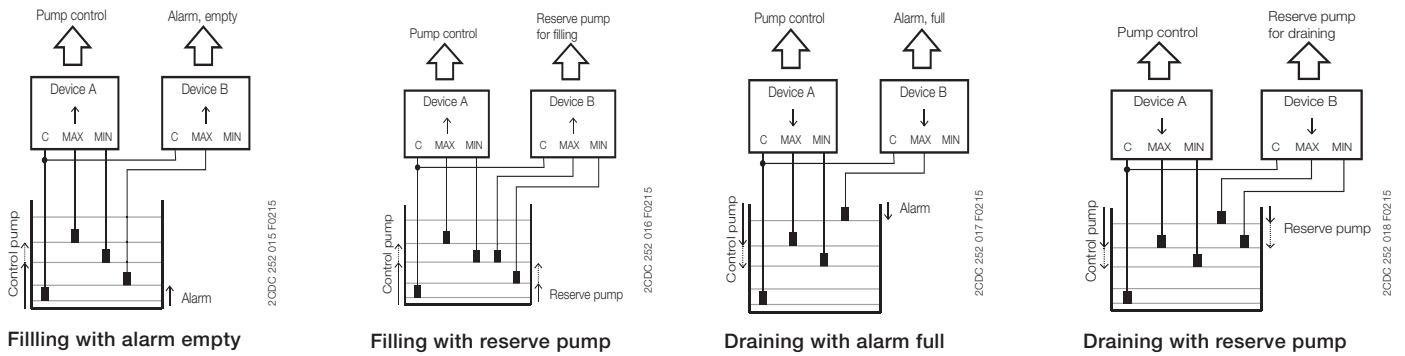

Application examples

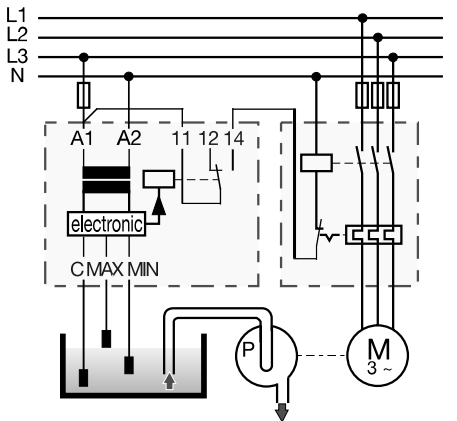

CM-ENS.1x
Liquid level control - drain

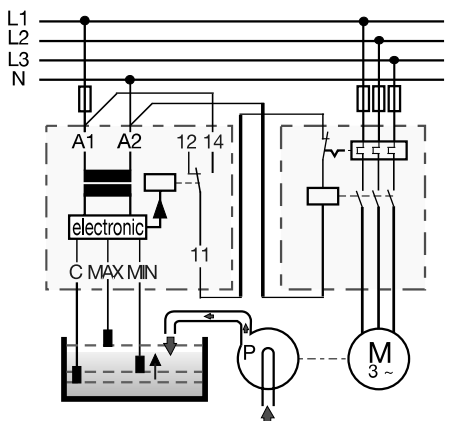

CM-ENS.2x, CM-ENS.31
Liquid level control - fill - selected function "↑" (UP)

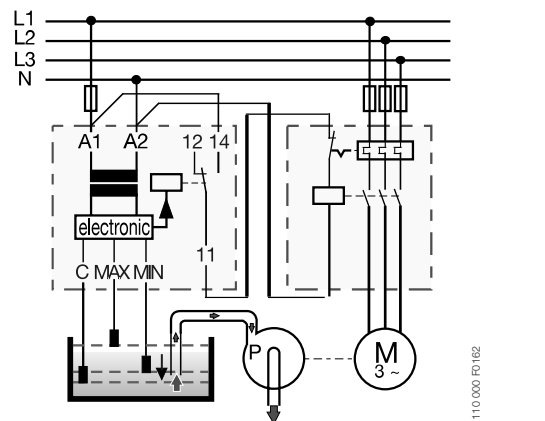

CM-ENS.2x, CM-ENS.31
Liquid level control - drain - selected function "↓" (Down)

Liquid level monitors and controls

Technical data - CM-ENE

Type		CM-ENE MIN	CM-ENE MAX
Supply circuit			
Rated control supply voltage U_s - power consumption	A1-A2	24 V AC approx. 1.5 VA	
	A1-A2	110-130 V AC approx. 1.2 VA	
	A1-A2	220-240 V AC approx. 1.4 VA	
Rated control supply voltage U_s tolerance		-15...+15 %	
Rated frequency		50-60 Hz	
Measuring circuit			
Monitoring function		dry-running protection	overflow protection
Response sensitivity		0-100 k Ω , not adjustable	
Maximum electrode voltage / current		30 V AC / 1.5 mA	
Electrode supply line	max. cable length / capacity	30 m / 3 nF	
Timing circuit			
Tripping delay		fixed approx. 200 ms	
Indication of operational states			
Output relay energized		R: yellow LED	
Output circuits			
Kind of output		1 n/o contact	
Operational principle		open-circuit principle ¹⁾	closed-circuit principle ¹⁾
Minimum switching voltage / minimum switching current		- / -	
Maximum switching voltage		250 V	
Rated operational voltage U_o and rated operational current I_o	AC-12 (resistive) 230 V	4 A	
	AC-15 (inductive) 230 V	3 A	
	DC-12 (resistive) 24 V	4 A	
	DC-13 (inductive) 24 V	2 A	
AC rating (UL 508)	utilization category (Control Circuit Rating Code)	B 300	
	max. rated operational voltage	300 V AC	
	max. continuous thermal current at B 300	5 A	
	max. making/breaking apparent power at B 300	3600/360 VA	
Mechanical lifetime		30 x 10 ⁶ switching cycles	
Electrical lifetime (AC-12, 230 V, 4 A)		0.3 x 10 ⁶ switching cycles	
Max. fuse rating to achieve short-circuit protection	n/c contact	-	
	n/o contact	10 A fast-acting	
General data			
Duty cycle		100 %	
Dimensions		see 'Dimensional drawings'	
Mounting		DIN rail (IEC/EN 60715)	
Mounting position		any	
Degree of protection	housing / terminals	IP50 / IP20	
Electrical connection			
Connecting capacity	fine-strand with wire-end ferrule	2 x 0.75-1.5 mm ² (2 x 18-16 AWG)	
	fine-strand without wire-end ferrule	2 x 1-1.5 mm ² (2 x 18-16 AWG)	
	rigid	2 x 0.75-1.5 mm ² (2 x 18-16 AWG)	
Stripping length		10 mm (0.39 inch)	
Tightening torque		0.6-0.8 Nm	
Environmental data			
Ambient temperature ranges	operation/storage	-20...+60 °C / -40...+85 °C	
Damp heat	IEC/EN 60068-2-30	40 °C, 93 % RH, 4 days	
Vibration withstand	IEC/EN 60068-2-6	10-57 Hz: 0.075 mm; 57-150 Hz: 1 g	
Isolation data			
Rated insulation voltage U between supply, measuring / output circuit		250 V	
Rated impulse withstand voltage U_{imp} between all isolated circuits		4 kV / 1.2-50 μ s	
Pollution degree		3	
Overvoltage category		III	
Standards / Directives			
Standards		IEC/EN 60947-5-1, EN 50178	
Low Voltage Directive		2014/35/EU	
EMC Directive		2014/30/EU	
RoHS Directive		2011/65/EU	
Electromagnetic compatibility			
Interference immunity to		IEC/EN 61000-6-2	
electrostatic discharge	IEC/EN 61000-4-2	level 3 (6 kV / 8 kV)	
radiated, radio-frequency, electromagnetic field	IEC/EN 61000-4-3	level 3 (10 V/m)	
electrical fast transient / burst	IEC/EN 61000-4-4	level 3 (2 kV / 5 kHz)	
surge	IEC/EN 61000-4-5	level 4 (2 kV L-L)	
conducted disturbances, induced by radio-frequency fields	IEC/EN 61000-4-6	level 3 (10 V)	
Interference emission		IEC/EN 61000-6-3	
high-frequency radiated	IEC/CISPR 22, EN 55022	class B	
high-frequency conducted	IEC/CISPR 22, EN 55022	class B	

¹⁾ Open-circuit principle: Output relay energizes if the measured value exceeds/drops below the adjusted threshold.

Closed-circuit principle: Output relay de-energizes if the measured value exceeds/drops below the adjusted threshold.

Liquid level monitors and controls

Technical data - CM-ENS

2

Type		CM-ENS.1x	CM-ENS.2x	CM-ENS.31	
Supply circuit					
Rated control supply voltage U_s	CM-ENS.11, CM-ENS.21, CM-ENS.31: A1-A2	24-240 V AC/DC			
	CM-ENS.13, CM-ENS.23: A1-A2	220-240 V AC			
	CM-ENS.13, CM-ENS.23: A3-A2	110-130 V AC			
Rated control supply voltage U_s tolerance		-15...+10 %			
Rated frequency		50-60 Hz			
Frequency range		47-63 Hz			
Typical current / power consumption	24 V AC	25 mA / 0.6 W	25 mA / 0.6 W	25 mA / 0.6 W	
	110-130 V AC	20 mA / 2.6 VA	20 mA / 2.6 VA	8 mA / 1.1 VA	
	220-240 V AC	8.5 mA / 2.1 VA	8.5 mA / 2.1 VA	10 mA / 2.4 VA	
	24-240 V AC/DC	11 mA / 2.6 VA	11 mA / 2.6 VA	11 mA / 2.6 VA	
Power failure buffering time	min.	20 ms			
Start-up time t_s	range 5-100 k Ω	max. 1.3 s	-	-	
	range 0.1-1 k Ω	-	max. 900 ms	-	
	range 1-10 k Ω	-	max. 900 ms	-	
	range 10-100 k Ω	-	max. 1.3 s	-	
	range 100-1000 k Ω	-	max. 6.3 s	-	
Measuring circuit					
Sensor type		electrode			
Monitoring function		fill or drain	fill or drain, selectable		
Measuring principle		conductivity measurement			
Number of electrodes		3			
Response sensitivity		adjustable: 5-100 k Ω	adjustable: 0.1-1000 k Ω		
Maximum electrode voltage		6 V AC			
Maximum electrode current		1 mA	2 mA		
		max cable capacity	max cable length	max cable capacity	max cable length
Electrode supply line	range 5-100 k Ω	10 nF	100 m	-	-
	range 0.1-1 k Ω	-	-	200 nF	1000 m
	range 1-10 k Ω	-	-	200 nF	1000 m
	range 10-100 k Ω	-	-	20 nF	100 m
	range 100-1000 k Ω	-	-	4 nF	20 m
Max. measuring cycle	range 5-100 k Ω	1000 ms	-	-	-
	range 0.1-1 k Ω	-	-	700 ms	-
	range 1-10 k Ω	-	-	700 ms	-
	range 10-100 k Ω	-	-	1.1 s	-
	range 100-1000 k Ω	-	-	5 s	-
Timing circuit					
Time delay		-	0.1-30 s, adjustable, ON- or OFF-delay		
Indication of operational states					
Control supply voltage		U: green LED			
Output relay energized		R: Yellow LED			
Electrode / alarm status		MAX/MIN: Yellow LED			
Output circuits					
Kind of output	11 ₁₅ -12 ₁₆ /14 ₁₈	relay, 1 c/o (SPDT) contact		relay, 1st c/o (SPDT) contact	
	21 ₁₅ -22 ₁₆ /24 ₁₈	-		relay, 2nd c/o (SPDT) contact	
Operational principle		open-circuit principle	open- or closed-circuit principle (selectable)		
Contact material		AgNi alloy, Cd free			
Minimum switching voltage / minimum switching current		12 V / 10 mA			
Maximum switching voltage / Maximum switching current		see data sheets			
Rated operational voltage U_o and rated operational current I_o	AC-12 (resistive) 230 V	4 A			
	AC-15 (inductive) 230 V	3 A			
	DC-12 (resistive) 24 V	4 A			
	DC-13 (inductive) 24 V	2 A			
AC rating (UL 508)	utilization category (Control Circuit Rating Code)	B 300 pilot duty; general purpose 250 V, 4 A, $\cos \varphi$ 0.75			
	max. rated operational voltage	300 V AC			
	max. continuous thermal current at B 300	5 A			
	max. making/breaking apparent power at B 300	3600/360 VA			
Mechanical lifetime		10 x 10 ⁶ switching cycles			
Electrical lifetime (AC-12, 230 V, 4 A)		0.1 x 10 ⁶ switching cycles			
Max. fuse rating to achieve short-circuit protection	n/c / n/o contact	6 A / 10 A fast-acting		10 A / 10 A fast-acting	
Conventional thermal current I_{th}		4 A			

Liquid level monitors and controls

Technical data - CM-ENS

Type		CM-ENS.1x	CM-ENS.2x	CM-ENS.31
General data				
MTBF		on request		
Duty cycle		100 %		
Dimensions		see 'Dimensional drawings'		
Mounting		DIN rail (IEC/EN 60715), snap-on mounting without any tool		
Mounting position		any		
Minimum distance to other units		CM-ENS.x1: not necessary CM-ENS.x3: 10 mm if contact current > 2 A		
Degree of protection	housing / terminals	IP50 / IP20		
Material of housing		UL 94 V-0		
Electrical connection				
Connecting capacity	fine-strand with(out) wire end ferrule	Screw connection technology 1 x 0.5-2.5 mm ² (1 x 18-14 AWG) 2 x 0.5-1.5 mm ² (2 x 18-16 AWG)	Easy Connect Technology (push-in) 2 x 0.5-1.5 mm ² (2 x 18-16 AWG)	
	rigid	1 x 0.5-4 mm ² (1 x 20-12 AWG) 2 x 0.5-2.5 mm ² (2 x 20-14 AWG)	2 x 0.5-1.5 mm ² (2 x 20-16 AWG)	
Stripping length		8 mm (0.32 in)		
Tightening torque		0.6-0.8 Nm (7.08 lb.in)		-
Environmental data				
Ambient temperature ranges	operation	-25...+60 °C		
	storage	-40...+85 °C		
Damp heat, cyclic	IEC/EN 60068-2-30	6 x 24 h cycle, 55 °C, 95 % RH		
Climatic class	IEC/EN 60721-3-3	3K5 (no condensation, no ice formation)		
Vibration, sinusoidal		class 2		
Shock		class 2		
Isolation data				
Rated impulse withstand voltage U_{imp}	supply circuit / measuring circuit	4 kV		
	supply circuit / output circuits	4 kV		
	measuring circuit / output circuits	4 kV		
	output circuit 1 / output circuit 2	4 kV		
Rated insulation voltage U_i	supply circuit / measuring circuit	300 V		
	supply circuit / output circuits	300 V		
	measuring circuit / output circuits	300 V		
	output circuit 1 / output circuit 2	300 V		
Basic insulation	supply circuit / measuring circuit	250 V AC / 300 V DC		
	supply circuit / output circuits	250 V AC / 300 V DC		
	measuring circuit / output circuits	250 V AC / 300 V DC		
	output circuit 1 / output circuit 2	250 V AC / 300 V DC		
Protective separation (IEC/EN 61140, EN 50178)	supply circuit / measuring circuit	250 V AC / 300 V DC		
	supply circuit / output circuits	250 V AC / 300 V DC		
	measuring circuit / output circuits	250 V AC / 300 V DC		
Pollution degree		3		
Overvoltage category		III		
Standards / Directives				
Standards		IEC/EN 60255-27, IEC/EN 60947-5-1		
Low Voltage Directive		2014/35/EU		
EMC Directive		2014/30/EU		
RoHS Directive		2011/65/EU		
Electromagnetic compatibility				
Interference immunity to	electrostatic discharge	IEC/EN 61000-4-2	IEC/EN 61000-6-2, IEC/EN 60255-26 level 3 (6 kV / 8 kV)	
	radiated, radio-frequency, electromagnetic field	IEC/EN 61000-4-3	level 3 (10 V/m)	
	electrical fast transient / burst	IEC/EN 61000-4-4	level 3, 2 kV / 5 kHz	
	surge	IEC/EN 61000-4-5	level 3, installation class 3, supply circuit and measuring circuit 1 kV L-L, 2 kV L-earth	
	conducted disturbances, induced by radio-frequency fields	IEC/EN 61000-4-6	level 3, 10 V	
	voltage dips, short interruptions and voltage variations	IEC/EN 61000-4-11	class 3	
Interference emission	high-frequency radiated	IEC/CISPR 22, EN 55022	IEC/EN 61000-6-3 class B	
	high-frequency conducted	IEC/CISPR 22, EN 55022	class B	

General technical data

Technical diagrams - CM-range

Load limit curves

CM-E (22.5 mm), CM-N (45 mm), CM-S (22.5 mm), CM-UFD.Mxx

AC load (resistive)

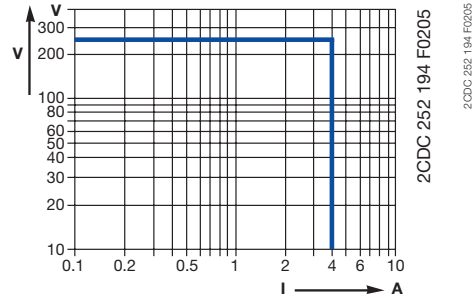

DC load (resistive)

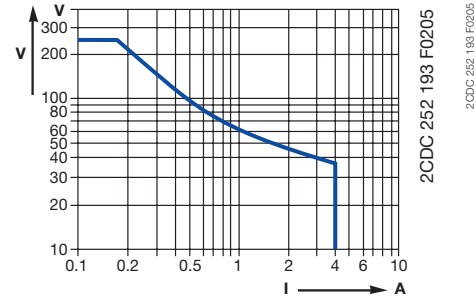

Derating factor F for inductive AC load

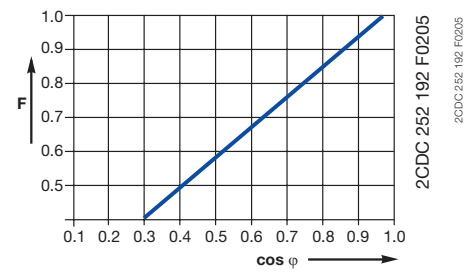

Contact lifetime

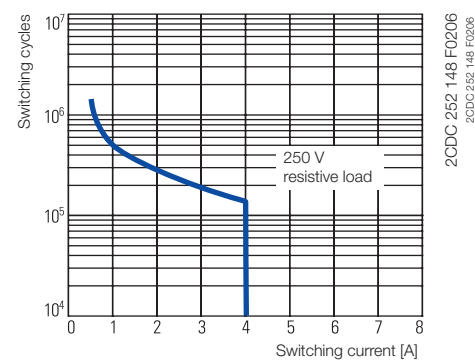

General technical data

Dimensional drawings

Measuring and monitoring relays CM range, old housing

Dimensions in mm

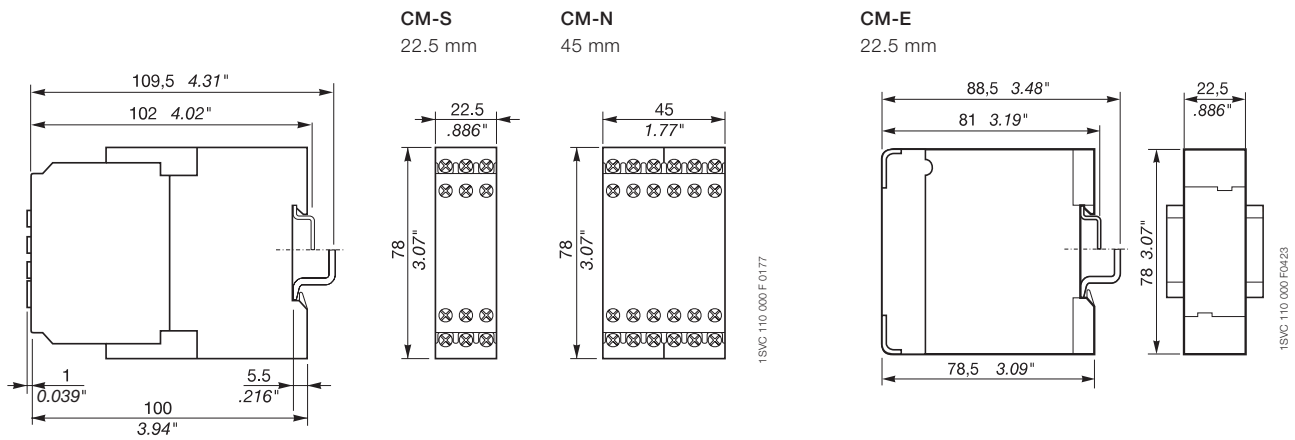

Measuring and monitoring relays CM range, new housing

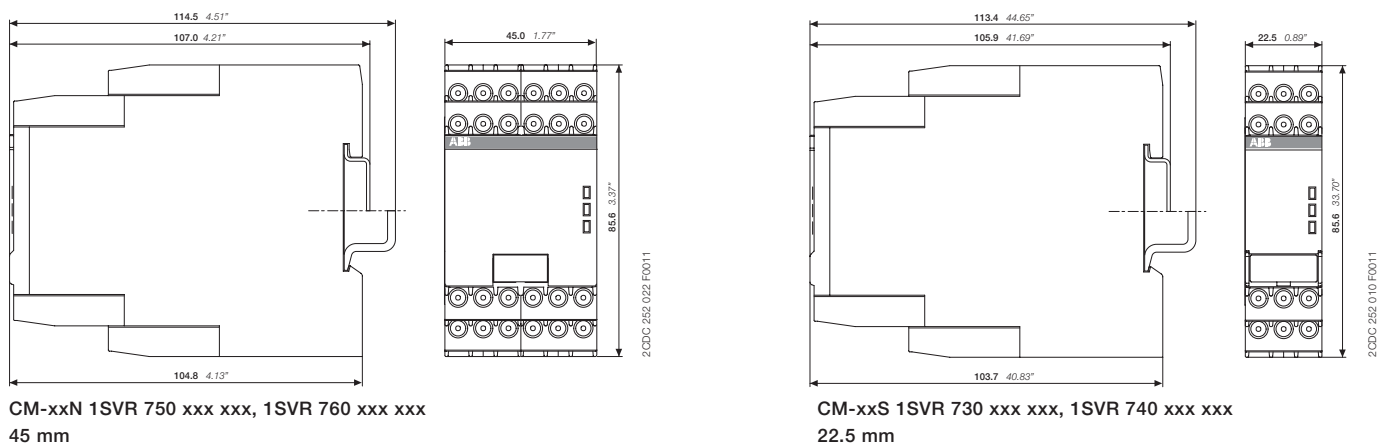

Grid feeding monitoring relays CM-UFD.M*

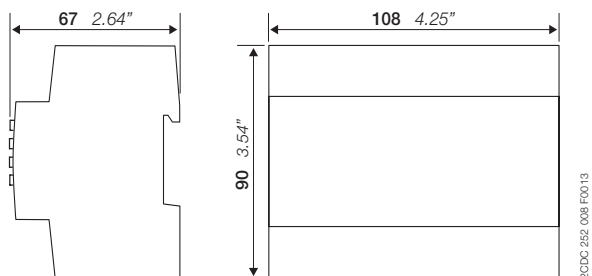

Accessories, Current transformers

Ordering details - CM-range accessories

2

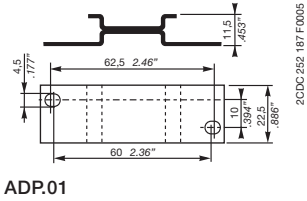

ADP.01

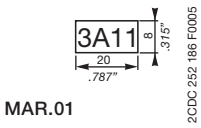

MAR.01

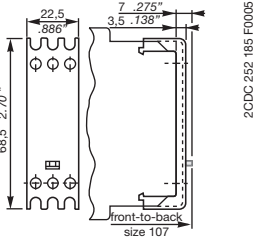

Sealable cover
COV.01

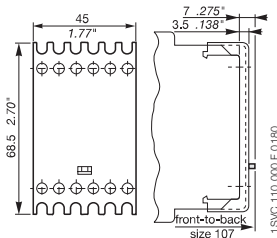

Sealable cover
COV.02

Accessories

Ordering details

Description	For type	Width in mm	for devices	Type	Order code	Price pc	Pkg qty	Weight (1 pc) g (oz)
Adapter for screw mounting	CM-S CM-S.S/P	22.5		ADP.01	1SVR430029R0100		1	18.4 (0.65)
	CM-N CM-N.S/P	45		ADP.02	1SVR440029R0100		1	36.7 (1.30)
Marker label	CM-S, CM-N CM-S.S/P CM-N.S/P		without DIP switches	MAR.01	1SVR366017R0100		10	0.19 (0.007)
	CM-S, CM-N		with DIP switches	MAR.02	1SVR430043R0000		10	0.13 (0.005)
	CM-S.S/P CM-N.S/P		with DIP switches	MAR.12	1SVR730006R0000		10	0.152 (0.335)
Sealable transparent cover	CM-S	22.5		COV.01	1SVR430005R0100		1	5.2 (0.18)
	CM-N	45		COV.02	1SVR440005R0100		1	7.7 (0.27)
	CM-S.S/P	22.5		COV.11	1SVR730005R0100		1	4.0 (0.129)
	CM-N.S/P	45		COV.12	1SVR750005R0100		1	7 (0.247)

Accessories, Current transformers

Ordering details - CM-CT current transformers

2CDC 251 002 F0005



CM-CT

Plug-in current transformers CM-CT

- Without primary conductor though with foot angle, insulating protective cap and bar fastening screws
- Primary / rated current from 50 A to 600 A
- Secondary current of 1 A or 5 A
- Class 1

Ordering details

Rated primary current	Secondary current	Burden class	Type	Order code	Price pc	Weight (1 pc) g (oz)
50 A	1 A	1 VA / 1	CM-CT 50/1	1SVR450116R1000		0.31 (0.683)
75 A		1.5 VA / 1	CM-CT 75/1	1SVR450116R1100		0.31 (0.683)
100 A		2.5 VA / 1	CM-CT 100/1	1SVR450116R1200		0.276 (0.608)
150 A		2.5 VA / 1	CM-CT 150/1	1SVR450116R1300		0.32 (0.705)
200 A		2.5 VA / 1	CM-CT 200/1	1SVR450116R1400		0.222 (0.489)
300 A		5 VA / 1	CM-CT 300/1	1SVR450117R1100		0.29 (0.639)
400 A	5 A	5 VA / 1	CM-CT 400/1	1SVR450117R1200		0.27 (0.595)
500 A		5 VA / 1	CM-CT 500/1	1SVR450117R1300		0.29 (0.639)
600 A		5 VA / 1	CM-CT 600/1	1SVR450117R1400		0.24 (0.529)
50 A		1 VA / 1	CM-CT 50/5	1SVR450116R5000		0.3 (0.661)
75 A		1.5 VA / 1	CM-CT 75/5	1SVR450116R5100		0.31 (0.683)
100 A		2.5 VA / 1	CM-CT 100/5	1SVR450116R5200		0.31 (0.683)
150 A	5 A	2.5 VA / 1	CM-CT 150/5	1SVR450116R5300		0.28 (0.617)
200 A		5 VA / 1	CM-CT 200/5	1SVR450116R5400		0.29 (0.639)
300 A		5 VA / 1	CM-CT 300/5	1SVR450117R5100		0.252 (0.556)
400 A		5 VA / 1	CM-CT 400/5	1SVR450117R5200		0.26 (0.573)
500 A		5 VA / 1	CM-CT 500/5	1SVR450117R5300		0.208 (0.459)
600 A		5 VA / 1	CM-CT 600/5	1SVR450117R5400		0.21 (0.463)

2CDC 251 003 F0005



CM-CT with mounted accessories

Ordering details - Accessories

Description	Type	Order code	Price 10 pcs	Weight (1 pc) g (oz)
Snap-on fastener for DIN rail mounting of CM-CT	CM-CT A	1SVR450118R1000		0.009 (0.02)

2CDC 251 159 F0006



CM-CT-A mounted on DIN rail

Operating principle / circuit diagram

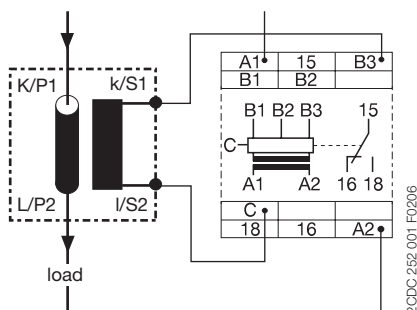

Dimensional drawing

