

C3M0060065D

Silicon Carbide Power MOSFET C3M™ MOSFET Technology
N-Channel Enhancement Mode

Features

- 3rd Generation SiC MOSFET technology
- High blocking voltage with low on-resistance
- High speed switching with low capacitances
- Fast intrinsic diode with low reverse recovery (Q_{rr})
- Halogen free, RoHS compliant

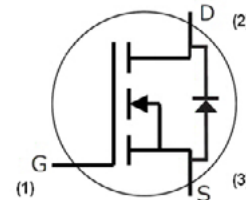

Wolfspeed, Inc. is in the process of rebranding its products and related materials pursuant to the entity name change from Cree, Inc. to Wolfspeed, Inc. During this transition period, products received may be marked with either the Cree name and/or logo or the Wolfspeed name and/or logo.

Ordering Part Number	Package	Marking
C3M0060065D	TO 247-3	C3M0060065D

Applications

- EV charging
- Server power supplies
- Solar PV inverters
- UPS
- DC/DC converters

Benefits

- Higher system efficiency
- Reduced cooling requirements
- Increased power density
- Increased system switching frequency
- Easy to parallel and simple to drive
- Enable new hard switching PFC topologies (Totem-Pole)

Key Parameters

Parameter	Symbol	Min.	Typ.	Max	Unit	Conditions	Note
Drain - Source Voltage	V_{DS}			650	V	$T_C = 25^\circ\text{C}$	
Maximum Gate - Source Voltage	$V_{GS(max)}$	-8		+19		Transient	
Operational Gate-Source Voltage	$V_{GS op}$		-4/15			Static	Note 1
DC Continuous Drain Current	I_D			29	A	$V_{GS} = 15\text{ V}, T_C = 25^\circ\text{C}, T_J \leq 175^\circ\text{C}$	Fig. 19
				20		$V_{GS} = 15\text{ V}, T_C = 100^\circ\text{C}, T_J \leq 175^\circ\text{C}$	Note 2
Pulsed Drain Current	I_{DM}			99		t_{Pmax} limited by T_{Jmax} $V_{GS} = 15\text{ V}, T_C = 25^\circ\text{C}$	Fig. 22
Power Dissipation	P_D			150	W	$T_C = 25^\circ\text{C}, T_J = 175^\circ\text{C}$	Fig. 20
Operating Junction and Storage Temperature	T_J, T_{stg}			-40 to +175	°C		
Solder Temperature	T_L			260		According to JEDEC J-STD-020	
Mounting Torque	M_D			1 8.8	Nm lbf-in	M3 or 6-32 screw	

Note (1): Recommended turn-on gate voltage is 15V with $\pm 5\%$ regulation tolerance, see Application Note PRD-04814 for additional details

Note (2): Verified by design



Electrical Characteristics ($T_c = 25^\circ\text{C}$ unless otherwise specified)

Parameter	Symbol	Min.	Typ.	Max.	Unit	Test Conditions	Note
Gate Threshold Voltage	$V_{GS(th)}$	1.8	2.3	3.6	V	$V_{DS} = V_{GS}, I_D = 5 \text{ mA}$	Fig. 11
		—	1.9	—		$V_{DS} = V_{GS}, I_D = 5 \text{ mA}, T_J = 175^\circ\text{C}$	
Zero Gate Voltage Drain Current	I_{DSS}	—	1	50	μA	$V_{DS} = 650 \text{ V}, V_{GS} = 0 \text{ V}$	
Gate-Source Leakage Current	I_{GSS}	—	10	250	nA	$V_{GS} = 15 \text{ V}, V_{DS} = 0 \text{ V}$	
Drain-Source On-State Resistance	$R_{DS(on)}$	42	60	79	m Ω	$V_{GS} = 15 \text{ V}, I_D = 13.2 \text{ A}$	Fig. 4, 5, 6
		—	80	—		$V_{GS} = 15 \text{ V}, I_D = 13.2 \text{ A}, T_J = 175^\circ\text{C}$	
Transconductance	g_{fs}	—	10	—	S	$V_{DS} = 20 \text{ V}, I_{DS} = 13.2 \text{ A}$	Fig. 7
		—	9	—		$V_{DS} = 20 \text{ V}, I_{DS} = 13.2 \text{ A}, T_J = 175^\circ\text{C}$	
Input Capacitance	C_{iss}	—	1020	—	pF	$V_{GS} = 0 \text{ V}, V_{DS} = 600 \text{ V}$ $f = 1 \text{ Mhz}$ $V_{AC} = 25 \text{ mV}$	Fig. 17, 18
Output Capacitance	C_{oss}	—	80	—			
Reverse Transfer Capacitance	C_{rss}	—	9	—			
Effective Output Capacitance (Energy Related)	$C_{o(er)}$	—	95	—			
Effective Output Capacitance (Time Related)	$C_{o(tr)}$	—	132	—		$V_{GS} = 0 \text{ V}, V_{DS} = 0 \text{ V to } 400 \text{ V}$	Note 3
C_{oss} Stored Energy	E_{oss}	—	15	—		$V_{DS} = 600 \text{ V}, f = 1 \text{ Mhz}$	Fig. 16
Turn-On Switching Energy (Body Diode)	E_{on}	—	110	—	μJ	$V_{DS} = 400 \text{ V}, V_{GS} = -4 \text{ V}/15 \text{ V}, I_D = 13.2 \text{ A},$ $R_{G(ext)} = 2.5 \Omega, L = 135 \mu\text{H}, T_J = 175^\circ\text{C}$ FWD = Internal Body Diode of MOSFET	Fig. 25
Turn Off Switching Energy (Body Diode)	E_{off}	—	22	—			
Turn-On Switching Energy (External Sic Diode)	E_{on}	—	63	—			
Turn Off Switching Energy (External Sic Diode)	E_{off}	—	28	—			
Turn-On Delay Time	$t_{d(on)}$	—	9	—	ns	$V_{DD} = 400 \text{ V}, V_{GS} = -4 \text{ V}/15 \text{ V}$ $I_D = 13.2 \text{ A}, R_{G(ext)} = 2.5 \Omega,$ $L = 135 \mu\text{H}$ Timing relative to V_{DS} Inductive load	Fig. 26
Rise Time	t_r	—	20	—			
Turn-Off Delay Time	$t_{d(off)}$	—	17	—			
Fall Time	t_f	—	8	—			
Internal Gate Resistance	$R_{G(int)}$	—	3	—	Ω	$f = 1 \text{ MHz}, V_{AC} = 25 \text{ mV}$	
Gate to Source Charge	Q_{gs}	—	14	—	nC	$V_{DS} = 400 \text{ V}, V_{GS} = -4 \text{ V}/15 \text{ V}$ $I_D = 13.2 \text{ A}$ Per IEC60747-8-4 pg 21	Fig. 12
Gate to Drain Charge	Q_{gd}	—		—			
Total Gate Charge	Q_g	—		46			

Note:

³ $C_{o(er)}$, a lumped capacitance that gives same stored energy as C_{oss} while V_{DS} is rising from 0 to 400V

$C_{o(tr)}$, a lumped capacitance that gives same charging time as C_{oss} while V_{DS} is rising from 0 to 400V



Reverse Diode Characteristics ($T_c = 25^\circ\text{C}$ unless otherwise specified)

Parameter	Symbol	Typ.	Max.	Unit	Test Conditions	Notes
Diode Forward Voltage	V_{SD}	5.1	—	V	$V_{GS} = -4\text{ V}, I_{SD} = 6.6\text{ A}, T_J = 25^\circ\text{C}$	Fig. 8, 9, 10
		4.8	—		$V_{GS} = -4\text{ V}, I_{SD} = 6.6\text{ A}, T_J = 175^\circ\text{C}$	
Continuous Diode Forward Current	I_S	—	23	A	$V_{GS} = -4\text{ V}, T_c = 25^\circ\text{C}$	
Diode pulse Current	$I_{S, pulse}$	—	99		$V_{GS} = -4\text{ V}$, pulse width t_p limited by T_{Jmax}	
Reverse Recovery Time	t_{rr}	20	—	ns	$V_{GS} = -4\text{ V}, I_{SD} = 13.2\text{ A}, V_R = 400\text{ V}$ $di_f/dt = 1200\text{ A}/\mu\text{s}, T_J = 175^\circ\text{C}$	
Reverse Recovery Charge	Q_{rr}	190	—	nC		
Peak Reverse Recovery Current	I_{RRM}	16	—	A		
Reverse Recovery Time	t_{rr}	29	—	ns	$V_{GS} = -4\text{ V}, I_{SD} = 13.2\text{ A}, V_R = 400\text{ V}$ $di_f/dt = 750\text{ A}/\mu\text{s}, T_J = 175^\circ\text{C}$	
Reverse Recovery Charge	Q_{rr}	181	—	nC		
Peak Reverse Recovery Current	I_{RRM}	9	—	A		

Thermal Characteristics

Parameter	Symbol	Typ.	Unit	Note
Thermal Resistance from Junction to Case	$R_{\theta JC}$	0.99	$^\circ\text{C}/\text{W}$	Fig. 21
Thermal Resistance From Junction to Ambient	$R_{\theta JA}$	40		



Typical Performance

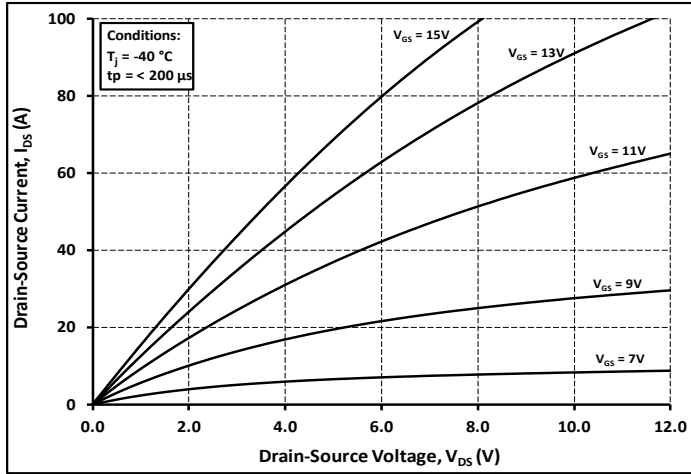

Figure 1. Output Characteristics $T_j = -40^\circ\text{C}$

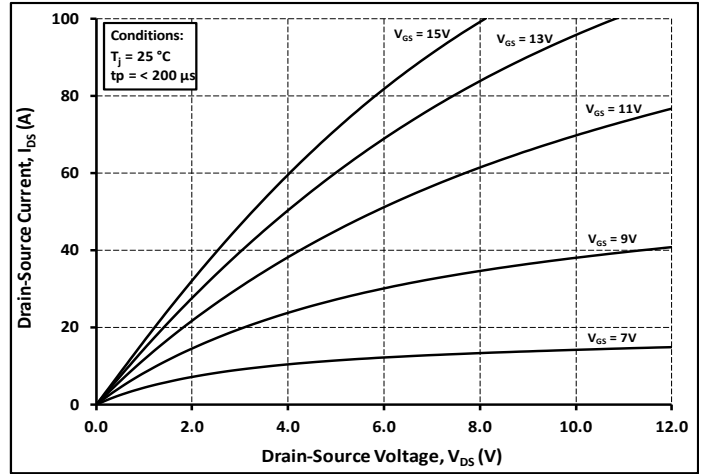

Figure 2. Output Characteristics $T_j = 25^\circ\text{C}$

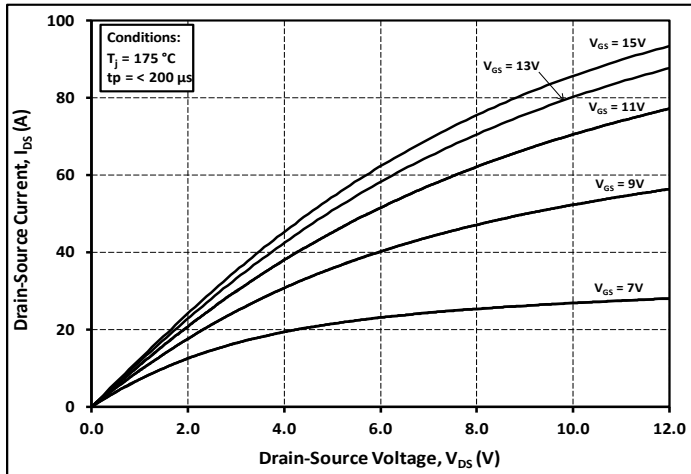

Figure 3. Output Characteristics $T_j = 175^\circ\text{C}$

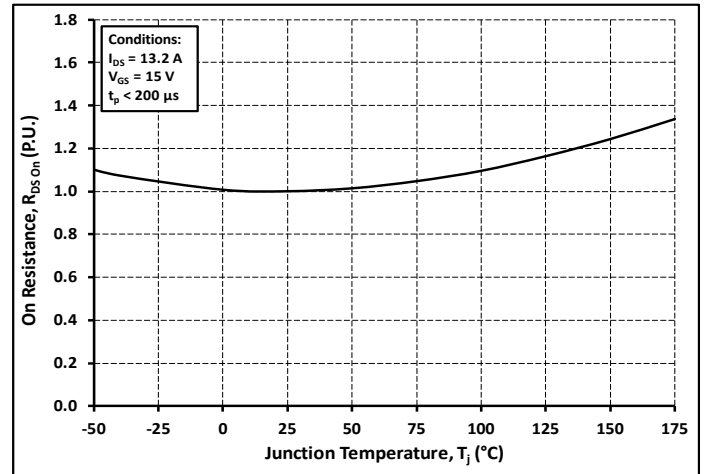

Figure 4. Normalized On-Resistance vs. Temperature

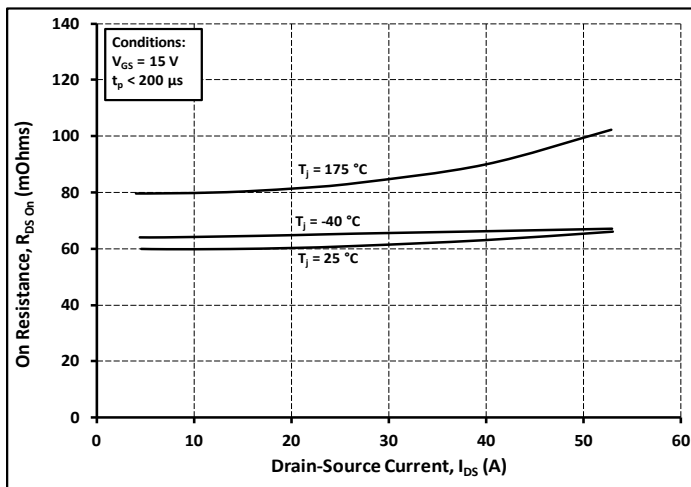

Figure 5. On-Resistance vs. Drain Current For Various Temperatures

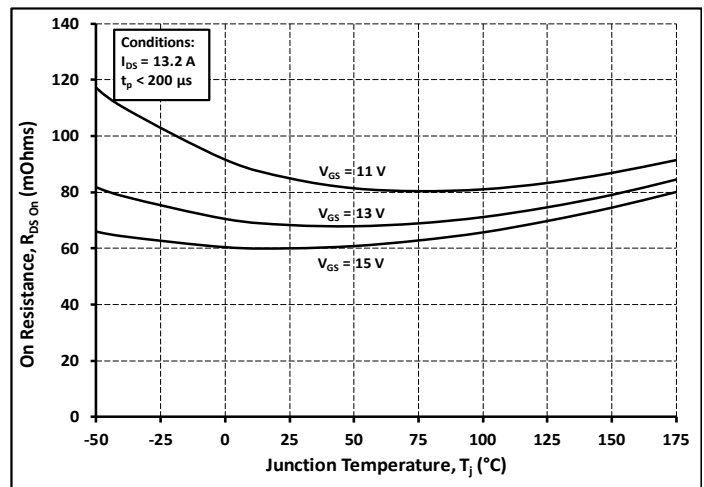

Figure 6. On-Resistance vs. Temperature For Various Gate Voltage



Typical Performance

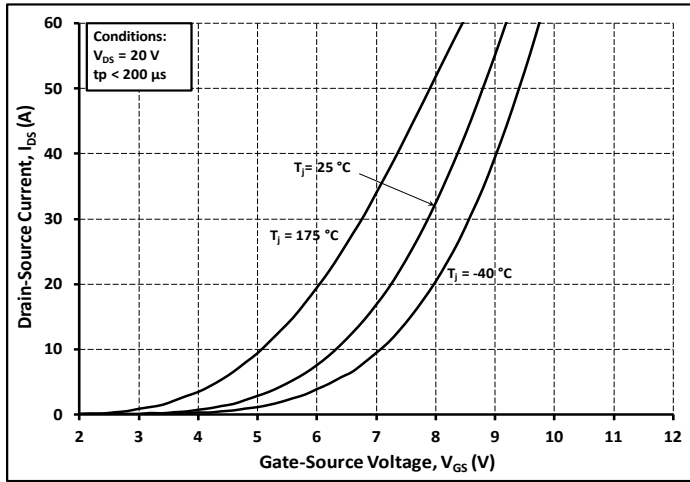

Figure 7. Transfer Characteristic for Various Junction Temperatures

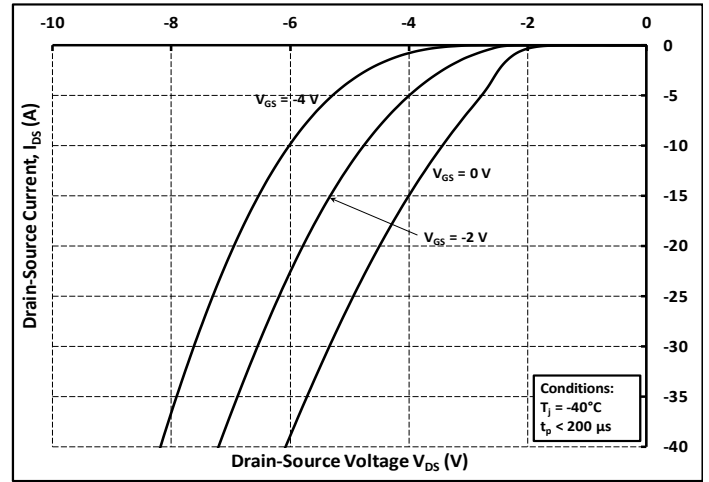

Figure 8. Body Diode Characteristic at -40°C

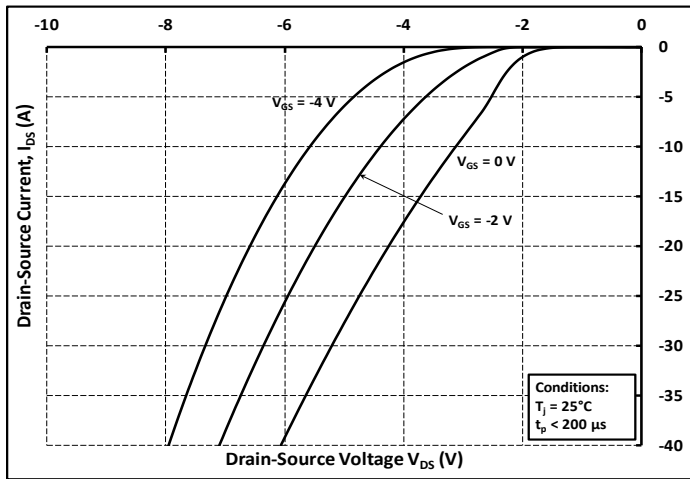

Figure 9. Body Diode Characteristic at 25°C

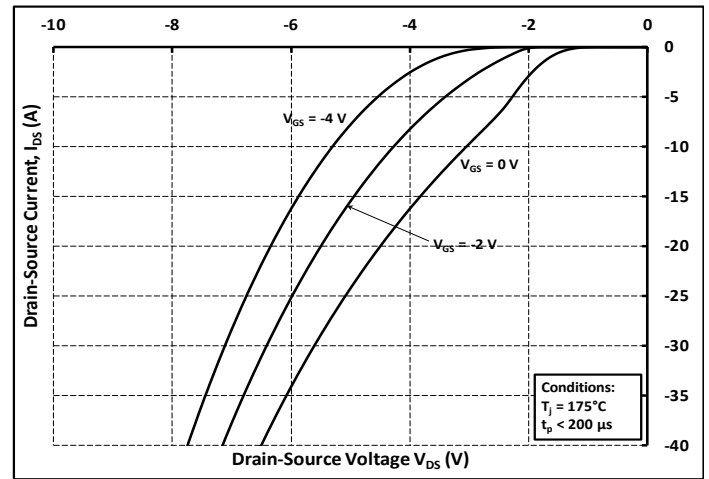

Figure 10. Body Diode Characteristic at 175°C

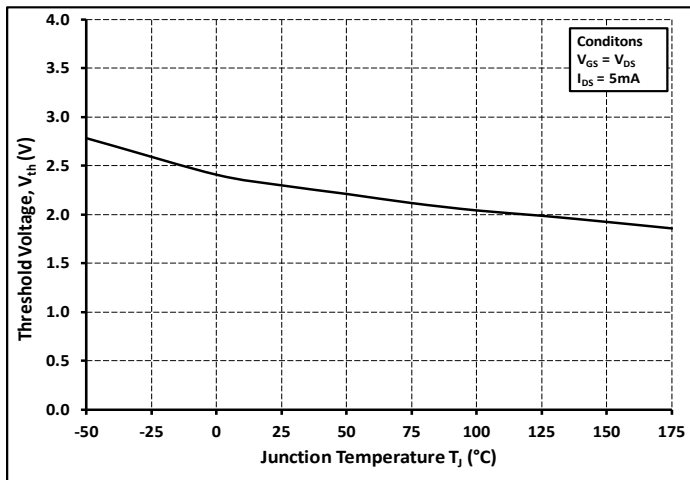

Figure 11. Threshold Voltage vs. Temperature

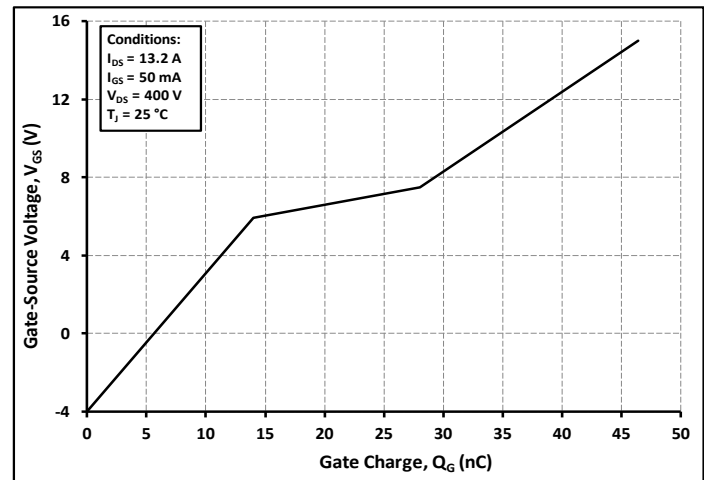

Figure 12. Gate Charge Characteristics



Typical Performance

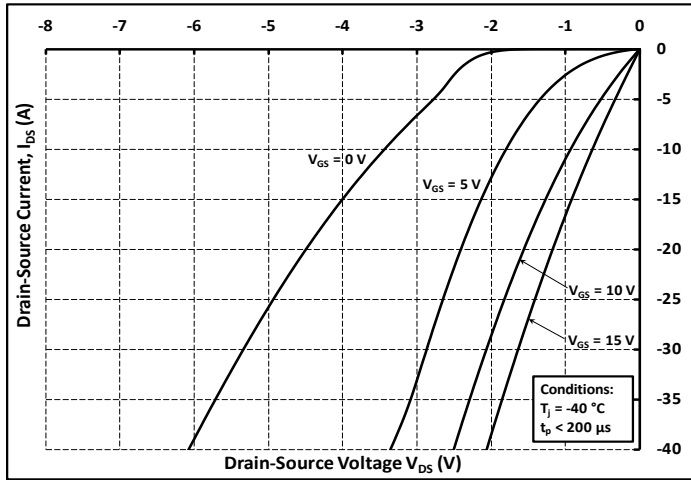

Figure 13. 3rd Quadrant Characteristic at -40°C

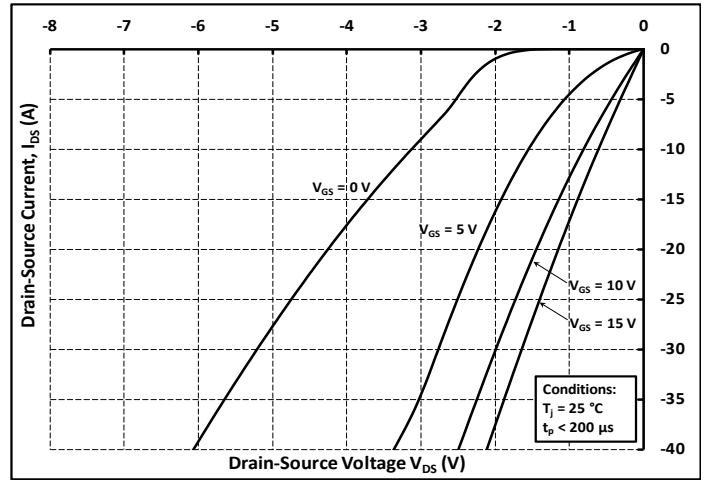

Figure 14. 3rd Quadrant Characteristic at 25°C

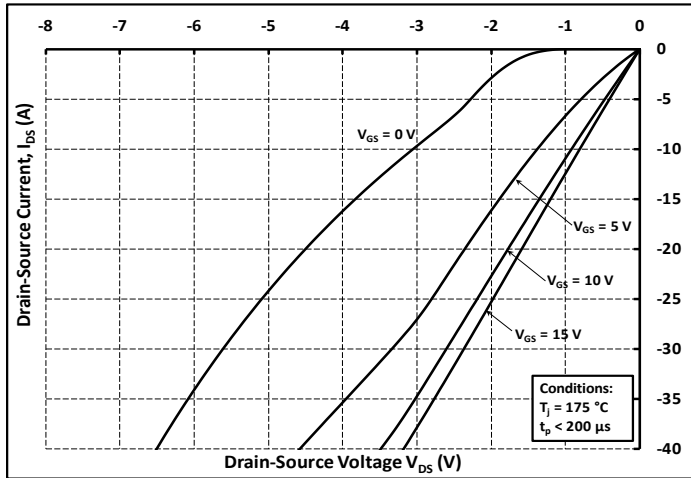

Figure 15. 3rd Quadrant Characteristic at 175°C

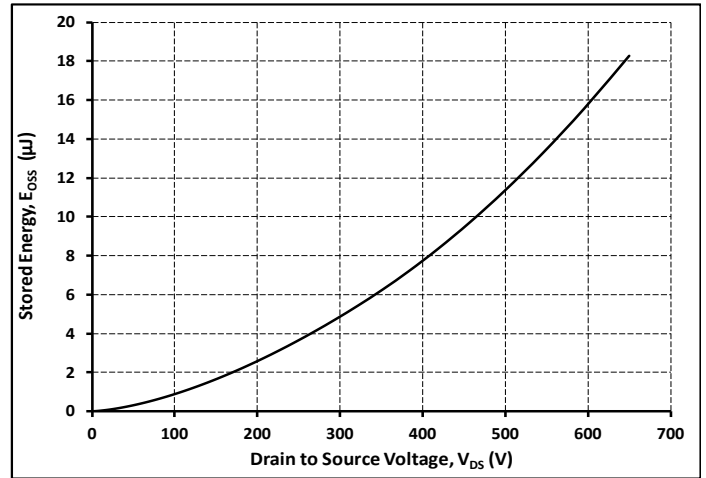

Figure 16. Output Capacitor Stored Energy

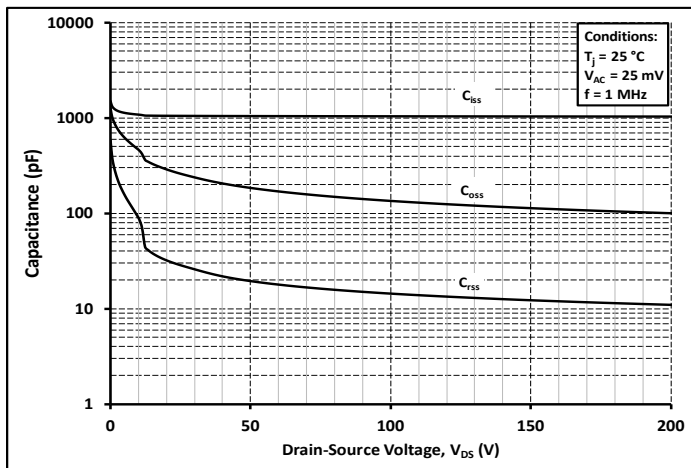

Figure 17. Capacitances vs. Drain-Source Voltage (0 - 200V)

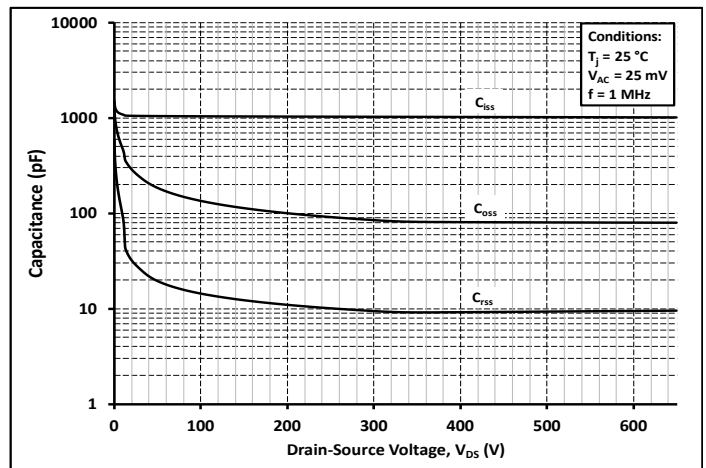

Figure 18. Capacitances vs. Drain-Source Voltage (0 - 650V)



Typical Performance

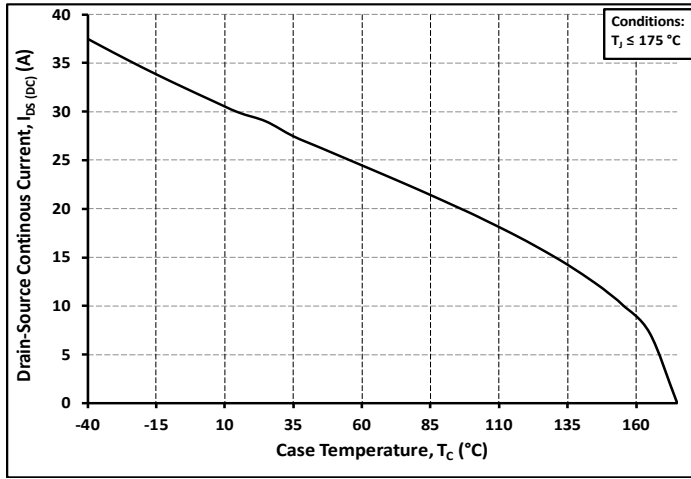

Figure 19. Continuous Drain Current Derating vs. Case Temperature

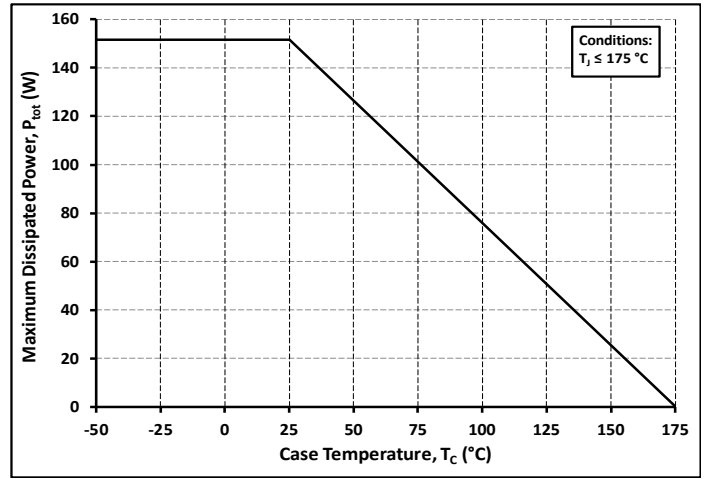

Figure 20. Maximum Power Dissipation Derating vs. Case Temperature

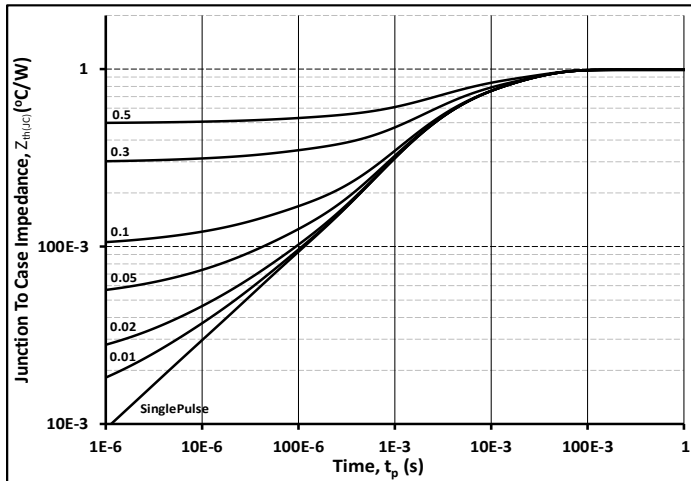

Figure 21. Transient Thermal Impedance (Junction - Case)

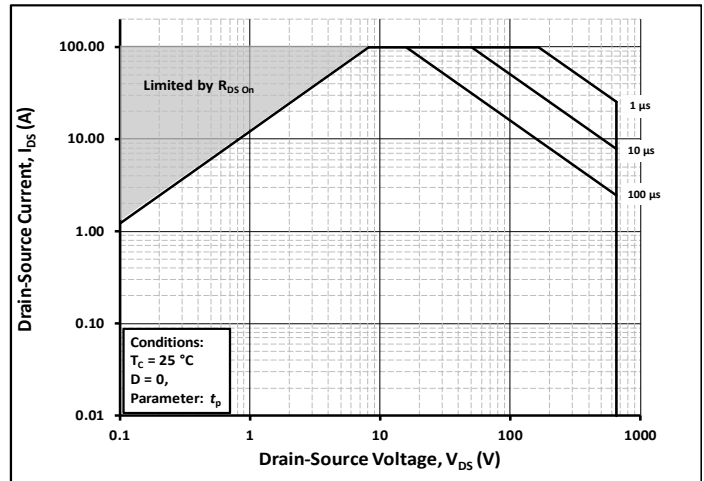

Figure 22. Safe Operating Area

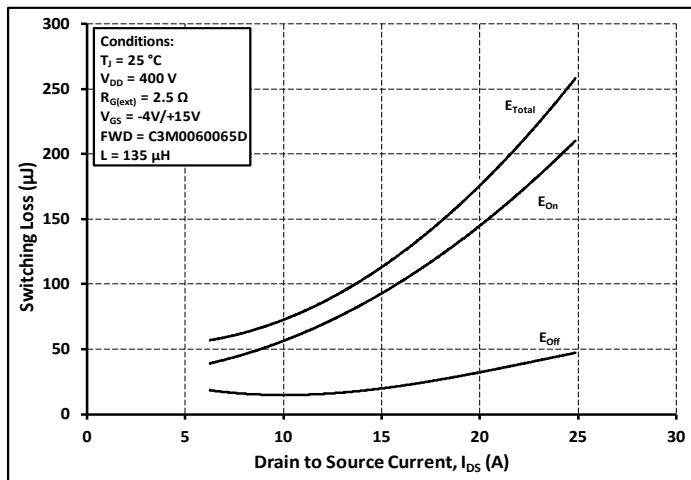

Figure 23. Clamped Inductive Switching Energy vs. Drain Current ($V_{DD} = 400V$)

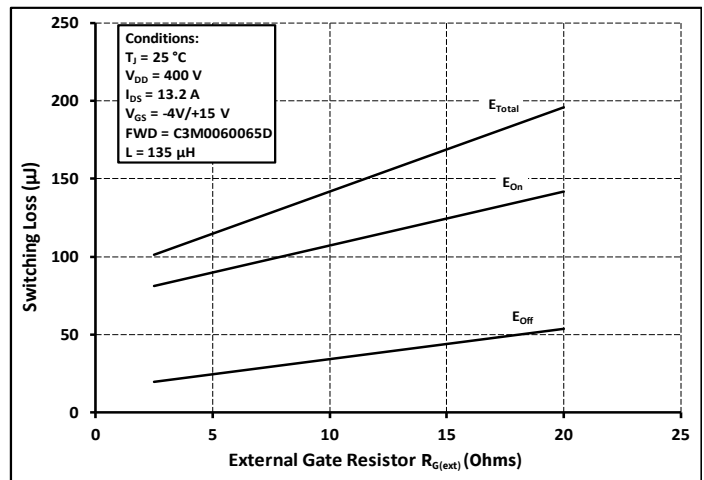

Figure 24. Clamped Inductive Switching Energy vs. $R_{G(ext)}$



Typical Performance

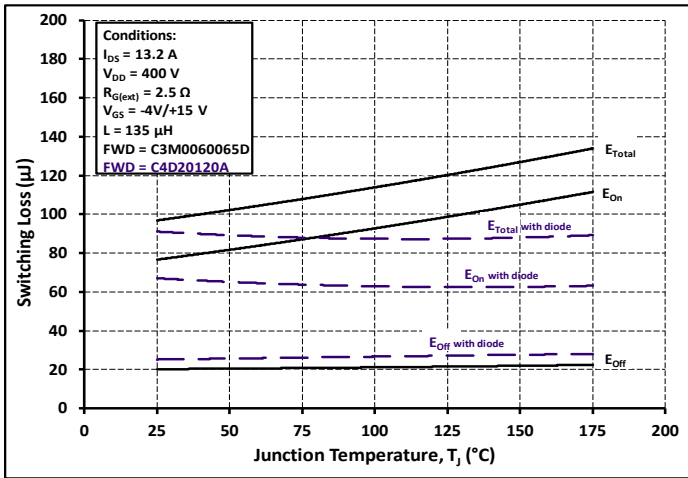

Figure 25. Clamped Inductive Switching Energy vs. Temperature

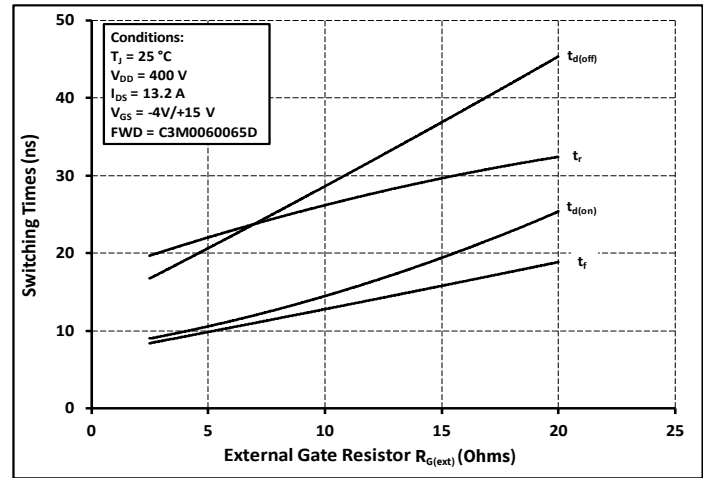

Figure 26. Switching Times vs. $R_{G(ext)}$

Test Circuit Schematic

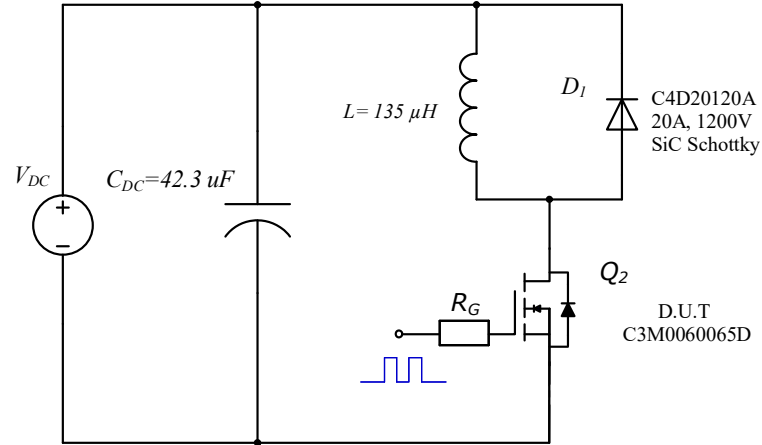

Figure 27. Clamped Inductive Switching Waveform Test Circuit

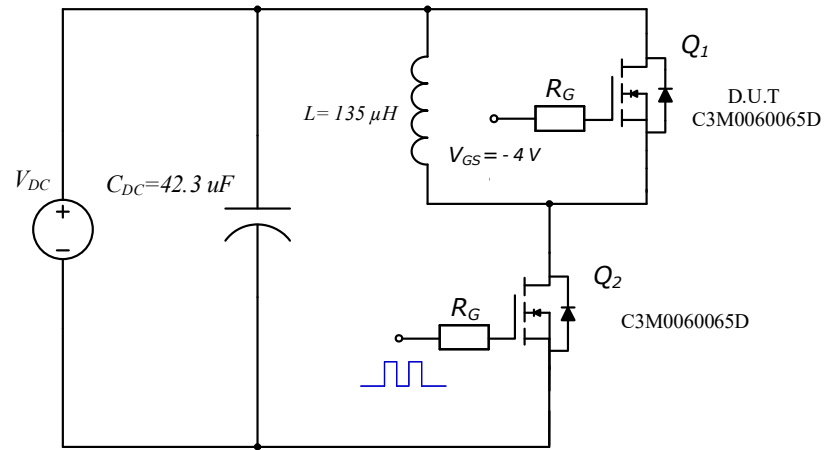
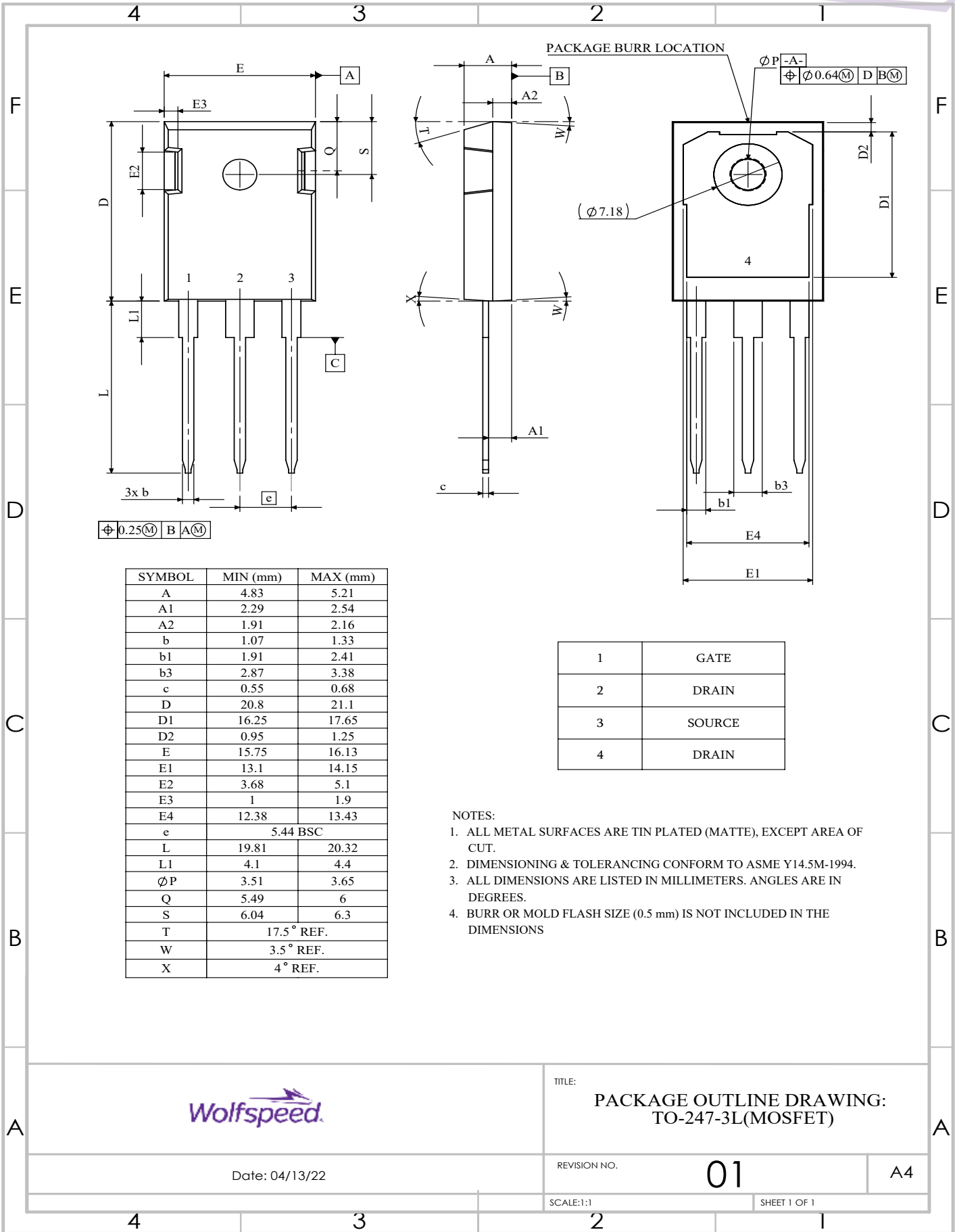

Figure 28. Body Diode Recovery Test Circuit

Package Dimensions – Package TO-247-3



$\phi 0.25(M) B A(M)$

SYMBOL	MIN (mm)	MAX (mm)
A	4.83	5.21
A1	2.29	2.54
A2	1.91	2.16
b	1.07	1.33
b1	1.91	2.41
b3	2.87	3.38
c	0.55	0.68
D	20.8	21.1
D1	16.25	17.65
D2	0.95	1.25
E	15.75	16.13
E1	13.1	14.15
E2	3.68	5.1
E3	1	1.9
E4	12.38	13.43
e	5.44 BSC	
L	19.81	20.32
L1	4.1	4.4
ØP	3.51	3.65
Q	5.49	6
S	6.04	6.3
T	17.5° REF.	
W	3.5° REF.	
X	4° REF.	

1	GATE
2	DRAIN
3	SOURCE
4	DRAIN

- NOTES:
1. ALL METAL SURFACES ARE TIN PLATED (MATTE), EXCEPT AREA OF CUT.
 2. DIMENSIONING & TOLERANCING CONFORM TO ASME Y14.5M-1994.
 3. ALL DIMENSIONS ARE LISTED IN MILLIMETERS. ANGLES ARE IN DEGREES.
 4. BURR OR MOLD FLASH SIZE (0.5 mm) IS NOT INCLUDED IN THE DIMENSIONS



TITLE:
PACKAGE OUTLINE DRAWING:
TO-247-3L(MOSFET)

Date: 04/13/22

REVISION NO. **01** A4

SCALE:1:1 SHEET 1 OF 1



Recommended Solder Pad Layout

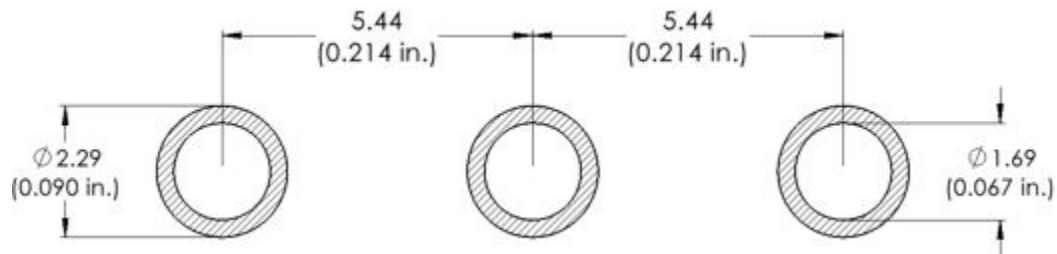

Revision History

Current Revision	Date of Release	Description of Changes
4	February-2021	N/A
5	November-2023	Not Released
6	January-2024	Updated Wolfstreak branding, package drawing, package image, and solder pad layout, added Revision History Table, Table 1 layout revised

Related Links

- [SPICE Models](#)
- [SiC MOSFET Isolated Gate Driver reference design](#)
- [SiC MOSFET Evaluation Board](#)



Notes & Disclaimer

This document and the information contained herein are subject to change without notice. Any such change shall be evidenced by the publication of an updated version of this document by Wolfspeed. No communication from any employee or agent of Wolfspeed or any third party shall effect an amendment or modification of this document. No responsibility is assumed by Wolfspeed for any infringement of patents or other rights of third parties which may result from use of the information contained herein. No license is granted by implication or otherwise under any patent or patent rights of Wolfspeed.

Notwithstanding any application-specific information, guidance, assistance, or support that Wolfspeed may provide, the buyer of this product is solely responsible for determining the suitability of this product for the buyer's purposes, including without limitation for use in the applications identified in the next bullet point, and for the compliance of the buyers' products, including those that incorporate this product, with all applicable legal, regulatory, and safety-related requirements.

This product has not been designed or tested for use in, and is not intended for use in, applications in which failure of the product would reasonably be expected to cause death, personal injury, or property damage, including but not limited to equipment implanted into the human body, life-support machines, cardiac defibrillators, and similar emergency medical equipment, aircraft navigation, communication, and control systems, aircraft power and propulsion systems, air traffic control systems, and equipment used in the planning, construction, maintenance, or operation of nuclear facilities.

The Silicon Carbide MOSFET module switches at speeds beyond what is customarily associated with IGBT-based modules. Therefore, special precautions are required to realize optimal performance. The interconnection between the gate driver and module housing needs to be as short as possible. This will afford optimal switching time and avoid the potential for device oscillation. Also, great care is required to insure minimum inductance between the module and DC link capacitors to avoid excessive VDS overshoot.

RoHS Compliance

The levels of RoHS restricted materials in this product are below the maximum concentration values (also referred to as the threshold limits) permitted for such substances, or are used in an exempted application, in accordance with EU Directive 2011/65/EC (RoHS2), as implemented January 2, 2013. RoHS Declarations for this product can be obtained from your Wolfspeed representative or from the Product Documentation sections of www.wolfspeed.com.

REACH Compliance

REACH substances of high concern (SVHCs) information is available for this product. Since the European Chemical Agency (ECHA) has published notice of their intent to frequently revise the SVHC listing for the foreseeable future, please contact your Wolfspeed representative to ensure you get the most up-to-date REACH SVHC Declaration. REACH banned substance information (REACH Article 67) is also available upon request.

Contact info:

4600 Silicon Drive
Durham, NC 27703 USA
Tel: +1.919.313.5300
www.wolfspeed.com/power