

DO NOT SCALE DRAWING

REVISIONS

ZONE	REV.	DESCRIPTION	DATE	APPROVED
	A	DRAWN	12-02-2015	

Body

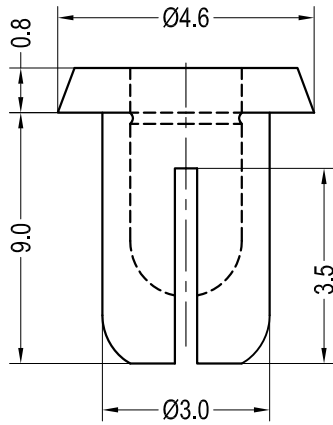

Pin

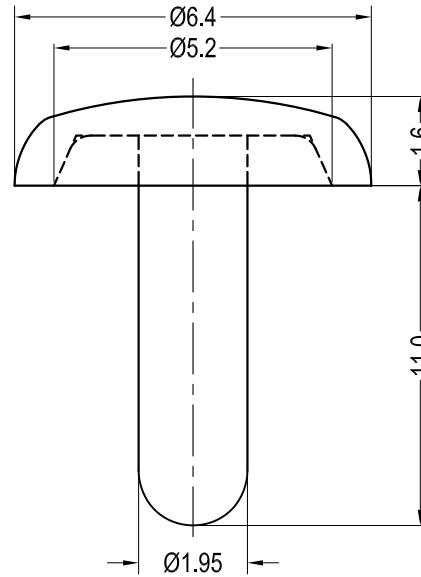

Assembly

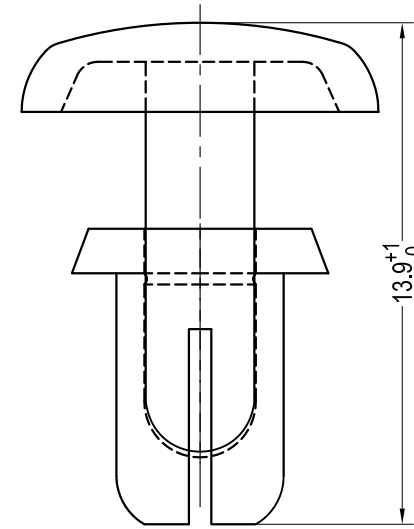

NOTES :

ALSO AVAILABLE IN FLAME RETARDANT NYLON (PA6 UL94V-0)
 Hole:Ø3.1-3.2mm; Panel Thickness:6.5-7.5mm



DESIGN RIGHT. TR FASTENINGS LTD. 2003
 UNDER NO CIRCUMSTANCES MUST THIS
 DRAWING BE COPIED OR DISCLOSED,
 WITHOUT FIRST OBTAINING WRITTEN
 AUTHORITY.

UNLESS OTHERWISE SPECIFIED:
 DIMENSIONS ARE IN MILLIMETERS.
 SURFACE FINISH:
 TOLERANCES:
 L≤4 = ±0.1 4<L≤15 = ±0.2
 15<L≤50 = ±0.3 50<L≤100 = ±0.4

NAME	DATE
DRAWN MARTIN ELLIOTT	12/02/2015
CHK'D	
APP'VD	

MATERIAL
 PA6 UL94V-2 RoHS COMPLIANT

HEAT TREATMENT
 N/A

FINISH
 BLACK OR WHITE

TITLE
 SNAP RIVET

CUSTOMER PART NO.

DWG NO.
 TRSR3090

A3