Description

The 74HCT00 provides provides four independent 2-input NAND gates with standard push-pull outputs. The device is designed for operation with a power supply range of 4.5V to 5.5V.

The gates perform the Boolean function:

$$Y = \overline{A \bullet B} \text{ or } Y = \overline{A} + \overline{B}$$

Features

- Wide Supply Voltage Range from 4.5V to 5.5V
- Pin Compatible with Low Power Schottky (LSTTL)
- Inputs Are TTL Voltage Level Compatible
- Sinks or sources 4mA at Vcc = 4.5V
- CMOS low power consumption
- Schmitt Trigger Action at All Inputs
- ESD Protection Exceeds JESD 22
 - 200-V Machine Model (A115-A)
 - 2000-V Human Body Model (A114-A)
 - Exceeds 1000-V Charged Device Model (C101C)
- Range of Package Options SO-14 and TSSOP-14
- **Totally Lead-Free & Fully RoHS Compliant (Notes 1 & 2)**
- **Halogen and Antimony Free. "Green" Device (Note 3)**

- Notes:
1. No purposely added lead. Fully EU Directive 2002/95/EC (RoHS) & 2011/65/EU (RoHS 2) compliant.
 2. See <http://www.diodes.com> for more information about Diodes Incorporated's definitions of Halogen- and Antimony-free, "Green" and Lead-free.
 3. Halogen- and Antimony-free "Green" products are defined as those which contain <900ppm bromine, <900ppm chlorine (<1500ppm total Br + Cl) and <1000ppm antimony compounds.

Pin Assignments

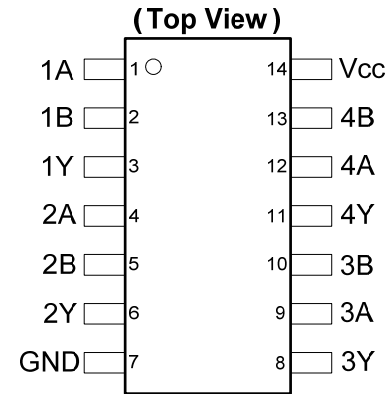

SO-14 / TSSOP-14

Applications

- General Purpose Logic
- Wide array of products such as:
 - PCs, networking, notebooks, netbooks
 - Computer peripherals, hard drives, CD/DVD ROM
 - TV, DVD, DVR, set top box

Pin Descriptions

| Pin Number | Pin Name | Function |
|------------|----------|----------------|
| 1 | 1A | Data Input |
| 2 | 1B | Data Input |
| 3 | 1Y | Data Output |
| 4 | 2A | Data Input |
| 5 | 2B | Data Input |
| 6 | 2Y | Data Output |
| 7 | GND | Ground |
| 8 | 3Y | Data Output |
| 9 | 3A | Data Input |
| 10 | 3B | Data Input |
| 11 | 4Y | Data Output |
| 12 | 4A | Data Input |
| 13 | 4B | Data Input |
| 14 | Vcc | Supply Voltage |

Logic Diagram

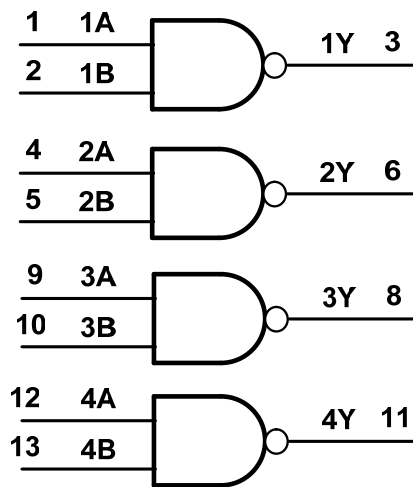

Function Table

| Inputs | | Output |
|--------|---|--------|
| A | B | Y |
| L | L | H |
| L | H | H |
| H | L | H |
| H | H | L |

Absolute Maximum Ratings (Note 4) (@T_A = +25°C, unless otherwise specified.)

| Symbol | Description | Rating | Unit |
|------------------|---|--------------|------|
| ESD HBM | Human Body Model ESD Protection | 2 | KV |
| ESD CDM | Charged Device Model ESD Protection | 1 | KV |
| ESD MM | Machine Model ESD Protection | 200 | V |
| V _{CC} | Supply Voltage Range | -0.5 to +7.0 | V |
| V _I | Input Voltage Range (Note 5) | -0.5 to +7.0 | V |
| I _{IK} | Input Clamp Current V _I < -0.5V or V _I > V _{CC} +0.5V | ±20 | mA |
| I _{OK} | Output Clamp Current V _O < -0.5V or V _O > V _{CC} +0.5V | ±20 | mA |
| I _O | Continuous Output Current -0.5V < V _O < V _{CC} +0.5V | +/- 25 | mA |
| I _{CC} | Continuous Current Through V _{CC} | 50 | mA |
| I _{GND} | Continuous Current Through GND | -50 | mA |
| T _J | Operating Junction Temperature | -40 to +150 | °C |
| T _{STG} | Storage Temperature | -65 to +150 | °C |
| P _{TOT} | Total Power Dissipation | 500 | mW |

- Notes: 4. Stresses beyond the absolute maximum may result in immediate failure or reduced reliability. These are stress values and device operation should be within recommend values.
5. Input Voltage cannot exceed V_{CC} to the extent the Maximum clamp current is exceeded.

Recommended Operating Conditions (Note 6) (@T_A = +25°C, unless otherwise specified.)

| Symbol | Parameter | Conditions | Min | Max | Unit |
|-----------------|------------------------------------|--------------------------------|-----|-----------------|------|
| V _{CC} | Supply Voltage | | 4.5 | 5.5 | V |
| V _I | Input Voltage | | 0 | V _{CC} | V |
| V _O | Output Voltage | | 0 | V _{CC} | V |
| Δt/ΔV | Input Transition Rise or Fall Rate | V _{CC} = 4.5V to 5.5V | | 500 | ns/V |
| T _A | Operating Free-Air Temperature | | -40 | +125 | °C |

Note: 6. Unused inputs should be held at V_{CC} or Ground.

Electrical Characteristics (@T_A = +25°C, unless otherwise specified.)

| Symbol | Parameter | Test Conditions | V _{CC} | T _A = -40°C to +85°C | | T _A = -40°C to +125°C | | Unit |
|------------------|---------------------------|--|-----------------|---------------------------------|------|----------------------------------|-----|------|
| | | | | Min | Max | Min | Max | |
| V _{IH} | High-level Input Voltage | | 4.5V to 5.5V | 2.0 | | 2.0 | | V |
| V _{IL} | Low-level Input Voltage | | 4.5V to 5.5V | | 0.8 | | 0.8 | V |
| V _{OH} | High-level Output Voltage | I _{OH} = -20μA | 4.5V | 4.4 | | 4.4 | | V |
| | | I _{OH} = -4mA | 4.5V | 3.84 | | 3.70 | | |
| V _{OL} | Low-level Output Voltage | I _{OL} = 20μA | 4.5V | | 0.1 | | 0.1 | V |
| | | I _{OL} = 4.0mA | 4.5V | | 0.33 | | 0.4 | |
| I _I | Input Current | V _I = GND to 6.0V | 6.0V | | ± 1 | | ± 1 | μA |
| I _{CC} | Supply Current | V _I = GND or V _{CC} , I _O = 0 | 6.0V | | 20 | | 40 | μA |
| ΔI _{CC} | Additional Supply Current | One Input at V _{CC} -2.1V Other pins at V _{CC} or GND | 4.5V to 5.5V | | 675 | | 735 | μA |

Switching Characteristics

| Symbol | Parameter | Test Conditions | V _{CC} | T _A = +25°C | | | -40°C to +85°C | -40°C to +125°C | Unit |
|-----------------|--|-----------------------------------|-----------------|------------------------|-----|-----|----------------|-----------------|------|
| | | | | Min | Typ | Max | Max | Max | |
| t _{PD} | Propagation Delay A _N to Y _N | Figure 1 C _L = 50pF | 4.5V | — | 12 | 22 | 24 | 29 | ns |
| t _t | Transition Time | Figure 1 C _L = 50pF | 4.5V | — | 7 | 22 | 22 | 29 | ns |

Operating Characteristics (@T_A = +25°C, unless otherwise specified.)

| Parameter | | Test Conditions | V _{CC} = 5.5V | Unit |
|-----------------|--|---|------------------------|------|
| | | | Typ | |
| C _{pd} | Power Dissipation Capacitance per Gate | f = 1 MHz | 12 | pF |
| C _i | Input Capacitance | V _i = V _{CC} – or GND | 3.5 | pF |

Parameter Measurement Information

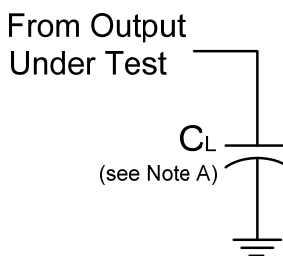

| V _{CC} | Inputs | | V _M | C _L |
|-----------------|----------------|--------------------------------|----------------|--------------------|
| | V _i | t _r /t _f | | |
| 4.5V | 3.0V | 3ns | 1.5V | V _{OH} /2 |

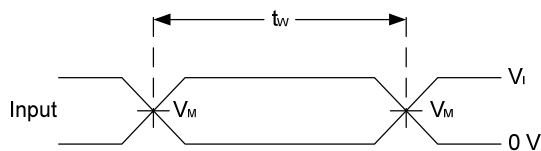

**Voltage Waveform
Pulse Duration**

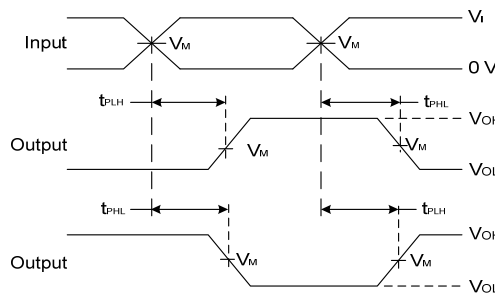

**Voltage Waveform
Propagation Delay Times
Inverting and Non Inverting Outputs**

- Notes:
- A. Includes test lead and test apparatus capacitance.
 - B. All pulses are supplied at pulse repetition rate ≤ 1 MHz.
 - C. Inputs are measured separately one transition per measurement.
 - D. t_{PLH} and t_{PHL} are the same as t_{PD}.

Figure 1 Load Circuit and Voltage Waveforms

Ordering Information

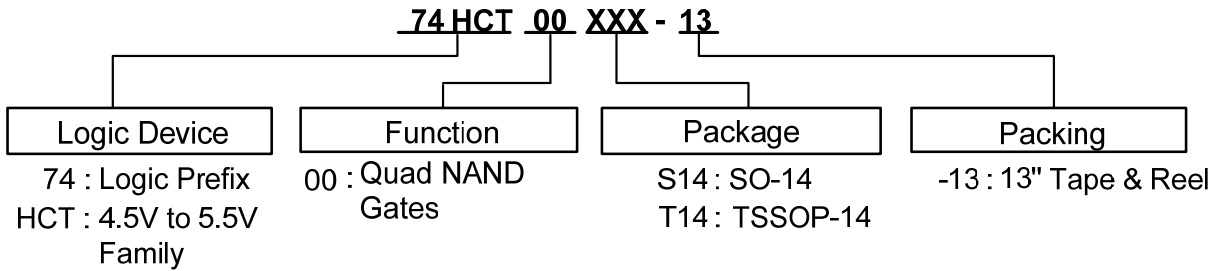

| Device | Package Code | Packaging | 7" Tape and Reel | |
|---------------|--------------|-----------|------------------|--------------------|
| | | | Quantity | Part Number Suffix |
| 74HCT00S14-13 | S14 | SO-14 | 2500/Tape & Reel | -13 |
| 74HCT00T14-13 | T14 | TSSOP-14 | 2500/Tape & Reel | -13 |

Marking Information

(1) SO-14, TSSOP-14

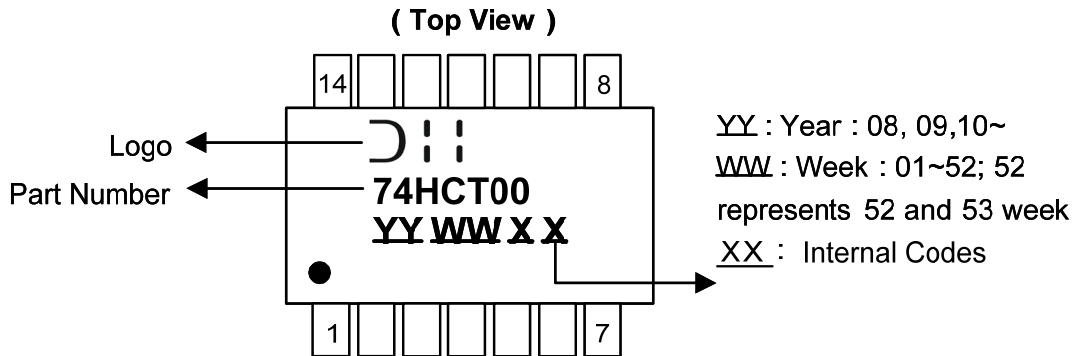

| Part Number | Package |
|-------------|----------|
| 74HCT00S14 | SO-14 |
| 74HCT00T14 | TSSOP-14 |

Package Outline Dimensions (All dimensions in mm.)

Please see AP02002 at <http://www.diodes.com/datasheets/ap02002.pdf> for latest version.

Package Type: SO-14

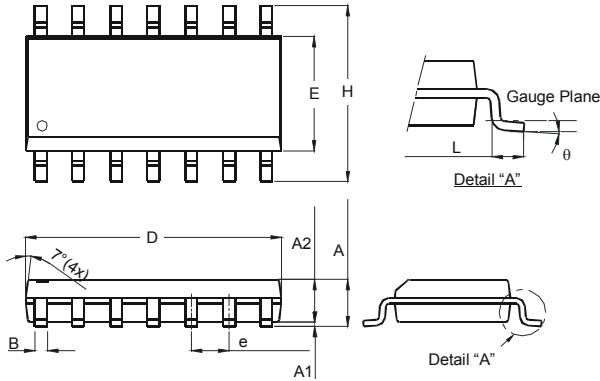

| SO-14 | | |
|-----------------------------|----------|------|
| Dim | Min | Max |
| A | 1.47 | 1.73 |
| A1 | 0.10 | 0.25 |
| A2 | 1.45 Typ | |
| B | 0.33 | 0.51 |
| D | 8.53 | 8.74 |
| E | 3.80 | 3.99 |
| e | 1.27 Typ | |
| H | 5.80 | 6.20 |
| L | 0.38 | 1.27 |
| θ | 0° | 8° |
| All Dimensions in mm | | |

Package Type: TSSOP-14

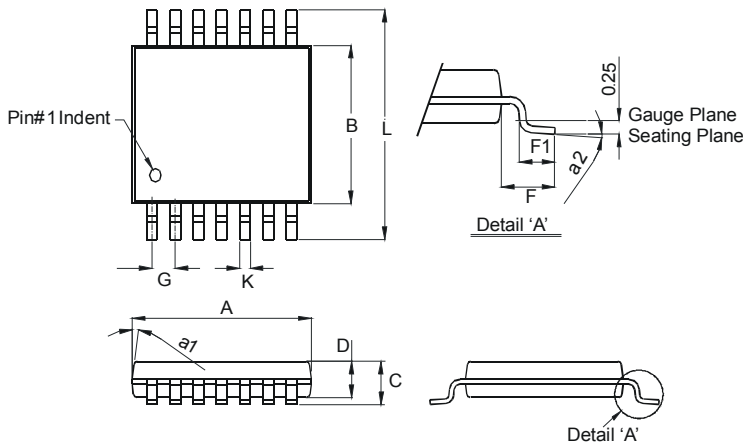

| TSSOP-14 | | |
|-----------------------------|----------|------|
| Dim | Min | Max |
| a1 | 7° (4X) | |
| a2 | 0° | 8° |
| A | 4.9 | 5.10 |
| B | 4.30 | 4.50 |
| C | — | 1.2 |
| D | 0.8 | 1.05 |
| F | 1.00 Typ | |
| F1 | 0.45 | 0.75 |
| G | 0.65 Typ | |
| K | 0.19 | 0.30 |
| L | 6.40 Typ | |
| All Dimensions in mm | | |

Suggested Pad Layout

Please see AP02001 at <http://www.diodes.com/datasheets/ap02001.pdf> for latest version.

Package Type: SO-14

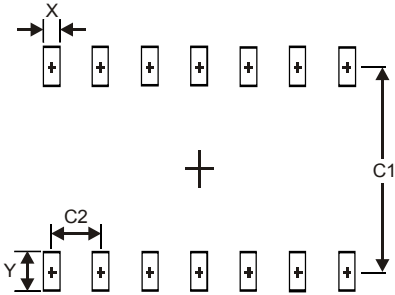

| Dimensions | Value (in mm) |
|------------|---------------|
| X | 0.60 |
| Y | 1.50 |
| C1 | 5.4 |
| C2 | 1.27 |

Package Type: TSSOP-14

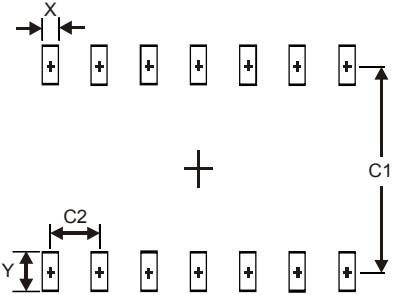

| Dimensions | Value (in mm) |
|------------|---------------|
| X | 0.45 |
| Y | 1.45 |
| C1 | 5.9 |
| C2 | 0.65 |

IMPORTANT NOTICE

DIODES INCORPORATED MAKES NO WARRANTY OF ANY KIND, EXPRESS OR IMPLIED, WITH REGARDS TO THIS DOCUMENT, INCLUDING, BUT NOT LIMITED TO, THE IMPLIED WARRANTIES OF MERCHANTABILITY AND FITNESS FOR A PARTICULAR PURPOSE (AND THEIR EQUIVALENTS UNDER THE LAWS OF ANY JURISDICTION).

Diodes Incorporated and its subsidiaries reserve the right to make modifications, enhancements, improvements, corrections or other changes without further notice to this document and any product described herein. Diodes Incorporated does not assume any liability arising out of the application or use of this document or any product described herein; neither does Diodes Incorporated convey any license under its patent or trademark rights, nor the rights of others. Any Customer or user of this document or products described herein in such applications shall assume all risks of such use and will agree to hold Diodes Incorporated and all the companies whose products are represented on Diodes Incorporated website, harmless against all damages.

Diodes Incorporated does not warrant or accept any liability whatsoever in respect of any products purchased through unauthorized sales channel. Should Customers purchase or use Diodes Incorporated products for any unintended or unauthorized application, Customers shall indemnify and hold Diodes Incorporated and its representatives harmless against all claims, damages, expenses, and attorney fees arising out of, directly or indirectly, any claim of personal injury or death associated with such unintended or unauthorized application.

Products described herein may be covered by one or more United States, international or foreign patents pending. Product names and markings noted herein may also be covered by one or more United States, international or foreign trademarks.

This document is written in English but may be translated into multiple languages for reference. Only the English version of this document is the final and determinative format released by Diodes Incorporated.

LIFE SUPPORT

Diodes Incorporated products are specifically not authorized for use as critical components in life support devices or systems without the express written approval of the Chief Executive Officer of Diodes Incorporated. As used herein:

A. Life support devices or systems are devices or systems which:

1. are intended to implant into the body, or
2. support or sustain life and whose failure to perform when properly used in accordance with instructions for use provided in the labeling can be reasonably expected to result in significant injury to the user.

B. A critical component is any component in a life support device or system whose failure to perform can be reasonably expected to cause the failure of the life support device or to affect its safety or effectiveness.

Customers represent that they have all necessary expertise in the safety and regulatory ramifications of their life support devices or systems, and acknowledge and agree that they are solely responsible for all legal, regulatory and safety-related requirements concerning their products and any use of Diodes Incorporated products in such safety-critical, life support devices or systems, notwithstanding any devices- or systems-related information or support that may be provided by Diodes Incorporated. Further, Customers must fully indemnify Diodes Incorporated and its representatives against any damages arising out of the use of Diodes Incorporated products in such safety-critical, life support devices or systems.

Copyright © 2013, Diodes Incorporated

www.diodes.com