



16-Bit 28-Pin Starter Development Board User's Guide

Note the following details of the code protection feature on Microchip devices:

- Microchip products meet the specification contained in their particular Microchip Data Sheet.
- Microchip believes that its family of products is one of the most secure families of its kind on the market today, when used in the intended manner and under normal conditions.
- There are dishonest and possibly illegal methods used to breach the code protection feature. All of these methods, to our knowledge, require using the Microchip products in a manner outside the operating specifications contained in Microchip's Data Sheets. Most likely, the person doing so is engaged in theft of intellectual property.
- Microchip is willing to work with the customer who is concerned about the integrity of their code.
- Neither Microchip nor any other semiconductor manufacturer can guarantee the security of their code. Code protection does not mean that we are guaranteeing the product as "unbreakable."

Code protection is constantly evolving. We at Microchip are committed to continuously improving the code protection features of our products. Attempts to break Microchip's code protection feature may be a violation of the Digital Millennium Copyright Act. If such acts allow unauthorized access to your software or other copyrighted work, you may have a right to sue for relief under that Act.

Information contained in this publication regarding device applications and the like is provided only for your convenience and may be superseded by updates. It is your responsibility to ensure that your application meets with your specifications. MICROCHIP MAKES NO REPRESENTATIONS OR WARRANTIES OF ANY KIND WHETHER EXPRESS OR IMPLIED, WRITTEN OR ORAL, STATUTORY OR OTHERWISE, RELATED TO THE INFORMATION, INCLUDING BUT NOT LIMITED TO ITS CONDITION, QUALITY, PERFORMANCE, MERCHANTABILITY OR FITNESS FOR PURPOSE. Microchip disclaims all liability arising from this information and its use. Use of Microchip devices in life support and/or safety applications is entirely at the buyer's risk, and the buyer agrees to defend, indemnify and hold harmless Microchip from any and all damages, claims, suits, or expenses resulting from such use. No licenses are conveyed, implicitly or otherwise, under any Microchip intellectual property rights.

Trademarks

The Microchip name and logo, the Microchip logo, Accuron, dsPIC, KEELOQ, KEELOQ logo, microID, MPLAB, PIC, PICmicro, PICSTART, PRO MATE, PowerSmart, rfPIC, and SmartShunt are registered trademarks of Microchip Technology Incorporated in the U.S.A. and other countries.

AmpLab, FilterLab, Linear Active Thermistor, Migratable Memory, MXDEV, MXLAB, PS logo, SEEVAL, SmartSensor and The Embedded Control Solutions Company are registered trademarks of Microchip Technology Incorporated in the U.S.A.

Analog-for-the-Digital Age, Application Maestro, CodeGuard, dsPICDEM, dsPICDEM.net, dsPICworks, ECAN, ECONOMONITOR, FanSense, FlexROM, fuzzyLAB, In-Circuit Serial Programming, ICSP, ICEPIC, Mindi, MiWi, MPASM, MPLAB Certified logo, MPLIB, MPLINK, PICkit, PICDEM, PICDEM.net, PICLAB, PICtail, PowerCal, PowerInfo, PowerMate, PowerTool, REAL ICE, rFLAB, rfPICDEM, Select Mode, Smart Serial, SmartTel, Total Endurance, UNI/O, WiperLock and ZENA are trademarks of Microchip Technology Incorporated in the U.S.A. and other countries.

SQTP is a service mark of Microchip Technology Incorporated in the U.S.A.

All other trademarks mentioned herein are property of their respective companies.

© 2007, Microchip Technology Incorporated, Printed in the U.S.A., All Rights Reserved.

 Printed on recycled paper.

Microchip received ISO/TS-16949:2002 certification for its worldwide headquarters, design and wafer fabrication facilities in Chandler and Tempe, Arizona, Gresham, Oregon and Mountain View, California. The Company's quality system processes and procedures are for its PIC[®] MCUs and dsPIC[®] DSCs, KEELOQ[®] code hopping devices, Serial EEPROMs, microperipherals, nonvolatile memory and analog products. In addition, Microchip's quality system for the design and manufacture of development systems is ISO 9001:2000 certified.

QUALITY MANAGEMENT SYSTEM
CERTIFIED BY DNV
== ISO/TS 16949:2002 ==

Table of Contents

Preface	1
Introduction.....	1
Document Layout	1
Conventions Used in this Guide	2
Warranty Registration.....	2
Recommended Reading.....	3
The Microchip Web Site	4
Development Systems Customer Change Notification Service	4
Customer Support	5
Document Revision History	5
 Chapter 1. Introduction	
1.1 Introduction	7
1.2 Development Kit Contents	8
1.3 Development Board Functionality and Features	9
1.4 Demonstration Program	9
1.5 Power Selection	9
1.6 UART Communication Via USB	10
1.7 Device Selection	10
1.8 On-board Peripheral Selection	10
 Chapter 2. Tutorial	
2.1 Introduction	11
2.2 Tutorial Overview	11
2.3 Equipment Needed	12
2.4 Creating the Project	12
2.5 Building the Code	17
2.6 Programming the Chip	18
2.7 Running the Application	23
2.8 Debugging the Code	24
2.9 Programming the Device for Stand-alone Operation	27
2.10 Summary	27
 Chapter 3. Demonstration Program	
3.1 Introduction	29
3.2 Demonstration Program Summary	29
3.3 Demonstration Program Description	29
3.4 Demonstration Program Setup	30

16-Bit 28-Pin Starter Development Board User's Guide

Chapter 4. Development Hardware

4.1 Introduction	33
4.2 Hardware Overview	33
4.3 Hardware Elements	34

Appendix A. Drawings and Schematics

A.1 Introduction	37
A.2 16-bit 28-Pin Starter Development Board Layout	37
A.3 16-bit 28-Pin Starter Development Board Schematics	38

Appendix B. Bill of Materials (BOM)

Index	43
--------------------	-----------

Worldwide Sales and Service	44
--	-----------

Preface

NOTICE TO CUSTOMERS

All documentation becomes dated, and this manual is no exception. Microchip tools and documentation are constantly evolving to meet customer needs, so some actual dialogs and/or tool descriptions may differ from those in this document. Please refer to our web site (www.microchip.com) to obtain the latest documentation available.

Documents are identified with a “DS” number. This number is located on the bottom of each page, in front of the page number. The numbering convention for the DS number is “DSXXXXA”, where “XXXX” is the document number and “A” is the revision level of the document.

For the most up-to-date information on development tools, see the MPLAB® IDE on-line help. Select the Help menu, and then Topics to open a list of available on-line help files.

INTRODUCTION

This chapter contains general information that will be useful to know before using the 16-Bit 28-Pin Starter Development Board. Items discussed in this chapter include:

- Document Layout
- Conventions Used in this Guide
- Warranty Registration
- Recommended Reading
- The Microchip Web Site
- Development Systems Customer Change Notification Service
- Customer Support
- Document Revision History

DOCUMENT LAYOUT

This document describes how to use the 16-Bit 28-Pin Starter Development Board as a development tool to emulate and debug firmware on a target board. The manual layout is as follows:

- **Chapter 1. Introduction** – Introduces the 16-Bit 28-Pin Starter Development Board and provides a brief description of the hardware.
- **Chapter 2. Tutorial** – Details the step-by-step process for getting the 16-Bit 28-Pin Starter Development Board up and running with the MPLAB® ICD 2 in-circuit debugger.
- **Chapter 3. Demonstration Program** – Describes the operational functionality of the sample code that is preprogrammed into the dsPIC33F device.
- **Chapter 4. Development Hardware** – Describes the hardware on the 16-Bit 28-Pin Starter Development Board.
- **Appendix A. Drawings and Schematics** – Provides a diagram of the hardware layout, and schematic diagrams for the 16-Bit 28-Pin Starter Development Board.
- **Appendix B. Bill of Materials (BOM)** – Lists the parts used in the 16-Bit 28-Pin Starter Development Board.

16-Bit 28-Pin Starter Development Board User's Guide

CONVENTIONS USED IN THIS GUIDE

This manual uses the following documentation conventions:

DOCUMENTATION CONVENTIONS

Description	Represents	Examples
Arial font:		
Italic characters	Referenced books	<i>MPLAB[®] IDE User's Guide</i>
	Emphasized text	...is the <i>only</i> compiler...
Initial caps	A window	the Output window
	A dialog	the Settings dialog
	A menu selection	select Enable Programmer
Quotes	A field name in a window or dialog	"Save project before build"
Underlined, italic text with right angle bracket	A menu path	<u><i>File</i></u> >Save
Bold characters	A dialog button	Click OK
	A tab	Click the Power tab
'bnnnn	A binary number where <i>n</i> is a digit	'b00100, 'b10
Text in angle brackets < >	A key on the keyboard	Press <Enter>, <F1>
Courier font:		
Plain Courier	Sample source code	#define START
	Filenames	autoexec.bat
	File paths	c:\mcc18\h
	Keywords	_asm, _endasm, static
	Command-line options	-Opa+, -Opa-
	Bit values	0, 1
Italic Courier	A variable argument	<i>file.o</i> , where <i>file</i> can be any valid filename
0xnnnn	A hexadecimal number where <i>n</i> is a hexadecimal digit	0xFFFF, 0x007A
Square brackets []	Optional arguments	mcc18 [options] <i>file</i> [options]
Curly brackets and pipe character: { }	Choice of mutually exclusive arguments; an OR selection	errorlevel {0 1}
Ellipses...	Replaces repeated text	var_name [, var_name...]
	Represents code supplied by user	void main (void) { ... }

WARRANTY REGISTRATION

Please complete the enclosed Warranty Registration Card and mail it promptly. Sending in the Warranty Registration Card entitles users to receive new product updates. Interim software releases are available at the Microchip web site.

RECOMMENDED READING

This user's guide describes how to use 16-Bit 28-Pin Starter Development Board. Other useful documents are listed below. The following Microchip documents are available and recommended as supplemental reference resources.

dsPIC30F Family Reference Manual (DS70046)

Consult this document for detailed information on dsPIC30F device operation. This reference manual explains the operation of the dsPIC30F DSC family architecture and peripheral modules, but does not cover the specifics of each device. Refer to the appropriate device data sheet for device-specific information.

dsPIC30F2010 Data Sheet (DS70118)

This data sheet summarizes the features of the dsPIC30F2010. It provides essential information needed to develop software for this device.

dsPIC30F/33F Programmer's Reference Manual (DS70157)

This manual is a software developer's reference for the dsPIC30F/33F 16-bit DSC family of devices. It describes the instruction set in detail and also provides general information to assist in developing software for the dsPIC30F/33F DSC family.

dsPIC33FJ12GP201/202 Data Sheet (DS70264)

This data sheet summarizes the features of the dsPIC33FJ12GP201/202. It provides essential information needed to develop software for these devices.

dsPIC33FJ12MC201/202 Data Sheet (DS70265)

This data sheet summarizes the features of the dsPIC33FJ12MC201/202. It provides essential information needed to develop software for these devices.

PIC24HJ12GP201/202 Data Sheet (DS70282)

This data sheet summarizes the features of the PIC24HJ12GP201/202. It provides essential information needed to develop software for these devices.

PIC24FJ64GA004 Data Sheet (DS39881)

This data sheet summarizes the features of the PIC24FJ64GA004. It provides essential information needed to develop software for this device.

MPLAB ASM30, MPLAB LINK30 and Utilities User's Guide (DS51317)

This document details Microchip Technology's language tools for dsPIC[®] DSC devices based on GNU technology. The language tools discussed are:

- MPLAB ASM30 Assembler
- MPLAB LINK30 Linker
- MPLAB LIB30 Archiver/Librarian
- Other Utilities

MPLAB C30 C Compiler User's Guide (DS51284)

This document details the use of Microchip's MPLAB C30 C Compiler for dsPIC DSC devices to develop an application. MPLAB C30 is a GNU-based language tool, based on source code from the Free Software Foundation (FSF). For more information about the FSF, see www.fsf.org.

Other GNU language tools available from Microchip are:

- MPLAB ASM30 Assembler
- MPLAB LINK30 Linker
- MPLAB LIB30 Librarian/Archiver

MPLAB IDE Simulator, Editor User's Guide (DS51025)

Consult this document for more information pertaining to the installation and implementation of the MPLAB Integrated Development Environment (IDE) Software.

To obtain any of these documents, visit the Microchip web site at www.microchip.com.

16-Bit 28-Pin Starter Development Board User's Guide

THE MICROCHIP WEB SITE

Microchip provides online support via our web site at www.microchip.com. This web site is used as a means to make files and information easily available to customers. Accessible by using your favorite Internet browser, the web site contains the following information:

- **Product Support** – Data sheets and errata, application notes and sample programs, design resources, user's guides and hardware support documents, latest software releases and archived software
- **General Technical Support** – Frequently Asked Questions (FAQs), technical support requests, online discussion groups, Microchip consultant program member listing
- **Business of Microchip** – Product selector and ordering guides, latest Microchip press releases, listing of seminars and events, listings of Microchip sales offices, distributors and factory representatives

DEVELOPMENT SYSTEMS CUSTOMER CHANGE NOTIFICATION SERVICE

Microchip's customer notification service helps keep customers current on Microchip products. Subscribers will receive e-mail notification whenever there are changes, updates, revisions or errata related to a specified product family or development tool of interest.

To register, access the Microchip web site at www.microchip.com, click on Customer Change Notification and follow the registration instructions.

The Development Systems product group categories are:

- **Compilers** – The latest information on Microchip C compilers and other language tools. These include the MPLAB C18 and MPLAB C30 C compilers; MPASM™ and MPLAB ASM30 assemblers; MPLINK™ and MPLAB LINK30 object linkers; and MPLIB™ and MPLAB LIB30 object librarians.
- **Emulators** – The latest information on Microchip in-circuit emulators. This includes the MPLAB ICE 2000 and MPLAB ICE 4000.
- **In-Circuit Debuggers** – The latest information on the Microchip in-circuit debugger, MPLAB ICD 2.
- **MPLAB® IDE** – The latest information on Microchip MPLAB IDE, the Windows® Integrated Development Environment for development systems tools. This list is focused on the MPLAB IDE, MPLAB SIM simulator, MPLAB IDE Project Manager and general editing and debugging features.
- **Programmers** – The latest information on Microchip programmers. These include the MPLAB PM3 and PRO MATE® II device programmers and the PICSTART® Plus and PICkit™ 1 development programmers.

CUSTOMER SUPPORT

Users of Microchip products can receive assistance through several channels:

- Distributor or Representative
- Local Sales Office
- Field Application Engineer (FAE)
- Technical Support

Customers should contact their distributor, representative or field application engineer (FAE) for support. Local sales offices are also available to help customers. A listing of sales offices and locations is included in the back of this document.

Technical support is available through the web site at: <http://support.microchip.com>

DOCUMENT REVISION HISTORY

Revision A (March 2007)

- Initial release of this document.

16-Bit 28-Pin Starter Development Board User's Guide

NOTES:



Chapter 1. Introduction

1.1 INTRODUCTION

The 16-Bit 28-Pin Starter Development Board serves as a development kit and evaluation tool for Microchip's 16-bit digital signal controllers and microcontrollers. Topics discussed in this chapter include:

- Development Kit Contents
- Development Board Functionality and Features
- Demonstration Program
- Power Selection
- UART Communication Via USB
- Device Selection
- On-board Peripheral Selection

16-Bit 28-Pin Starter Development Board User's Guide

1.2 DEVELOPMENT KIT CONTENTS

The following items make up the 16-Bit 28-Pin Starter Development Board Development Kit:

- The 16-Bit 28-Pin Starter Development Board printed circuit board (see Figure 1-1)
- Preprogrammed dsPIC33FJ12GP202 device
- The 16-Bit 28-Pin Starter Development Board CD-ROM containing this manual, 16-bit documentation and demonstration program code

FIGURE 1-1: 16-BIT 28-PIN STARTER DEVELOPMENT BOARD

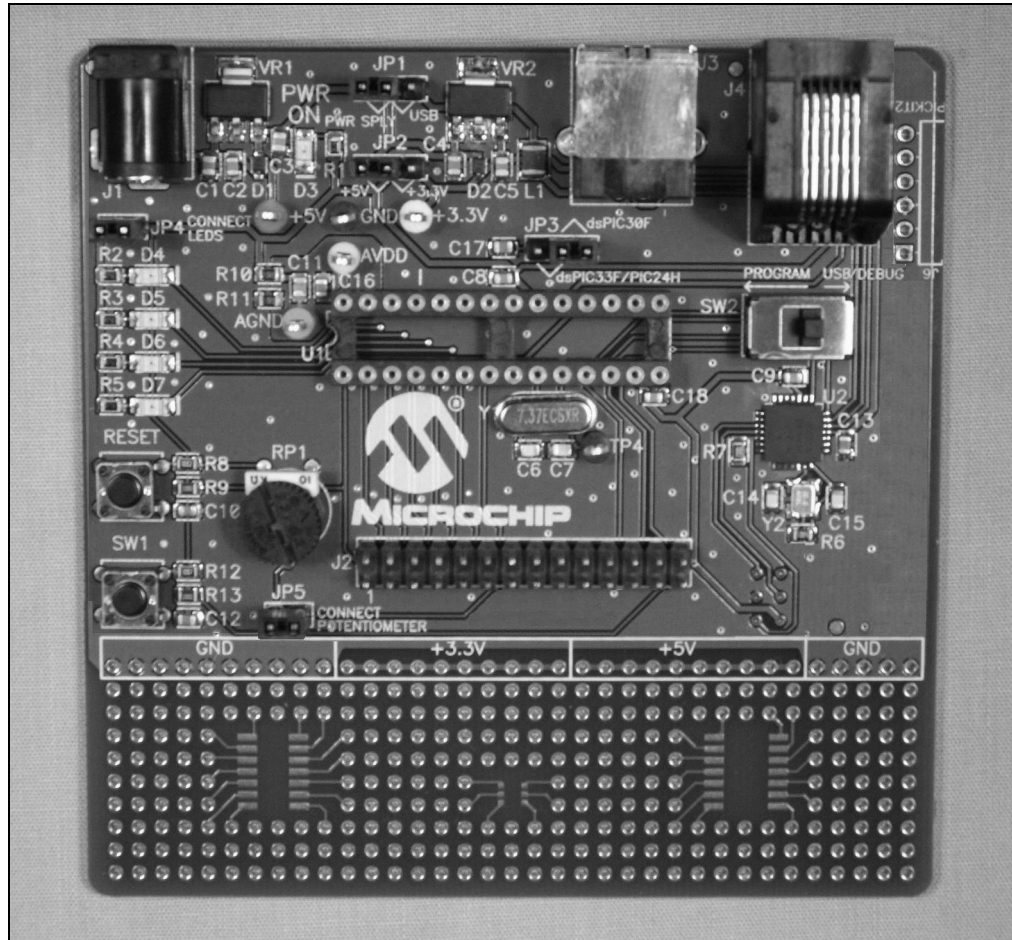

For information on the components used on the 16-Bit 28-Pin Starter Development Board, see **Chapter 4. "Development Hardware"**.

1.3 DEVELOPMENT BOARD FUNCTIONALITY AND FEATURES

The 16-Bit 28-Pin Starter Development Board is an easy-to-use tool that allows you to begin development with dsPIC30F/33F and PIC24 devices. The following capabilities are provided.

Development Board Power

- On-board +5V regulator or +3.3V regulator for VDD and AVDD
- USB power source or 9V DC power source input jack
- Power-on indicator LED

MPLAB ICD 2 Connections

- MPLAB ICD 2 programming connector

UART Communication Channel

- Single UART communication channel via USB bridge

Device Clocking

- 7.37 MHz crystal

Miscellaneous

- Reset push button for resetting the device
- Four LEDs for status indicators
- Push button switch (SW1)
- Potentiometer (RP1) for use with ADC
- All device I/O pins are brought out to a header for test point and prototyping access

1.4 DEMONSTRATION PROGRAM

The 16-Bit 28-Pin Starter Development Board is supplied with a pre-loaded device that demonstrates the following board functionality:

- Interrupt handling using Timer1 to toggle the LEDs
- UART functionality using the on-board USB to echo characters sent from a PC terminal programmed with a 9600 baud rate

Refer to **Chapter 3. “Demonstration Program”** for additional information.

1.5 POWER SELECTION

The 16-Bit 28-Pin Starter Development Board has the option of being powered by a 9V DC power supply or by the USB bus. The position of jumper JP1 determines which power source is used. Connect jumper pins 1 and 2 for the 9V power supply or jumper pins 2 and 3 for the USB.

In addition, jumper JP2 selects either a +5V or +3.3V power source for the targeted device. For dsPIC30F devices, connect jumper pins 1 and 2 for the +5V operation. For dsPIC33F and PIC24 devices, connect jumper pins 2 and 3 for the +3.3V operation.

1.6 UART COMMUNICATION VIA USB

The dsPIC30F/33F and PIC24 devices use an on-board PIC18 and USB interface for UART communications. With switch SW2 in the USB position, the PIC18 is connected to the target device, providing that the UART-to-USB bridge connection has been made. The appropriate USB device driver must be installed prior to UART-to-USB communication. See **Section 2.6.3 “Installing the USB Driver”** for details.

1.7 DEVICE SELECTION

The position of jumper JP3 determines which family of device (dsPIC30F or dsPIC33F/PIC24) to use.

1.8 ON-BOARD PERIPHERAL SELECTION

All on-board peripherals, such as LEDs, potentiometers, and the PIC18 (USB bridge), can be disconnected from the target devices via JP4, JP5 and SW2, respectively.

Chapter 2. Tutorial

2.1 INTRODUCTION

This chapter is a self-paced tutorial to get you started using the 16-Bit 28-Pin Starter Development Board. Topics covered in this chapter include:

- Tutorial Overview
- Equipment Needed
- Creating the Project
- Building the Code
- Programming the Chip
- Running the Application
- Debugging the Code
- Programming the Device for Stand-alone Operation
- Summary

2.2 TUTORIAL OVERVIEW

The tutorial program is located on the CD-ROM provided with the development kit, in the `demo_33F.c` file. The tutorial program is written in C code; therefore, the C30 compiler is required. This program echoes any characters that are sent to the 16-Bit 28-Pin Starter Development Board from the PC via the USB interface. In addition, the program toggles four LEDs. Timer1 is used to create a periodic interrupt, which toggles the LEDs.

The source file is used with a linker script file (`p33fj12gp202.gld`) and a header file (`p33fj12gp202.h`) to form a complete project. This simple project uses a single source code file; however, more complex projects might use multiple assembler and compiler source files as well as library files and precompiled object files.

Note: The CD-ROM provided with the development kit also includes tutorial programs for dsPIC30F, dsPIC33F, and PIC24 devices. This chapter makes reference to the files used for dsPIC33F devices only. If you want to apply the tutorials to dsPIC30F or PIC24 devices, simply substitute the files mentioned in this text with the appropriate device-related file.

There are four steps to this tutorial:

1. Creating a project in MPLAB IDE.
2. Assembling and linking the code.
3. Programming the chip with the MPLAB ICD 2.
4. Debugging the code with the MPLAB ICD 2.

2.3 EQUIPMENT NEEDED

To complete this tutorial, you will need the following items:

1. 16-Bit 28-Pin Starter Development Board
2. 9V, 500 mA Plug-in Power Supply with barrel style plug (optional)
3. MPLAB ICD 2 In-Circuit Debugger
4. USB cable
5. PC running Microsoft Windows® with MPLAB IDE 7.52 or later
6. MPLAB C30 Compiler

2.4 CREATING THE PROJECT

The first step is to create a project and a workspace in MPLAB IDE. Typically, there is one project in one workspace.

A project contains the files needed to build an application (source code, linker script files, etc.) along with their associations to various build tools and build options.

A workspace contains one or more projects and information on the selected device, debug tool and/or programmer, open windows and their location and other MPLAB IDE configuration settings.

MPLAB IDE contains a Project Wizard to help create new projects. Before starting, create a folder for the project files for this tutorial (C:\Tutorial is assumed in the instructions that follow). From the Example Code directory on the 16-Bit 28-Pin Starter Development Board Kit CD, copy the `demo_33F.c` file into the C:\Tutorial folder.

2.4.1 Select a Device

1. Start MPLAB IDE.
2. Close any workspace that might be open (*File>Close Workspace*).
3. From the *Project* menu, select *Project Wizard*.
4. From the Welcome screen, click **Next >** to display the Project Wizard Step One dialog (see Figure 2-1).

FIGURE 2-1: PROJECT WIZARD, STEP 1, SELECT A DEVICE

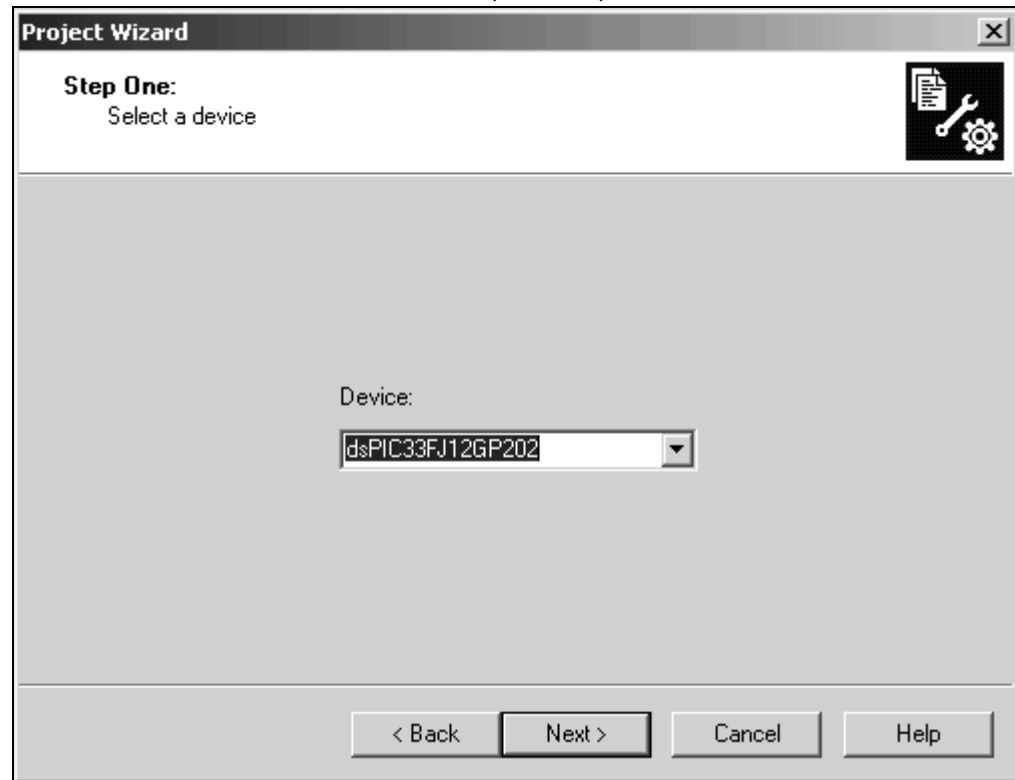

5. From the **Device:** pull-down list, select `dsPIC33FJ12GP202` and click **Next >**. The Project Wizard Step Two dialog appears.

FIGURE 2-2: PROJECT WIZARD, STEP 2, SELECT LANGUAGE TOOLSUITE

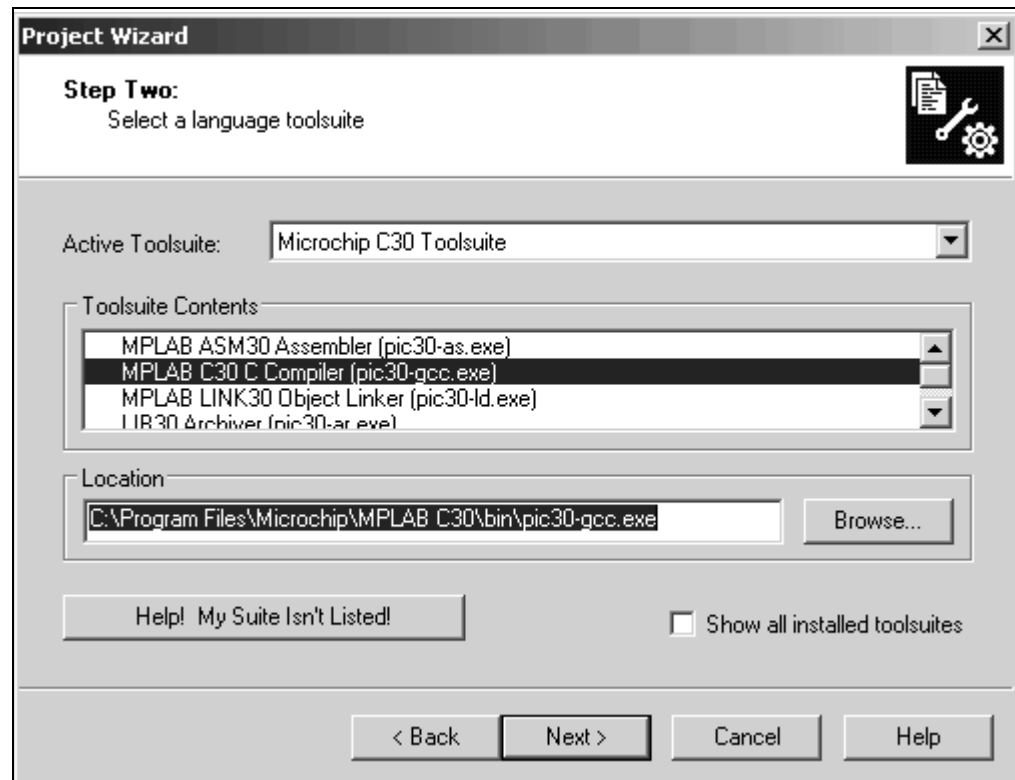

2.4.2 Select Language Toolsuite

1. From the **Active Toolsuite:** pull-down menu, select **Microchip C30 Toolsuite**. This toolsuite includes the compiler and linker that will be used.
2. Click **Next >** to continue. The Project Wizard Step Three dialog appears.

FIGURE 2-3: PROJECT WIZARD, STEP 3, NAME YOUR PROJECT

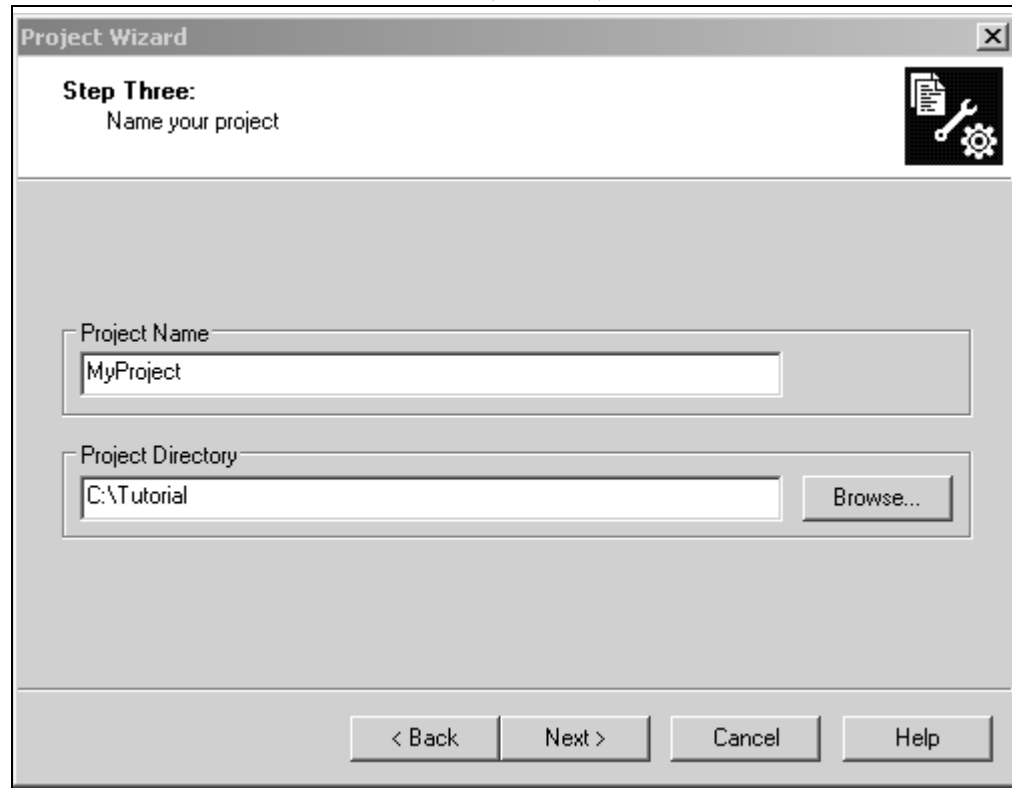

2.4.3 Name Your Project

1. In the **Project Name** text box, type `MyProject`.
2. Click **Browse...** and navigate to `C:\Tutorial\` to place your project in the Tutorial folder.
3. Click **Next >** to continue. The Project Wizard Step Four dialog appears.

FIGURE 2-4: PROJECT WIZARD, STEP 4, ADD FILES TO PROJECT

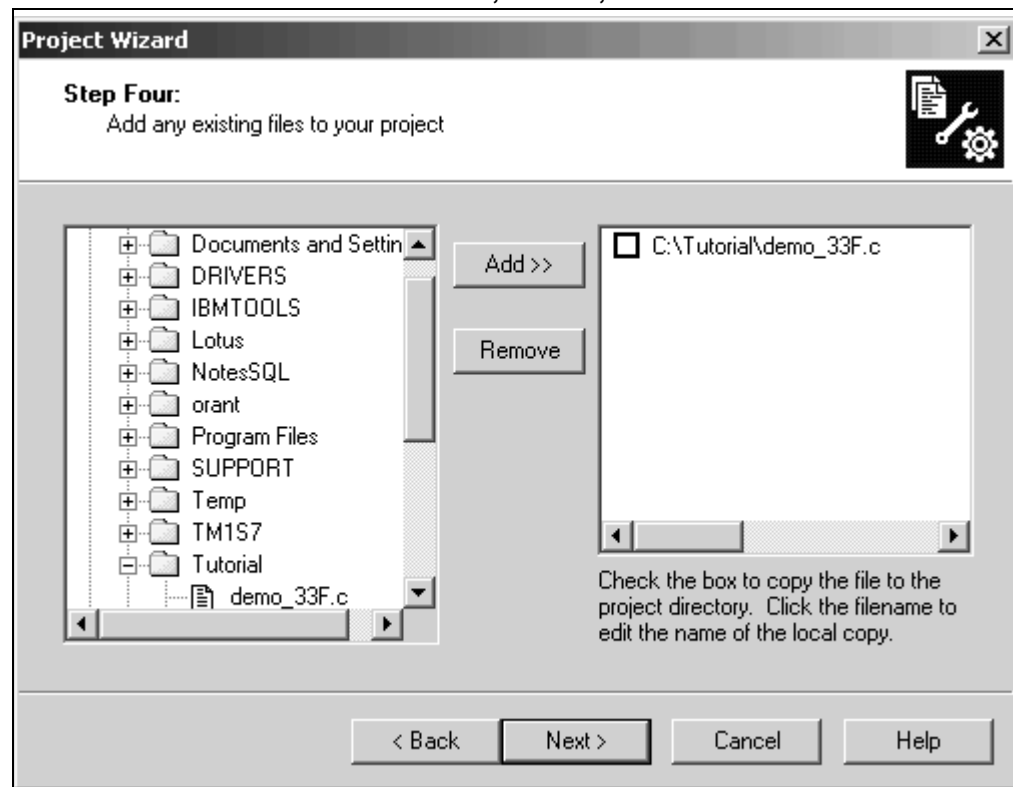

2.4.4 Add Files to the Project

1. Locate the C:\Tutorial folder and select the demo_33F.c file.
2. Click **Add >>** to include the file in the project.
3. Expand the C:\Program Files\Microchip\MPLAB C30\support\gld folder and select the p33fj12gp202.gld file.
4. Click **Add >>** to include this file in the project. There should now be two files in the project.
5. Click **Next >** to continue.
6. When the summary screen appears, click **Finish**.

After the Project Wizard completes, the MPLAB IDE project window shows the demo_33F.c file in the **Source Files** folder, and the p33fj12gp202.gld file in the **Linker Scripts** folder (see Figure 2-5).

FIGURE 2-5: MPLAB® IDE PROJECT WINDOW

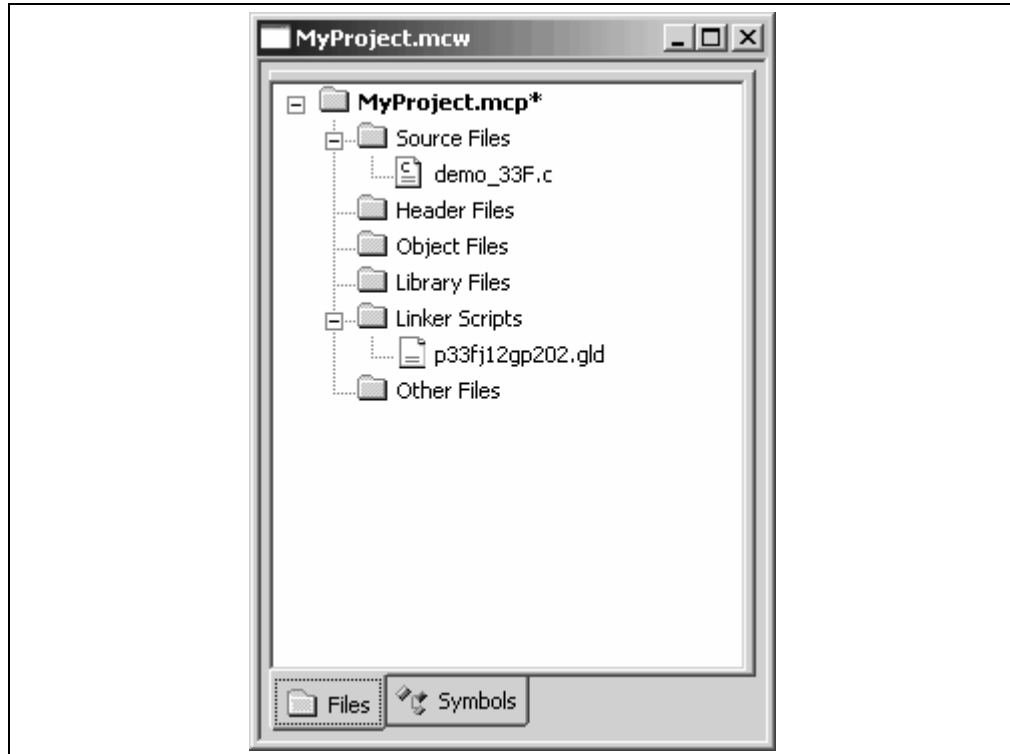

A project and workspace have now been created in MPLAB IDE. `MyProject.mcw` is the workspace file and `MyProject.mcp` is the project file. Double click the `demo_33F.c` file in the project window to open the file.

2.5 BUILDING THE CODE

1. From the *Project* menu select **Build All**. The Build Output window appears.

FIGURE 2-6: BUILD OUTPUT WINDOW

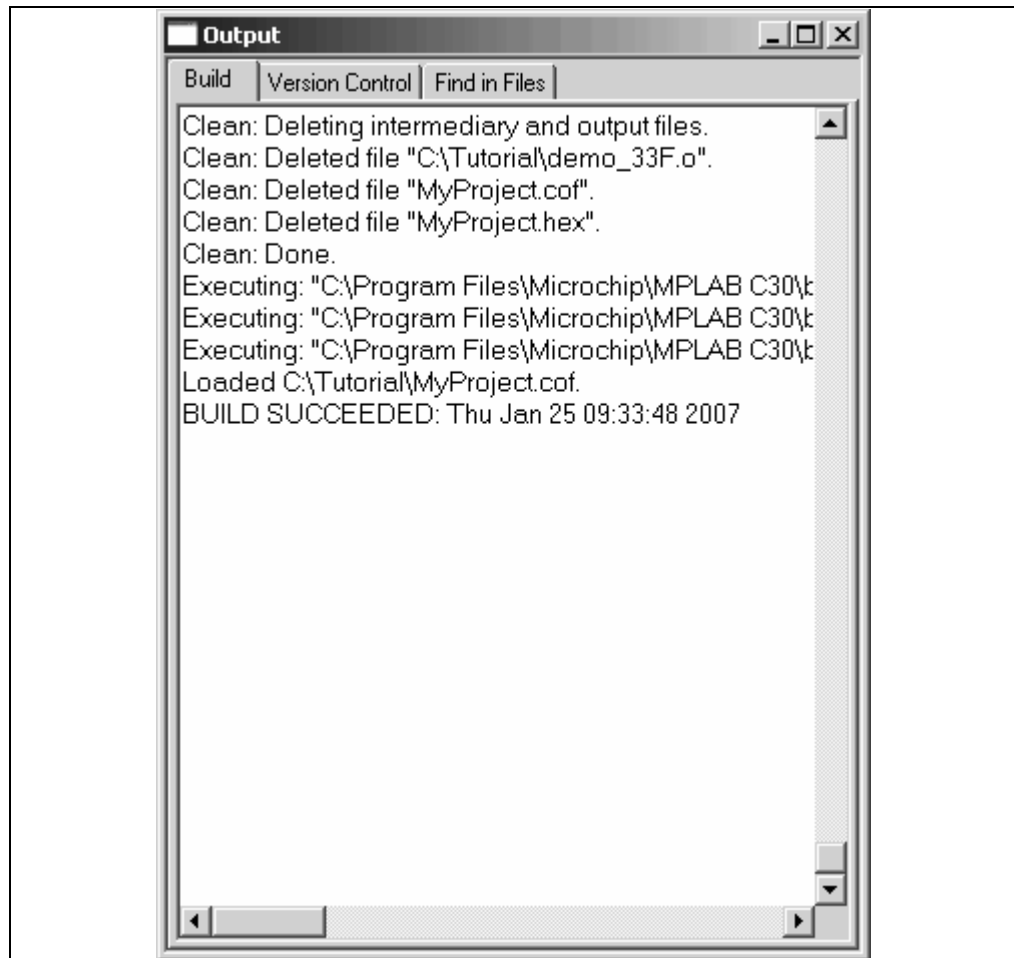

2. Observe the progress of the build.
3. When the BUILD SUCCEEDED message appears, you are ready to program the device.

16-Bit 28-Pin Starter Development Board User's Guide

2.6 PROGRAMMING THE CHIP

The MPLAB ICD 2 In-Circuit Debugger can be used to program and debug the device on the 16-Bit 28-Pin Starter Development Board. For this demonstration, we will use the **Debug** option, which will need to be selected. From the MPLAB IDE main screen, select the pull-down menu and change **Release** to **Debug**.

Note: Before proceeding, make sure that the USB driver for the MPLAB ICD 2 has been installed on the PC (see the "MPLAB ICD 2 User's Guide", (DS51331) for more details regarding the installation of the MPLAB ICD 2).

Use the following MPLAB IDE procedures to program the dsPIC30F/33F and PIC24 devices.

2.6.1 Set Up The Device Configuration

Use the *Configure>Configuration Bits* menu to display the configuration settings. The Configuration Bits window is shown in Figure 2-7.

The device Configuration bits determine global device operating parameters, such as clock source, brown out threshold voltage and so on. For this code example, the following configuration settings will be defined:

- The oscillator source will be set to internal FRC with PLL
- The primary oscillator will be disabled
- The watchdog timer will be disabled

Using these configuration settings will ensure that the device runs at maximum speed.

FIGURE 2-7: CONFIGURATION SETTINGS

Address	Value	Category	Setting
F80000	000F	Boot Segment Write Protect	Boot Segment may be written
		Boot Segment Program Flash Code Protection	No Boot Segment
F80004	0007	General Code Segment Write Protect	General Segment may be written
		General Segment Code Protection	Disabled
F80006	0081	Oscillator Mode	Internal Fast RC (FRC) w/ PLL
		Two-speed Oscillator Start-Up Enable	Start up with FRC, then switch
F80008	00E7	Clock Switching and Monitor	Sw Disabled, Mon Disabled
		Peripheral Pin Select Configuration	Allow Only One Re-configuration
		OSCI/OSCO Pin Function	OSCO pin has clock out function
		Primary Oscillator Source	Primary Oscillator Disabled
F8000A	005F	Watchdog Timer Postscaler	1:32,768
		WDT Prescaler	1:128
		Watchdog Timer Window	Non-Window mode
		Watchdog Timer Enable	Disable
F8000C	00E7	POR Timer Value	128ms
		Alternate I2C pins	I2C mapped to ASDA1/ASCL1
F8000E	00C3	Comm Channel Select	Use PG1/EMUC1 and PGD1/EMUD1
		JTAG Port Enable	Disabled
		Set Clip On Emulation Mode	Reset Into Operational Mode

2.6.2 Select the MPLAB ICD 2 Communication Pins

All dsPIC30F/33F and PIC24 devices use a pair of I/O pins (PGCx/EMUCx and PGDx/EMUDx) for initially loading your application program into the device, and for communicating with the MPLAB ICD 2 In-Circuit Debugger. Typically, these pins can be used by your application program for other functions after your program is loaded into the device. However, these application functions are not available while you are connected to the MPLAB ICD 2 for debugging.

To circumvent this issue, most dsPIC30F/33F and PIC24 devices use one or more sets of alternate pins for MPLAB ICD 2 communication. These alternate pins are identified as EMUCx and EMUDx, where x designates the number of the pin pair. By selecting an alternate set of pins for the MPLAB ICD 2, you can safely use the original I/O pins for your application.

For this development board, the pin pairs, PGCx/EMUCx, on device pins 4, 5, 11 and 12 are used for debugging.

Note: SW2 must be switched to the “Program” position for dsPIC30F devices when the application is being programmed into a device with MPLAB ICD 2. Once programming is complete, SW2 must be switched back to the “USB/Debug” position for UART communication via the USB bridge. See Figure 4-1 for the location of this switch.

To select the MPLAB ICD 2 communication pins:

1. On the Configuration Bits screen (Figure 2-7), go to the **Comm Channel Select** category.
2. In the **Setting** column, set this parameter to **Use PGC1/EMUC1 and PGD1/EMUD1**.

2.6.3 Installing the USB Driver

1. Apply power to the board. Refer to **Section 1.5 “Power Selection”** for details.
2. Select the dsPIC33F device configuration. Refer to **Section 1.7 “Device Selection”** for details.
3. Connect the 16-Bit 28-Pin Starter Development Board to the PC with the USB cable. The Found New Hardware Wizard dialog appears as shown in Figure 2-8.

FIGURE 2-8: FOUND NEW HARDWARE WIZARD



4. Select **No, not this time**, then click **Next >** to continue. The Found New Hardware Wizard, Select Installation Location dialog appears.
5. Select **install from a list or specific location**, then click **Next >** to continue. The Found New Hardware Wizard, Search and Installation Options dialog appears as shown in Figure 2-9.

FIGURE 2-9: FOUND NEW HARDWARE WIZARD, SEARCH AND INSTALLATION OPTIONS

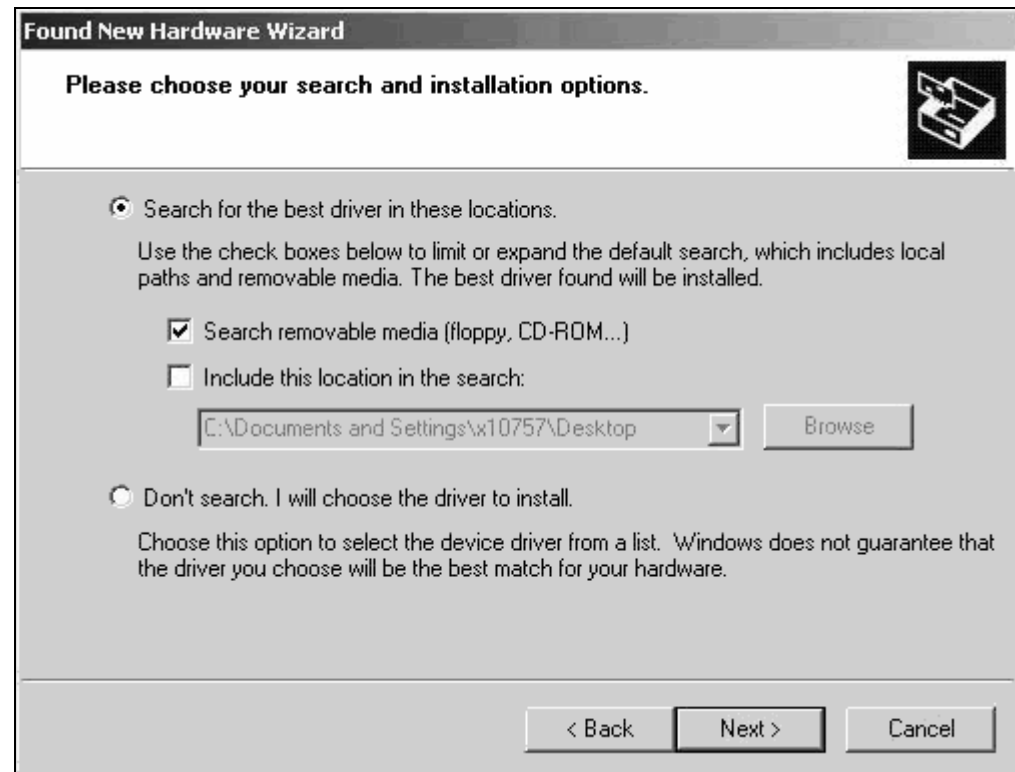

Note: Before continuing to the next step, make sure that the 16-Bit 28-Pin Starter Development Board CD-ROM is inserted in the CD-ROM drive.

6. Select the **Search for the best driver in these locations** radio button and select the **Search removable media (floppy, CD-ROM...)** check box, then click **Next >** to continue.
7. Windows installs the USB driver. Select **Finish** to close the Found New Hardware Wizard.

2.6.4 Connect the MPLAB ICD 2 In-Circuit Debugger

1. Connect the MPLAB ICD 2 to the PC with the USB cable.
2. Connect the MPLAB ICD 2 to J4 on the 16-Bit 28-Pin Starter Development Board with the short RJ-11 (telephone) cable.
3. For dsPIC30F devices only, verify that SW2 is in the “Program” position.

2.6.5 Enable MPLAB ICD 2 Connection

1. From the *Debugger* menu, click *Select Tool>MPLAB ICD 2* to designate the MPLAB ICD 2 as the debug tool in MPLAB IDE.
2. From the *Debugger* menu, select *Connect* to connect the debugger to the device. The MPLAB IDE should report that it found the device, as shown in Figure 2-10.

Note: MPLAB IDE may need to download new firmware if this is the first time the MPLAB ICD 2 is being used with a dsPIC30F device. Allow it to do so. If any errors are shown, double click the error message to get more information.

FIGURE 2-10: ENABLING MPLAB® ICD 2

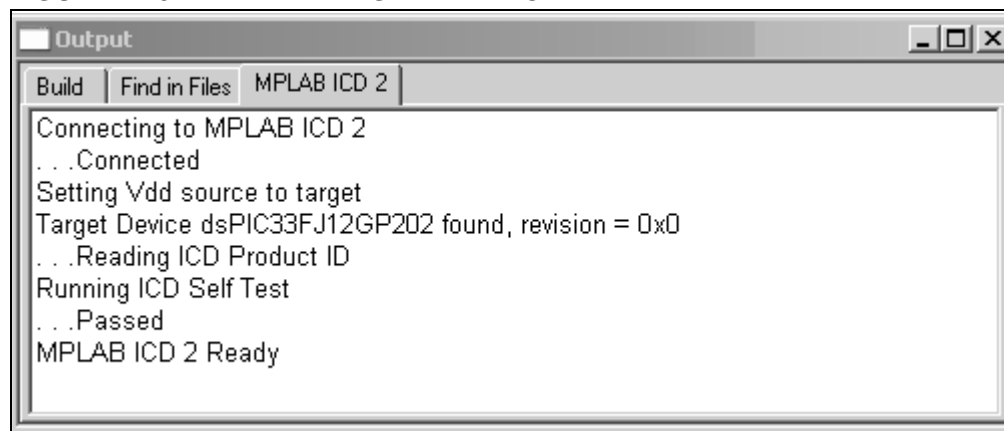

2.6.6 Program the Device

Note: SW2 must be switched to the “Program” position for dsPIC30F devices when the application is being programmed into a device with MPLAB ICD 2. Once programming is complete, SW2 must be switched back to the “USB/Debug” position for UART communication via the USB bridge. See Figure 4-1 for the location of this switch.

From the *Debugger* menu, select *Program* to program the part. The output window (Figure 2-11) displays the program steps as they occur.

FIGURE 2-11: PROGRAMMING THE DEVICE

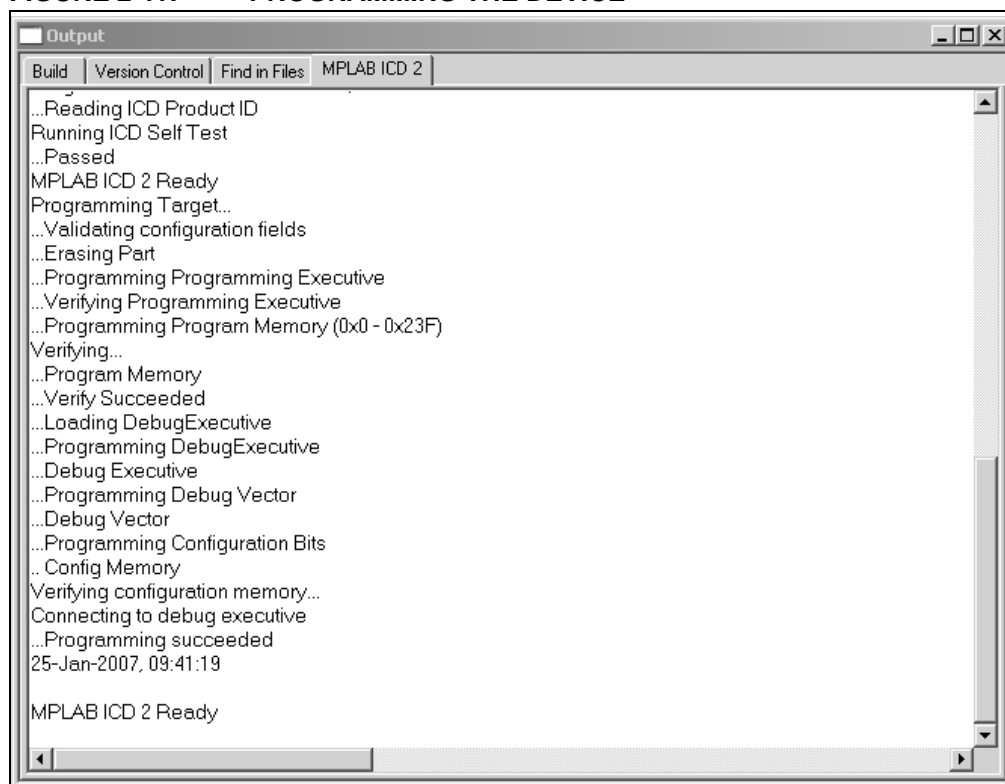

2.7 RUNNING THE APPLICATION

2.7.1 Configure the UART-to-USB Connection

1. On the PC, right click **My Computer** and select **Properties**.
2. Select the **Hardware** tab and click **Device Manager**.
3. In the **Ports** group, verify that an additional COM port is mapped. This COM port is from the PCB to the PC and will be used in the HyperTerminal demonstration.
4. Open the Windows® HyperTerminal program from the CD-ROM and select the **File>Properties** menu and verify that the correct COM port is selected for the USB cable from the PCB.

The COM settings for this port are: 9600 bits per second, no parity, 8 data bits and 1 stop bit. When a character is entered on the keyboard, it should be echoed enclosed in quotes (i.e., input a, output "a") on the HyperTerminal display when the demonstration program is running.

2.7.2 Executing the Application

Note: SW2 must be switched to the "Program" position for dsPIC30F devices when the application is being programmed into a device with MPLAB ICD 2. Once programming is complete, SW2 must be switched back to the "USB/Debug" position for UART communication via the USB bridge. See Figure 4-1 for the location of this switch.

Select **Debugger>Run** to execute the code. All four LEDs on the development board should start blinking twice per second. (If using a dsPIC30F device, switch SW2 to USB after executing the code.)

2.8 DEBUGGING THE CODE

The MPLAB ICD 2 In-Circuit Debugger can be used to run, halt and step the code. A breakpoint can be set to halt the program once the code has executed the instruction at the breakpoint. The contents of the RAM and registers can be viewed whenever the processor has been halted.

The MPLAB ICD 2 In-Circuit Debugger uses the following function keys to access the main debugging functions:

- <F5> Halt
- <F6> Reset
- <F7> Single Step
- <F9> Run

In addition, there are more functions available by right clicking on a line of source code. The most important of these are **Set Breakpoint** and **Run to Cursor**.

2.8.1 Display the Code

1. From the View menu, select Program Memory.
2. In the Program Memory window, select the **S**ymbolic tab, as shown in Figure 2-12.

FIGURE 2-12: PROGRAM MEMORY WINDOW

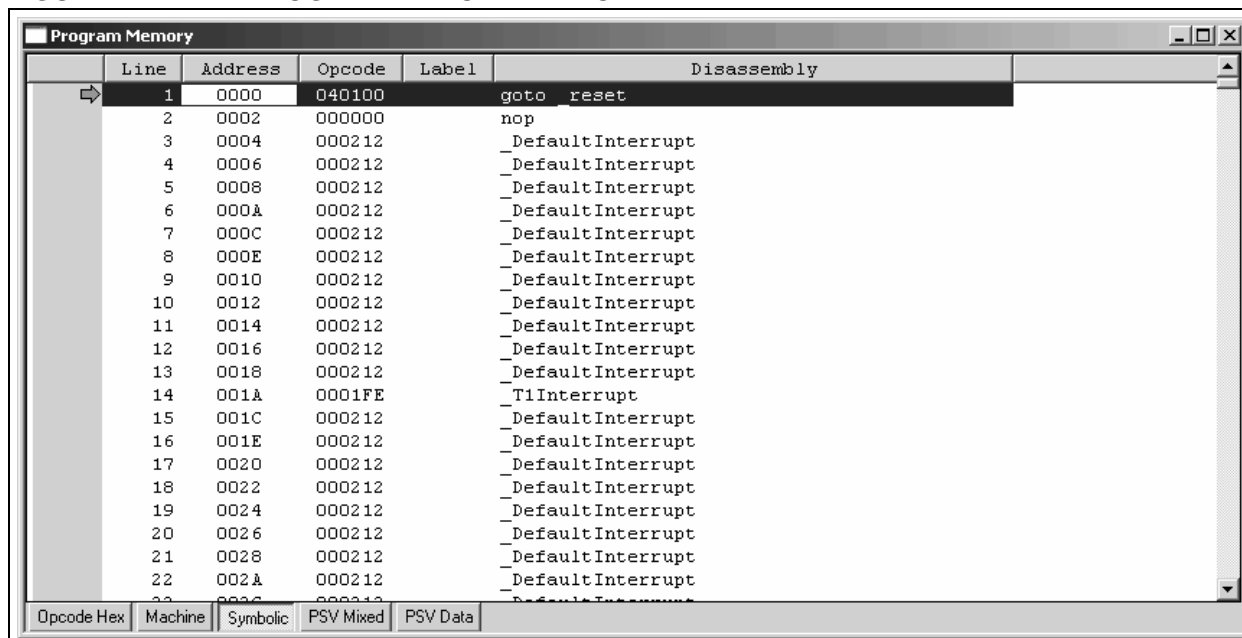

3. Press <F5> to halt the processor and press <F6> to reset the processor. The program memory now shows a green arrow pointing to the line of code at address 00000, which is the reset location.

The instruction at this location is `goto _reset`. This code is added by the linker to make the program branch to the start of the code in the `demo_33F.c` file.

2.8.2 Step the Program

1. After halting the program, press <F7> to single step the code. Notice the location of the green arrow when single stepping. In this demonstration, the code will halt in the `while` loop of the UART, as shown in Figure 2-13.

FIGURE 2-13: SOURCE CODE WINDOW

```

C:\Tutorial\demo_33F.c
_U1RXIF=0;

while(1)
{
    while (_UIRXIF==0);

    int a;
    while(!UISTAbits.TRMT);
    U1TXREG = ' ';
    while(!UISTAbits.TRMT);
    a = U1RXREG;
    U1TXREG = a;
    while(!UISTAbits.TRMT);
    U1TXREG = ' ';
    while(!UISTAbits.TRMT);
    U1TXREG = ' ';

    _UIRXIF=0;
}
return 0;
}
void __attribute__((__interrupt__)) _T1Interrupt(void)
{
    IFS0bits.T1IF = 0; // clear interrupt flag

    LATE ^= 0xF;
}

```

2. Right click the line of code, `LATE ^= 0xF;`, and choose *Run to Cursor*. The green arrow moves to the bracket below the line of code because it has executed the prior lines of code up to and including `LATE ^= 0xF;`.
3. From the *View* menu, select *Watch* to open a Watch window.
4. From the **Add SFR** pull-down list, display **PC**.
5. Click **Add SFR** to add the PC register to the Watch window.
6. Press <F7> a few times and watch the PC value increment (see Figure 2-14). PC is the repeat loop counter that increments with each step.

FIGURE 2-14: WATCH WINDOW DISPLAY

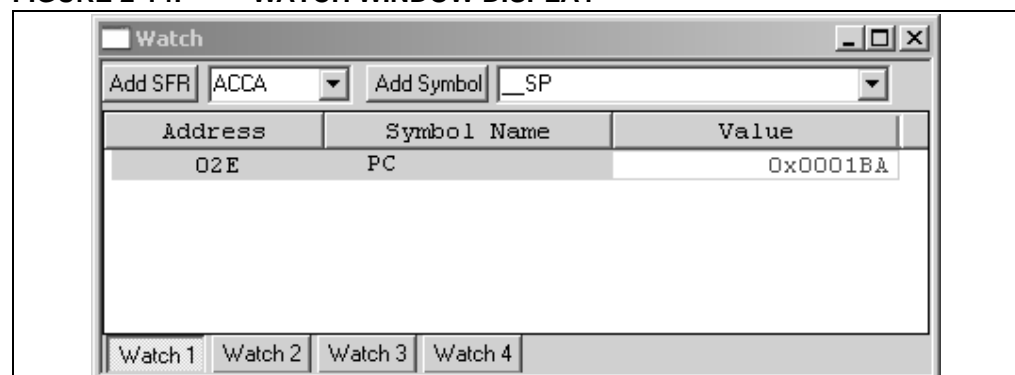

2.8.3 Set Breakpoint

1. To set a breakpoint, right click a code line and select *Set Breakpoint* from the pop-up menu.

Note: An alternate method is to simply double click the line. This feature may need to be enabled using the *Edit>Properties* menu.

As an example, find the following line of code and set a breakpoint on this line:

```
IFS0bits.T1IF = 0;
```

A red stop sign should appear in the gutter (gray bar on the left) of the source code window.

2. Press <F6> to reset the device, then <F9> to execute the code. The program halts on the instruction following the breakpoint as shown in Figure 2-15. When MPLAB ICD 2 is halted, the next instruction is executed. Observe that the LEDs on the development board remain lit.

Note: The instruction on which the code halts could be elsewhere in the code if the breakpoint is set on a branch or call instruction. Refer to **Section 12. "Important Notes"** in the readme file MPLAB ICD 2.txt located in the C:\MPLAB IDE\READMEs directory for additional operational information on the MPLAB ICD 2.

FIGURE 2-15: SETTING BREAKPOINT

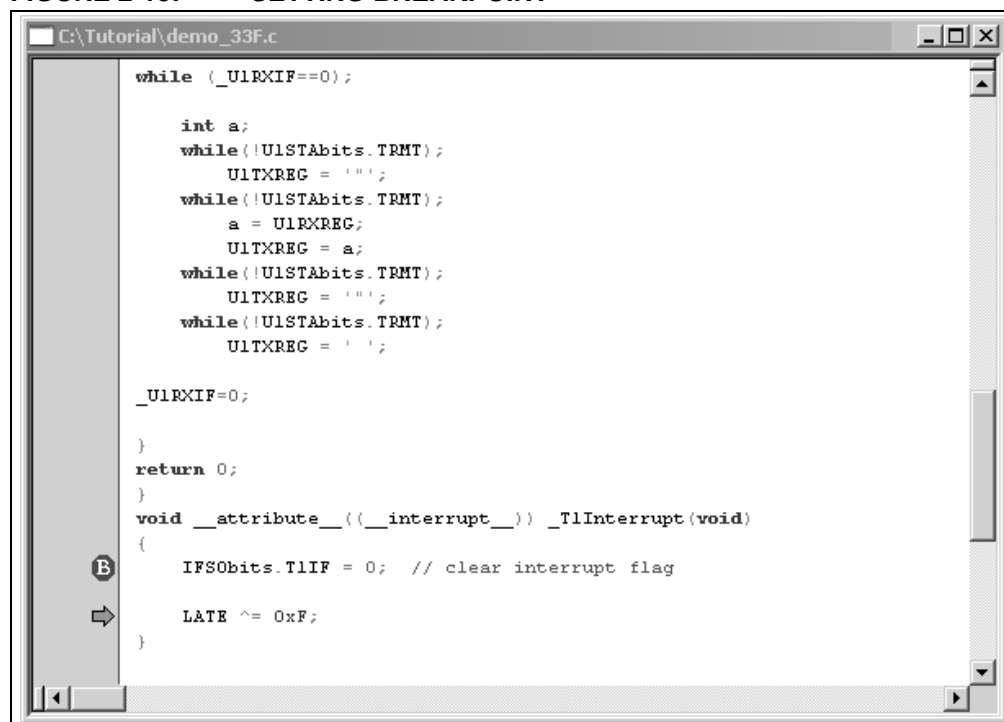

2.9 PROGRAMMING THE DEVICE FOR STAND-ALONE OPERATION

The previous example showed you the basics of code debugging using the MPLAB ICD 2. When you have fully debugged your application, you will want to run the code without using the MPLAB ICD 2. In the following example, the MPLAB ICD 2 is enabled as a device programmer instead of a debugger.

1. Starting with the project you have created in this tutorial, select MPLAB ICD 2 as the device programmer. From the *Programmer* menu, select the *Select Programmer>MPLAB ICD 2* option.

If you were previously using the MPLAB ICD 2 as a debugger tool, you will receive a warning message indicating that the tool cannot be enabled as a programmer and a debugger at the same time. Click **OK** in the warning message to continue.

Note: SW2 must be switched to the “Program” position for dsPIC30F devices when the application is being programmed into a device with MPLAB ICD 2. Once programming is complete, SW2 must be switched back to the “USB/Debug” position for UART communication via the USB bridge. See Figure 4-1 for the location of this switch.

2. From the *Program* menu, select *Program* to program the part. The output window will look similar to Figure 2-11, except that the debugging features of the device will not be enabled.
3. Remove the MPLAB ICD 2 programming cable connected to J4. When the cable is unplugged, the device will begin to run the application.

2.10 SUMMARY

This tutorial demonstrates the main features of the MPLAB IDE and MPLAB ICD 2 as they are used with the 16-Bit 28-Pin Starter Development Board. Upon completing this tutorial, you should be able to:

- Create a project using the Project Wizard
- Set the Configuration bits
- Set up MPLAB IDE to use the MPLAB ICD 2 In-Circuit Debugger
- Program the chip with the MPLAB ICD 2
- View the code execution in program memory and source code
- View registers in a Watch window
- Set a breakpoint and make the code halt at a chosen location
- Use the function keys to reset, run, halt and single step the code
- Program the device for Debugger mode or stand-alone operation

16-Bit 28-Pin Starter Development Board User's Guide

NOTES:

Chapter 3. Demonstration Program

3.1 INTRODUCTION

This chapter provides an overview of the 16-Bit 28-Pin Starter Development Board demonstration program. Detailed information on the 16-Bit 28-Pin Starter Development Board hardware is presented in **Chapter 4. “Development Hardware”** and **Appendix A. “Drawings and Schematics”**.

Topics discussed in this chapter include:

- Demonstration Program Summary
- Demonstration Program Description
- Demonstration Program Setup

3.2 DEMONSTRATION PROGRAM SUMMARY

The 16-Bit 28-Pin Starter Development Board is shipped with a simple example application programmed into the dsPIC33FJ12GP202 device. This program demonstrates the use of key functionality.

3.3 DEMONSTRATION PROGRAM DESCRIPTION

When power is applied to the 16-Bit 28-Pin Starter Development Board the device begins executing the demonstration program. The program demonstrates the following functions:

- UART communication
- Timer interrupt

3.3.1 UART Communication

The demonstration program uses the UART peripheral to communicate with the PC HyperTerminal application via the on-board UART-to-USB bridge. The demonstration program waits for the character to be received from the PC, and echoes it back to the PC enclosed in quotes.

3.3.2 Timer Interrupt

To illustrate interrupt processing, the demonstration program uses Timer1 to generate interrupts, which cause the LEDs to blink. The clock prescaler and period register for Timer1 are configured to produce an interrupt every 250 ms.

3.4 DEMONSTRATION PROGRAM SETUP

3.4.1 Installing the USB Driver

1. Apply power to the board. Refer to 1.5 “Power Selection” for details.
2. Select the dsPIC33F device configuration. Refer to 1.7 “Device Selection” for details.
3. Connect the 16-Bit 28-Pin Starter Development Board to the PC with the USB cable. The Found New Hardware Wizard dialog appears as shown in Figure 3-1.

FIGURE 3-1: FOUND NEW HARDWARE WIZARD



4. Select **No, not this time**, then click **Next >** to continue. The next Found New Hardware Wizard, Select Installation Location dialog appears.
5. Select **install from a list or specific location**, then click **Next >** to continue. The Found New Hardware Wizard, Search and Installation Options dialog appears as shown in Figure 3-2.

FIGURE 3-2: FOUND NEW HARDWARE WIZARD, SEARCH AND INSTALLATION OPTIONS

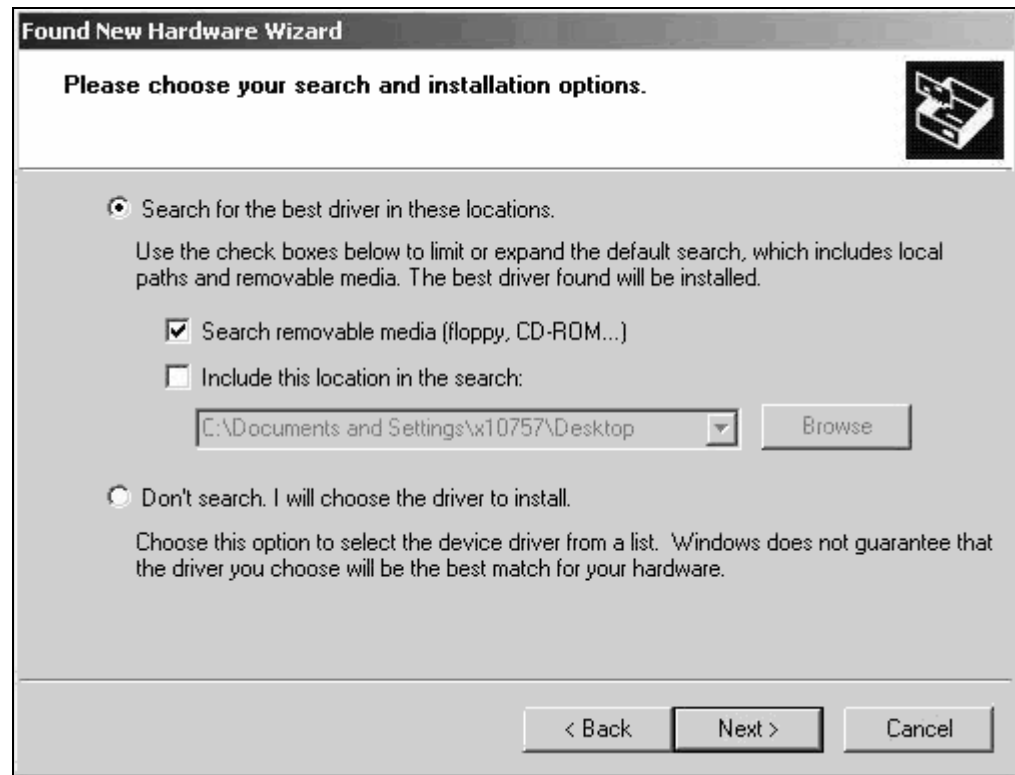

Note: Before continuing to the next step, make sure that the 16-Bit 28-Pin Starter Development Board CD-ROM is inserted in the CD-ROM drive.

6. Select the **Search for the best driver in these locations** radio button and select the **Search removable media (floppy, CD-ROM...)** check box, then click **Next >** to continue.
7. Windows installs the USB driver. Select **Finish** to close the Found New Hardware Wizard.

3.4.2 Configure the UART-to-USB Connection

1. On the PC, right click **My Computer** and select **Properties**.
2. Select the **Hardware** tab and click **Device Manager**.
3. In the **Ports** group, verify that an additional COM port is mapped. This COM port is from the PCB to the PC and will be used in the HyperTerminal demonstration.
4. Open the Windows® HyperTerminal program from the CD-ROM and select the **File>Properties** menu and verify that the correct COM port is selected for the USB cable from the PCB.

The COM settings for this port are: 9600 bits per second, no parity, 8 data bits, and 1 stop bit. When a character is entered on the keyboard, it should be echoed enclosed in quotes (i.e., input a, output "a") on the HyperTerminal display when the demonstration program is running.

16-Bit 28-Pin Starter Development Board User's Guide

NOTES:

Chapter 4. Development Hardware

4.1 INTRODUCTION

This chapter describes the 16-Bit 28-Pin Starter Development Board hardware, and includes the following topics:

- Hardware Overview
- Hardware Elements

4.2 HARDWARE OVERVIEW

FIGURE 4-1: 16-BIT 28-PIN STARTER DEVELOPMENT BOARD

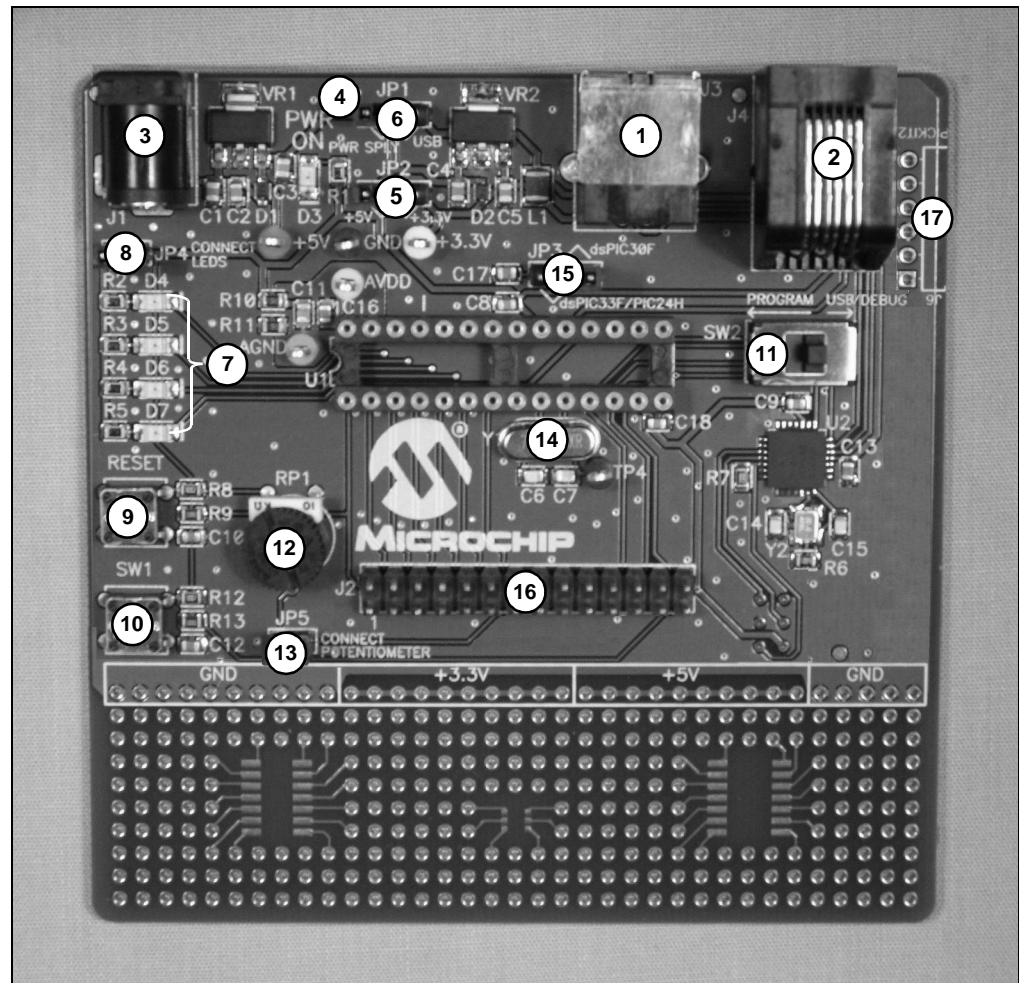

16-Bit 28-Pin Starter Development Board User's Guide

TABLE 4-1: 16-BIT 28-PIN STARTER DEVELOPMENT BOARD HARDWARE ELEMENTS

No.	Name	Description
1	J3	USB Port
2	J4	MPLAB [®] ICD 2 Connector
3	J1	Power Supply Connector
4	D3	Power On Indicator
5	JP2	+5V or +3.3V Jumper
6	JP1	Power Supply or USB Jumper
7	D4-D7	LED Indicators
8	JP4	LED Connect Jumper
9	RESET	Reset Button
10	SW1	Switch 1
11	SW2	Switch 2
12	RP1	Potentiometer
13	JP5	Potentiometer Connect Jumper
14	Y1	Oscillator
15	JP3	Device Selection Jumper
16	J2	I/O Header
17	J6	PICkit™ 2 Connector

4.3 HARDWARE ELEMENTS

4.3.1 USB Port (J3)

The 16-Bit 28-Pin Starter Development Board provides one USB communication channel. The USB communication channel is labeled J3. The device communicates using the UART to the on-board PIC18 through the U1RX and U1TX pins, which then communicates through the USB port. The USB port can also be used to power the development board.

4.3.2 MPLAB ICD 2 Connector (J4)

By way of this modular connector, the MPLAB ICD 2 can be connected for low-cost programming and debugging of the device.

4.3.3 Power Supply Connector (J1)

The 16-Bit 28-Pin Starter Development Board can be powered by a 9V AC/DC wall adapter with a standard 2.1 mm barrel plug.

4.3.4 Power On Indicator (D3)

A green LED is connected to the output of the regulators to indicate the presence of power.

4.3.5 +5V or +3.3V Jumper (JP2)

This jumper is used at +5V when a dsPIC30F family device is being used, and at +3.3V when a dsPIC33F or PIC24 family device is being used.

4.3.6 Power Supply or USB Jumper (JP1)

This jumper allows the circuit to be powered by a 9V power supply (J1) or by the USB port (J3).

4.3.7 LED Indicators (D4-D7)

LEDs are connected to the device for user operations.

4.3.8 LED Connect Jumper (JP4)

If removed, this jumper restricts the use of the LEDs.

4.3.9 Reset Button (RESET)

The $\overline{\text{MCLR}}$ Reset button is connected to the processor $\overline{\text{MCLR}}$ pin, which provides a hard Reset to the device.

4.3.10 Switch 1 (SW1)

This switch is connected to the devices for user operations.

4.3.11 Switch 2 (SW2)

This switch, when used with a dsPIC30F family device, programs the device to communicate with the PC by USB. If using a dsPIC33F or PIC24 family device, this switch should be in the USB position at all times.

4.3.12 Potentiometer (RP1)

This potentiometer is connected to the devices for the use of the ADC peripheral.

4.3.13 Potentiometer Connect Jumper (JP5)

This jumper allows the use of the potentiometer.

4.3.14 Oscillator (Y1)

A crystal oscillator (7.37 MHz) is supplied. The crystal oscillator can be used with the on-chip PLL circuit to provide internal instruction execution frequencies.

4.3.15 Device Selection Jumper (JP3)

This jumper determines whether the dsPIC30F or dsPIC33F/PIC24 device is used.

4.3.16 I/O Header (J2)

All device I/O pins are brought out to this header for test points and prototyping access.

4.3.17 PICKit™ 2 Connector (J6)

By way of this modular connector, the PICKit 2 can be connected for low cost programming and debugging of the device.

16-Bit 28-Pin Starter Development Board User's Guide

NOTES:

Appendix A. Drawings and Schematics

A.1 INTRODUCTION

This appendix contains the schematics and layouts for the 16-Bit 28-Pin Starter Development Board. Diagrams included in this appendix:

- 16-bit 28-Pin Starter Development Board Layout
- 16-bit 28-Pin Starter Development Board Schematics

A.2 16-BIT 28-PIN STARTER DEVELOPMENT BOARD LAYOUT

FIGURE A-1: 16-BIT 28-PIN STARTER DEVELOPMENT BOARD LAYOUT

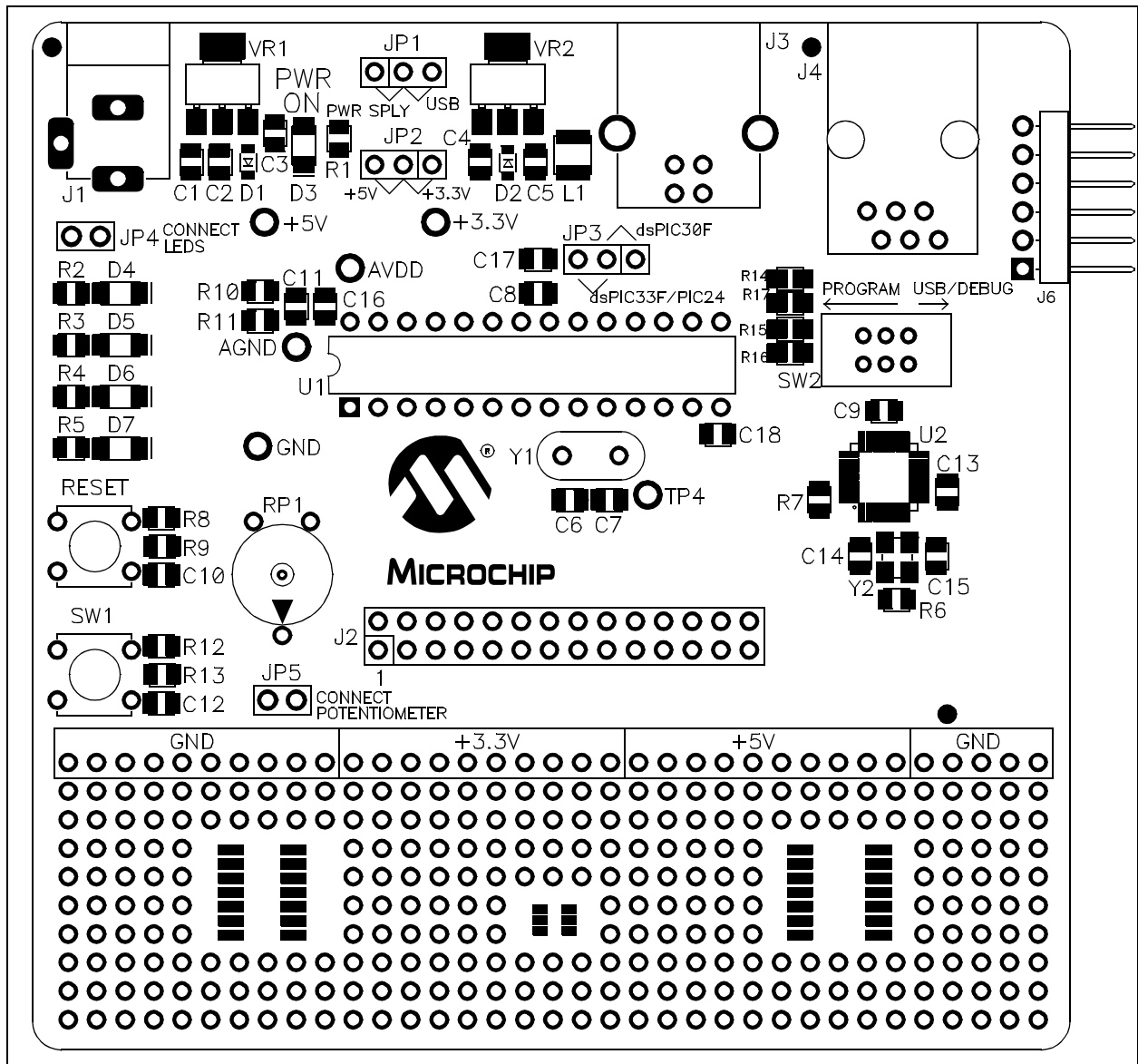

16-Bit 28-Pin Starter Development Board User's Guide

A.3 16-BIT 28-PIN STARTER DEVELOPMENT BOARD SCHEMATICS

FIGURE A-2: 16-BIT 28-PIN STARTER DEVELOPMENT BOARD SCHEMATIC (SHEET 1 OF 2)

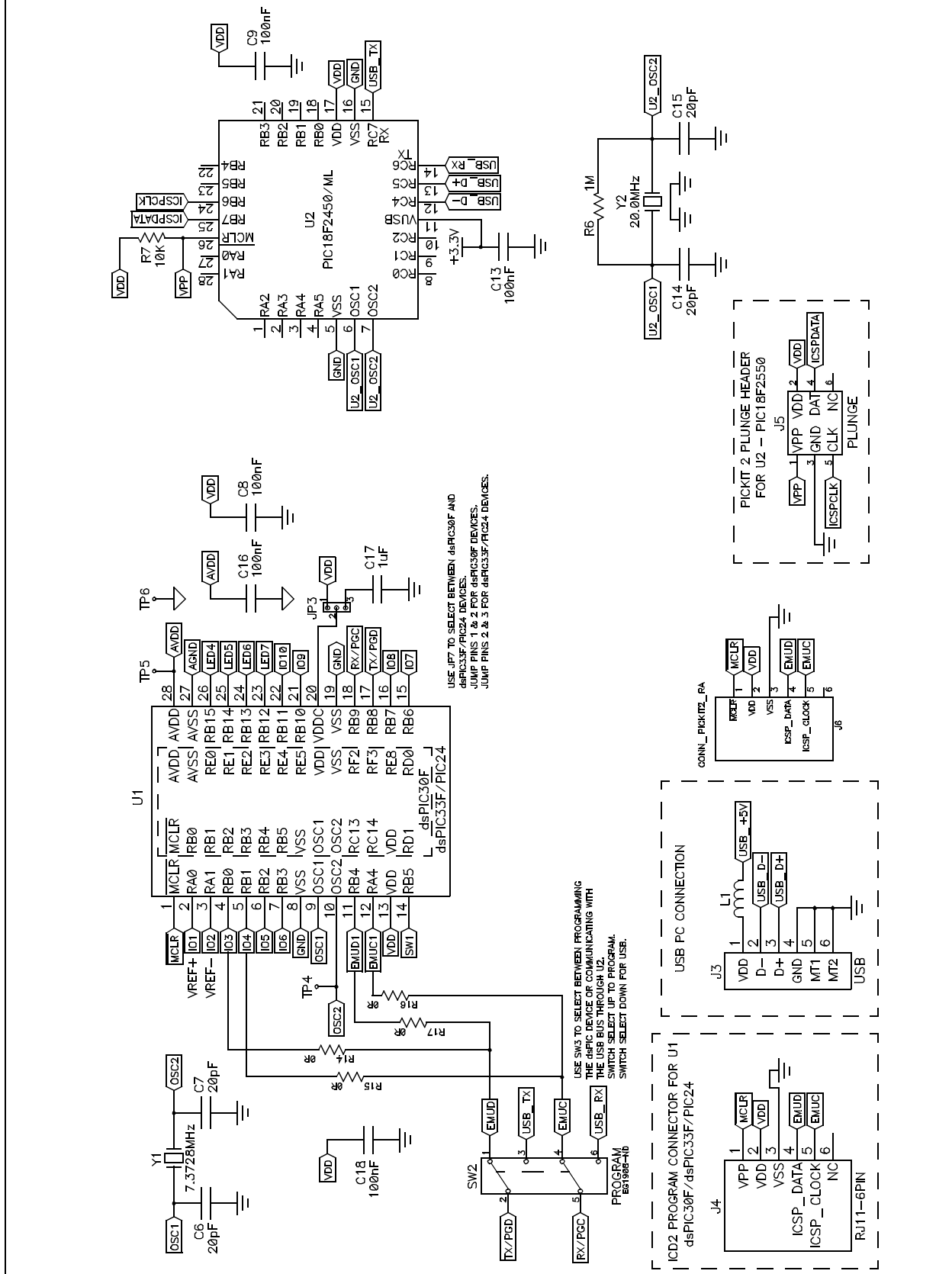
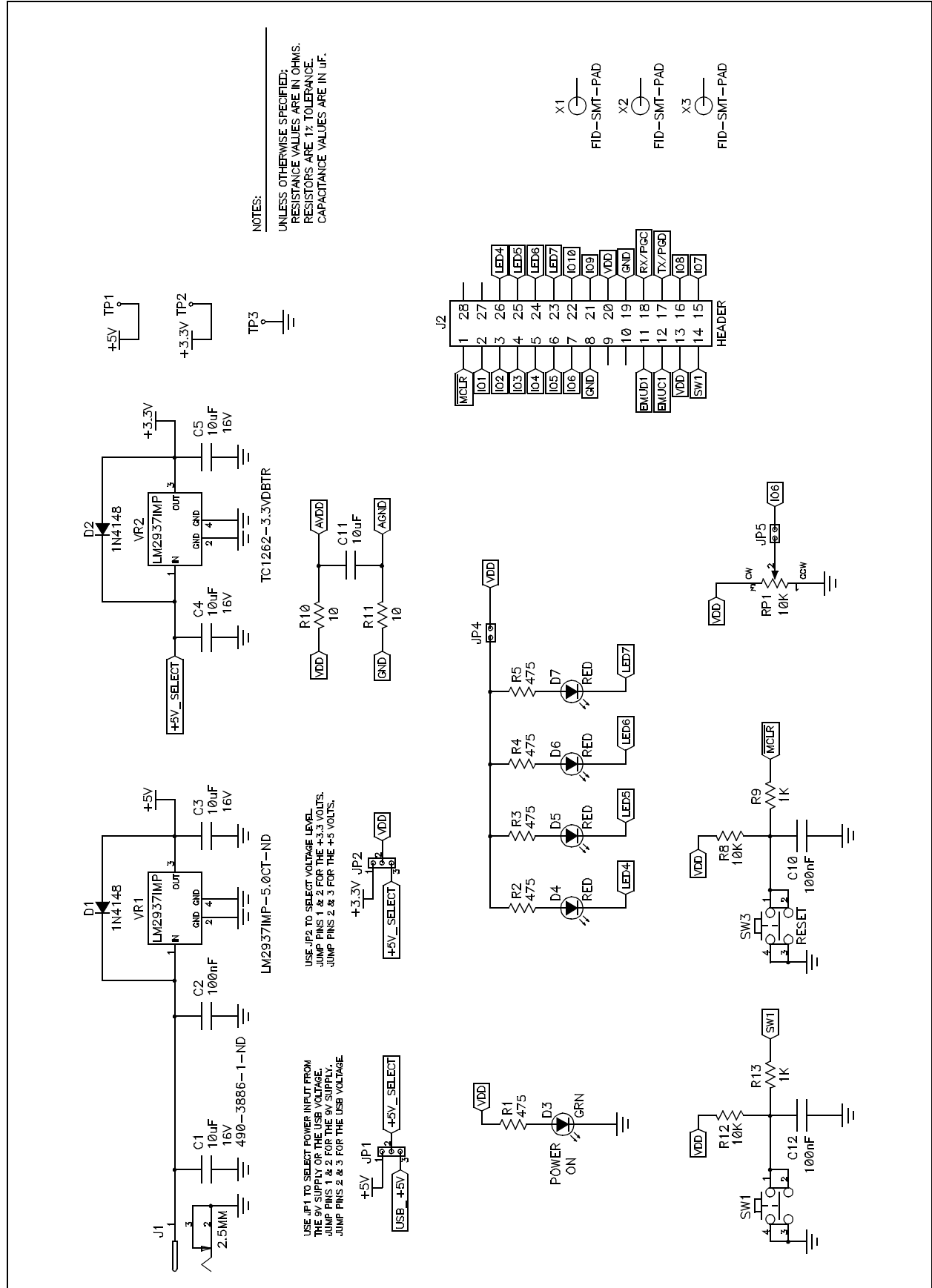

FIGURE A-3: 16-BIT 28-PIN STARTER DEVELOPMENT BOARD SCHEMATIC (SHEET 2 OF 2)



16-Bit 28-Pin Starter Development Board User's Guide

NOTES:

Appendix B. Bill of Materials (BOM)

TABLE B-1: BILL OF MATERIALS

Qty	Component Name	Reference	Value	Vendor	Vendor P/N
1	CAP-CRCW0805	C17	1 μ F	Digi-Key	PCC2249CT-ND
5	CAP-CRCW0805	C1	10 μ F	Digi-Key	490-3886-1-ND
		C3	10 μ F		
		C4	10 μ F		
		C5	10 μ F		
		C11	10 μ F		
4	CAP-CRCW0805	C6	20 pF	Digi-Key	478-3735-1-ND
		C7	20 pF		
		C14	20 pF		
		C15	20 pF		
8	CAP-CRCW0805	C2	100 nF	Digi-Key	PCC1864CT-ND
		C8	100 nF		
		C9	100 nF		
		C10	100 nF		
		C12	100 nF		
		C13	100 nF		
		C16	100 nF		
		C18	100 nF		
1	CNN-POWER-IN-MOD-2.5MM	J1	2.5 MM	Digi-Key	CP-102BH-ND
1	CNN-RJ11-ICSP-6-PIN-PTH	J4	RJ11-6-pin	Digi-Key	A31417-ND
1	CNN-USB-TYPE-B-PTH	J3	USB	Digi-Key	A31725-ND
2	DIO-1N4148WS-SOD-323	D1	1N4148	Digi-Key	1N4148WS-FDICT-ND
		D2	1N4148		
4	FOOT-BUMPON-RUBBER-0.375-ROUND	BOM1	BUMPON	Digi-Key	RBS-12-ND
		BOM2			
		BOM3			
		BOM4			
1	HDR-2X14-IC-STYLE	J2	HEADER	Digi-Key	929665-09-36-ND
1	ICP-DUAL-PIC-28-PIN-SDIP	U1	dsPIC33F	MCHP	dsPIC33F
1	ICP-PIC18F2450/ML-QFN-28-PIN-6X6MM	U2	PIC18F2450/ML	MCHP	PIC18F2450/ML
1	IND-1210	L1	60 Ω	Digi-Key	240-2416-1-ND
2	JMP-2PIN-VIAS	JP4	1x2	Jameco	108337
		JP5	1x2		
3	JMP-3PIN-CFG2-VIAS	JP1	1x3	Jameco	109575
		JP2	1x3		
		JP3	1x3		
1	LED-LTST-C150XKT-1206-SMD	D3	GRN	Digi-Key	160-1169-1-ND

16-Bit 28-Pin Starter Development Board User's Guide

TABLE B-1: BILL OF MATERIALS (CONTINUED)

Qty	Component Name	Reference	Value	Vendor	Vendor P/N
4	LED-LTST-C150XKT-1206-SMD	D4	RED	Digi-Key	160-1167-1-ND
		D5			
		D6			
		D7			
1	POT-3352E-BOURNS-1T	RP1	10K	Digi-Key	3352E-103LF-ND
2	RES-CRCW0805	R9	1K	Digi-Key	RHM1.00KCCT-ND
		R13	1K		
1	RES-CRCW0805	R6	1M	Digi-Key	RHM1.00MCCT-ND
2	RES-CRCW0805	R10	10	Digi-Key	RHM10.0CCT-ND
		R11	10		
3	RES-CRCW0805	R7	10K	Digi-Key	RHM10.0KCCT-ND
		R8	10K		
		R12	10K		
5	RES-CRCW0805	R1	475	Digi-Key	RHM475CCT-ND
		R2	475		
		R3	475		
		R4	475		
		R5	475		
2	SWT-B3F1000-MOM-NO-PTH	SW3	RESET	Digi-Key	SW402-ND
		SW1	MOM-NO		
1	SWT-E-SWT-EG2209-VERT-PTH	SW2	PROGRAM	Digi-Key	EG1907-ND
1	TSP-P90R60	TP2	+3.3V - WHI	Digi-Key	5012K-ND
1	TSP-P90R60	TP1	+5V - RED	Digi-Key	5010K-ND
1	TSP-P90R60	TP6	AGND - ORN	Digi-Key	5013K-ND
1	TSP-P90R60	TP5	AVDD - YEL	Digi-Key	5014K-ND
2	TSP-P90R60	TP3	GND - BLK	Digi-Key	5011K-ND
		TP4	GND - BLK		
1	VRG-LM2937IMP-SOT223-SMT	VR1	+5V	Digi-Key	LM2937IMP-5.0CT-ND
1	VRG-TC1262IMP-SOT223-SMT	VR2	+3.3V	MCHP	TC1262-3.3VDBTR
1	XTL-200LS-PTH-CAN	Y1	7.3728 MHz	Digi-Key	X1084-ND
1	XTL-ABM8-SMT	Y2	20.0 MHz	Digi-Key	535-9136-1-ND
1	SOC-PIC-28-PIN-SDIP	SU1	SOCKET	Digi-Key	ED90054-ND
1	PCB-DSPICDEM-28-PIN-PLUS-DEMO	PCB1	BLANK PCB		
5	SHUNT, 2-PIN	SH1-5		Jameco	421454

Index

B	
Board	33
Breakpoint	26
Breakpoint Set	24
C	
Communication Channel	
UART-to-USB	10
Configuration Bits	18
Connections	
MPLAB ICD 2	9
Customer Notification Service	4
Customer Support	5
D	
Debugging	24
Demonstration Program	
Summary	29
UART Communication	29
Development Board Features	
Device Clocking	9
External Stimulus Switches	9
LED Indicators	9
MPLAB ICD 2 Connections	9
Power Supply Circuit	9
Reset Push Button	9
Serial Communication Channels	9
Development Board Power	9
Development Board Schematic	38
Device Clocking	9
Documentation	
Conventions	2
Layout	1
F	
Free Software Foundation	3
G	
GNU Language Tools	3
H	
Hardware	33
+5V or +3.3V Jumper	34
Device Selection Jumper	35
LED Connect Jumper	35
LED Indicators	35
MPLAB ICD 2 Connector	34
Oscillator	35
Potentiometer	35
Potentiometer Connect Jumper	35
Power On Indicator	34
Power Supply Connector	34
Power Supply or USB Jumper	34
Reset Button	35
Switch 1	35
Switch 2	35
USB Port	34
I	
I/O Header	35
Internet Address	4
L	
Language Toolsuite	14
M	
Microchip Internet Web Site	4
MPLAB IDE User's Guide	3
P	
Project Wizard	12
R	
Reading, Recommended	3
Readme	3
S	
Schematics	38, 39
T	
Tutorial	
Building the Code	17
Creating the Project	12
Debugging the Code	24
Equipment Required	12
Overview	11
Programming the Chip	18
Programming the Device for Stand-alone Operation	27
U	
UART Communication Channel	9, 10
W	
Warranty Registration	2
Watch Window	25
Workspace	12
WWW Address	4



MICROCHIP

WORLDWIDE SALES AND SERVICE

AMERICAS

Corporate Office
2355 West Chandler Blvd.
Chandler, AZ 85224-6199
Tel: 480-792-7200
Fax: 480-792-7277
Technical Support:
<http://support.microchip.com>
Web Address:
www.microchip.com

Atlanta
Duluth, GA
Tel: 678-957-9614
Fax: 678-957-1455

Boston
Westborough, MA
Tel: 774-760-0087
Fax: 774-760-0088

Chicago
Itasca, IL
Tel: 630-285-0071
Fax: 630-285-0075

Dallas
Addison, TX
Tel: 972-818-7423
Fax: 972-818-2924

Detroit
Farmington Hills, MI
Tel: 248-538-2250
Fax: 248-538-2260

Kokomo
Kokomo, IN
Tel: 765-864-8360
Fax: 765-864-8387

Los Angeles
Mission Viejo, CA
Tel: 949-462-9523
Fax: 949-462-9608

Santa Clara
Santa Clara, CA
Tel: 408-961-6444
Fax: 408-961-6445

Toronto
Mississauga, Ontario,
Canada
Tel: 905-673-0699
Fax: 905-673-6509

ASIA/PACIFIC

Asia Pacific Office
Suites 3707-14, 37th Floor
Tower 6, The Gateway
Harbour City, Kowloon
Hong Kong
Tel: 852-2401-1200
Fax: 852-2401-3431

Australia - Sydney
Tel: 61-2-9868-6733
Fax: 61-2-9868-6755

China - Beijing
Tel: 86-10-8528-2100
Fax: 86-10-8528-2104

China - Chengdu
Tel: 86-28-8665-5511
Fax: 86-28-8665-7889

China - Fuzhou
Tel: 86-591-8750-3506
Fax: 86-591-8750-3521

China - Hong Kong SAR
Tel: 852-2401-1200
Fax: 852-2401-3431

China - Qingdao
Tel: 86-532-8502-7355
Fax: 86-532-8502-7205

China - Shanghai
Tel: 86-21-5407-5533
Fax: 86-21-5407-5066

China - Shenyang
Tel: 86-24-2334-2829
Fax: 86-24-2334-2393

China - Shenzhen
Tel: 86-755-8203-2660
Fax: 86-755-8203-1760

China - Shunde
Tel: 86-757-2839-5507
Fax: 86-757-2839-5571

China - Wuhan
Tel: 86-27-5980-5300
Fax: 86-27-5980-5118

China - Xian
Tel: 86-29-8833-7250
Fax: 86-29-8833-7256

ASIA/PACIFIC

India - Bangalore
Tel: 91-80-4182-8400
Fax: 91-80-4182-8422

India - New Delhi
Tel: 91-11-4160-8631
Fax: 91-11-4160-8632

India - Pune
Tel: 91-20-2566-1512
Fax: 91-20-2566-1513

Japan - Yokohama
Tel: 81-45-471-6166
Fax: 81-45-471-6122

Korea - Gumi
Tel: 82-54-473-4301
Fax: 82-54-473-4302

Korea - Seoul
Tel: 82-2-554-7200
Fax: 82-2-558-5932 or
82-2-558-5934

Malaysia - Penang
Tel: 60-4-646-8870
Fax: 60-4-646-5086

Philippines - Manila
Tel: 63-2-634-9065
Fax: 63-2-634-9069

Singapore
Tel: 65-6334-8870
Fax: 65-6334-8850

Taiwan - Hsin Chu
Tel: 886-3-572-9526
Fax: 886-3-572-6459

Taiwan - Kaohsiung
Tel: 886-7-536-4818
Fax: 886-7-536-4803

Taiwan - Taipei
Tel: 886-2-2500-6610
Fax: 886-2-2508-0102

Thailand - Bangkok
Tel: 66-2-694-1351
Fax: 66-2-694-1350

EUROPE

Austria - Wels
Tel: 43-7242-2244-39
Fax: 43-7242-2244-393

Denmark - Copenhagen
Tel: 45-4450-2828
Fax: 45-4485-2829

France - Paris
Tel: 33-1-69-53-63-20
Fax: 33-1-69-30-90-79

Germany - Munich
Tel: 49-89-627-144-0
Fax: 49-89-627-144-44

Italy - Milan
Tel: 39-0331-742611
Fax: 39-0331-466781

Netherlands - Drunen
Tel: 31-416-690399
Fax: 31-416-690340

Spain - Madrid
Tel: 34-91-708-08-90
Fax: 34-91-708-08-91

UK - Wokingham
Tel: 44-118-921-5869
Fax: 44-118-921-5820

12/08/06