



SPECIFICATION FOR APPROVAL

File No.: O/FRK 0.GS.E.C42-C14

Product Name Box-type Metallized Polypropylene Film Interference Suppression Capacitor (Class X2)

Product Type MKP62

Product Code C42

Customer

Customer Code

Issue Date 2017-8

Xiamen Faratronic Co. Ltd.			Approved by Customer
Drafted	Checked	Approved	



Xiamen Faratronic Co. Ltd.

Add: 99 Xinyuan Road, Haicang District, Xiamen, China

Marketing/Sales center

TEL: 0086-592-2335737 6208505 6208586

FAX: 0086-592-6208777

Mail: Vivian@faratronic.com.cn

Donny@faratronic.com.cn

James@faratronic.com.cn

Http: www.faratronic.com.cn

*.The specification are the property of Xiamen Faratronic Co.Ltd and shall not be copied or used as commercial purposes without permission.

Version history

Current version	Date	Author	Change description

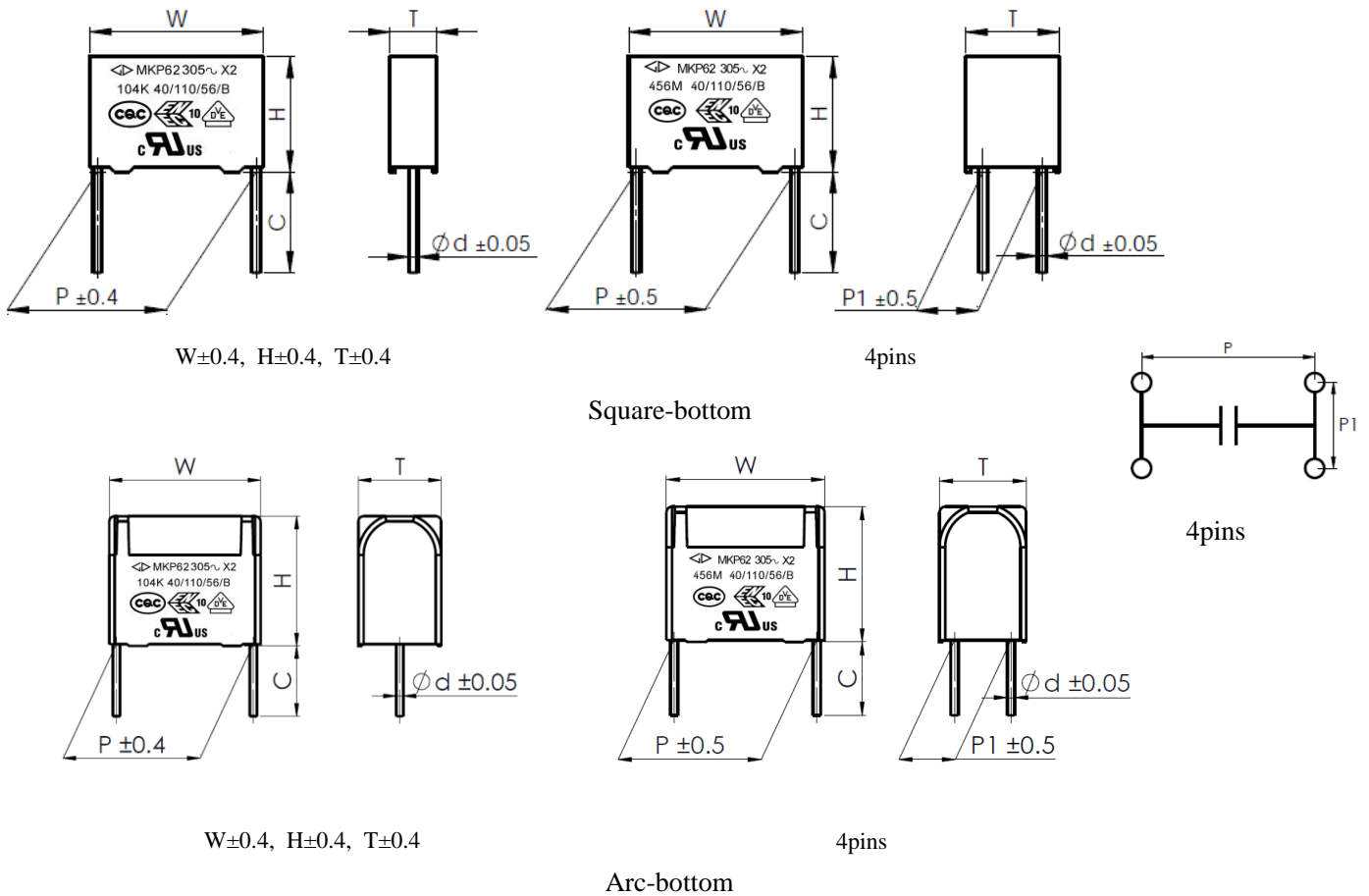
Metallized polypropylene film interference suppression capacitor(Class X2, 305Vac/275Vac)
■ Outline Drawing

■ Features

- Metallized polypropylene structure
- Withstanding overvoltage stressing
- Excellent active and passive flame resistant abilities
- Used in across-the-line, interference suppression circuit.

■ Safety Approvals

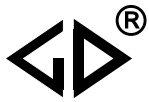
●		CQC	IEC 60384-14:2013, X2, 305Vac/275Vac, 0.0010μF~50.0μF, 40/110/56/B Certificate No.: CQC03001002875
●		ENEC-VDE	EN 60384-14:2013, X2, 305Vac/275Vac, 0.0010μF~50.0μF, 40/110/56/B Certificate No.: 40000358
●		UL-CUL	UL 60384-14:2009, CSA E60384-14:09, X2, 305Vac/275Vac, 0.0010μF~50.0μF, 40/110/56/B File No.: E186600, CCN: FOWX2/8
●		KC	K60384-14(2006-12), X2, 305Vac/275Vac, 0.0010μF~3.0μF, 40/110/56/B Certificate No.: SU03060-12001A/12002/12003/12004



■ Specifications

Class	Class X2		
Climatic Category / Passive Flammability	40/110/56/B		
Operating Temperature Range	-40°C ~ +110°C		
Rated Voltage (U _R)	305Vac/275Vac, 50/60Hz		
Maximum continuous DC voltage	630Vdc		
Capacitance Range	0.0010μF~25.0μF		
Capacitance Tolerance	±10%(K), ±20%(M)		
Voltage Proof	Between Terminals	4.3U _R (dc), 2s	
	Between Terminals To Case	2 120Vac, 1min	
Insulation Resistance	R≥15 000MΩ, C _N ≤0.33μF (20°C, 100V, 1min) RC _N ≥5 000s, C _N >0.33μF		
Dissipation Factor	0.0010μF≤C _N <0.010μF	≤20×10 ⁻⁴ (1kHz,20°C)	≤20×10 ⁻⁴ (10kHz,20°C)
	0.010μF≤C _N <0.47μF	≤10×10 ⁻⁴ (1kHz,20°C)	≤20×10 ⁻⁴ (10kHz,20°C)
	0.47μF≤C _N ≤1.0μF	≤20×10 ⁻⁴ (1kHz,20°C)	≤40×10 ⁻⁴ (10kHz,20°C)
	1.0μF<C _N ≤10.0μF	≤30×10 ⁻⁴ (1kHz,20°C)	-----
	10.0μF<C _N ≤50.0μF	≤40×10 ⁻⁴ (1kHz,20°C)	-----

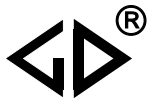

■ Part number system

The 18 digits part number is formed as follow:

1	2	3	4	5	6	7	8	9	10	11	12	13	14	15	16	17	18
C	4	2															

Digit 1 to 3 Series code

C42=MKP62

Digit 4 to 5 A.C. rated voltage

Q2=305V P2=275V

Digit 6 to 8 Rated capacitance value

For example : 103=10×10³ pF= 0.01μF

Digit 9 Capacitance tolerance

K=±10%, M=±20%

Digit 10 Pitch

3=7.5mm 4=10.0mm 6=15.0mm 9=22.5mm

B=27.5mm F=37.5mm M=52.5mm

Digit 11 Internal use

Digit 12 to 15 Lead form and packaging code

Digit 16 to 18 Internal use

Table1 Lead form and packaging code

Digit 12		Digit 13		Digit 14		Digit 15				
code	explanation	code	explanation	code	explanation	code	explanation			
A	ammo-pack	3 4 6	F=7.5mm F=10.0mm F=15.0mm	0	Straight	1 5	each cap. among two consecutive holes P3=12.7mm,H=18.5mm (For P=7.5mm) P3=25.4mm;H=18.5mm (For pitch=10/15mm) (Detail parameter refer to page 11)			
C	straight lead “C” in the figure above	code	explanation		0	0	Length tolerance ±0.5mm or standard length			
		00 45	standard lead length (18mm~26mm) lead length 4.5mm							
D	Insulated stranded leads	C5 K0 K2 L0	35mm	1	1	1	Length tolerance -5 mm~0 mm			
E	Insulated solid leads		100mm				Length tolerance 0 mm~+5 mm			
M	Insulated stranded leads Box with mounting foot		120mm				3	3	3	Length tolerance 0 mm~+10mm
			200mm							4
T 3	P1=20.3mm±0.5mm	45	lead length 4.5mm	0	0	0	Length tolerance ±0.5mm or standard length			
	P1=20mm±0.5mm	55	lead length 5.5mm							

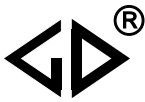

■ Dimensions(mm)

305Vac/275Vac [#]							305Vac/275Vac [#]							305Vac/275Vac [#]						
C _N	W	H	T	P	d	Part number	C _N	W	H	T	P	d	Part number	C _N	W	H	T	P	d	Part number
0.0010	10.5	9.0	4.0	7.5	0.6	C42Q2102-30****+M	0.022	17.5	9.5	5.0	15.0	0.6	C42Q2223-6A****+M	0.39	32.0	18.0	9.0	27.5	0.8	C42Q2394-B0****+M
0.0012	10.5	9.0	4.0	7.5	0.6	C42Q2122-30****+M	0.027	17.5	9.5	5.0	15.0	0.6	C42Q2273-6A****+M	0.47	32.0	18.0	9.0	27.5	0.8	C42Q2474-B0****+M
0.0015	10.5	9.0	4.0	7.5	0.6	C42Q2152-30****+M	0.033	17.5	9.5	5.0	15.0	0.6	C42Q2333-6A****+M	0.56	32.0	18.0	9.0	27.5	0.8	C42Q2564-B0****+M
0.0018	10.5	9.0	4.0	7.5	0.6	C42Q2182-30****+M	0.039	17.5	9.5	5.0	15.0	0.6	C42Q2393-6A****+M	0.68	32.0	18.0	9.0	27.5	0.8	C42Q2684-B0****+M
0.0022	10.5	9.0	4.0	7.5	0.6	C42Q2222-30****+M	0.047	17.5	9.5	5.0	15.0	0.6	C42Q2473-6A****+M	0.82	32.0	18.0	9.0	27.5	0.8	C42Q2824-BS****+M
0.0027	10.5	9.0	4.0	7.5	0.6	C42Q2272-30****+M	0.056	17.5	9.5	5.0	15.0	0.6	C42Q2563-6A****+M	1.0	32.0	18.0	9.0	27.5	0.8	C42Q2105-BS****+M
0.0033	10.5	9.0	4.0	7.5	0.6	C42Q2332-30****+M	0.068	17.5	9.5	5.0	15.0	0.6	C42Q2683-6A****+M	1.0	32.0	12.0	18.0	27.5	0.8	C42Q2105-BC****+M
0.0039	10.5	9.0	4.0	7.5	0.6	C42Q2392-30****+M	0.082	17.5	9.5	5.0	15.0	0.6	C42Q2823-6A****+M	1.2	32.0	20.0	11.0	27.5	0.8	C42Q2125-BS****+M
0.0047	10.5	9.0	4.0	7.5	0.6	C42Q2472-30****+M	0.10M	17.5	9.5	5.0	15.0	0.6	C42Q2104M6A****+M	1.5	32.0	20.0	11.0	27.5	0.8	C42Q2155-BS****+M
0.0056	10.5	9.0	4.0	7.5	0.6	C42Q2562-30****+M	0.10	17.5	11.0	5.0	15.0	0.6	C42Q2104-6S****+M	1.8	32.0	22.0	13.0	27.5	0.8	C42Q2185-BS****+M
0.0068	10.5	9.0	4.0	7.5	0.6	C42Q2682-30****+M	0.12	17.5	11.0	5.0	15.0	0.6	C42Q2124-6S****+M	2.2M	32.0	22.0	13.0	27.5	0.8	C42Q2225MBS****+M
0.0082	10.5	9.0	4.0	7.5	0.6	C42Q2822-30****+M	0.15M	17.5	11.0	5.0	15.0	0.6	C42Q2154M6S****+M	2.2K	32.0	25.0	13.0	27.5	0.8	C42Q2225KBS****+M
0.010	10.5	9.0	4.0	7.5	0.6	C42Q2103-30****+M	0.15K	17.5	12.0	6.0	15.0	0.6	C42Q2154K6S****+M	★2.2	32.0	16.0	22.0	27.5	0.8	C42Q2225-BC****+M
0.012	10.5	9.0	4.0	7.5	0.6	C42Q2123-30****+M	0.18	17.5	12.0	6.0	15.0	0.6	C42Q2184-6S****+M	2.7	32.0	28.0	14.0	27.5	0.8	C42Q2275-BS****+M
0.015	10.5	9.0	4.0	7.5	0.6	C42Q2153-30****+M	0.22M	17.5	12.0	6.0	15.0	0.6	C42Q2224M6S****+M	3.3	32.0	30.0	16.0	27.5	0.8	C42Q2335-BA****+M
0.018	10.5	9.0	4.0	7.5	0.6	C42Q2183-30****+M	0.22K	17.5	13.5	6.0	15.0	0.6	C42Q2224K6B****+M	3.3M	32.0	24.5	15.0	27.5	0.8	C42Q2335MBB****+M
0.022	10.5	9.0	4.0	7.5	0.6	C42Q2223-3S****+M	0.22K	17.5	12.0	7.0	15.0	0.6	C42Q2224K6C****+M	3.3K	32.0	28.0	17.0	27.5	0.8	C42Q2335KCB****+M
0.027	10.5	9.0	4.0	7.5	0.6	C42Q2273-3S****+M	0.22K	17.5	13.5	7.5	15.0	0.6	C42Q2224K6S****+M	★3.3M	32.0	16.0	27.5	27.5	0.8	C42Q2335MBC****+M
0.033	10.5	11.0	5.0	7.5	0.6	C42Q2333-3S****+M	0.27	17.5	13.5	7.5	15.0	0.6	C42Q2274-6S****+M	★3.3K	32.0	18.5	31.0	27.5	0.8	C42Q2335KBC****+M
0.039	10.5	11.0	5.0	7.5	0.6	C42Q2393-3S****+M	0.33M	17.5	13.5	7.5	15.0	0.6	C42Q2334M6S****+M	3.9	32.0	29.0	19.0	27.5	0.8	C42Q2395-BA****+M
0.047	10.5	11.0	5.0	7.5	0.6	C42Q2473-3S****+M	0.33K	17.5	14.0	8.0	15.0	0.6	C42Q2334K6S****+M	3.9	32.0	33.0	18.0	27.5	0.8	C42Q2395-BS****+M
0.056	10.5	12.0	6.0	7.5	0.6	C42Q2563-3S****+M	0.33M	17.5	12.5	9.0	15.0	0.6	C42Q2334M6A****+M	4.7M	32.0	33.0	18.0	27.5	0.8	C42Q2475MBS****+M
0.068	10.5	12.0	6.0	7.5	0.6	C42Q2683-3S****+M	0.33M	17.5	17.5	6.0	15.0	0.6	C42Q2334M6B****+M	★4.7M	32.0	18.5	31.0	27.5	0.8	C42Q2475MBC****+M
0.0047	13.0	9.0	4.0	10.0	0.6	C42Q2472-40****+M	0.33K	17.5	18.5	7.5	15.0	0.8	C42Q2334K6A****+M	4.7K	32.0	33.0	18.0	27.5	0.8	C42Q2475KBA****+M
0.0056	13.0	9.0	4.0	10.0	0.6	C42Q2562-40****+M	0.33	17.5	12.0	13.0	15.0	0.8	C42Q2334-6C****+M	4.7	32.0	30.0	21.0	27.5	0.8	C42Q2475-DB****+M
0.0068	13.0	9.0	4.0	10.0	0.6	C42Q2682-40****+M	0.39	17.5	14.5	8.5	15.0	0.6	C42Q2394-6S****+M	5.6	32.0	37.0	22.0	27.5	0.8	C42Q2565-BS****+M
0.0082	13.0	9.0	4.0	10.0	0.6	C42Q2822-40****+M	0.47M	17.5	14.5	8.5	15.0	0.6	C42Q2474M6S****+M	6.8M	32.0	37.0	22.0	27.5	0.8	C42Q2685MBS****+M
0.010	13.0	9.0	4.0	10.0	0.6	C42Q2103-40****+M	0.47M	17.5	18.5	7.5	15.0	0.8	C42Q2474M6A****+M	1.5	41.0	22.0	11.0	37.5	1.0	C42Q2155-FS****+M
0.012	13.0	9.0	4.0	10.0	0.6	C42Q2123-40****+M	0.47K	17.5	16.0	10.0	15.0	0.8	C42Q2474K6S****+M	1.8	41.0	22.0	11.0	37.5	1.0	C42Q2185-FS****+M
0.015	13.0	9.0	4.0	10.0	0.6	C42Q2153-40****+M	0.56	17.5	16.0	10.0	15.0	0.8	C42Q2564-6A****+M	2.2	41.0	24.0	13.0	37.5	1.0	C42Q2225-FS****+M
0.018	13.0	9.0	4.0	10.0	0.6	C42Q2183-40****+M	0.60	17.5	19.0	11.0	15.0	0.8	C42Q2604-6S****+M	2.2	42.0	15.0	24.0	37.5	1.0	C42Q2225-FC****+M
0.022	13.0	9.0	4.0	10.0	0.6	C42Q2223-40****+M	0.68	17.5	19.0	11.0	15.0	0.8	C42Q2684-6S****+M	2.7	41.0	24.0	13.0	37.5	1.0	C42Q2275-FS****+M
0.027	13.0	9.0	4.0	10.0	0.6	C42Q2273-40****+M	0.82M	17.5	19.0	11.0	15.0	0.8	C42Q2824M6S****+M	3.3	41.0	26.0	15.0	37.5	1.0	C42Q2335-FA****+M
0.033	13.0	9.0	4.0	10.0	0.6	C42Q2333-4S****+M	0.15	26.5	15.0	6.0	22.5	0.8	C42Q2154-90****+M	3.3	42.0	28.0	14.0	37.5	1.0	C42Q2335-FS****+M
0.039	13.0	9.0	4.0	10.0	0.6	C42Q2393-4S****+M	0.18	26.5	15.0	6.0	22.5	0.8	C42Q2184-90****+M	3.3	42.0	15.0	24.0	37.5	1.0	C42Q2335-FC****+M
0.047	13.0	9.0	4.0	10.0	0.6	C42Q2473-4S****+M	0.22	26.5	15.0	6.0	22.5	0.8	C42Q2224-9S****+M	3.9	41.0	30.0	16.0	37.5	1.0	C42Q2395-FS****+M
0.056	13.0	11.0	5.0	10.0	0.6	C42Q2563-4S****+M	0.27	26.5	15.0	6.0	22.5	0.8	C42Q2274-9S****+M	4.7M	42.0	19.0	24.0	37.5	1.0	C42Q2475MFC****+M
0.068	13.0	11.0	5.0	10.0	0.6	C42Q2683-4S****+M	0.33	26.5	15.0	6.0	22.5	0.8	C42Q2334-9S****+M	4.7K	41.0	20.0	26.0	37.5	1.0	C42Q2475KFC****+M
0.082	13.0	11.0	5.0	10.0	0.6	C42Q2823-4S****+M	0.39	26.5	15.0	6.0	22.5	0.8	C42Q2394-9S****+M	4.7	41.0	30.0	16.0	37.5	1.0	C42Q2475-FS****+M
0.10M	13.0	11.0	5.0	10.0	0.6	C42Q2104M4S****+M	0.47M	26.5	15.0	6.0	22.5	0.8	C42Q2474M9S****+M	5.6	41.0	33.5	18.5	37.5	1.0	C42Q2565-FS****+M
0.10K	13.0	12.0	6.0	10.0	0.6	C42Q2104K4S****+M	0.47K	26.5	16.0	7.0	22.5	0.8	C42Q2474K9S****+M	6.8	41.0	33.5	18.5	37.5	1.0	C42Q2685-FS****+M
0.12	13.0	13.0	7.0	10.0	0.6	C42Q2124-4S****+M	0.56	26.5	16.0	7.0	22.5	0.8	C42Q2564-9S****+M	6.8	42.0	24.0	32.0	37.5	1.0	C42Q2685-FC****+M
0.15	13.0	13.0	7.0	10.0	0.6	C42Q2154-4S****+M	0.60	26.5	17.0	8.5	22.5	0.8	C42Q2604-9S****+M	8.2	41.0	37.0	22.0	37.5	1.0	C42Q2825-FS****+M
0.18	13.0	14.0	8.0	10.0	0.6	C42Q2184-4S****+M	0.68	26.5	17.0	8.5	22.5	0.8	C42Q2684-9S****+M	10.0M	41.0	37.0	22.0	37.5	1.0	C42Q2106MFS****+M
0.22M	13.0	14.0	8.0	10.0	0.6	C42Q2224M4S****+M	0.82	26.5	18.5	10.0	22.5	0.8	C42Q2824-9S****+M	10.0K	41.0	41.0	26.0	37.5	1.0	C42Q2106KFS****+M
0.010	17.5	9.5	5.0	15.0	0.6	C42Q2103-6A****+M	1.0	26.5	18.5	10.0	22.5	0.8	C42Q2105-9S****+M	10.0K	41.5	37.5	27.5	37.5	1.0	C42Q2106KFA****+M
0.012	17.5	9.5	5.0	15.0	0.6	C42Q2123-6A****+M	1.2	26.5	20.0	11.0	22.5	0.8	C42Q2125-9S****+M	12.0	41.0	43.0	28.0	37.5	1.0	C42Q2126-FS****+M
0.015	17.5	9.5	5.0	15.0	0.6	C42Q2153-6A****+M	1.5M	26.5	20.0	11.0	22.5	0.8	C42Q2155M9S****+M	15.0	42.0	45.0	30.0	37.5	1.0	C42Q2156-FS****+M
0.018	17.5	9.5	5.0	15.0	0.6	C42Q2183-6A****+M	1.5K	26.5	22.0	12.0	22.5	0.8	C42Q2155K9S****+M	20.0	42.0	57.5	30.0	37.5	1.0	C42Q2206-FS****+M
							1.8	26.5	24.5	15.5	22.5	0.8	C42Q2185-9S****+M	20.0	57.0	45.0	30.0	52.5	1.2	C42Q2206-MST****+M
							2.2	26.5	24.5	15.5	22.5	0.8	C42Q2225-9S****+M	20.0	57.0	30.0	44.0	52.5	1.2	C42Q2206-MCT****+M
							2.2	26.5	29.5	14.5	22.5	0.8	C42Q2225-9A****+M	25.0	57.0	50.0	35.0	52.5	1.2	C42Q2256-MST****+M

Note: 1. “-”=capacitance tolerance code, M=±20%, K=±10%

2. “****”=lead form and packaging mode code (refer to table 1)

3. “#”when the rated voltage is 275Vac, the digit 4~5 is P2.

4. Not for use in series with the mains, the capacitors for series with the mains please refer to A.C. Capacitors for Capacitive Divider.

5. “★” = Arc bottom of the outer shell.

Maximum permissible voltage change per unit of time

Rated Voltage (Vac)	dV/dt(V/us) at 440 Vdc						
	P=7.5mm	P=10mm	P=15mm	P=22.5mm	P=27.5mm	P=37.5mm	P=52.5mm
305	500	500	400	200	150	100	50

Note:

1. Rated voltage pulse slope $(dV/dt)_R$ at rated voltage.
2. If the working voltage (U) is lower than the rated voltage (U_R) , the capacitor can be worked at a higher dV/dt . In this case, the maximum allowed dV/dt is obtain by multiplying the right value with U_R/U .

Impedance Vs. Frequency

TYPICAL GRAPHS

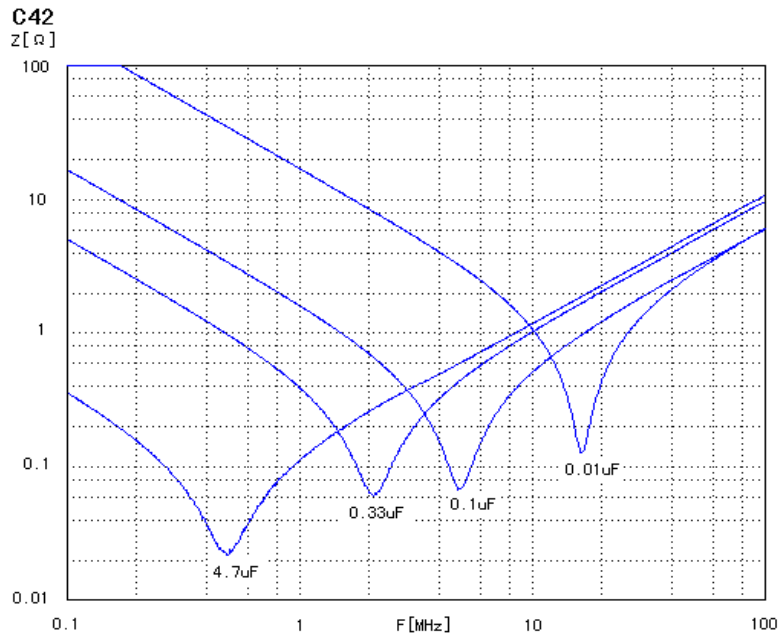
 $Z=f(f)$ Typical values

Quality ensuring test (before shipment):

Inspection item (each batch)	Inspection level (GB/T 2828.1, ISO2859-1)	
	IL	AQL
Appearance inspection	II	1.5%
Dimensions		
Capacitance	II	0.25%
Tangent of the loss angle		
Dielectric strength		
Insulation resistance		
Solderability	S-3	2.5%

■ Test Method And Performance

No.	Item	Performance	Test Method (IEC 60384-14)
1	4.5 Solderability	Good quality of tinning	Solder temperature: 245°C ±5°C Immersion time: 2.0s±0.5s
2	4.3 Terminal strength	There shall be no visible damage	Tense: 0.50<d≤0.80, 10N 0.80<d≤1.25, 20N Bend: 0.50<d≤0.80, 5N 0.80<d≤1.25, 10N The terminals shall be bent 2 times in each direction
3	4.4 Resistance to solder heat	There shall be no visible damage $\Delta C/C \leq \pm 5\%$ (relative to the initial value)	Solder temperature: 260°C ±5°C Immersion time: 10s ±1s
4	4.20 Solvent resistance of the marking	The marking shall be legible	Solvent: Industrial isopropanol. Solvent temperature: 23°C ±5°C Dipping time: 5min ±0.5min Condition: scrub Scrub material: absorbent cotton Reverting time: No
5	4.2 Initial measurement	Capacitance, Tgδ	
	4.6 Rapid change of temperature	There shall be no evidence of deterioration.	T _A =-40°C, T _B =+110°C 5 cycles Duration: t=30min
	4.7 Vibration	There shall be no evidence of deterioration.	Amplitude 0.75mm or acceleration 100m/s ² (whichever is the smaller severity), f: 10Hz to 500Hz. Three directions, 2h for each direction, total 6h.
	4.8 Bump	There shall be no evidence of deterioration.	4 000 times, Acceleration: 400m/s ² , Pulse duration, 6ms
	Final measurement	There shall be no visible damage $\Delta C/C \leq \pm 5\%$ (relative to the initial value)	
6	4.11 Climate sequence	Initial measurement	
		Dry heat	+110°C, 16h
		Damp heat, Cyclic	Test Db, Severity: b, the first cycle
		Cold	-40°C, 2h
		Damp heat, cyclic other	Test Db, Severity b, the other cycles
		Final measurement	There shall be no visible damage, legible marking $\Delta C/C \leq \pm 5\%$ (relative to the initial value) Increase of tgδ: C _N ≤ 1μF: ≤ 0.008 (10kHz) C _N > 1μF: ≤ 0.005 (1kHz) Dielectric strength : there shall be no permanent breakdown or flashover I.R.: ≥ 50% of the rated value



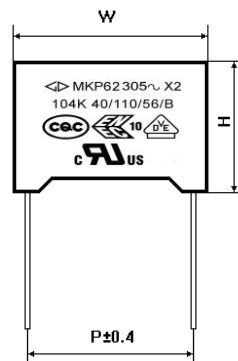

No.	Item	Performance	Test Method (IEC 60384-14)
7	4.12 Damp heat steady state	There shall be no visible damage, legible marking $\Delta C/C \leq \pm 5\%$ (relative to the initial value) Increase of $\text{tg}\delta$: $C_N \leq 1\mu\text{F}$: ≤ 0.008 (10kHz) $C_N > 1\mu\text{F}$: ≤ 0.005 (1kHz) Dielectric strength : there shall be no permanent breakdown or flashover I.R.: $\geq 50\%$ of the rated value	Temperature: $40^\circ\text{C} \pm 2^\circ\text{C}$ Humidity: $93 \pm 3\% \text{RH}$ Duration: 56 days
8	4.13 Impulse voltage	There are three or more waveforms which indicate that no self-heating breakdown have occurred when it is monitored by the monitor	Each individual capacitor shall be subjected to 24 impulses of the same polarity (when any three successive impulses are shown by the monitor to have a wave form indicating that no self-heating breakdown have taken place the impulses can be stopped), the time between impulses shall not be less than 10S, and the peak value of the voltage impulse: 2.5kV (suitable for $C_N \leq 1\mu\text{F}$; When $C_N > 1\mu\text{F}$, the capacitor can endure pulse voltage value is $2.5/\sqrt{C_N}$ kV)
9	4.14 Endurance	There shall be no visible damage, legible marking $\Delta C/C \leq \pm 10\%$ (relative to the initial value) Increase of $\text{tg}\delta$: $C_N \leq 1\mu\text{F}$: ≤ 0.008 (10kHz) $C_N > 1\mu\text{F}$: ≤ 0.005 (1kHz) Dielectric strength : There shall be no breakdown or flashover I.R. : $\geq 50\%$ of the rated value	$+110^\circ\text{C}$, $1.25U_R$ Va.c., 1 000h The voltage shall be subjected to 1000Vrms for 0.1s every one hour during test.
10	4.15 Charging and discharging	$\Delta C/C \leq \pm 10\%$ (relative to the initial value) Increase of $\text{tg}\delta$: $C_N \leq 1\mu\text{F}$: ≤ 0.008 (10kHz) $C_N > 1\mu\text{F}$: ≤ 0.005 (1kHz) I.R.: $\geq 50\%$ of the rated value	Times: 10 000 Duration of charging: 0.5s Duration of discharging: 0.5s Charging voltage: $\sqrt{2} U_R$ Vd.c. Charging resistance: $220/C_N(\Omega)$ or the current $\leq 1.0\text{A}$ (whichever is the minor) Discharging resistance: $R = \frac{\sqrt{2}U_R}{C_N \times \frac{dU}{dt}} (\Omega)$ C_N : Capacitance (μF) dU/dt (V/us) : 100V/ μs
11	4.17 Passive flammability	The flaming time of each capacitor shall not go beyond 10s after it is taken apart from the flame. Drop of each capacitor caused by flame shall not fire the tissue below.	Ref.item 4.17 Needle flame test The category of flammability: B Expose time: 1 time Capacitor Volume Exposing time $250 < V(\text{mm}^3) \leq 500$ 20s $500 < V(\text{mm}^3) \leq 1750$ 30s $V(\text{mm}^3) > 1750$ 60s

No.	Item	Performance	Test Method (IEC 60384-14)
12	4.18 Active flammability	The cheese cloth around the capacitor shall not burn with a flame.	The specimens shall be individually wrapped in at least 1, but not more than 2, complete layers of cheesecloth, the cheesecloth shall be untreated pure cotton cloth. Each sample shall be subjected to 20 discharges, the interval between successive discharges shall be 5s. $U_i = 2.5kV_0^{+7\%}$ U_R be applied and be maintained for 120_0^{+10} s after the last discharge.

■ Marking



Marking Introduction

Sign	explain	Sign	explain
	Brand	40/110/56/B	Climate category / Passive Flammability Class
MKP62	Type		ENEC-VDE Approval
305~	Rated voltage		CQC Approval
X2	Class		UL, CUL Approval
104K	Rated capacitance and tolerance		

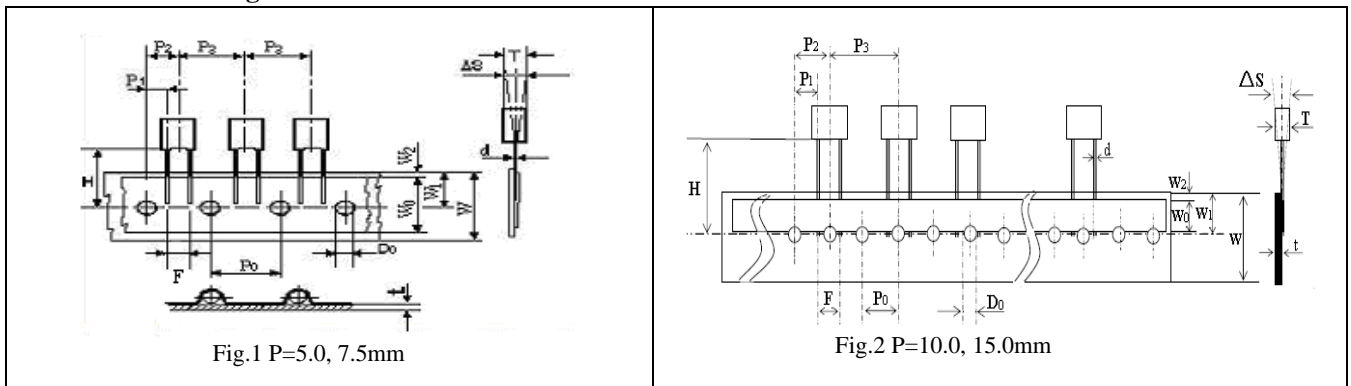
■ Taping specification for box-type capacitors
▲ Outline Drawing

▲ Taping Dimensions(mm)

Technology index title	Code	Dimensions				Tolerance
		P=5.0	P=7.5	P=10.0	P=15.0	
Taping type	—	Fig 1	Fig 1	Fig2	Fig 2	—
Part number Digit12-15	Ammo-pack	A201	A301	A405	A605	
Taping pitch	P ₃	12.7	12.7	25.4	25.4	±1.0
Feed hole pitch	P ₀	12.7	12.7	12.7	12.7	±0.3
Center of wire	P ₁	3.85	2.6	7.7	5.2	±0.7
Center of body	P ₂	6.35	6.35	12.7	12.7	±1.3
Pitch of taping wire	F**	5.0	7.5	10.0	15.0	+0.6 -0.1
Component alignment	△S	0	0	0	0	±2.0
Height of component from tape center	H***	18.5	18.5	18.5	18.5	±0.5
Carrier tape width	W	18.0	18.0	18.0	18.0	+1.0 -0.5
Hold down tape width	W ₀	6min	10min	10min	10min	—
Hole position	W ₁	9.0	9.0	9.0	9.0	±0.5
Hold down tape position	W ₂	3max	3max	3max	3max	—
Feed hole dia.	D ₀	4.0	4.0	4.0	4.0	±0.2
Tape thickness	t	0.7	0.7	0.7	0.7	±0.2

▲ Packing Quantity

Pitch (mm)	Box thickness T(mm)	Ammo-pack (pcs/box)	
		Domestic	Export
5.0	2.5	2500	2 000
	3.5	1 700	1 500
	4.5	1 400	1 300
	5.0	1 200	1 000
	6.0	1 000	800
7.5	3.5	1 700	1 500
	4.0	1 500	1 350
	5.0	1 200	1 050
	6.0	1 000	850
10.0/ 15.0	4.0	750	650
	5.0	600	500
	6.0	500	450
15.0	7.5	400	350
	8.5	350	300
	10.0	300	250
	11.0	250	220

Note: * P₀=15mm is also available;

**F can be other lead spacing;

***H=16.5mm is available;

■ Packing box sizes(mm)

1. Out packing box for bulk

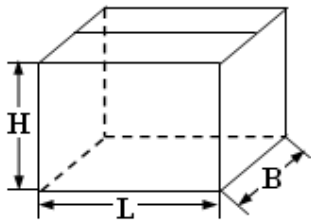

L:375±5
B:375±5
H:265±5

2. Inner packing box for bulk

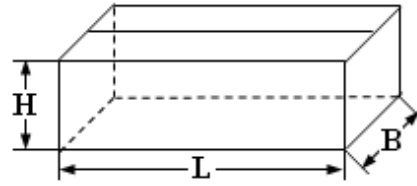

L:355±3
B:175±3
H:118±3

3. Box sizes for Ammo-pack

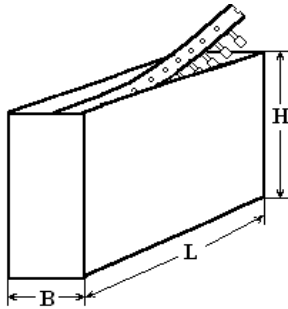

L:330±3
B:48±3
H:260±3