



# AiP74LVC2G17

## Dual Buffer Schmitt Trigger

### Product Specification

#### Specification Revision History:

Version	Date	Description
2019-05-A1	2019-05	New
2021-05-A2	2021-05	Modify Transfer Characteristics Parameter
2021-10-A3	2021-10	Modify ambient temperature to $-40^{\circ}\text{C}\sim+105^{\circ}\text{C}$ and add electrical characteristics of $-40^{\circ}\text{C}\sim+105^{\circ}\text{C}$ ; Modify ordering information
2021-12-A4	2021-12	Modify ordering information
2022-03-A5	2022-03	Modify ordering information note 1



## 1、 General Description

The AiP74LVC2G17 provides two non-inverting buffers with Schmitt trigger input. It is capable of transforming slowly changing input signals into sharply defined, jitter-free output signals.

Inputs can be driven from either 3.3V or 5V devices. This feature allows the use of these devices as translators in a mixed 3.3V and 5V environment.

This device is fully specified for partial power-down applications using  $I_{OFF}$ .

The  $I_{OFF}$  circuitry disables the output, preventing the damaging backflow current through the device when it is powered down.

### Features:

- Wide supply voltage range from 1.65V to 5.5V
- 5V tolerant inputs for interfacing with 5V logic
- $\pm 24\text{mA}$  output drive ( $V_{CC}=3.0\text{V}$ )
- CMOS low power consumption
- Latch-up performance exceeds 250mA
- Direct interface with TTL levels
- Specified from  $-40^{\circ}\text{C}$  to  $+105^{\circ}\text{C}$
- Packaging information: SOT-23-6/SOT-363

### Ordering Information:

#### Reel packing specifications:

Part number	Packaging form	Marking code	Reel quantity	Boxed reel quantity	Notes
AiP74LVC2G17GB236.TR	SOT-23-6	BIXX	3000 PCS/reel	30000 PCS/box	Dimensions of plastic enclosure: 2.9mm×1.6mm Pin spacing: 0.95mm
AiP74LVC2G17GC363.TR	SOT-363	BIXX	3000 PCS/reel	30000 PCS/box	Dimensions of plastic enclosure: 2.1mm×1.3mm Pin spacing: 0.65mm

Note 1: "XX" refers to variable content, meaning year and package batch serial number.

Note 2: If the physical information is inconsistent with the ordering information, please refer to the actual product.



## 2、Block Diagram And Pin Description

### 2.1、Block Diagram

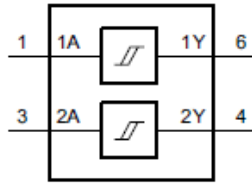

Figure 1. Logic symbol

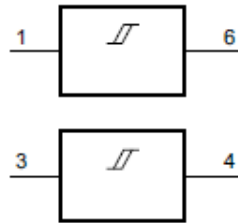

Figure 2. IEC logic symbol

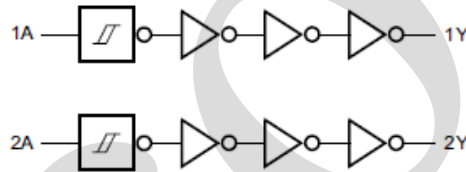
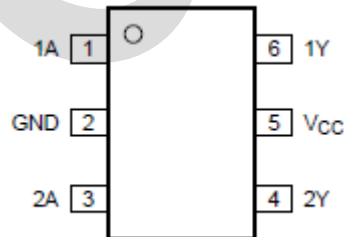

Figure 3. Logic diagram

### 2.2、Pin Configurations



### 2.3、Pin Description

Pin No.	Pin Name	Description
1	1A	data input
2	GND	ground (0V)
3	2A	data input
4	2Y	data output
5	V <sub>CC</sub>	supply voltage
6	1Y	data output



## 2.4、Function Table<sup>[1]</sup>

Input	Output
nA	nY
L	L
H	H

Note: [1] H=HIGH voltage level; L=LOW voltage level.

## 3、Electrical Parameter

### 3.1、Absolute Maximum Ratings

(Voltages are referenced to GND(ground=0V), unless otherwise specified.)

Parameter	Symbol	Conditions	Min.	Max.	Unit
supply voltage	$V_{CC}$	-	-0.5	+6.5	V
input clamping current	$I_{IK}$	$V_I < 0V$	-	-50	mA
input voltage	$V_I$	-	-0.5	+6.5	V
output clamping current	$I_{OK}$	$V_O < 0V$	-	-50	mA
output voltage	$V_O$	Active mode <sup>[1]</sup>	-0.5	$V_{CC}+0.5$	V
		Power-down mode <sup>[1]</sup>	-0.5	+6.5	V
output current	$I_O$	$V_O=0V$ to $V_{CC}$	-	$\pm 50$	mA
supply current	$I_{CC}$	-	-	100	mA
ground current	$I_{GND}$	-	-	-100	mA
storage temperature	$T_{stg}$	-	-65	+150	°C
total power dissipation	$P_{tot}$	-	-	300	mW
Soldering temperature	$T_L$	10s	250		°C

Note: [1] When  $V_{CC}=0V$  (Power-down mode), the output voltage can be 5.5V in normal operation.

### 3.2、Recommended Operating Conditions

Parameter	Symbol	Conditions	Min.	Typ.	Max.	Unit
supply voltage	$V_{CC}$	-	1.65	-	5.5	V
input voltage	$V_I$	-	0	-	5.5	V
output voltage	$V_O$	-	0	-	$V_{CC}$	V
ambient temperature	$T_{amb}$	-	-40	-	+105	°C



## 3.3、Electrical Characteristics

### 3.3.1、DC Characteristics 1

( $T_{amb} = -40^{\circ}\text{C}$  to  $+85^{\circ}\text{C}$ , voltages are referenced to GND (ground=0V), unless otherwise specified.)<sup>[1]</sup>

Parameter	Symbol	Conditions	Min.	Typ.	Max.	Unit	
HIGH-level output voltage	$V_{OH}$	$V_I = V_{T+}$ or $V_{T-}$	$I_O = -100\mu\text{A}; V_{CC} = 1.65\text{V to } 5.5\text{V}$	$V_{CC} - 0.1$	-	-	V
			$I_O = -4\text{mA}; V_{CC} = 1.65\text{V}$	1.2	-	-	V
			$I_O = -8\text{mA}; V_{CC} = 2.3\text{V}$	1.9	-	-	V
			$I_O = -12\text{mA}; V_{CC} = 2.7\text{V}$	2.2	-	-	V
			$I_O = -24\text{mA}; V_{CC} = 3.0\text{V}$	2.3	-	-	V
			$I_O = -32\text{mA}; V_{CC} = 4.5\text{V}$	3.8	-	-	V
LOW-level output voltage	$V_{OL}$	$V_I = V_{T+}$ or $V_{T-}$	$I_O = 100\mu\text{A}; V_{CC} = 1.65\text{V to } 5.5\text{V}$	-	-	0.10	V
			$I_O = 4\text{mA}; V_{CC} = 1.65\text{V}$	-	-	0.45	V
			$I_O = 8\text{mA}; V_{CC} = 2.3\text{V}$	-	-	0.30	V
			$I_O = 12\text{mA}; V_{CC} = 2.7\text{V}$	-	-	0.40	V
			$I_O = 24\text{mA}; V_{CC} = 3.0\text{V}$	-	-	0.55	V
			$I_O = 32\text{mA}; V_{CC} = 4.5\text{V}$	-	-	0.55	V
input leakage current	$I_I$	$V_I = 5.5\text{V or GND}; V_{CC} = 5.5\text{V}$	-	$\pm 0.1$	$\pm 1$	$\mu\text{A}$	
power-off leakage current	$I_{OFF}$	$V_I$ or $V_O = 5.5\text{V}; V_{CC} = 0\text{V}$	-	$\pm 0.1$	$\pm 2$	$\mu\text{A}$	
supply current	$I_{CC}$	$V_I = V_{CC}$ or $\text{GND}; I_O = 0\text{A}; V_{CC} = 5.5\text{V}$	-	0.1	4	$\mu\text{A}$	
additional supply current	$\Delta I_{CC}$	$V_I = V_{CC} - 0.6\text{V}; I_O = 0\text{A}; V_{CC} = 2.3\text{V to } 5.5\text{V}$	-	5	500	$\mu\text{A}$	
input capacitance	$C_I$	-	-	3.5	-	pF	

Note: [1] All typical values are measured at  $V_{CC} = 3.3\text{V}$  and  $T_{amb} = 25^{\circ}\text{C}$ .



### 3.3.2、DC Characteristics 2

( $T_{amb}=-40^{\circ}\text{C}$  to  $+105^{\circ}\text{C}$ , voltages are referenced to GND (ground=0V), unless otherwise specified.)<sup>[1]</sup>

Parameter	Symbol	Conditions	Min.	Typ.	Max.	Unit	
HIGH-level output voltage	$V_{OH}$	$V_I = V_{T+}$ or $V_{T-}$	$I_O=-100\mu\text{A}; V_{CC}=1.65\text{V to }5.5\text{V}$	$V_{CC} - 0.1$	-	-	V
			$I_O=-4\text{mA}; V_{CC}=1.65\text{V}$	0.95	-	-	V
			$I_O=-8\text{mA}; V_{CC}=2.3\text{V}$	1.7	-	-	V
			$I_O=-12\text{mA}; V_{CC}=2.7\text{V}$	1.9	-	-	V
			$I_O=-24\text{mA}; V_{CC}=3.0\text{V}$	2.0	-	-	V
			$I_O=-32\text{mA}; V_{CC}=4.5\text{V}$	3.4	-	-	V
LOW-level output voltage	$V_{OL}$	$V_I = V_{T+}$ or $V_{T-}$	$I_O=100\mu\text{A}; V_{CC}=1.65\text{V to }5.5\text{V}$	-	-	0.10	V
			$I_O=4\text{mA}; V_{CC}=1.65\text{V}$	-	-	0.70	V
			$I_O=8\text{mA}; V_{CC}=2.3\text{V}$	-	-	0.45	V
			$I_O=12\text{mA}; V_{CC}=2.7\text{V}$	-	-	0.60	V
			$I_O=24\text{mA}; V_{CC}=3.0\text{V}$	-	-	0.80	V
			$I_O=32\text{mA}; V_{CC}=4.5\text{V}$	-	-	0.80	V
input leakage current	$I_I$	$V_I=5.5\text{V}$ or GND; $V_{CC}=5.5\text{V}$	-	$\pm 0.1$	$\pm 1$	$\mu\text{A}$	
power-off leakage current	$I_{OFF}$	$V_I$ or $V_O=5.5\text{V}; V_{CC}=0\text{V}$	-	-	$\pm 2$	$\mu\text{A}$	
supply current	$I_{CC}$	$V_I=V_{CC}$ or GND; $I_O=0\text{A}; V_{CC}=5.5\text{V}$	-	-	4	$\mu\text{A}$	
additional supply current	$\Delta I_{CC}$	$V_I=V_{CC}-0.6\text{V}; I_O=0\text{A}; V_{CC}=2.3\text{V to }5.5\text{V}$	-	-	500	$\mu\text{A}$	

Note: [1] All typical values are measured at  $V_{CC}=3.3\text{V}$  and  $T_{amb}=25^{\circ}\text{C}$ .

### 3.3.3、AC Characteristics 1

( $T_{amb}=-40^{\circ}\text{C}$  to  $+85^{\circ}\text{C}$ , voltages are referenced to GND (ground=0V), unless otherwise specified.)

Parameter	Symbol	Conditions	Min.	Typ. <sup>[1]</sup>	Max.	Unit	
nA to nY propagation delay	$t_{pd}$	see Figure 5 <sup>[2]</sup>	$V_{CC}=1.65\text{V to }1.95\text{V}$	1.5	5.6	10.5	ns
			$V_{CC}=2.3\text{V to }2.7\text{V}$	1.0	3.7	6.5	ns
			$V_{CC}=2.7\text{V}$	1.0	3.8	6.5	ns
			$V_{CC}=3.0\text{V to }3.6\text{V}$	1.0	3.6	5.7	ns
			$V_{CC}=4.5\text{V to }5.5\text{V}$	1.0	2.7	4.3	ns
Power dissipation capacitance	$C_{PD}$	per buffer; $V_{CC}=3.3\text{V};$ <sup>[3]</sup> $V_I=\text{GND to }V_{CC}$	-	16.3	-	pF	

Note:

[1] Typical values are measured at  $T_{amb}=25^{\circ}\text{C}$  and  $V_{CC}=1.8\text{V}, 2.5\text{V}, 2.7\text{V}, 3.3\text{V}$  and  $5.0\text{V}$  respectively.

[2]  $t_{pd}$  is the same as  $t_{PLH}$  and  $t_{PHL}$ .

[3]  $C_{PD}$  is used to determine the dynamic power dissipation ( $P_D$  in  $\mu\text{W}$ ).

$$P_D = C_{PD} \times V_{CC}^2 \times f_i \times N + \sum (C_L \times V_{CC}^2 \times f_o) \text{ where:}$$

$f_i$ =input frequency in MHz;

$f_o$ =output frequency in MHz;

$C_L$ =output load capacitance in pF;



$V_{CC}$ =supply voltage in V;

N=number of inputs switching;

$\Sigma(C_L \times V_{CC}^2 \times f_o)$ =sum of outputs.

### 3.3.4、AC Characteristics 2

( $T_{amb}=-40^{\circ}\text{C}$  to  $+105^{\circ}\text{C}$ , voltages are referenced to GND (ground=0V), unless otherwise specified.)

Parameter	Symbol	Conditions	Min.	Typ. <sup>[1]</sup>	Max.	Unit	
nA to nY propagation delay	$t_{pd}$	see Figure 5 <sup>[2]</sup>	$V_{CC}=1.65\text{V}$ to $1.95\text{V}$	1.5	-	13.1	ns
			$V_{CC}=2.3\text{V}$ to $2.7\text{V}$	1.0	-	8.5	ns
			$V_{CC}=2.7\text{V}$	1.0	-	8.5	ns
			$V_{CC}=3.0\text{V}$ to $3.6\text{V}$	1.0	-	7.1	ns
			$V_{CC}=4.5\text{V}$ to $5.5\text{V}$	1.0	-	5.4	ns

Note:

[1] Typical values are measured at  $T_{amb}=25^{\circ}\text{C}$  and  $V_{CC}=1.8\text{V}$ ,  $2.5\text{V}$ ,  $2.7\text{V}$ ,  $3.3\text{V}$  and  $5.0\text{V}$  respectively.

[2]  $t_{pd}$  is the same as  $t_{PLH}$  and  $t_{PHL}$ .

### 3.3.5、Transfer Characteristics 1

( $T_{amb}=-40^{\circ}\text{C}$  to  $+85^{\circ}\text{C}$ , voltages are referenced to GND (ground = 0V), unless otherwise specified.)

Parameter	Symbol	Conditions	Min.	Typ.	Max.	Unit	
positive-going threshold voltage	$V_{T+}$	see Figure 6 and Figure 7	$V_{CC}=1.8\text{V}$	0.82	1.02	1.2	V
			$V_{CC}=2.3\text{V}$	1.03	1.25	1.45	V
			$V_{CC}=3.0\text{V}$	1.29	1.5	1.71	V
			$V_{CC}=4.5\text{V}$	1.84	2.15	2.41	V
			$V_{CC}=5.5\text{V}$	2.19	2.6	2.91	V
negative-going threshold voltage	$V_{T-}$	see Figure 6 and Figure 7	$V_{CC}=1.8\text{V}$	0.45	0.6	0.75	V
			$V_{CC}=2.3\text{V}$	0.64	0.8	0.96	V
			$V_{CC}=3.0\text{V}$	0.86	1.1	1.34	V
			$V_{CC}=4.5\text{V}$	1.35	1.75	2.09	V
			$V_{CC}=5.5\text{V}$	1.61	2.15	2.59	V
hysteresis voltage	$V_H$	$(V_{T+} - V_{T-})$ ; see Figure 6, Figure 7 and Figure 8	$V_{CC}=1.8\text{V}$	0.24	0.4	0.54	V
			$V_{CC}=2.3\text{V}$	0.26	0.4	0.57	V
			$V_{CC}=3.0\text{V}$	0.27	0.42	0.64	V
			$V_{CC}=4.5\text{V}$	0.28	0.45	0.65	V
			$V_{CC}=5.5\text{V}$	0.29	0.47	0.75	V



## 3.3.6、 Transfer Characteristics 2

( $T_{amb}=-40^{\circ}\text{C}$  to  $+105^{\circ}\text{C}$ , voltages are referenced to GND (ground = 0V), unless otherwise specified.)

Parameter	Symbol	Conditions	Min.	Typ.	Max.	Unit	
positive-going threshold voltage	$V_{T+}$	see Figure 6 and Figure 7	$V_{CC}=1.8\text{V}$	0.79	-	1.2	V
			$V_{CC}=2.3\text{V}$	1.00	-	1.45	V
			$V_{CC}=3.0\text{V}$	1.26	-	1.71	V
			$V_{CC}=4.5\text{V}$	1.81	-	2.41	V
			$V_{CC}=5.5\text{V}$	2.16	-	2.91	V
negative-going threshold voltage	$V_{T-}$	see Figure 6 and Figure 7	$V_{CC}=1.8\text{V}$	0.45	-	0.78	V
			$V_{CC}=2.3\text{V}$	0.64	-	0.99	V
			$V_{CC}=3.0\text{V}$	0.86	-	1.37	V
			$V_{CC}=4.5\text{V}$	1.35	-	2.12	V
			$V_{CC}=5.5\text{V}$	1.61	-	2.62	V
hysteresis voltage	$V_H$	$(V_{T+} - V_{T-})$ ; see Figure 6, Figure 7 and Figure 8	$V_{CC}=1.8\text{V}$	0.17	-	0.54	V
			$V_{CC}=2.3\text{V}$	0.20	-	0.57	V
			$V_{CC}=3.0\text{V}$	0.21	-	0.64	V
			$V_{CC}=4.5\text{V}$	0.22	-	0.65	V
			$V_{CC}=5.5\text{V}$	0.23	-	0.75	V

## 4、 Testing Circuit

### 4.1、 AC Testing Circuit

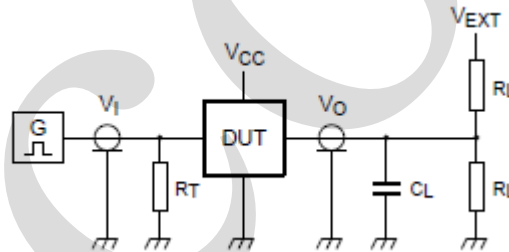

Figure 4. Test circuit for measuring switching times

Definitions for test circuit:

$R_L$ =Load resistance.

$C_L$ =Load capacitance including jig and probe capacitance.

$R_T$ =Termination resistance; should be equal to the output impedance  $Z_o$  of the pulse generator.

$V_{EXT}$ =External voltage for measuring switching times.





### 4.2、 AC Testing Waveforms

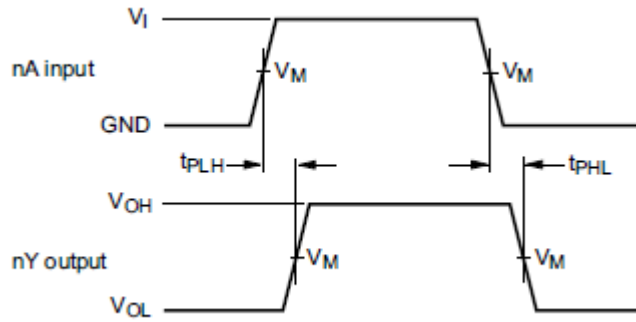

Figure 5. The input nA to output nY propagation delays and the output transition times

### 4.3、 Transfer Characteristics Waveforms

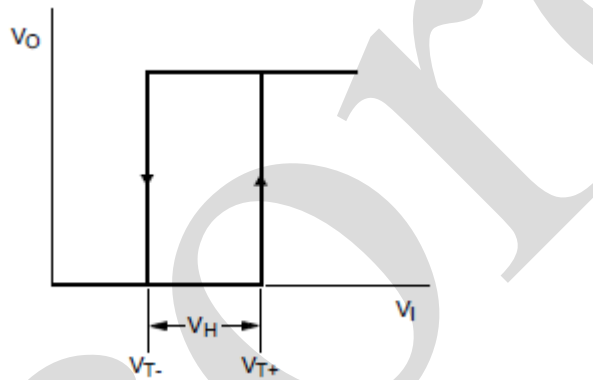

Figure 6. Transfer characteristic

$V_{T+}$  and  $V_{T-}$  limits at 70% and 20%:

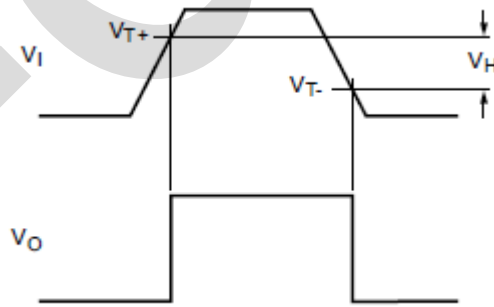

Figure 7. Definition of  $V_{T+}$ ,  $V_{T-}$  and  $V_H$



$V_{CC}=3.0V$ :

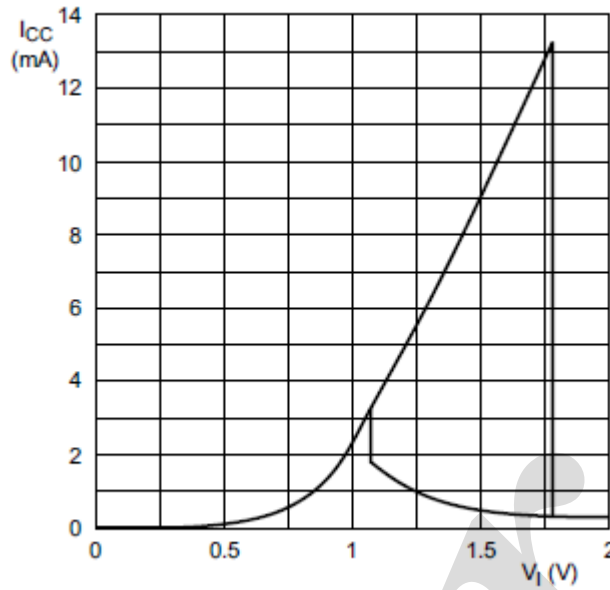

Figure 8. Typical transfer characteristics

#### 4.4、 Measurement Points

Supply voltage	Input	Output
$V_{CC}$	$V_M$	$V_M$
1.65V to 1.95V	$0.5 \times V_{CC}$	$0.5 \times V_{CC}$
2.3V to 2.7V	$0.5 \times V_{CC}$	$0.5 \times V_{CC}$
2.7V	1.5V	1.5V
3.0V to 3.6V	1.5V	1.5V
4.5V to 5.5V	$0.5 \times V_{CC}$	$0.5 \times V_{CC}$

#### 4.5、 Test Data

Supply voltage	Input		Load		$V_{EXT}$
	$V_I$	$t_r = t_f$	$C_L$	$R_L$	$t_{PLH}, t_{PHL}$
1.65V to 1.95V	$V_{CC}$	$\leq 2.0ns$	30pF	1k $\Omega$	open
2.3V to 2.7V	$V_{CC}$	$\leq 2.0ns$	30pF	500 $\Omega$	open
2.7V	2.7V	$\leq 2.5ns$	50pF	500 $\Omega$	open
3.0V to 3.6V	2.7V	$\leq 2.5ns$	50pF	500 $\Omega$	open
4.5V to 5.5V	$V_{CC}$	$\leq 2.5ns$	50pF	500 $\Omega$	open



## 5、Package Information

### 5.1、SOT-23-6

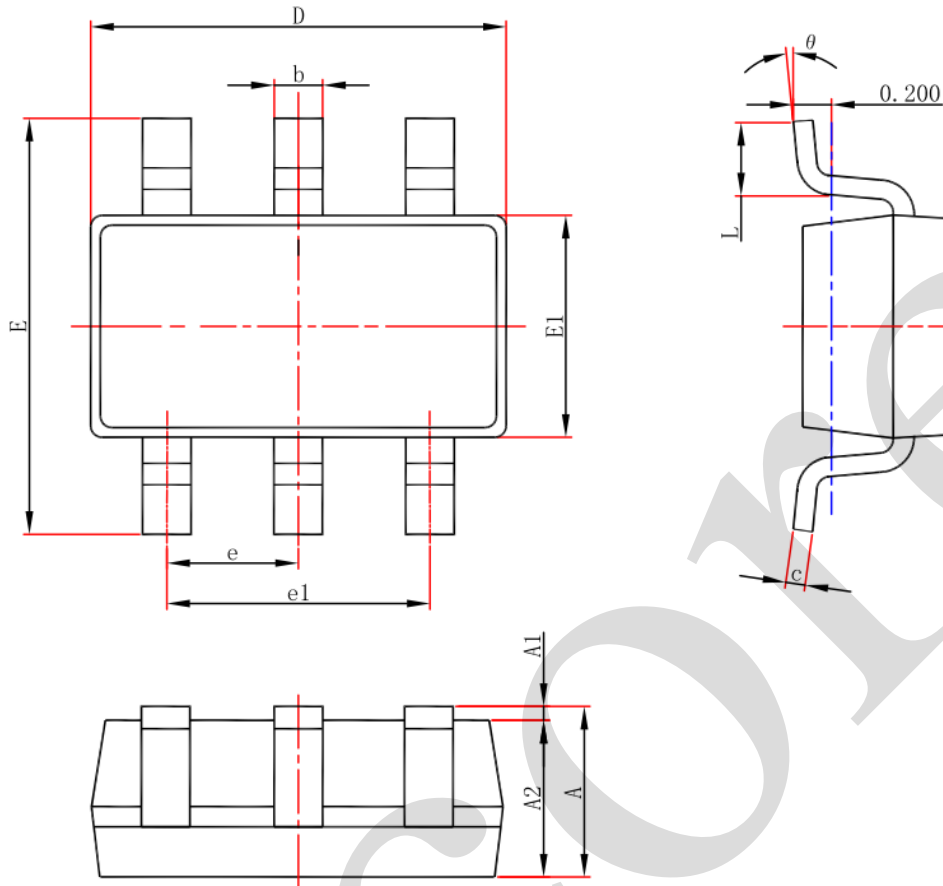

Symbol	Dimensions In Millimeters		Dimensions In Inches	
	Min.	Max.	Min.	Max.
A	1.050	1.250	0.041	0.049
A1	0.000	0.100	0.000	0.004
A2	1.050	1.150	0.041	0.045
b	0.300	0.500	0.012	0.020
c	0.100	0.200	0.004	0.008
D	2.820	3.020	0.111	0.119
E1	1.500	1.700	0.059	0.067
E	2.650	2.950	0.104	0.116
e	0.950(BSC)		0.037(BSC)	
e1	1.800	2.000	0.071	0.079
L	0.300	0.600	0.012	0.024
θ	0°	8°	0°	8°



## 5.2、SOT-363

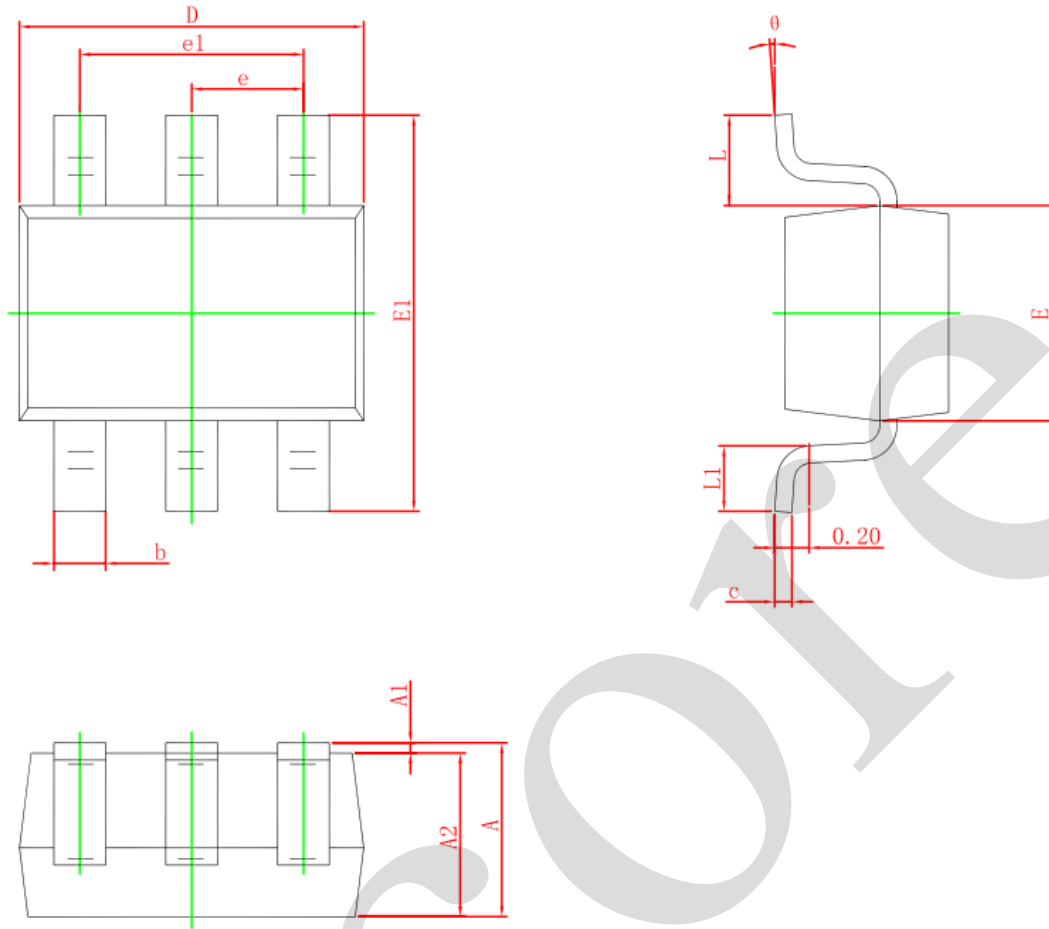

Symbol	Dimensions In Millimeters		Dimensions In Inches	
	Min.	Max.	Min.	Max.
A	0.900	1.100	0.035	0.043
A1	0.000	0.100	0.000	0.004
A2	0.900	1.000	0.035	0.039
b	0.150	0.350	0.006	0.014
c	0.080	0.150	0.003	0.006
D	2.000	2.200	0.079	0.087
E	1.150	1.350	0.045	0.053
E1	2.150	2.450	0.085	0.096
e	0.650 TYP.		0.026 TYP.	
e1	1.200	1.400	0.047	0.055
L	0.525 REF.		0.021 REF.	
L1	0.260	0.460	0.010	0.018
θ	0°	8°	0°	8°



## 6、 Statements And Notes

### 6.1、 The name and content of Hazardous substances or Elements in the product

Part name	Hazardous substances or Elements									
	Lead and lead compounds	Mercury and mercury compounds	Cadmium and cadmium compounds	Hexavalent chromium compounds	Polybrominated biphenyls	Polybrominated biphenyl ethers	Dibutyl phthalate	Butylbenzyl phthalate	Di-2-ethylhexyl phthalate	Diisobutyl phthalate
Lead frame	○	○	○	○	○	○	○	○	○	○
Plastic resin	○	○	○	○	○	○	○	○	○	○
Chip	○	○	○	○	○	○	○	○	○	○
The lead	○	○	○	○	○	○	○	○	○	○
Plastic sheet installed	○	○	○	○	○	○	○	○	○	○
explanation	○: Indicates that the content of hazardous substances or elements in the detection limit of the following the SJ/T11363-2006 standard. ×: Indicates that the content of hazardous substances or elements exceeding the SJ/T11363-2006 Standard limit requirements.									

### 6.2、 Notion

Recommended carefully reading this information before the use of this product;

The information in this document are subject to change without notice;

This information is using to the reference only, the company is not responsible for any loss;

The company is not responsible for the any infringement of the third party patents or other rights of the responsibility.