



# Desiccant Breathers

Defends against moisture and particulate contamination



ENGINEERING YOUR SUCCESS.



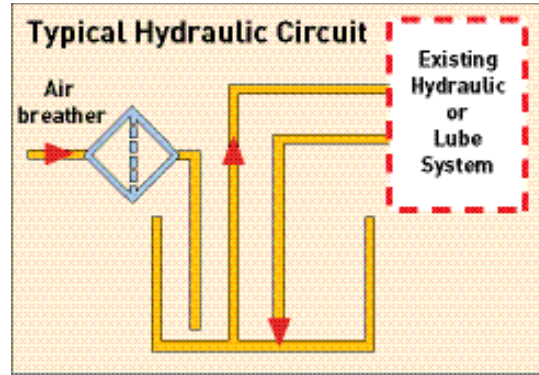

# Desiccant Breathers

## Applications

- Reservoirs
- Mobile Equipment
- Gearboxes
- Transformers
- Storage Tanks
- Totes
- 55 Gallon Drums



The Hydraulic and Fuel Filtration Division's desiccant breather portfolio offers a wide selection of breather designs and desiccant types to deliver optimum performance. Reservoirs open to atmosphere are subject to an array of ambient conditions and require clean dry air on demand.

	<p><b>E Z Dri</b> <i>Zeolite Breather</i></p>	<ul style="list-style-type: none"> <li>• Reduces head space Relative Humidity to as low as 5%</li> <li>• Excellent temperature resistance for &gt;100°F applications</li> <li>• Color indicating beads provide visual identification for service on demand</li> </ul>
	<p><b>TriCeptor</b> <i>Silica Gel Breather</i></p>	<ul style="list-style-type: none"> <li>• Reduces head space Relative Humidity to as low as 20%</li> <li>• Excellent performance in high humidity (&gt;40% RH) environments</li> <li>• Color indicating desiccant provides visual identification for service on demand</li> </ul>
	<p><b>Mobile</b> <i>Rugged Breather</i></p>	<ul style="list-style-type: none"> <li>• E Z Dri or TriCeptor options available</li> <li>• Clean, dry air on demand via high flow check valves to maximize breather life</li> <li>• Rugged construction to withstand the most demanding service</li> </ul>
	<p><b>TriCeptor Plus</b> <i>80% Silica Gel 20% Zeolite</i></p>	<ul style="list-style-type: none"> <li>• Clean, dry air on demand via high flow check valves to maximize breather life</li> <li>• Mixed desiccant provides the ultimate application flexibility</li> <li>• Reduces head space Relative Humidity to as low as 5%</li> <li>• Color indicating desiccant provides visual identification for service on demand</li> </ul>
	<p><b>TriCeptor Extended</b> <i>80% Silica Gel 20% Zeolite</i></p>	<ul style="list-style-type: none"> <li>• Double the capacity of a standard breather</li> <li>• Clean, dry air on demand via high flow check valves to maximize breather life</li> <li>• Mixed desiccant provides the ultimate application flexibility</li> <li>• Reduces head space Relative Humidity to as low as 5%</li> <li>• Color indicating desiccant provides visual identification for service on demand</li> <li>• Integrated oilmist coalescer protects the desiccant from hydrocarbon contaminants</li> </ul>
	<p><b>ClearConnect</b> <i>Wired Relative Humidity Sensor</i></p>	<ul style="list-style-type: none"> <li>• Relative humidity sensor provides realtime system monitoring</li> <li>• Clean, dry air on demand via high flow check valves to maximize breather life</li> <li>• Standard or extended sizes to meet desired service intervals</li> <li>• Clear silica gel desiccant offers up to a 20% improvement in absorption capacity</li> </ul>

# Desiccant Breathers

## Selection Guide

### Features

	EZ Dri	TriCeptor	E Z Dri Mobile	TriCeptor Mobile	TriCeptor Plus	TriCeptor Extended	ClearConnect
Zeolite	x		x	x	x	x	
Color Indicating Silica Gel		x		x	x	x	
Clear Silica Gel							x
Mechanical Adsorption		x		x	x	x	x
1" Multi Fit Threaded Connection	x	x			x		x
1" FNPT Connection						x	x
1 1/2" SAE Connection			x	x			
Clean Air on Demand via high flow check valves				x	x	x	x
Wired Relative Humidity Sensor							x
Rugged Construction			x	x			
Increased Desiccant Volume						x	x
External Ribbing for Change Out	x	x			x		x
Integrated Stand Pipe	x	x	x	x	x	x	x
Honeycomb to Capture Oil Mist						x	x
Headspace RH% Minimized (<5%)	x		x		x	x	
Good for low humidity environments (<40%)	x		x		x	x	
Good for high humidity environments (>40%)		x		x	x	x	x

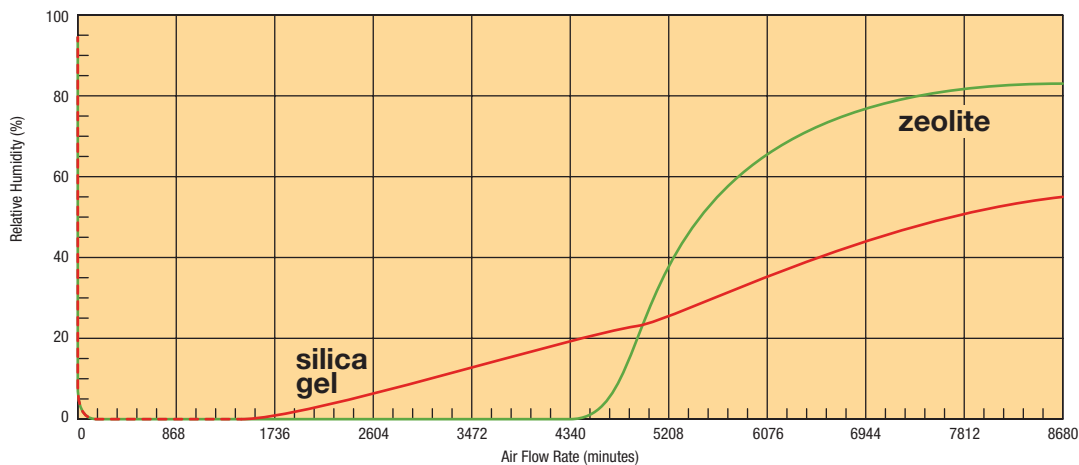
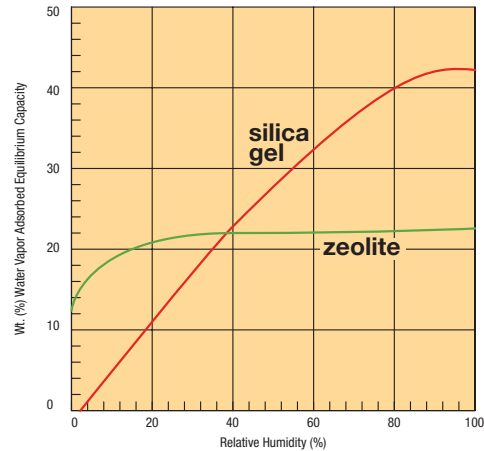
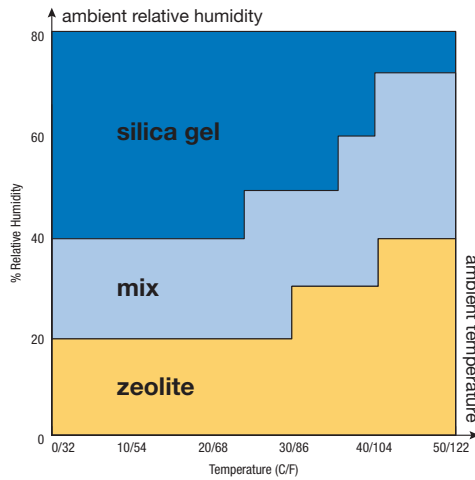

# E Z Dri

## Features

### Materials:

Housing: Polycarbonate, Nylon 6/6 30% Glass Filled, Polypropylene

**Filter Efficiency:** 3 $\mu$  absolute ( $\beta_3 \geq 200$ )

**Operating Temperatures:** -20°F (-29°C) to 200°F (93°C)

**Seals:** Nitrile, PVC



Active

Replace

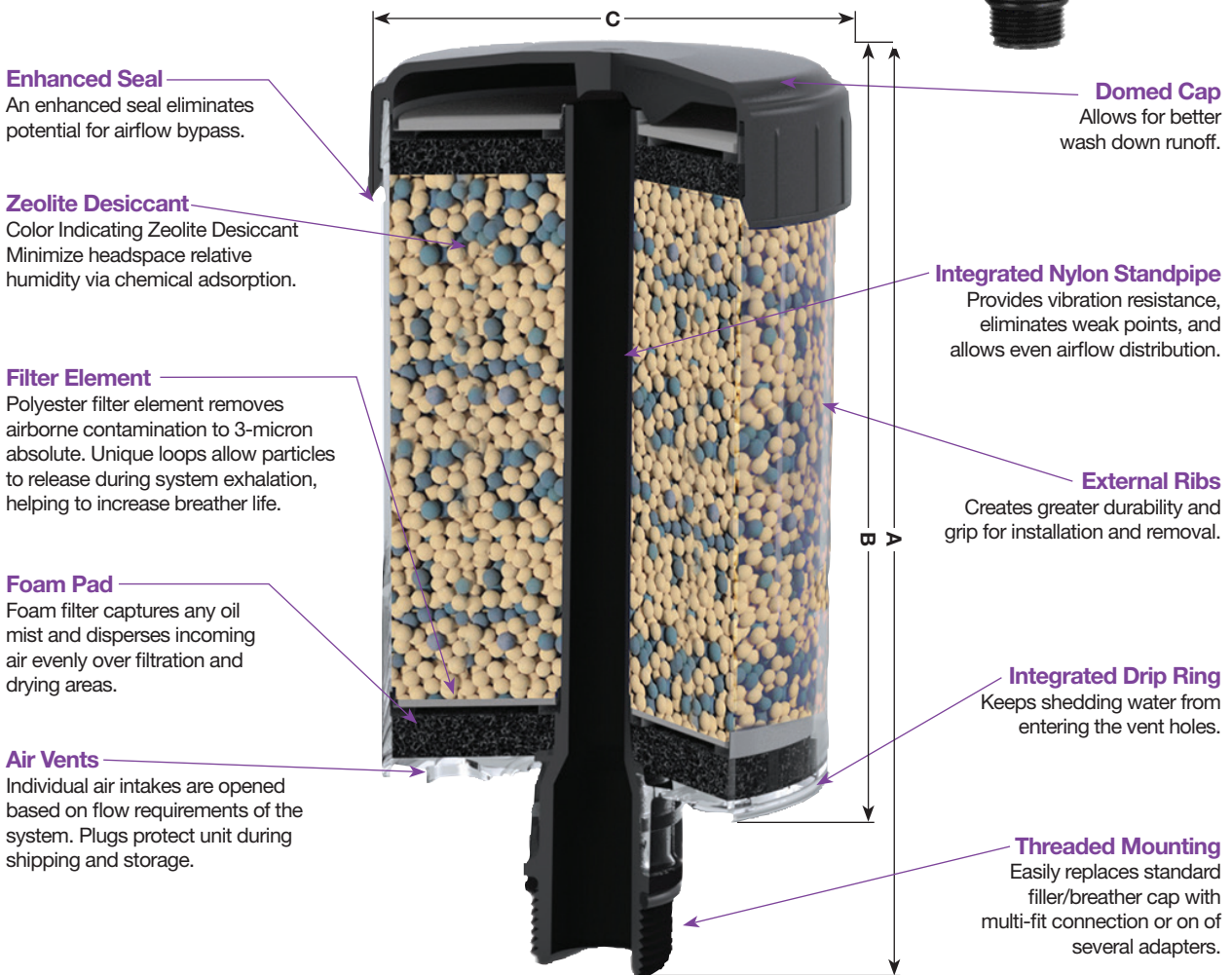

Part Number	A (in/mm)	B (in/mm)	C (in/mm)	Thread	Qty
934330	6.00/152	5.33/135	4.10/104	1" multi-fit male thread with o-ring seal compatible with 1" NPT; 1" NPSM; 1" BSPT; 1" BSPP	6 pcs
934331	8.00/203	7.33/186	4.10/104	1" multi-fit male thread with o-ring seal compatible with 1" NPT; 1" NPSM; 1" BSPT; 1" BSPP	6 pcs
934332	10.00/254	9.33/237	4.10/104	1" multi-fit male thread with o-ring seal compatible with 1" NPT; 1" NPSM; 1" BSPT; 1" BSPP	6 pcs

# E Z Dri

## Specifications

General Data	934330	934331	934332
Amount of ZEOLITE	0.83 lbs	1.33 lbs	1.81 lbs
	.376 kg	.603 kg	0.82 kg
Adsorption Capacity	84 ml	157 ml	209 ml
	2.8 fl oz	5 fl oz	7.1 fl oz
Net Weight of Unit	0.5 kg	0.8 kg	1.1 kg
	1.2 lbs	1.8 lbs	2.5 lbs
Filtration Area	8.4 in <sup>2</sup> / 54.2 cm <sup>2</sup>	8.4 in <sup>2</sup> / 54.2 cm <sup>2</sup>	8.4 in <sup>2</sup> / 54.2 cm <sup>2</sup>
Direction of Flow	Bidirectional	Bidirectional	Bidirectional
Operating Temp Range	-40°F to 302°F / -40°C to 150°C	-40°F to 302°F / -40°C to 150°C	-40°F to 302°F / -40°C to 150°C
Maximum Air Flow Rate	15 SCFM	15 SCFM	15 SCFM

### Air Flow Performance

The curves below show the air flow performance of the E Z Dri breathers. To ensure the longest life possible, the initial clean pressure drop should not exceed 1.0 psid (.07 bar).

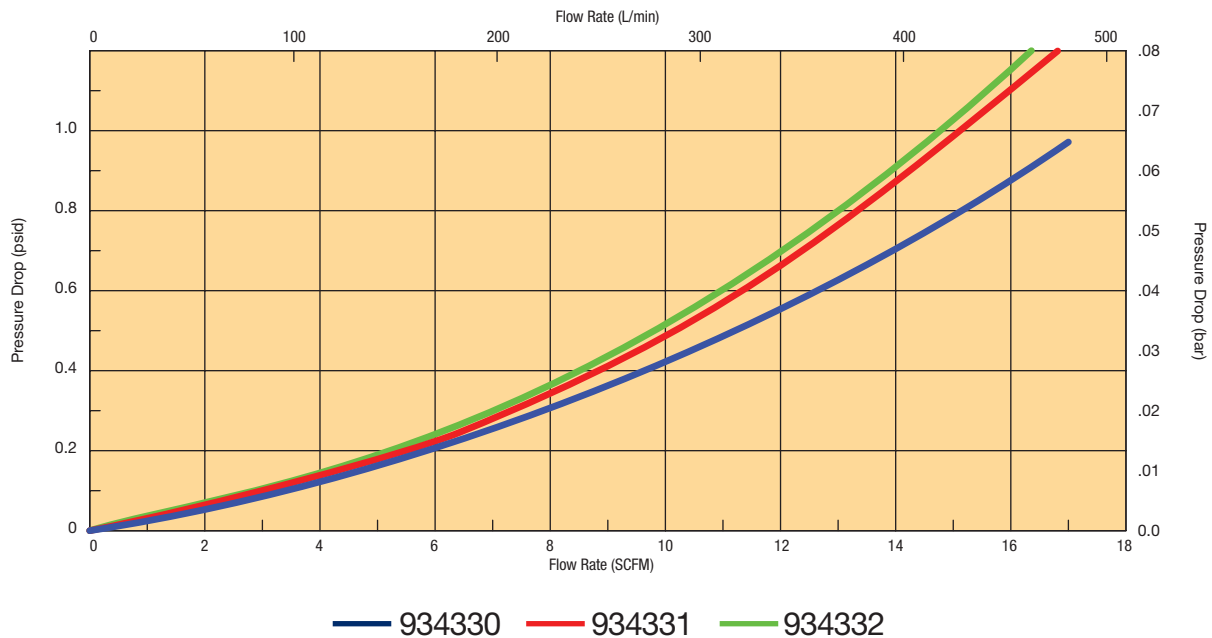

# TriCeptor

## Features

**Materials:**

Housing: Polycarbonate, Nylon 6/6 30% Glass Filled, Polypropylene

**Filter Efficiency:** 3μ absolute ( $\beta_3 \geq 200$ )

**Operating Temperatures:** -20°F (-29°C) to 200°F (93°C)

**Seals:** Nitrile, PVC

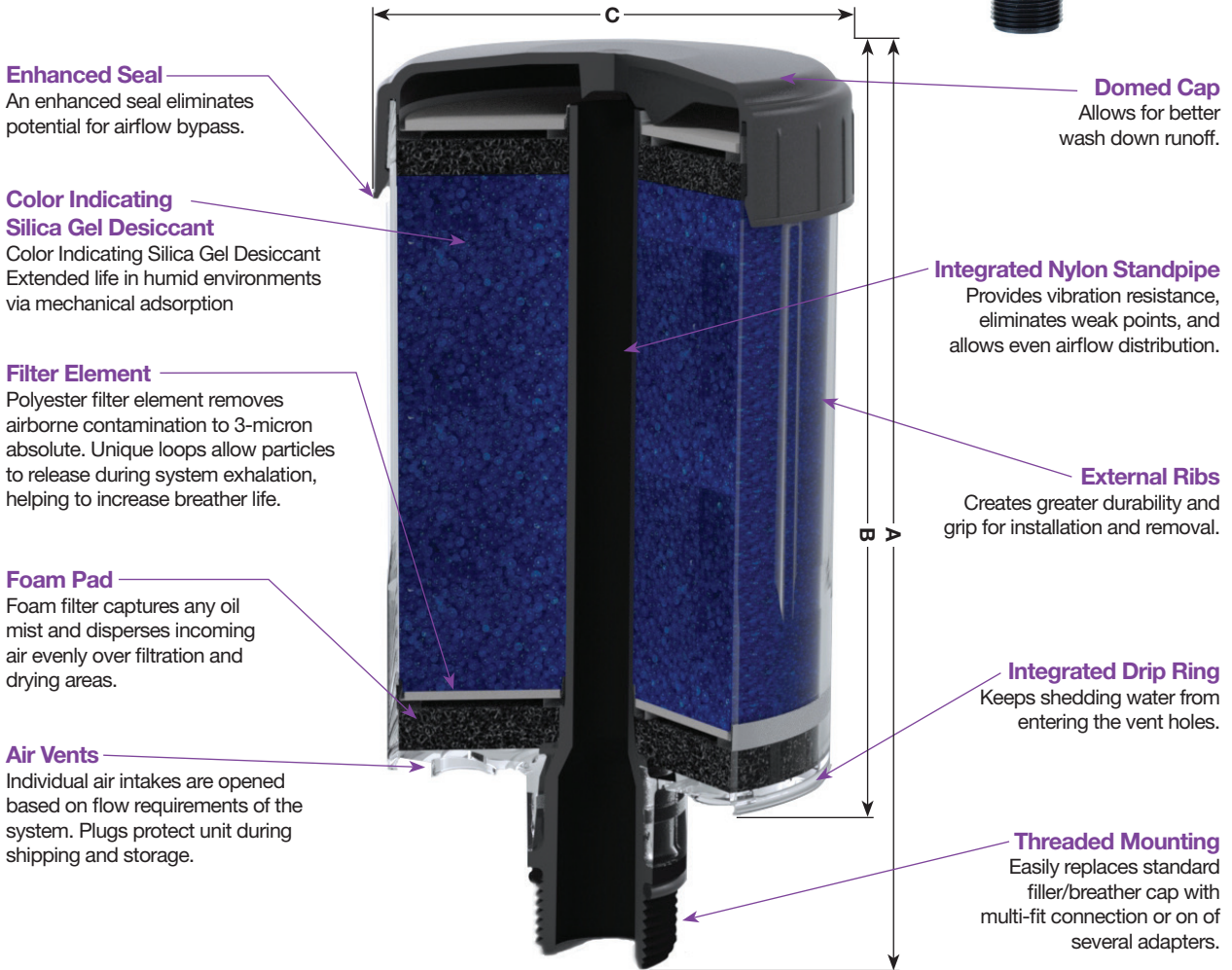
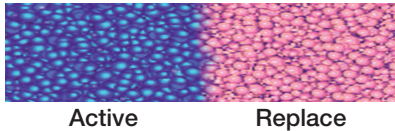

Part Number	A (in/mm)	B (in/mm)	C (in/mm)	Thread	Qty
934330T	6.00/152	5.33/135	4.10/104	1" multi-fit male thread with o-ring seal compatible with 1" NPT; 1" NPSM; 1" BSPT; 1" BSPP	6 pcs
934331T	8.00/203	7.33/186	4.10/104	1" multi-fit male thread with o-ring seal compatible with 1" NPT; 1" NPSM; 1" BSPT; 1" BSPP	6 pcs
934332T	10.00/254	9.33/237	4.10/104	1" multi-fit male thread with o-ring seal compatible with 1" NPT; 1" NPSM; 1" BSPT; 1" BSPP	6 pcs

# TriCeptor

## Specifications

General Data	934330T	934331T	934332T
Amount of Silica Gel	0.8 lbs	1.4 lbs	2.0 lbs
	0.4 kg	0.6 kg	0.9 kg
Adsorption Capacity	4.9 fl oz	8.7 fl oz	12.4 fl oz
	146 ml	257 ml	365 ml
Net Weight of Unit	1.2 lbs	1.9 lbs	2.6 lbs
	0.5 kg	0.9 kg	1.2 kg
Direction of Flow	Bidirectional	Bidirectional	Bidirectional
Operating Temp Range	-20°F to 200°F / -29°C to 93°C	-20°F to 200°F / -29°C to 93°C	-20°F to 200°F / -29°C to 93°C
Maximum Air Flow Rate	16 SCFM	16 SCFM	16 SCFM

### Air Flow Performance

The curves below show the air flow performance of the TriCeptor breathers. To ensure the longest life possible, the initial clean pressure drop should not exceed 1.0 psid (.07 bar).

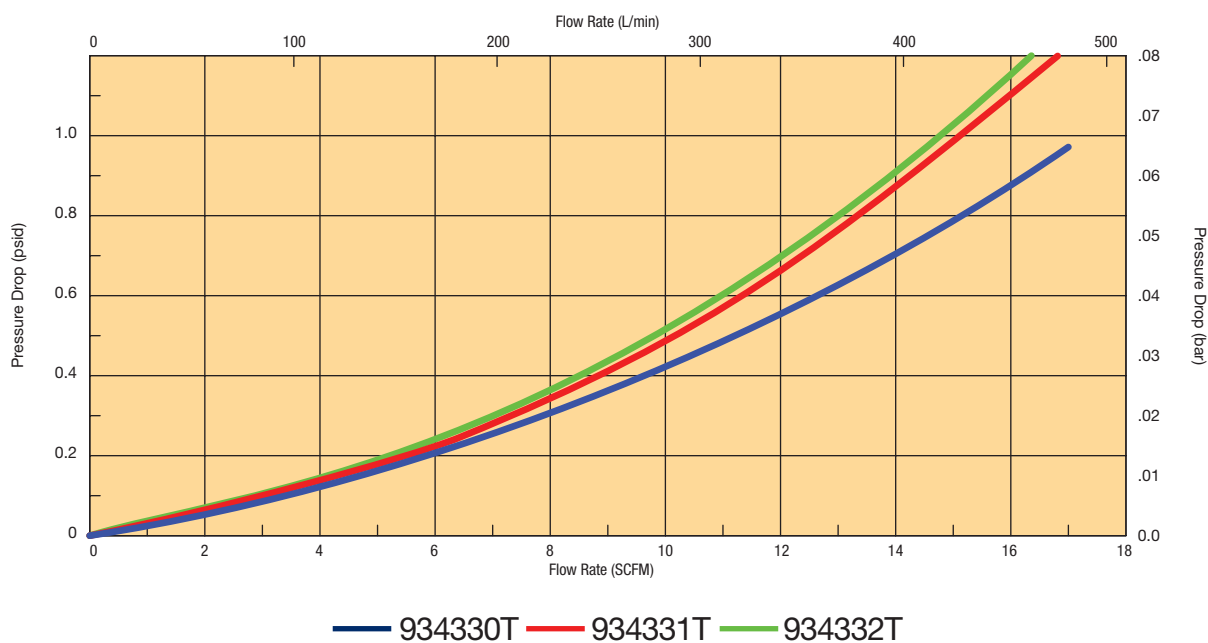

# E Z Dri Mobile

## Features and Specifications

### Materials:

Casing: Polycarbonate/Polybutylene Terephthalate, Aluminum, Polyurethane, Polycarbonate  
 Stand pipe: Polycarbonate tube

**Multi-layer Filtration:** Foam pad filter, 3µ polyester filter, 0.3µ PTFE filter,  
**Operating Temperatures:** -40°F (-40°C) to 300°F (149°C)

**Seals:** None

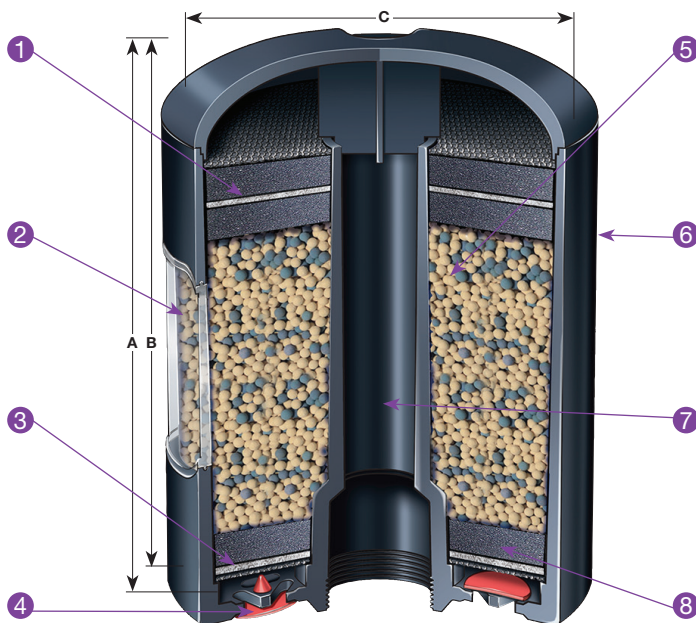

- 1 Filter Element - Second particulate filter element protects against migration of desiccant.
- 2 Visual Indicator - Windows on two sides of breather allow for easy monitoring of desiccant.
- 3 Filter Element - ePTFE filter removes airborne contamination to 0.3 absolute.
- 4 Quad Check Valves - Check-valves provide system pressurization, protecting system integrity and extending product life.

- 5 Water Vapor Adsorbent - Color-indicating zeolite adsorbs water from incoming air.
- 6 Rugged Housing - PC/PBT allow maximizes chemical compatibility at the surface and impact resistance at the core.
- 7 Integrated Standpipe - Resilient construction provides durability and allows oil mist to coalesce and drain back into the reservoir.
- 8 Foam Pad - Foam filter captures any oil mist and disperses incoming air evenly over filtration and drying areas.

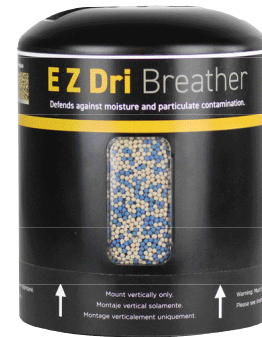

941655

### General Data

Amount of Desiccant	1.59 lbs / 0.72 kg
Adsorption Capacity	6.1 fl oz / 176 ml
Net Weight of Unit	3.2 lbs / 1.5 kg
Direction of Flow	Bidirectional
Operating Temperature Range	-40°F to 300°F/ -40°C to 150°C
Maximum Flow Rate	15 SCFM

### Unit Material Data

Material	Nylon and MXD6
Maximum Operating Temperature	300°F/149°C
Melting Point	320°F/160°C
Check Valve Adapter	Zinc Plated Steel

### Filter Media

Material	EPTFE
Porosity	3.5-7.5 ft/min @ 0.5 in - H <sub>2</sub> O (ASTM D 373)
Filtration Efficiency	Beta 200 @ 0.3µ (IES-RP-CCo21.1)

### General Data

Apparent Bulk Density	700-800 kg/m <sup>3</sup>
Average Particle Diameter	0.145"/3.68 mm
Specific Heat	0.25 BTU/lb F
Nominal Mesh Range	4x8
Average Crush Strength	35 lbs/15.9 kg

Part Number	A (in/mm)	B (in/mm)	C (in/mm)	Thread	Qty*
941655	6.34/158.5	6.17/156.7	5.1/129.5	1 1/2" - 16 UN Female Thread	1 pc

\* Must be ordered in multiples of six (6).



# TriCeptor Mobile

## Features and Specifications

### Materials:

Casing: Polycarbonate/Polybutylene Terephthalate, Aluminum, Polyurethane, Polycarbonate  
 Stand pipe: Polycarbonate tube

**Multi-layer Filtration:** Foam pad filter, 3 $\mu$  polyester filter, 0.3 $\mu$  PTFE filter,

**Operating Temperatures:** -40°F (-40°C) to 300°F (149°C)

**Seals:** None

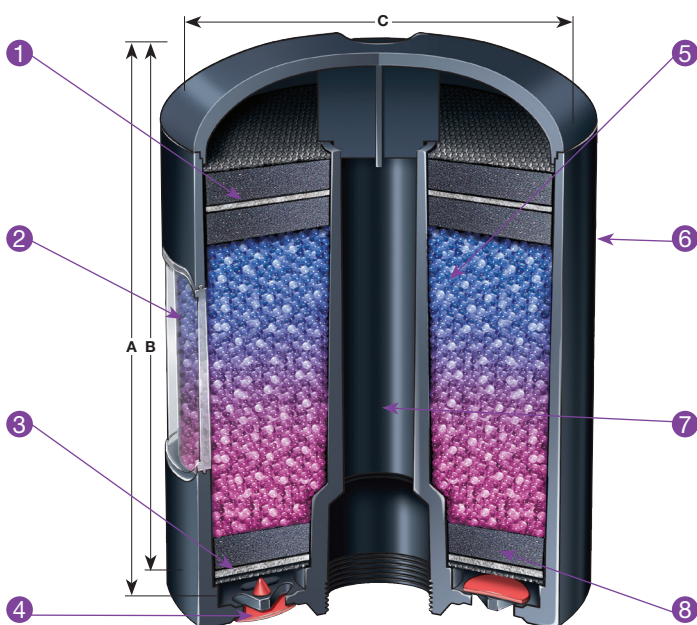

**1 Filter Element** - Second particulate filter element protects against migration of desiccant.

**2 Visual Indicator** - Windows on two sides of breather allow for easy monitoring of desiccant.

**3 Filter Element** - ePTFE filter removes airborne contamination to 0.3 absolute.

**4 Quad Check Valves** - Check-valves provide system pressurization, protecting system integrity and extending product life.

**5 Water Vapor Adsorbent** - Color-indicating silica gel adsorbs water from incoming air.

**6 Rugged Housing** - PC/PBT allow maximizes chemical compatibility at the surface and impact resistance at the core.

**7 Integrated Standpipe** - Resilient construction provides durability and allows oil mist to coalesce and drain back into the reservoir.

**8 Foam Pad** - Foam filter captures any oil mist and disperses incoming air evenly over filtration and drying areas.



**941655T**

### General Data

Amount of Desiccant	1.75 lbs / 0.79 kg
Adsorption Capacity	10.7 fl oz / 315 ml
Net Weight of Unit	3.3 lbs / 1.5 kg
Direction of Flow	Bidirectional
Operating Temperature Range	-40°F to 300°F / -40°C to 150°C
Maximum Flow Rate	16 SCFM

### Unit Material Data

Material	Nylon and MXD6
Maximum Operating Temperature	300°F/148.9°C
Melting Point	320°F/160°C
Check Valve Adapter	Zinc Plated Steel

### Filter Media

Material	EPTFE
Porosity	3.5-7.5 ft/min @ 0.5 in - H <sub>2</sub> O (ASTM D 373)
Filtration Efficiency	Beta 200 @ 0.3 $\mu$ (IES-RP-CC021.1)

### General Data

Apparent Bulk Density	700-800 kg/m <sup>3</sup>
Average Particle Diameter	0.145"/3.68 mm
Specific Heat	0.25 BTU/lb F
Nominal Mesh Range	8x12
Average Crush Strength	35 lbs/15.9 kg

Part Number	A (in/mm)	B (in/mm)	C (in/mm)	Thread	Qty*
941655T	6.34/158.5	6.17/156.7	5.1/129.5	1 1/2" - 16 UN Female Thread	1 pc

\* Must be ordered in multiples of six (6).

# TriCeptor Plus

## Features

**Materials:**

Housing: Polycarbonate, Nylon 6/6 30% Glass Filled, Polypropylene

**Filter Efficiency:** 3μ absolute ( $\beta_3 \geq 200$ )

**Operating Temperatures:** -20°F (-29°C) to 200°F (93°C)

**Seals:** Nitrile, PVC

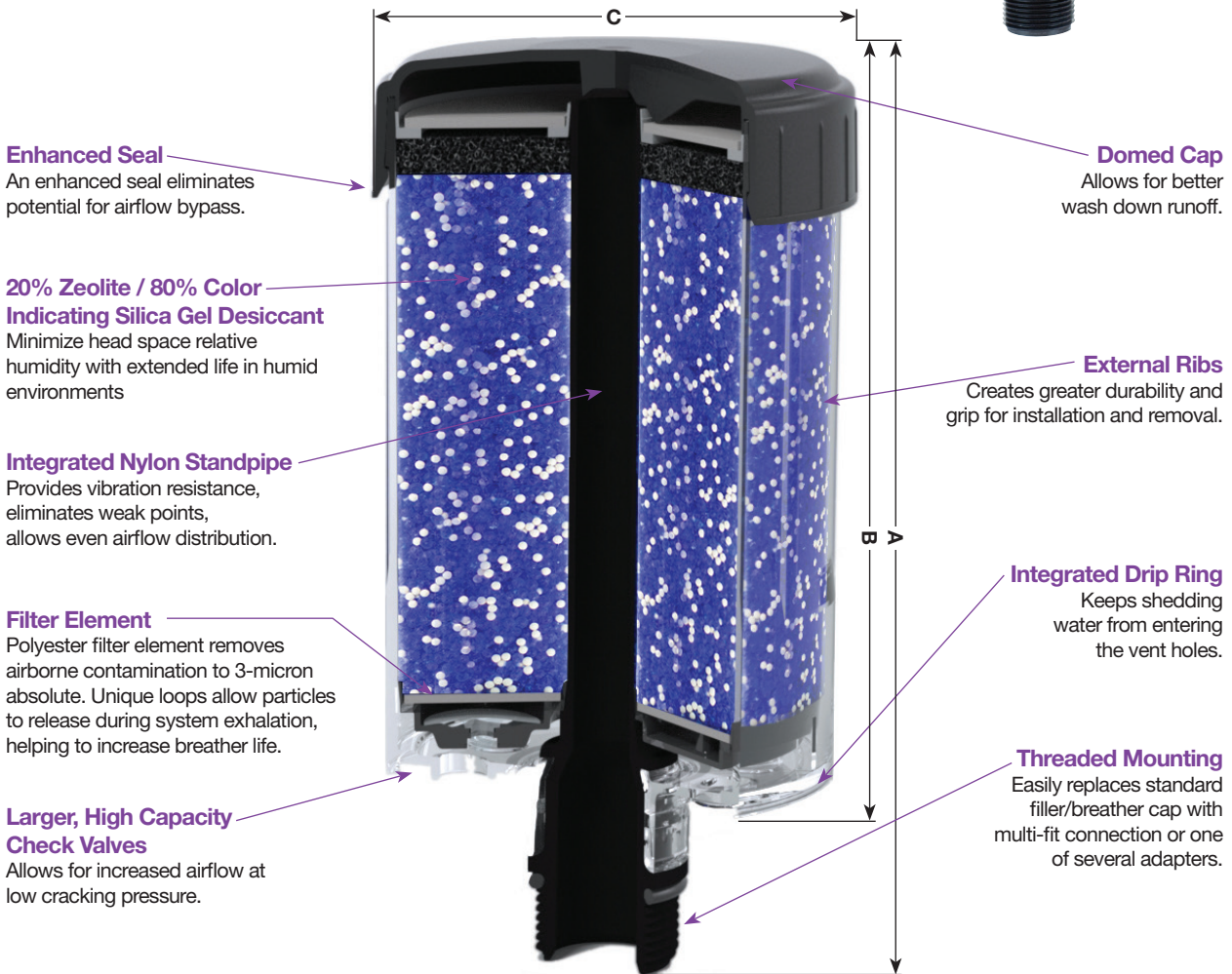
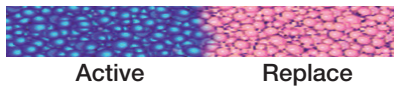

Part Number	A (in/mm)	B (in/mm)	C (in/mm)	Thread	Qty
947333	6.00/152	5.33/135	4.10/104	1" multi-fit male thread with o-ring seal compatible with 1" NPT; 1" NPSM; 1" BSPT; 1" BSPP	6 pcs
947334	8.00/203	7.33/186	4.10/104	1" multi-fit male thread with o-ring seal compatible with 1" NPT; 1" NPSM; 1" BSPT; 1" BSPP	6 pcs
947335	10.00/254	9.33/237	4.10/104	1" multi-fit male thread with o-ring seal compatible with 1" NPT; 1" NPSM; 1" BSPT; 1" BSPP	6 pcs

# TriCeptor *Plus*

## Specifications

General Data	947333	947334	947335
Amount of ZEOLITE	0.16 lbs	0.28 lbs	0.40 lbs
	0.07 kg	0.13 kg	0.18 kg
Amount of Silica Gel	0.64 lbs	1.12 lbs	1.60 lbs
	0.29 kg	0.51 kg	0.73 kg
Adsorption Capacity	4.7 fl oz	8.3 fl oz	11.8 fl oz
	139 ml	246 ml	349 ml
Net Weight of Unit	1.2 lbs	1.9 lbs	2.6 lbs
	0.54 kg	0.86 kg	1.18 kg
Direction of Flow	Bidirectional	Bidirectional	Bidirectional
Operating Temp Range	-20°F to 200°F / -29°C to 93°C	-20°F to 200°F / -29°C to 93°C	-20°F to 200°F / -29°C to 93°C
Maximum Flow Rate	12 SCFM	11 SCFM	10 SCFM

### Air Flow Performance

The curves below show the air flow performance of the TriCeptor *Plus* breathers. To ensure the longest life possible, the initial clean pressure drop should not exceed 1.0 psid (.07 bar).

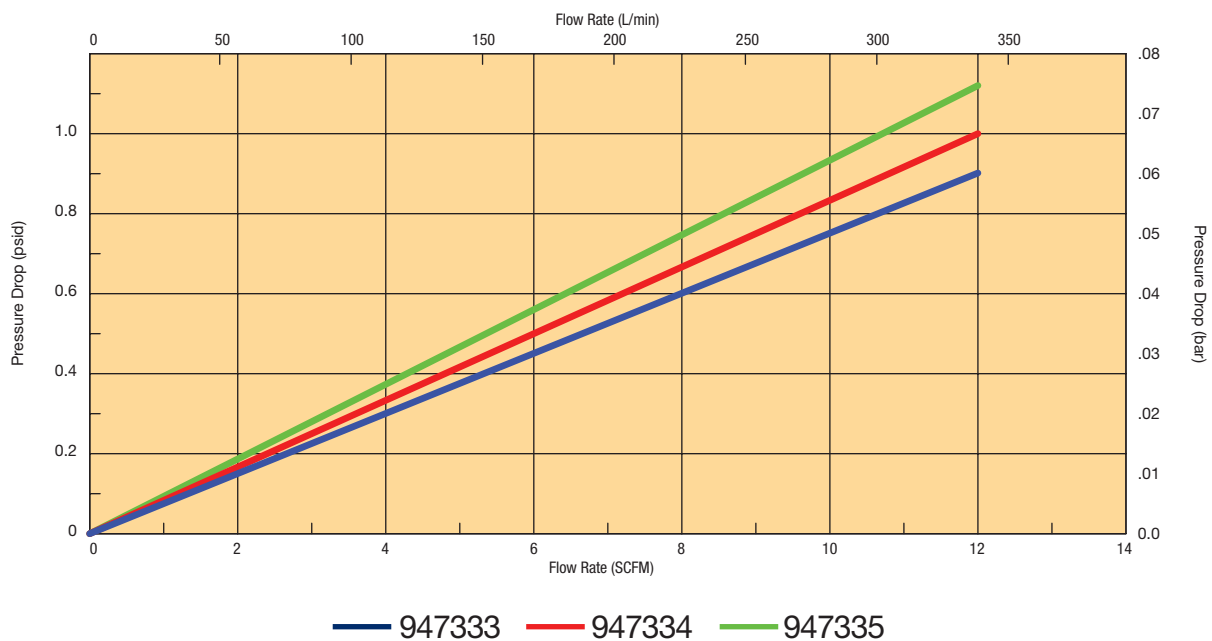

# TriCeptor *Extended*

## Features

### Materials:

Housing: Polycarbonate, Nylon 6/6 30% Glass Filled, Polypropylene

**Filter Efficiency:** 3 $\mu$  absolute ( $\beta_3 \geq 200$ )

**Operating Temperatures:** -20°F (-29°C) to 200°F (93°C)

**Seals:** Nitrile, PVC



Part Number	A (in/mm)	B (in/mm)	C (in/mm)	Thread	Qty
947336	6.40/163	6.02/153.34	5.66/143.88	1" Female (FNPT)	6 pcs
947337	8.20/208	7.82/198.34	5.66/143.88	1" Female (FNPT)	6 pcs
947338	10.00/254	9.62/244.34	5.66/143.88	1" Female (FNPT)	6 pcs

# TriCeptor *Extended*

## Specifications

General Data	947336	947337	947338
Amount of ZEOLITE	0.42 lbs	0.64 lbs	0.84 lbs
	0.19 kg	0.29 kg	0.38 kg
Amount of Silica Gel	1.68 lbs	2.56 lbs	3.35 lbs
	0.76 kg	1.16 kg	1.52 kg
Adsorption Capacity	12.8 fl oz	18.9 fl oz	25.0 fl oz
	379 ml	558 ml	738 ml
Net Weight of Unit	3.5 lbs	4.8 lbs	5.9 lbs
	1.59 kg	2.18 kg	2.68 kg
Direction of Flow	Bidirectional	Bidirectional	Bidirectional
Operating Temp Range	-20°F to 200°F / -29°C to 93°C	-20°F to 200°F / -29°C to 93°C	-20°F to 200°F / -29°C to 93°C
Maximum Flow Rate	26 SCFM	25 SCFM	24 SCFM

### Air Flow Performance

The curves below show the air flow performance of the TriCeptor *Extended* breathers. To ensure the longest life possible, the initial clean pressure drop should not exceed 1.0 psid (.07 bar).

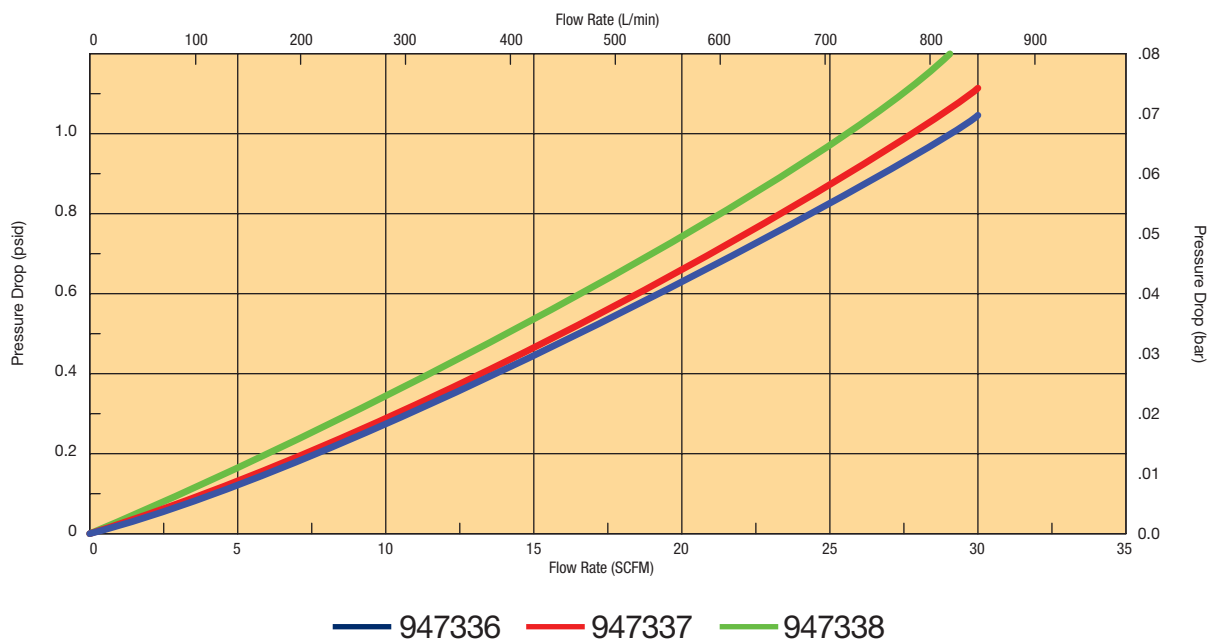

# ClearConnect

## Features

### Materials:

Housing: Polycarbonate, Nylon 6/6 30% Glass Filled, Polypropylene

Filter Media: Polyurethane, polyester

**Filter Efficiency:** 3 $\mu$  absolute ( $\beta_3 \geq 200$ )

**Operating Temperatures:** -20°F (-29°C) to 158°F (70°C)

**Seals:** Nitrile, PVC

### Net Weight of Units:

947339 - 2.7 lbs (1.22 kg) CCS10SGBM8M1 - 2.8 lbs (1.27 kg)

947340 - 5.9 lbs (2.68 kg) CCE10SGBM8F1 - 6.0 lbs (2.72 kg)

### Relative Humidity Sensor



### Enhanced Seal<sup>1</sup>

An enhanced seal eliminates potential for airflow bypass.

### External Ribs<sup>1</sup>

Creates greater durability and grip for installation and removal.

### Honeycomb Technology Oil Mist Reducer

Situated inside the standpipe, made from polypropylene for max chemical compatibility. Allows oil mist to coalesce and drain back in to the reservoir rather than compromise the desiccant. (Only in CCE10SGBM8F1).

### Larger, High Capacity Check Valves

Allows for increased airflow at low cracking pressure.

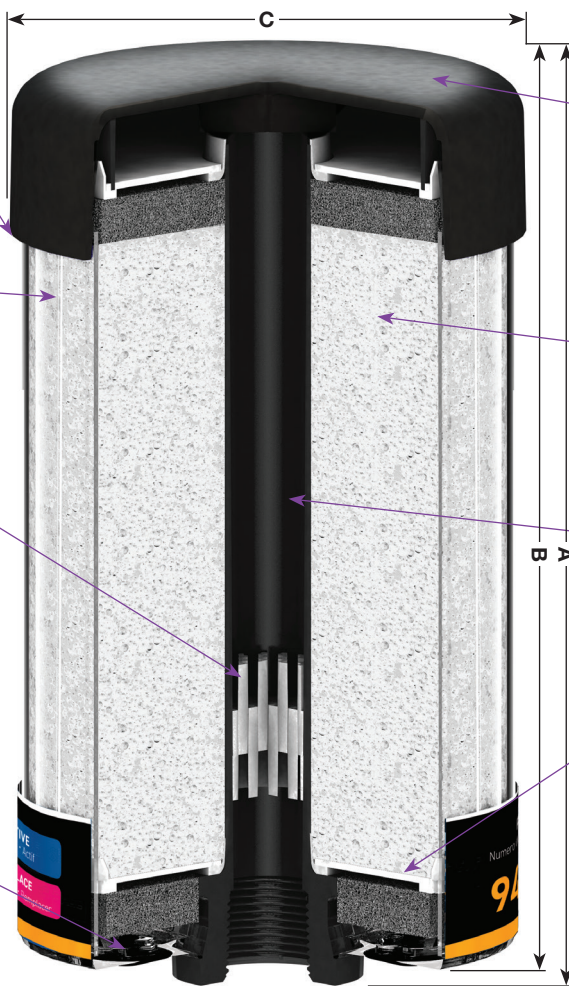

### Domed Cap<sup>1</sup>

Allows for better wash down runoff.

### Clear Silica Gel Desiccant

Up to 20% increase in adsorption capacity compared to color indicating silica gel.

### Integrated Nylon Standpipe

Provides vibration resistance, eliminates weak points, allows even airflow distribution.

### Filter Element

Polyester filter element removes airborne contamination to 3-micron absolute. Unique loops allow particles to release during system exhalation, helping to increase breather life.

### Note:

1 - CCS10SGBM8M1 model only

Breather with Sensor	A (in/mm)	B (in/mm)	C (in/mm)	Thread	Qty
CCS10SGBM8M1	10/253	9.3/237	4.1/104	1" multi-fit male thread with o-ring seal compatible with 1" NPT; 1" NPSM; 1" BSPT; 1" BSPP	1 pcs
CCE10SGBM8F1	10/253	9.6/243	5.7/144	1" Female (FNPT)	1 pcs
<b>Replacement Breather</b>					
947339	10/253	9.3/237	4.1/104	1" multi-fit male thread with o-ring seal compatible with 1" NPT; 1" NPSM; 1" BSPT; 1" BSPP	6 pcs
947340	10/253	9.6/243	5.7/144	1" Female (FNPT)	6 pcs

# ClearConnect

## Specifications



### Materials & Components

Casing	Polycarbonate, Steel (ball plunger)
Cap	Thermoplastic elastomers (TPE), Steel (screws)
Circuit Board	LED lights, FR4 Fiberglass
M8 Connector	Polyamide 67 GF340, Silicone and Nickel Plated Copper Alloy

### Power

Supply Voltage	9-28 V DC
Operational Current Rating	30 mA

Pin 1	Brown	9-28V DC
Pin 2	White	TXA (Low)
Pin 3	Black	TXB (High)
Pin 4	Blue	DC Reference
(Mark State)		

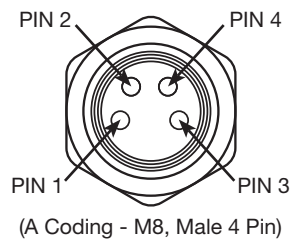

### Environment

13.56 MHz RFID (Module & Sensor-board communication)  
 Intended for indoor and outdoor use  
 Altitude up to 16,404 ft (5,000 m)  
 Maximum Relative Humidity: 100% at up to 158°F (70°C)  
 Dustproof/Waterproof (IP66)  
 Hazardous Ratings: Not rated for hazardous locations  
 FCC, CE, Reach, RoHS

### Connectivity/Data Output

A Coding - M8, 4 pin male  
 RS485 Half Duplex (Modbus)

### Data Storage

Data readings every 60 minutes  
 Stores 365 Half days of hourly data points

### Power/Data Cable

4 position connector with wire leads x 3m connected  
 breather cable assembly (sold separately)

### Air Flow Performance

The curves below show the air flow performance of the ClearConnect breathers. To ensure the longest life possible, the initial clean pressure drop should not exceed 1.0 psid (.07 bar).

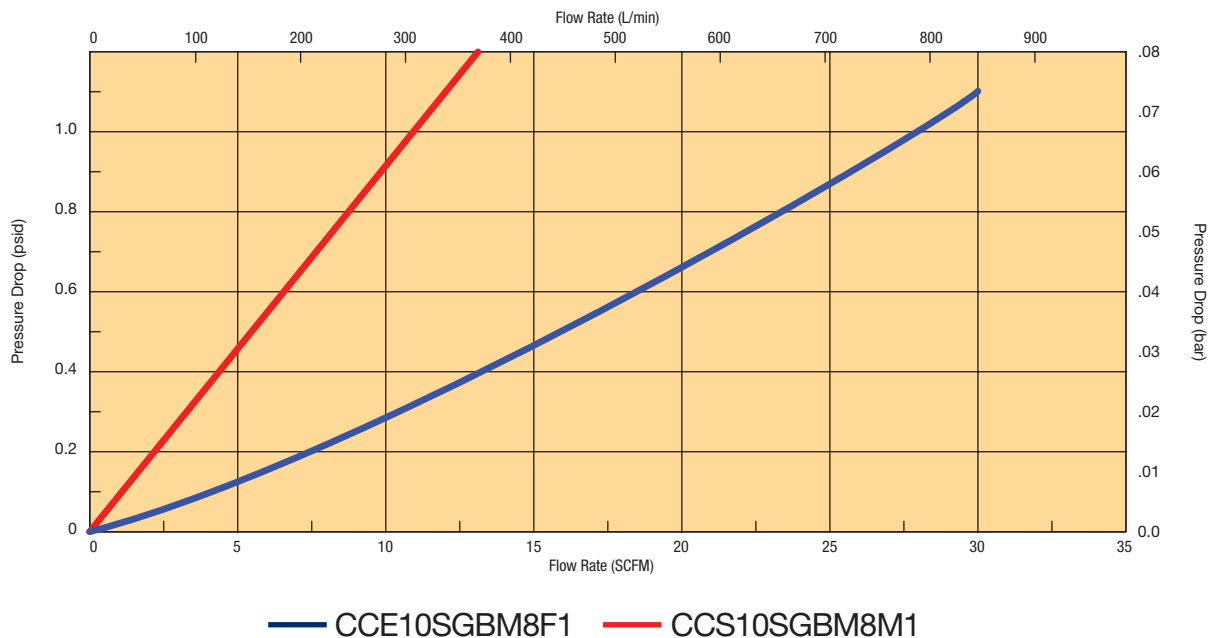

# Desiccant Breathers

## Accessories

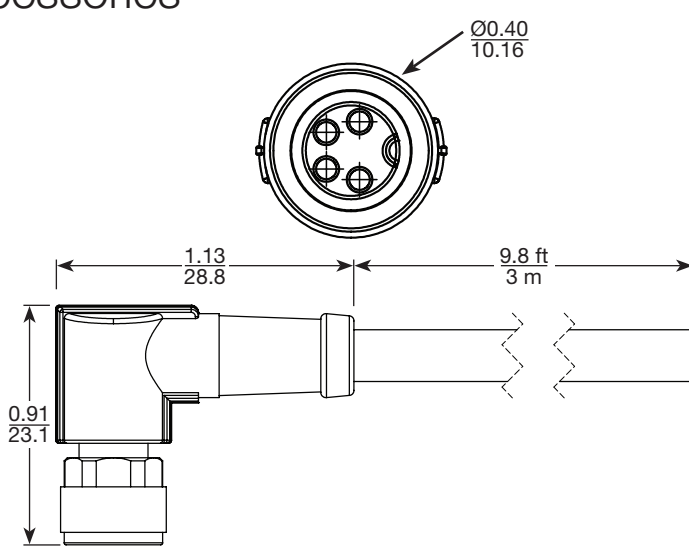

**ClearConnect Power/Data Cable**  
**Length:** 3 Meters  
**Connection:** A Coding - M8, 4 Pin  
**Recommended Torque:** 0.4Nm  
**Temperature Range:** 23°F to 176°F (-5°C to 80°C)

Part Number	Description	Qty
947341	Power/Data Cable	1 pc

For use with ClearConnect

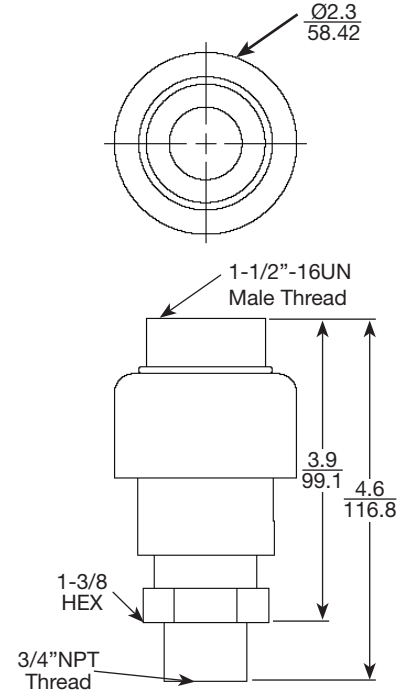

Part Number	Description	Qty
946056	Check Valve Adapter	1 pc

For use with Mobile Breathers

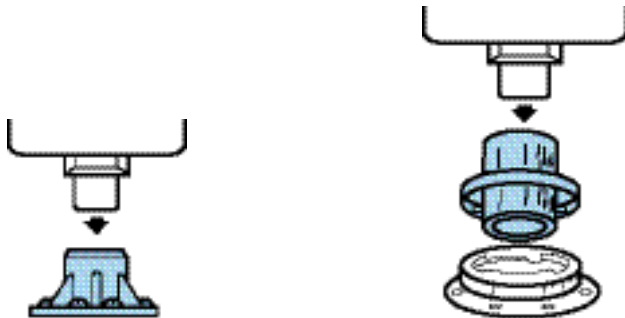

Part Number	Description	Qty
937546	Field Adapter	1 pc

For use with E Z Dri, Triceptor, Triceptor Plus, Triceptor Extended and ClearConnect

Part Number	Description	Qty
937463	Flange Adapter	1 pc

For use with E Z Dri, Triceptor, Triceptor Plus, Triceptor Extended and ClearConnect

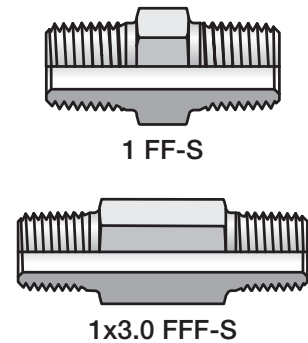

Part Number	Description	Qty
1 FF-S	2.34" Pipe with 1" NPT connections	1 pc
1x3.0 FFF-S	3" Pipe with 1" NPT connections	1 pc

Please contact Parker Tube Fittings Division at [tfd.support@support.com](mailto:tfd.support@support.com) or call 614.279.7070

inches  
mm

Drawings are for reference only.  
Contact factory for current version.



# Desiccant Breathers

## Maintenance

	Installation	Disposal
<b>E Z Dri</b> <i>Zeolite Breather</i>	<ol style="list-style-type: none"> <li>1. Remove safety cap from bottom of standpipe</li> <li>2. Remove caps from bottom vent holes</li> <li>3. Mount breather to the tank or reservoir using the adapter best suited for the application</li> </ol>	<ol style="list-style-type: none"> <li>1. Verify the breather is fully saturated - all blue beads will be beige in color</li> <li>2. Remove breather from gearbox, tank, reservoir, or other application</li> <li>3. Remove and save the adapter fitting to be used with a new breather</li> <li>4. Verify and dispose of breather in accordance with your state and local environmental control regulations</li> </ol>
<b>TriCeptor</b> <i>Silica Gel Breather</i>  <b>TriCeptor Plus</b> <i>Mixed Desiccant Breather</i>	<ol style="list-style-type: none"> <li>1. Remove safety cap from bottom of standpipe</li> <li>2. Remove caps from bottom vent holes</li> <li>3. Mount breather to the tank or reservoir using the adapter best suited for the application</li> </ol>	<ol style="list-style-type: none"> <li>1. Verify the breather is fully saturated - all blue beads will be pink in color</li> <li>2. Remove breather from gearbox, tank, reservoir, or other application</li> <li>3. Remove and save the adapter fitting to be used with a new breather</li> <li>4. Verify and dispose of breather in accordance with your state and local environmental control regulations</li> </ol>
<b>Mobile</b> <i>Rugged Breather</i>	<ol style="list-style-type: none"> <li>1. Remove safety cap from bottom of standpipe</li> <li>2. Mount breather to the tank or reservoir using the adapter best suited for the application</li> </ol>	<ol style="list-style-type: none"> <li>1. Verify the breather is fully saturated</li> <li>2. Remove breather from gearbox, tank, reservoir, or other application</li> <li>3. Remove and save the adapter fitting to be used with a new breather</li> <li>4. Verify and dispose of breather in accordance with your state and local environmental control regulations</li> </ol>
<b>TriCeptor Extended</b> <i>Mixed Desiccant Breather</i>	<ol style="list-style-type: none"> <li>1. Remove safety cap from bottom of breather</li> <li>2. Mount breather to the tank or reservoir using the adapter best suited for the application</li> </ol>	<ol style="list-style-type: none"> <li>1. Verify the breather is fully saturated - all blue beads will be pink in color</li> <li>2. Remove breather from gearbox, tank, reservoir, or other application</li> <li>3. Remove and save the adapter fitting to be used with a new breather</li> <li>4. Verify and dispose of breather in accordance with your state and local environmental control regulations</li> </ol>
<b>ClearConnect</b> <i>Wired Relative Humidity Sensor</i>	<ol style="list-style-type: none"> <li>1. Remove safety cap from bottom of breather</li> <li>2. Connect sensor communication module using provided wiring digram</li> <li>3. Mount breather to the tank or reservoir using the adapter best suited for the application</li> <li>4. Install wired sensor communication module onto breather body</li> </ol>	<ol style="list-style-type: none"> <li>1. Verify the breather is fully saturated - Change when breather life remaining is 0%.</li> <li>2. Remove sensor communication module from spent breather cartridge - slide toward top cap.</li> <li>3. Remove breather from gearbox, tank, reservoir, or other application</li> <li>4. Remove and save the adapter fitting to be used with a new breather</li> <li>5. Verify and dispose of breather in accordance with your state and local environmental control regulations</li> </ol>





## Hydraulic & Fuel Filtration Division

Your prescription for total system health.

Dedicated to the long term health and reliability of mission critical assets, Parker Hydraulic & Fuel Filtration Division offers you innovative products that cover your diagnostic, therapeutic and preventive needs.



# Total System Health Management



**Diagnostic**  
Monitors  
Detects  
Alerts



**Therapeutic**  
Supports  
Improves  
Fortifies



**Preventive**  
Long Term Defense  
Long Term Value  
Reduced Cost of Ownership



Your Trusted Partner in Total System Health Management



# Parker Filtration Group

## **Aerospace Filtration Division**

Greensboro, North Carolina  
336 668 4444

## **Bioscience & Water Filtration Division**

Bioscience Filtration  
Oxnard, California  
877 784 2234

Water Purification  
Carson, California  
310 608 5600

## **Engine Mobile Aftermarket Division**

Kearney, Nebraska  
308 234 1951

## **Engine Mobile Original Equipment Division**

Modesto, California  
209 521 7860

## **HVAC Filtration Division**

Jeffersonville, Indiana  
866 247 4827

## **Hydraulic & Fuel Filtration Division**

Metamora, Ohio  
419 644 4311

## **Industrial Gas Filtration & Generation Division**

Lancaster, NY  
800 343 4048

## **Industrial Process Filtration Division**

Mineral Wells, Texas  
940 325 2575

## **Bioscience Engineering Filtration Division EMEA**

Birtley, United Kingdom  
+44 (0) 191 410 5121

## **Engine Mobile Filtration Division EMEA**

Dewsbury, United Kingdom  
+44 (0) 1924 487 037

## **Gas Separation & Filtration Division EMEA**

Team Valley, United Kingdom  
+44 (0) 191 402 9000

## **Gas Turbine Filtration Division**

Alton, United Kingdom  
+44 (0) 1420 541188

## **Hydraulic & Industrial Filtration Division EMEA**

Arnhem, Netherlands  
+31 (0) 26 376 0376

## **Australia Filtration Division**

Castle Hill, Australia  
+61 2 9634 7777

## **China Filtration Division**

Shanghai, China  
+86 21 2067 2067

## **India Filtration Division**

Chennai, India  
+91 22 4391 0700

## **Korea Filtration Division**

Hwaseon City, Korea  
+82 31 359 0852

## **Latin America Filtration Division**

Sao Paulo, Brazil  
+55 12 4009 3500

