

TINA3-W

~40° wide beam. Assembly with holder and installation tape.

TECHNICAL SPECIFICATIONS:

Dimensions	Ø 16.1 mm
Height	6.9 mm
Fastening	tape, pin
Colour	white
Box size	451 x 241 x 298 mm
Box weight	8.5 kg
Quantity in Box	5750 pcs
ROHS compliant	yes ⓘ



MATERIAL SPECIFICATIONS:

Component	Type	Material	Colour
TINA3-W	Single lens	PMMA	clear
TINA3-HLD-PIN-TAPE	Holder	PC	white
TINA-TAPE3	Tape	PU tape	

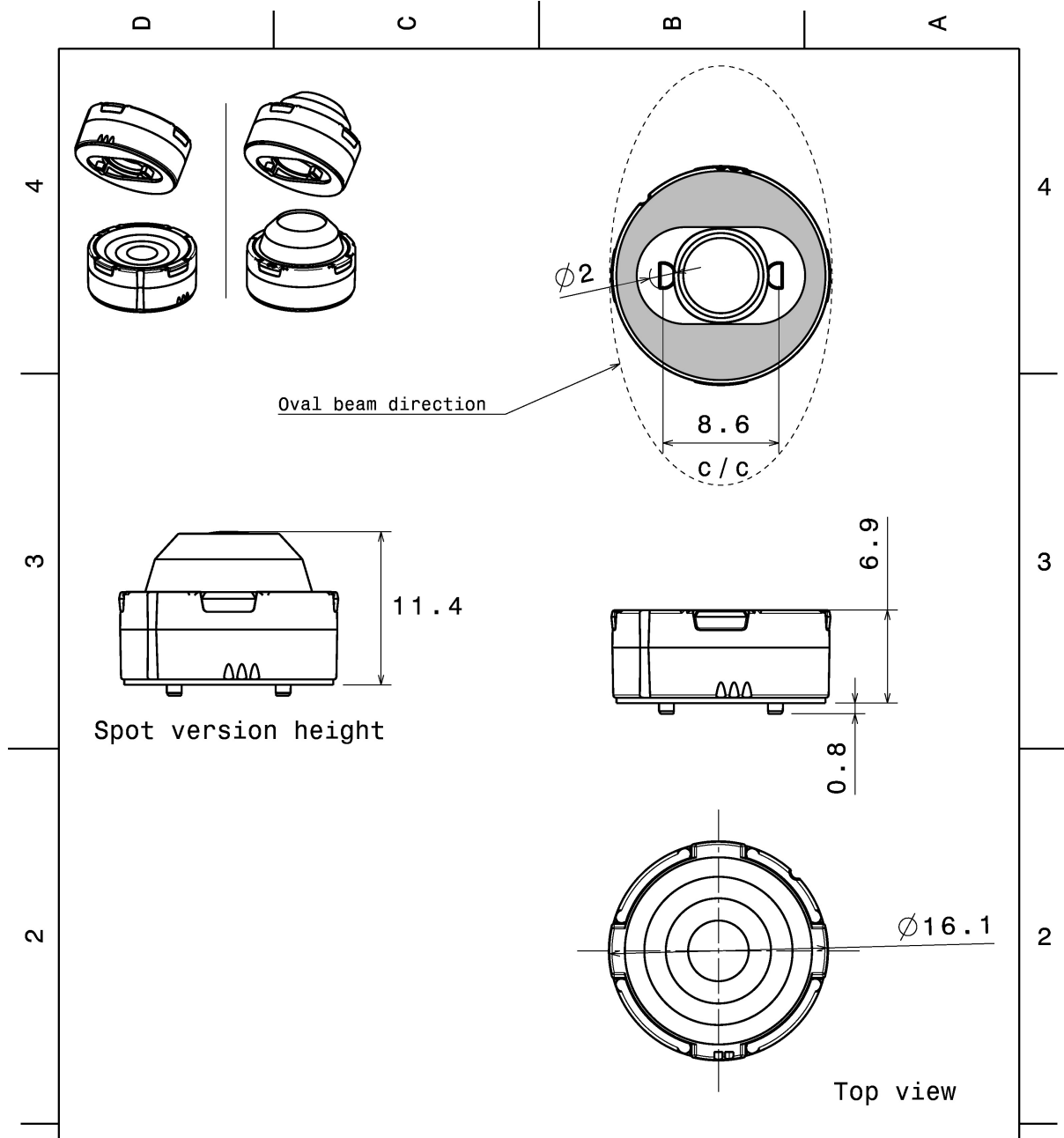

Tolerances if not otherwise shown According to DIN ISO 2768-1 Linear measures: Up to 30mm class M, otherwise class C. According to DIN ISO 2768-2 Form and position: class L		LEDiL LediL Oy Salorankatu 10 FIN 24240 SALO Finland	
THIRD ANGLE PROJECTION:		DRAWING TITLE TINA3 Datasheet	
This drawing is the property of LEDiL Oy. It may not be reproduced, copied or communicated without a written agreement with LEDiL Oy.		SIZE A4	PART NUMBER -
SCALE 4:3		WEIGHT -	SHEET 1/1

PHOTOMETRIC DATA (MEASURED):



LED XHP35 HI
 FWHM 46.0°
 Efficiency 93 %
 Peak intensity 1.500 cd/lm
 LEDs/each optic 1
 Light colour White
 Required components:

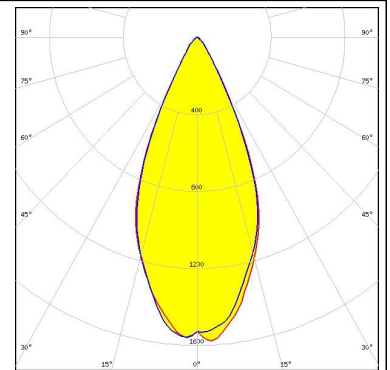
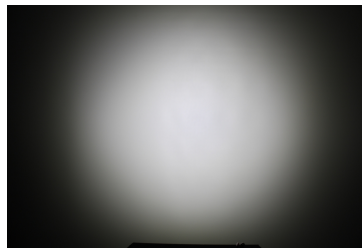

LED XP-E2
 FWHM 43.0°
 Efficiency 90 %
 Peak intensity 1.800 cd/lm
 LEDs/each optic 1
 Light colour White
 Required components:

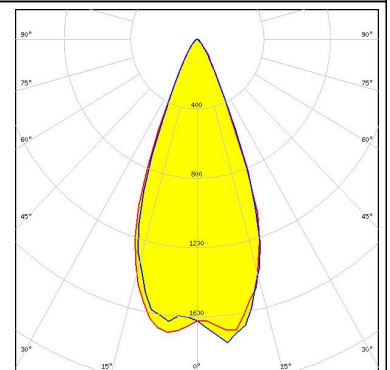
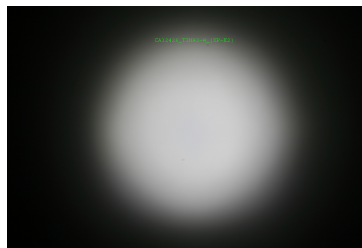

LED XP-G
 FWHM 42.0°
 Efficiency 90 %
 Peak intensity 1.700 cd/lm
 LEDs/each optic 1
 Light colour White
 Required components:

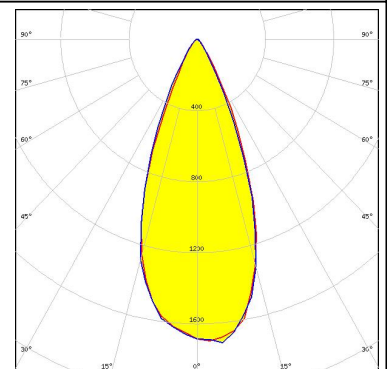

LED XP-G2
 FWHM 42.0°
 Efficiency 91 %
 Peak intensity 1.600 cd/lm
 LEDs/each optic 1
 Light colour White
 Required components:

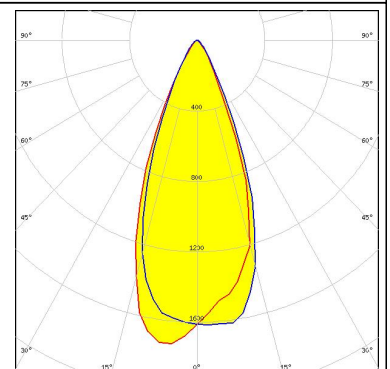

PHOTOMETRIC DATA (MEASURED):



LED XP-L HI
 FWHM 43.0°
 Efficiency 93 %
 Peak intensity 1.600 cd/lm
 LEDs/each optic 1
 Light colour White
 Required components:

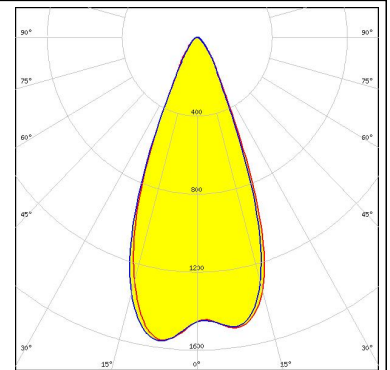

LED XT-E
 FWHM 41.0°
 Efficiency 88 %
 Peak intensity 1.800 cd/lm
 LEDs/each optic 1
 Light colour White
 Required components:

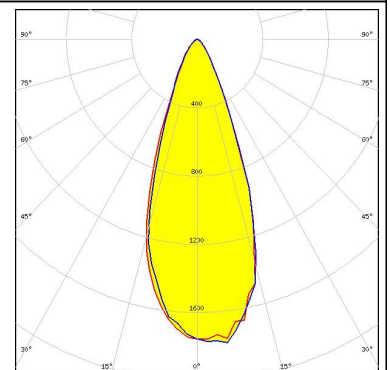

LED LUXEON A
 FWHM 43.0°
 Efficiency 89 %
 Peak intensity 1.500 cd/lm
 LEDs/each optic 1
 Light colour White
 Required components:

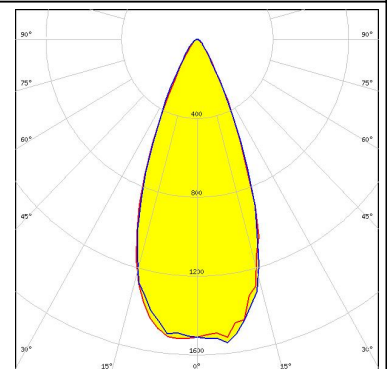

LED LUXEON T
 FWHM 45.0°
 Efficiency 89 %
 Peak intensity 1.500 cd/lm
 LEDs/each optic 1
 Light colour White
 Required components:

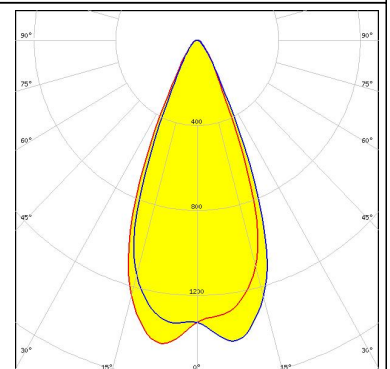
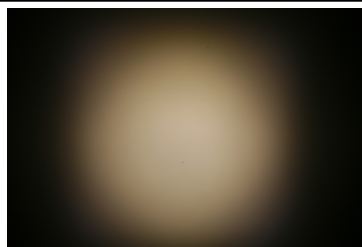

PHOTOMETRIC DATA (MEASURED):



LED LUXEON TX
 FWHM 47.0°
 Efficiency 89 %
 Peak intensity 1.200 cd/lm
 LEDs/each optic 1
 Light colour White
 Required components:

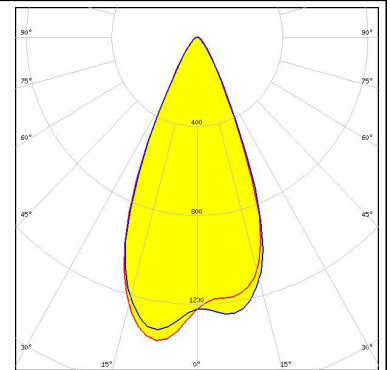
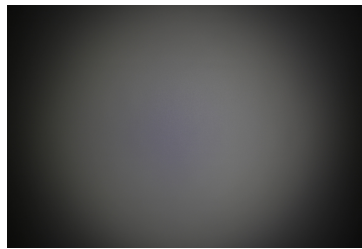

LED NVSxx19A
 FWHM 43.0°
 Efficiency 86 %
 Peak intensity 1.500 cd/lm
 LEDs/each optic 1
 Light colour White
 Required components:

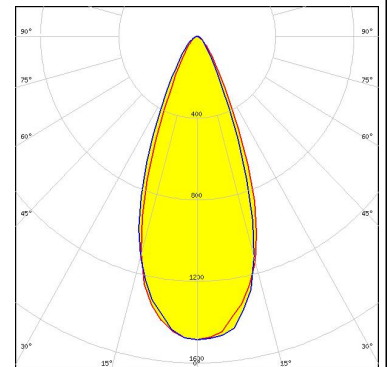

LED NVSxx19B/NVSxx19C
 FWHM 46.0°
 Efficiency 92 %
 Peak intensity 1.400 cd/lm
 LEDs/each optic 1
 Light colour White
 Required components:

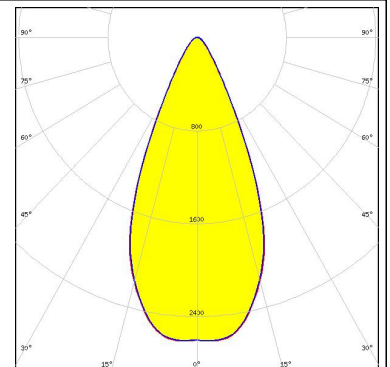
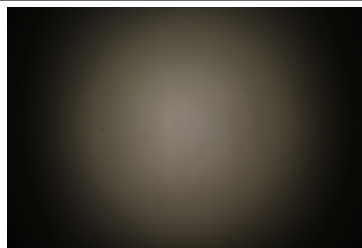

LED OSOLON Square EC
 FWHM 41.0°
 Efficiency 88 %
 Peak intensity 1.700 cd/lm
 LEDs/each optic 1
 Light colour White
 Required components:

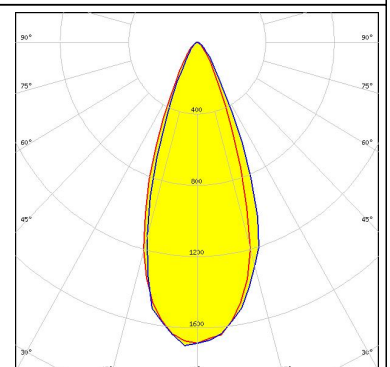

PHOTOMETRIC DATA (MEASURED):

SAMSUNG

LED LH351B
FWHM 46.0°
Efficiency 89 %
Peak intensity 1.400 cd/lm
LEDs/each optic 1
Light colour White
Required components:

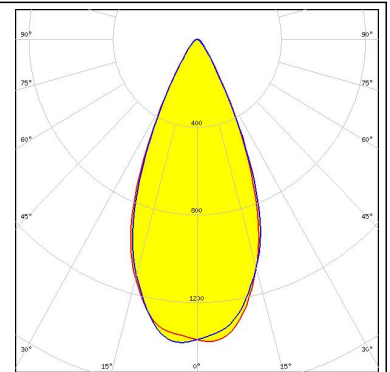

SAMSUNG

LED LH351Z
FWHM 49.0°
Efficiency 89 %
Peak intensity 1.300 cd/lm
LEDs/each optic 1
Light colour White
Required components:

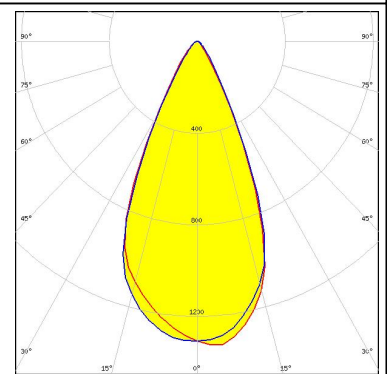
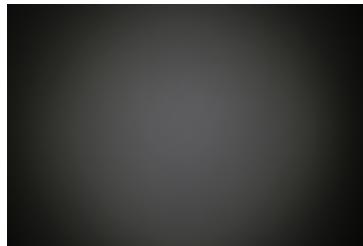

PHOTOMETRIC DATA (SIMULATED):

LUMILEDS

LED LUXEON 2835 Line
FWHM 39.0°
Efficiency 94 %
Peak intensity 1.742 cd/lm
LEDs/each optic 1
Light colour White
Required components:

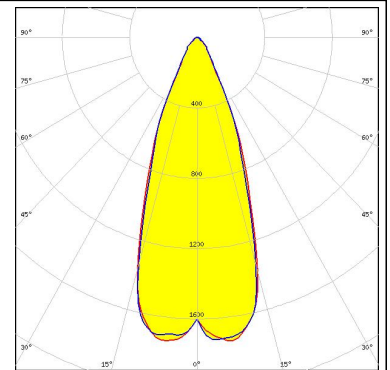

LUMILEDS

LED LUXEON H50-2
FWHM 48.0°
Efficiency 89 %
Peak intensity 1.500 cd/lm
LEDs/each optic 1
Light colour White
Required components:

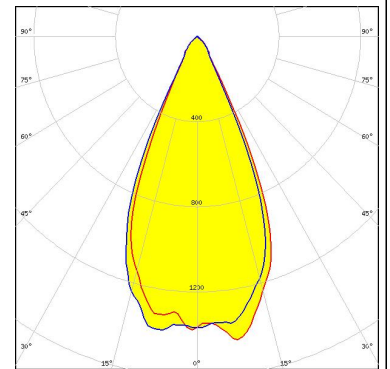

OSRAM

Opto Semiconductors

LED OSLON Square CSSRM2/CSSRM3
FWHM 43.0°
Efficiency 94 %
Peak intensity 1.680 cd/lm
LEDs/each optic 1
Light colour White
Required components:

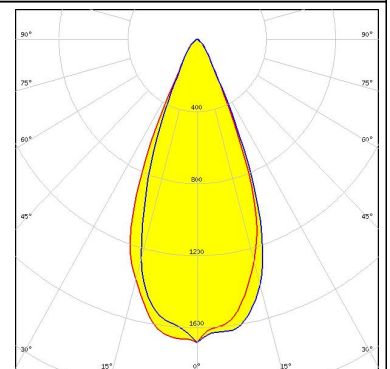

GENERAL INFORMATION:

NOTE: The typical beam angle will be changed by different color, chip size and chip position tolerance. The typical total beam angle is the full angle measured where the luminous intensity is half of the peak value.

MATERIALS:

As part of our continuous research and improvement processes, and to ensure the best possible quality and availability of our products, LEDiL reserves the right to change material grades without notice.

PRODUCT DATA USER AGREEMENT AND DISCLAIMER:

The measured data in the provided downloadable LEDiL Product Datasheets and Mechanical 2D-Drawings is rounded and provided as reference for planning. LEDiL Oy's optical specifications have been verified by conducting performance testing of the products in accordance with the company's quality system. The reported data are averaged results of multiple measurements with typical variation. LEDiL Oy reserves the right to without prior notification make changes and improvements to its products.

LEDiL Oy assumes neither warranty, nor guarantee nor any other liability of any kind for the contents and correctness of the provided data. The provided data has been generated with highest diligence but the provided data may in reality not represent the complete possible variation range of all intrinsic parameters. Therefore, in certain cases a deviation from the provided data could occur.

LEDiL Oy reserves the right to undertake technical changes of its products without further notification which could lead to changes in the provided data. LEDiL Oy assumes no liability of any kind for the possible deviation from any provided data or any other damage resulting from the usage of the provided data.

The user agrees to this disclaimer and user agreement with the download or usage of the provided files.

LEDiL Oy

Joensuunkatu 13
FI-24240 SALO
Finland

LEDiL Inc.

228 West Page Street
Suite D
Sycamore IL 60178
USA

Local sales and technical support

[www.ledil.com/
where_to_buy](http://www.ledil.com/where_to_buy)

Shipping locations

Salo, Finland
Hong Kong, China

Distribution Partners

[www.ledil.com/
where_to_buy](http://www.ledil.com/where_to_buy)