

Product Overview

The QPL7420 is a GaAs pHEMT single ended RF amplifier IC featuring 20 dB of flat gain and low noise. This IC is designed for applications in the Upstream from 5 MHz to 684 MHz and in the Downstream from 47 MHz to 1800 MHz using a single 5 V supply, and it can be used from 3V to 8V depending on linearity requirements. QPL7420 offers low noise and distortion plus high gain in a 3 x 3 QFN package for convenient layout and design in set top and infrastructure projects for 75Ω CATV and satellite applications.

Functional Block Diagram

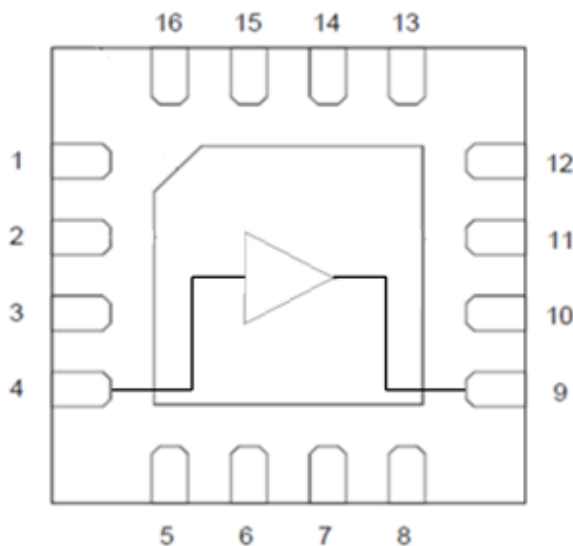

Top View

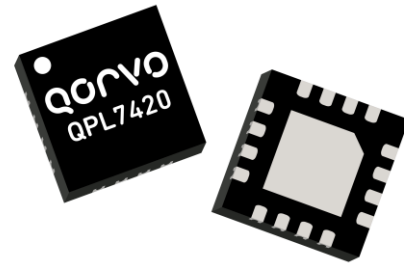

3 x 3 QFN Package

Key Features

- 5 MHz to 1800 MHz Operation
- 3 V, 5 V, and 8 V Operation
- Gain; 20 dB Typical
- Noise Figure; 1.1 dB Typical at 850 MHz
- Adjustable Bias Using External Resistors
- Convenient QFN Package
- RoHS Compliant

Applications

- DOCSIS 3.1
- Downstream Applications, 47 to 1800 MHz
- Upstream Applications, 5 to 684MHz
- Head End CMTS Equipment
- Optical Node
- FTTH GPON and GEAPON
- Satellite Low Noise Amplifier
- Cable Modem and Set Top Box
- Single Ended Gain Block

Ordering Information

Part Number	Description
QPL7420SB	Sample bag with 5 pieces
QPL7420SR	7" Reel with 100 pieces
QPL7420TR7	7" Reel with 2500 pieces
QPL7420EVB01	47 – 1800 MHz Evaluation Board

Absolute Maximum Ratings

Parameter	Rating
Supply Voltage (V_{DD})	+10 V
Supply Current (I_{DD})	140 mA
Maximum Input Level	65 dBmV
Operating Temperature Range (Bottom of case)	-40 to +100 °C
Storage Temperature Range	-65 to +150 °C
Maximum Junction Temperature	+150 °C

Exceeding any one or a combination of the Absolute Maximum Rating conditions may cause permanent damage to the device. Extended application of Absolute Maximum Rating conditions to the device may reduce device reliability.

Electrical Specifications, 47MHz to 1800MHz (5 V)

Parameter	Condition ⁽¹⁾	Min	Typ	Max	Unit
Supply Voltage (V_{DD})			5		V
Supply Current (I_{DD})			63		mA
Frequency Range		47		1800	MHz
Gain			20.6		dB
Gain Slope	47 -1200MHz		0.2		dB
	108 – 1800MHz		0.4		
Reverse Isolation			-23		dB
Input Return Loss			22		dB
Output Return Loss			19		dB
Noise Figure			1.2		dB
MER vs Output Power	45dB MER, 54MHz to 1218MHz, 0dB tilt, 190ch 256QAM ITU-T J.83, Annex B		51.7		dBmV TCP
OIP2L	47-1200MHz		46.5		dBm
	108 – 1800MHz		44.7		
OIP2H	47-1200MHz		39.0		dBm
	108 – 1800MHz		39.0		
OIP3	47-1200MHz		36.7		dBm
	108 – 1800MHz		33.7		
OP1dB	47-1200MHz		20.6		dBm
	108 – 1800MHz		18.6		
Thermal Resistance	Θ_{JC} (Bottom of Case)		27		°C/W

Notes:

1. Typical performance at these conditions: Temp = +25 °C, V_{DD} = +5V, 75 Ω system, Full band unless otherwise noted
2. OIP3; +9dBm/ tone output, 6MHz spacing
3. OIP2; +9dBm/tone output, 50MHz spacing

Electrical Specifications, 47MHz to 1800MHz (8 V)

Parameter	Condition ⁽¹⁾	Min	Typ	Max	Unit
Supply Voltage (V _{DD})			8		V
Supply Current (I _{DD})			102		mA
Frequency Range		47		1800	MHz
Gain			20.8		dB
Gain Slope	47 -1200MHz		0.2		dB
	108 – 1800MHz		0.3		
Reverse Isolation			-23.2		dB
Input Return Loss			22		dB
Output Return Loss			17.5		dB
Noise Figure			1.2		dB
MER vs Output Power	45dB MER, 54MHz to 1218MHz, 0dB tilt, 190ch 256QAM ITU-T J.83, Annex B		54.7		dBmV TCP
OIP2L	47-1200MHz		54.3		dBm
	108 – 1800MHz		52.5		
OIP2H	47-1200MHz		42.9		dBm
	108 – 1800MHz		42.9		
OIP3	47-1200MHz		42.1		dBm
	108 – 1800MHz		42.1		
OP1dB	47-1200MHz		24.3		dBm
	108 – 1800MHz		22.8		
Thermal Resistance	Θ _{JC} (Bottom of Case)		27		°C/W

Notes:

1. Typical performance at these conditions: Temp = +25 °C, V_{DD} = +8V, 75 Ω system, Full band unless otherwise noted

Evaluation Board Schematic, 47 MHz – 1800 MHz

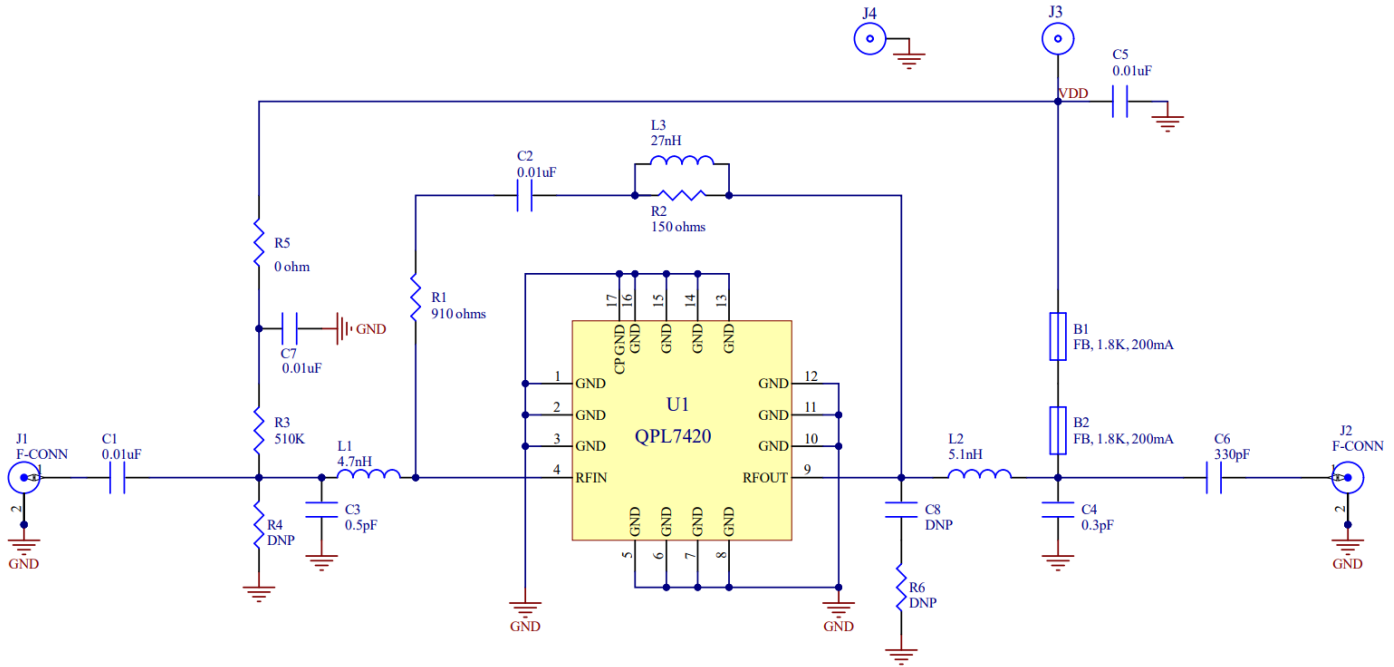

Evaluation Board Assembly Drawing, 47 – 1800MHz

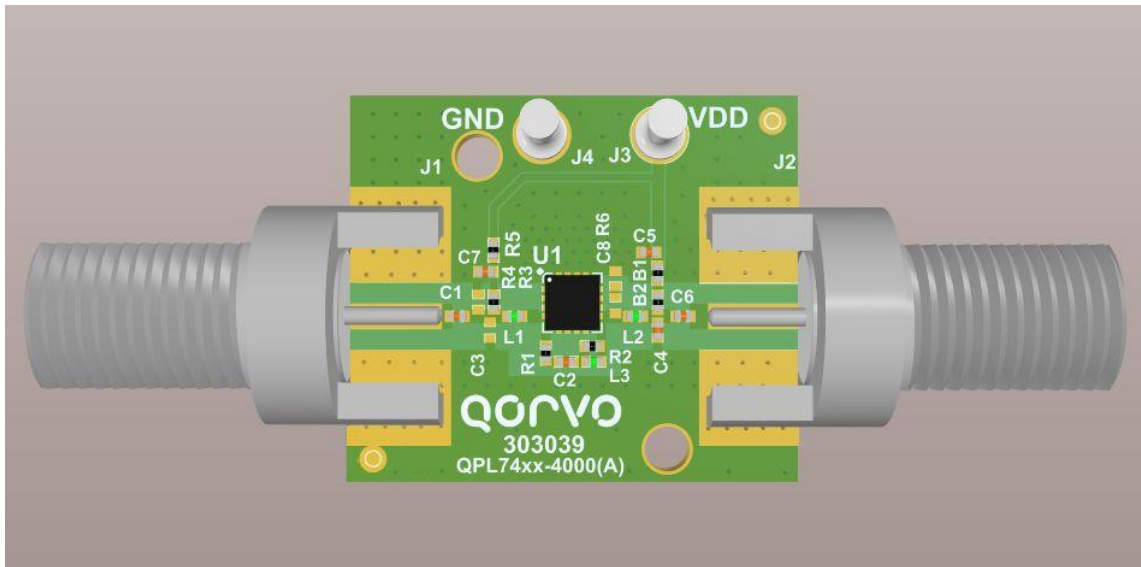



Evaluation Board Bill of Materials, 47 – 1800MHz

Designator	Description	Manufacturer	Part Number
PCB	QPL7420-4000	TTM	QPL7420-4000(A)
U1	20dB FTTH Amplifier	Qorvo	QPL7420
B1, B2	FER, BEAD, 1.8K, 200mA, 0402	TDK	MMZ1005A182ET000
C1, C2, C5, C7	CAP, 0.01uF, 10%, 50V, X7R, 0402	Murata Electronics	GCM155R71H103KA55D
C3	CAP, 0.5pF, ±0.05pF, 50V, HI-Q, 0402	Murata Electronics	GJM1555C1HR50WB01D
C4	CAP, 0.3pF, +/-0.05pF, 50V, HI-Q, 0402	Murata Electronics	GJM1555C1HR30WB01D
C6	CAP, 330pF, 10%, 50V, X8L, 0402	Murata Electronics	GCM155L81H331KA37D
J1, J2	CONN, F FEM EDGE MOUNT, 75 OHMS, 0.068"	Millimeter Wave Technologies, LLC	MW-846-C-DD-75
J3, J4	TERM. SOLDER TURRET, 0.062 PCB	Mill-Max Manufacturing	2533-0-00-44-00-00-07-0
L1	IND, 4.7nH, +/-0.3nH, M/L, 0402	Murata Electronics	LQG15HN4N7S02D
L2	IND, 5.1nH, +/- 0.3nH, 300mA, M/L, 0402	Murata Electronics	LQG15HS5N1S02D
L3	IND, 27nH, 5%, M/L, 0402	Murata Electronics	LQG15HN27NJ02D
R1	RES, 910 Ω, 5%, 1/16W, 0402	Panasonic Industrial	ERJ-2GEJ911X
R2	RES, 150 OHM, 5%, 1/16W, 0402	Kamaya, Inc	RMC1/16S-151JTH
R3	RES, 510K, 5%, 1/10W, 0402 510K	Kamaya, Inc	RMC 1/16S-514JTH
R5	RES, 0 OHM, 5%, 1/10W, 0402	Kamaya, Inc	RMC1/16SJPTH
C8, R4, R6	Not Populated		

Typical Application Schematic, 47 MHz – 1800 MHz

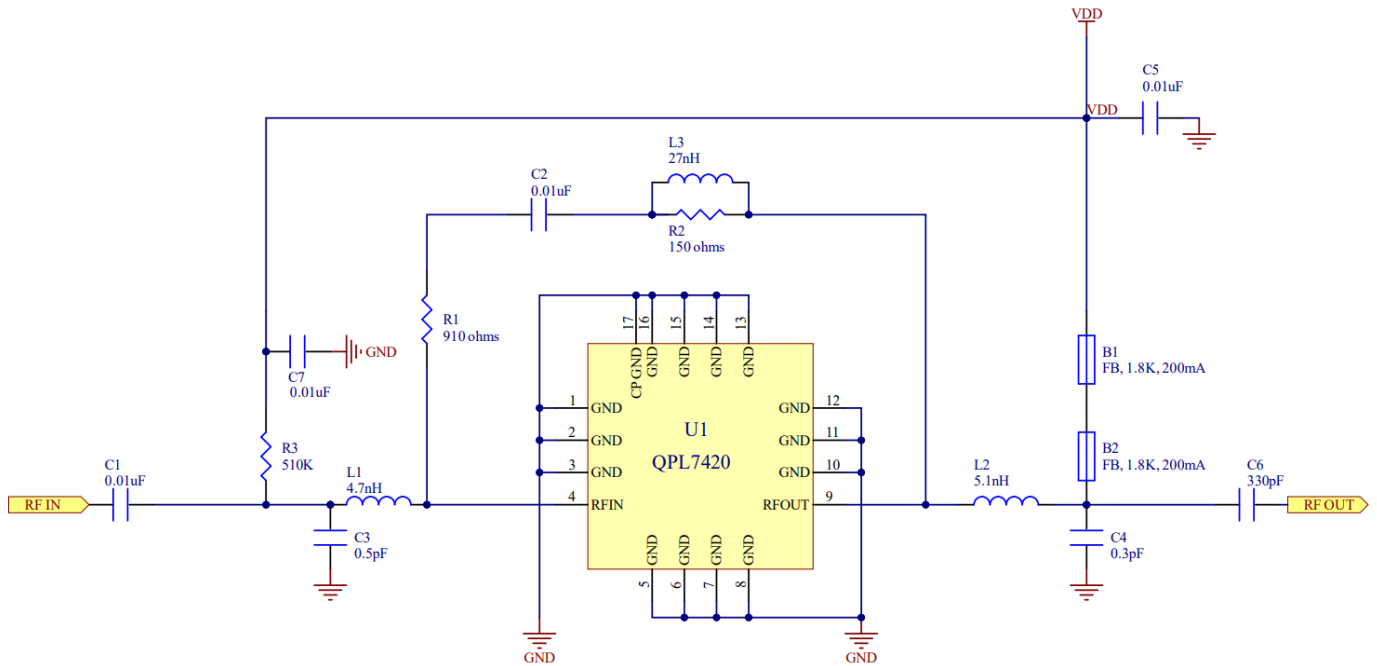

Notes:

1. C3/L1 tunes input return loss.
2. L2/ C4 tunes output return loss with some contribution from C6.
3. The feedback network is composed of R1 and R2, with C2 being a DC block and L3 providing high end peaking. The ratio of R1 to R2 controls flatness and tilt while the total feedback resistance affects device gain.
4. B1, B2 provides the bias path with RF isolation from the RF output path.
5. R3 is adjusted to increase linearity or shed power, trading off degraded noise figure and return loss.

Performance Data, 47 – 1800MHz (5 V)

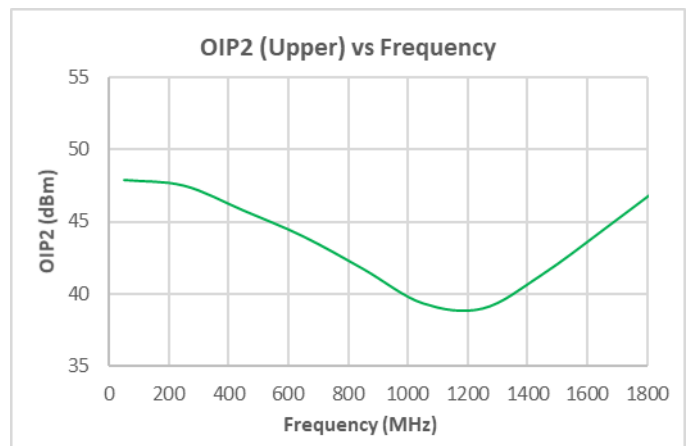
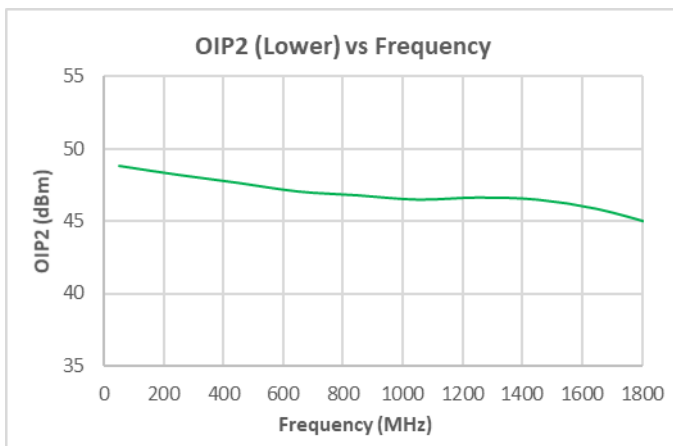
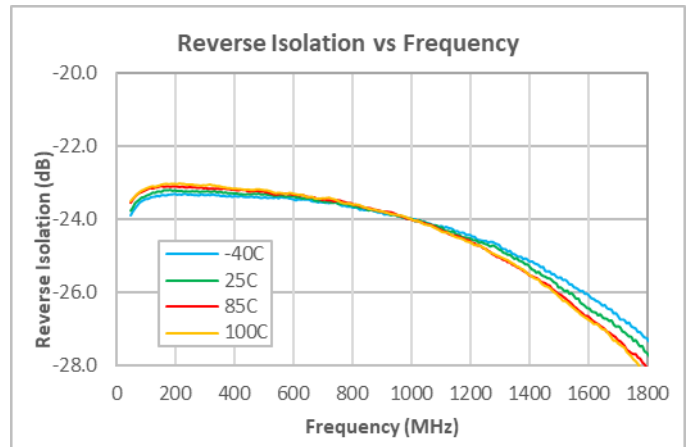
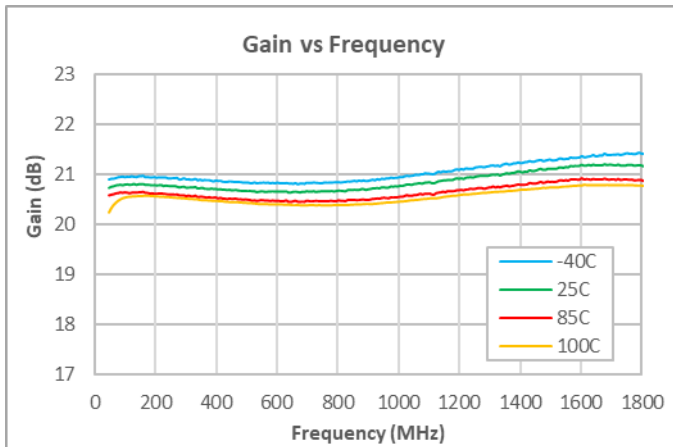
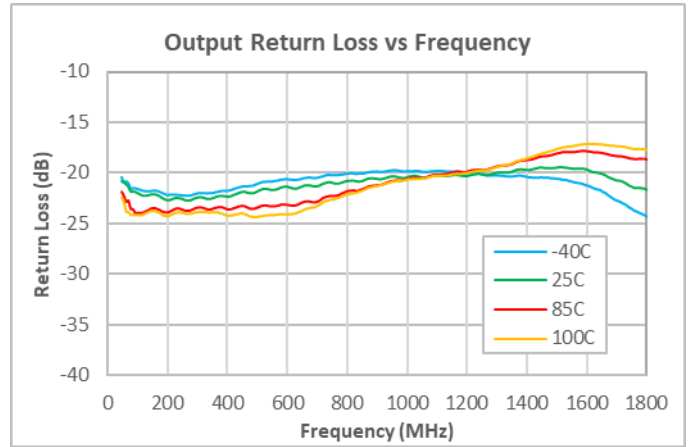
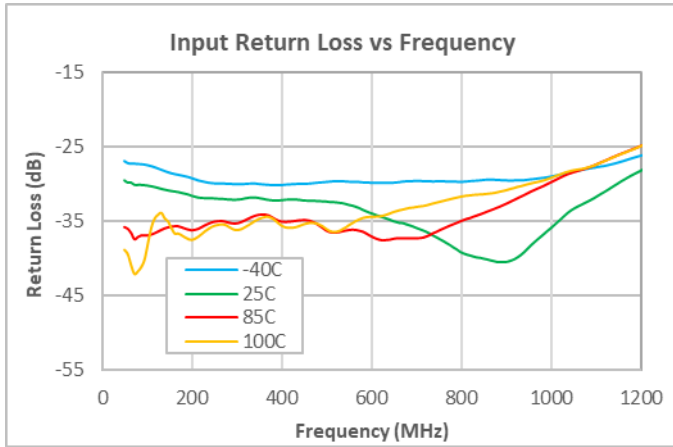

- Notes:
- (1) Temperature 25C unless otherwise noted, 75ohm test system, nominal current.
 - (2) OIP2: 9 dBm/tone output, 50MHz spacing.

Performance Data, 47 – 1800MHz (5 V)

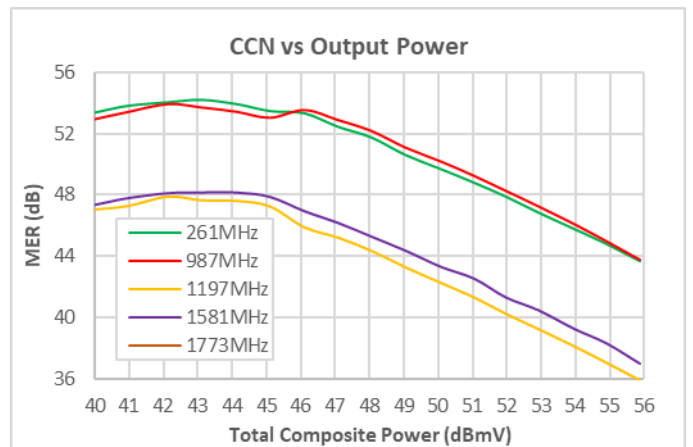
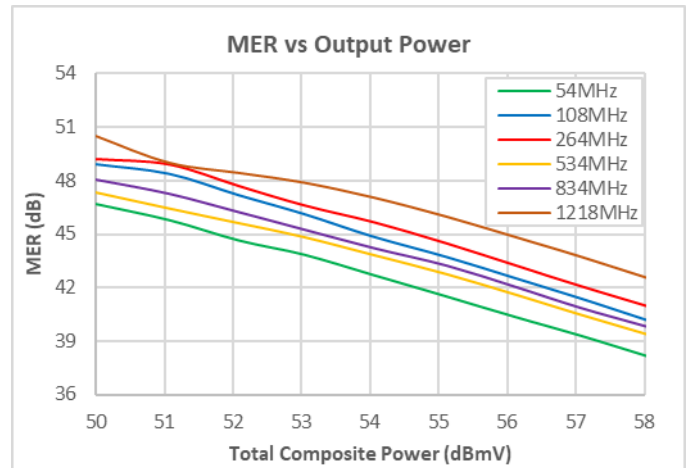
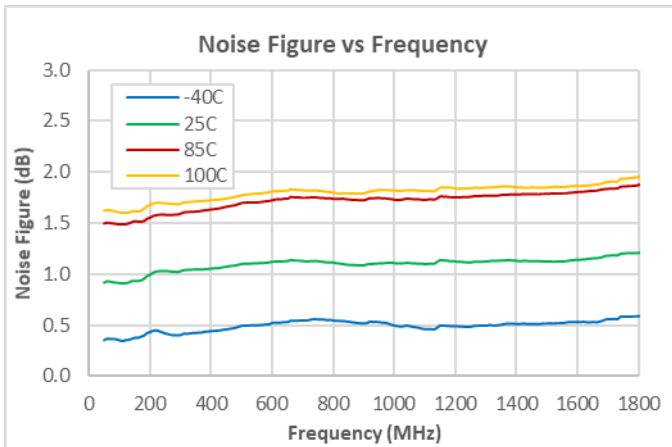
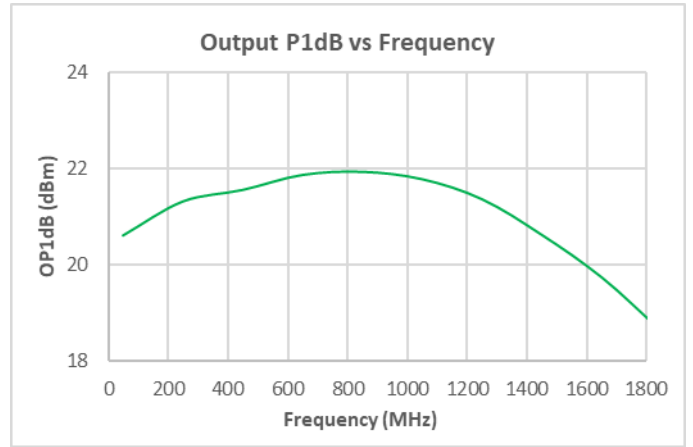
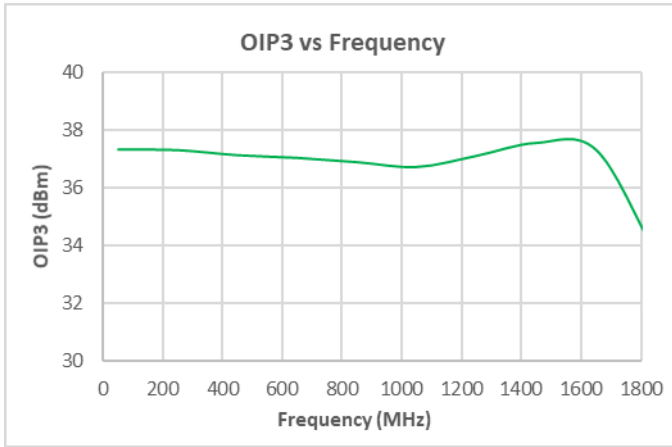

Notes:

- (1) 25°C unless otherwise noted, 75ohm test system, nominal current.
- (2) OIP3: 9 dBm/ tone output, 6MHz spacing.
- (3) MER: 190 QAM256 Channels, 57-1218MHz, ITU-T J.83, Annex B, Source Corrected, Maximum Correction 4.3dB.

Performance Data, 47 – 1800MHz (8 V)

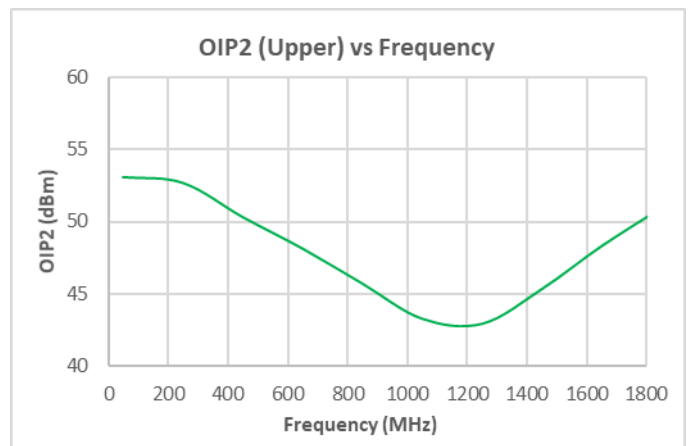
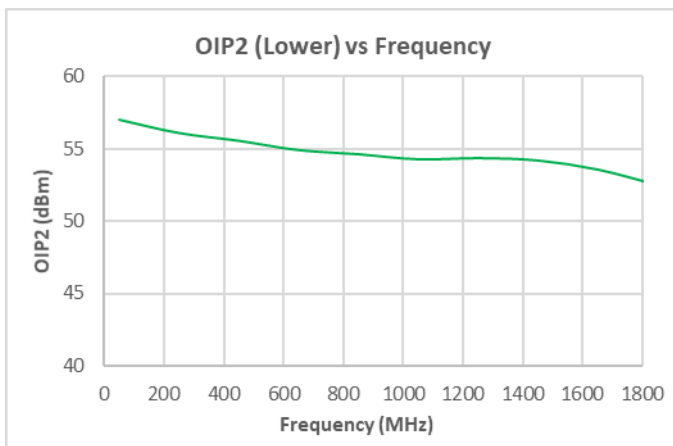
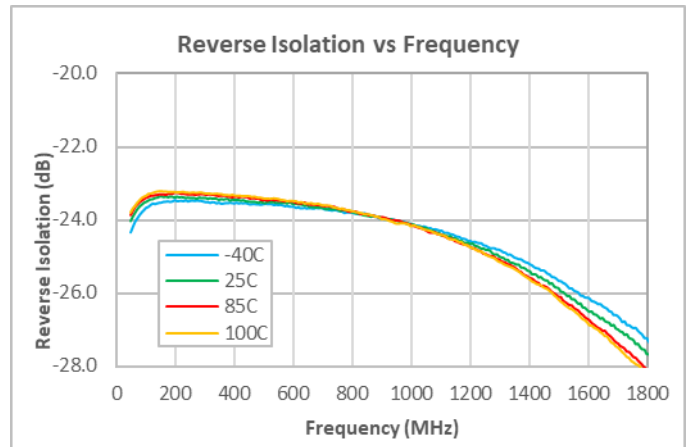
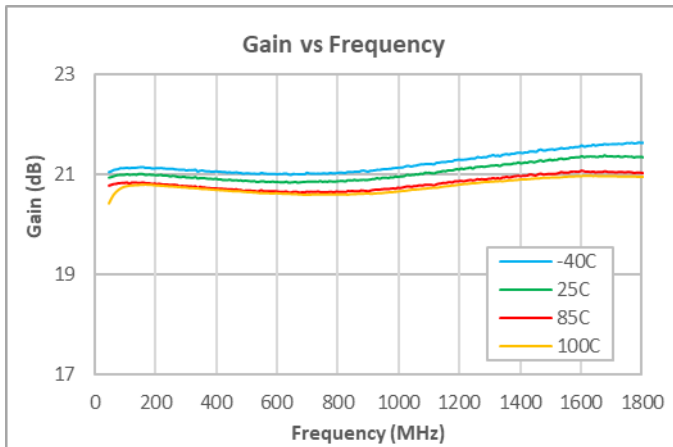
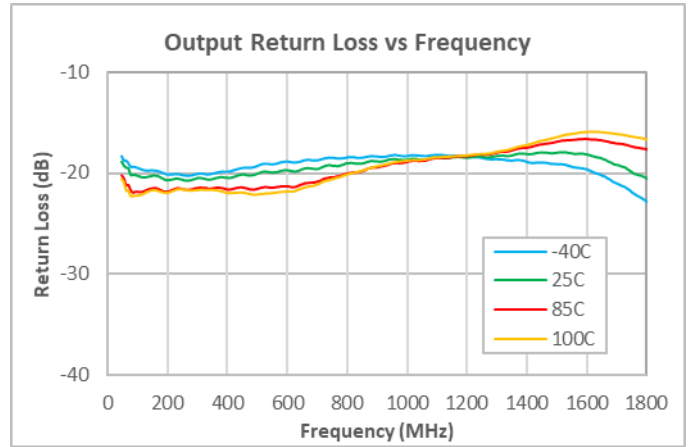
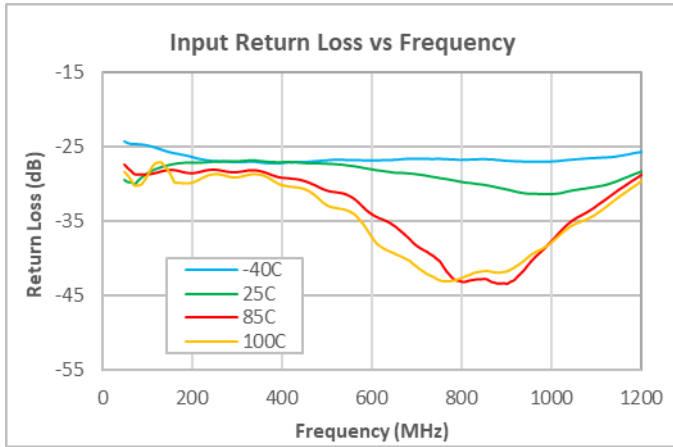

- Notes:
- (1) Temperature 25C unless otherwise noted, 75ohm test system, nominal current.
 - (2) OIP2: 9 dBm/tone output, 50MHz spacing.

Performance Data, 47 – 1800MHz (8 V)

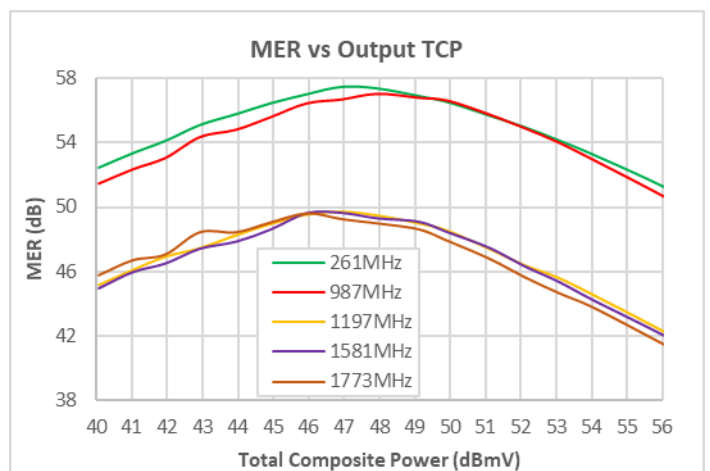
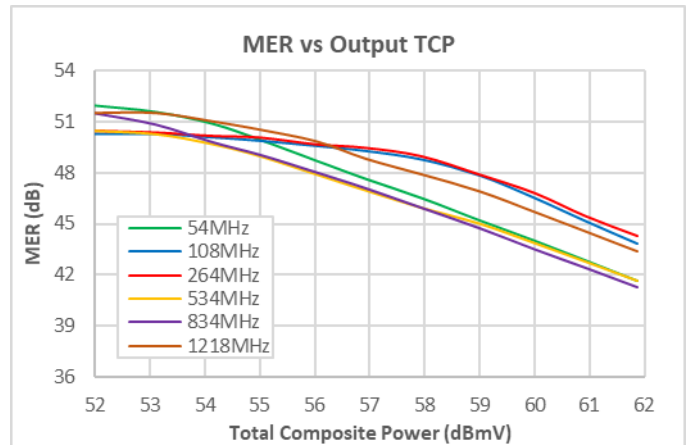
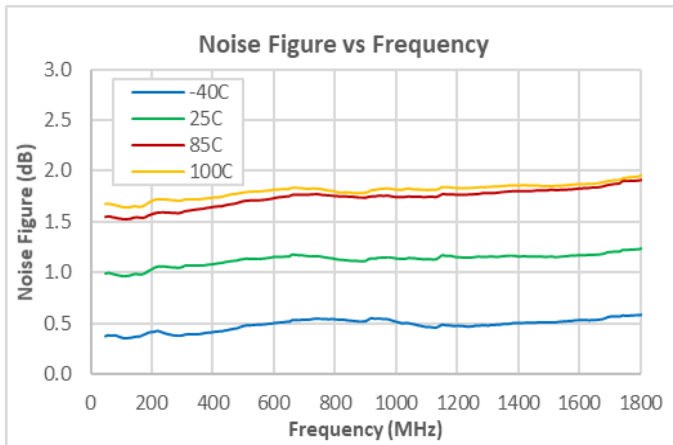
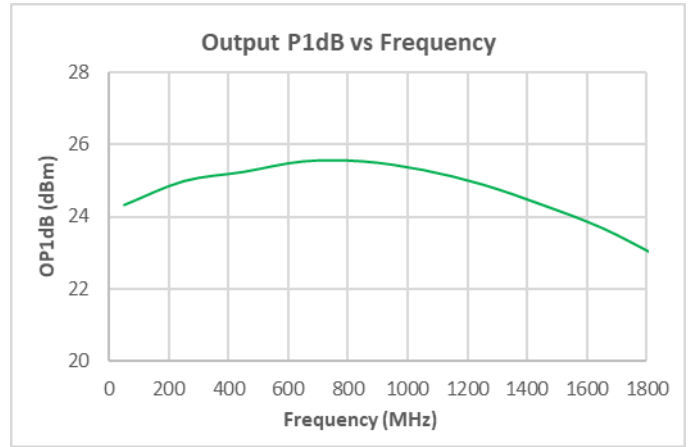
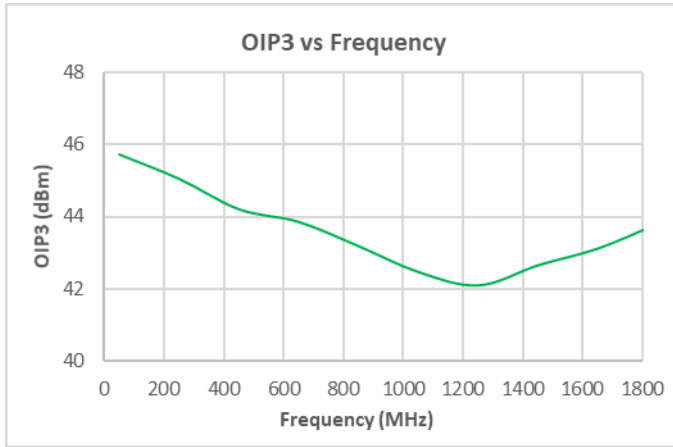

Notes:

- (1) 25°C unless otherwise noted, 75ohm test system, nominal current.
- (2) OIP3: 9 dBm / tone output, 6MHz spacing.
- (3) MER: 190 QAM256 Channels, 57-1218MHz, ITU-T J.83, Annex B, Source Corrected, Maximum Correction 4.3dB.

Performance Data vs Supply Voltage

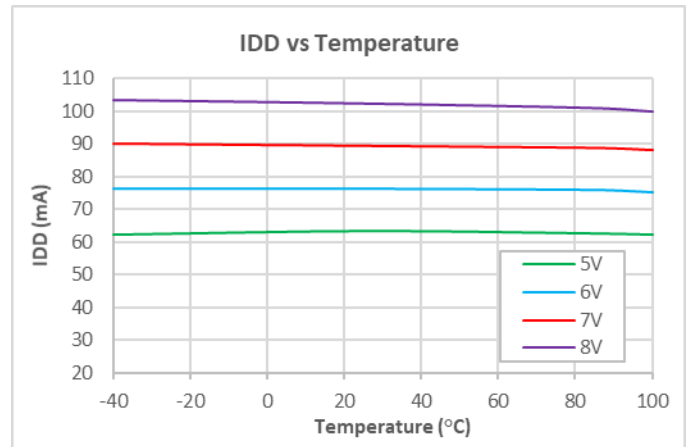
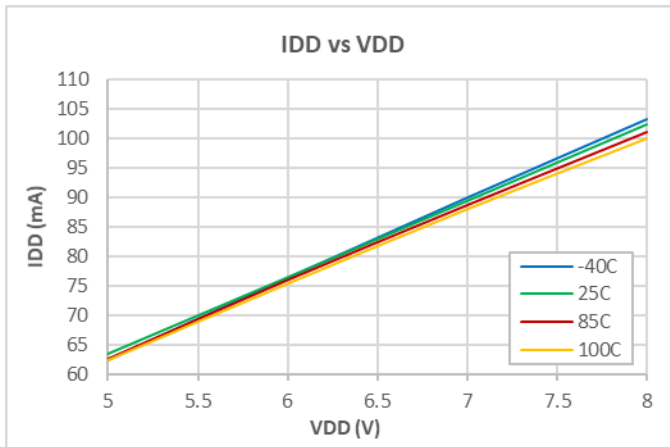

Notes:
 (1) 25°C, 75ohm test system.

Electrical Specifications, 5MHz – 700MHz (5 V)

Parameter	Condition ⁽¹⁾	Min	Typ	Max	Unit
Supply Voltage (V_{DD})			5		V
Supply Current (I_{DD})			63		mA
Frequency Range		5		700	MHz
Gain			20.8		dB
Gain Slope			0.2		dB
Reverse Isolation			-23		dB
Input Return Loss			24.7		dB
Output Return Loss			17.8		dB
Noise Figure			1.3		dB
OIP2L			46.5		dBm
OIP2H			42.8		dBm
OIP3			33.9		dBm
OP1dB	204MHz		21.4		dBm
Thermal Resistance	Θ_{JC} , Bottom of Case		27		$^{\circ}\text{C/W}$

Notes:

1. Typical performance at these conditions: Temp = +25 $^{\circ}\text{C}$, V_{DD} = +5V, 75 Ω system, Full band unless otherwise noted
2. OIP3; +9dBm/ tone output, 6MHz spacing
3. OIP2; +9dBm/tone output, 6MHz spacing

Electrical Specifications, 5MHz – 700MHz (8 V)

Parameter	Condition ⁽¹⁾	Min	Typ	Max	Unit
Supply Voltage (V_{DD})			8		V
Supply Current (I_{DD})			102		mA
Frequency Range		5		700	MHz
Gain			21.0		dB
Gain Slope			0.1		dB
Reverse Isolation			23		dB
Input Return Loss			22		dB
Output Return Loss			16		dB
Noise Figure			1.3		dB
OIP2L			54.0		dBm
OIP2H			48.4		dBm
OIP3			41.5		dBm
OP1dB	204MHz		25.1		dBm
Thermal Resistance	Θ_{JC} , Bottom of Case		27		$^{\circ}\text{C/W}$

Notes:

1. Typical performance at these conditions: Temp = +25 $^{\circ}\text{C}$, V_{DD} = +5V, 75 Ω system, Full band unless otherwise noted
2. OIP3; +9dBm/ tone output, 6MHz spacing
3. OIP2; +9dBm/tone output, 6MHz spacing

Return Path Schematic (5 – 700MHz)

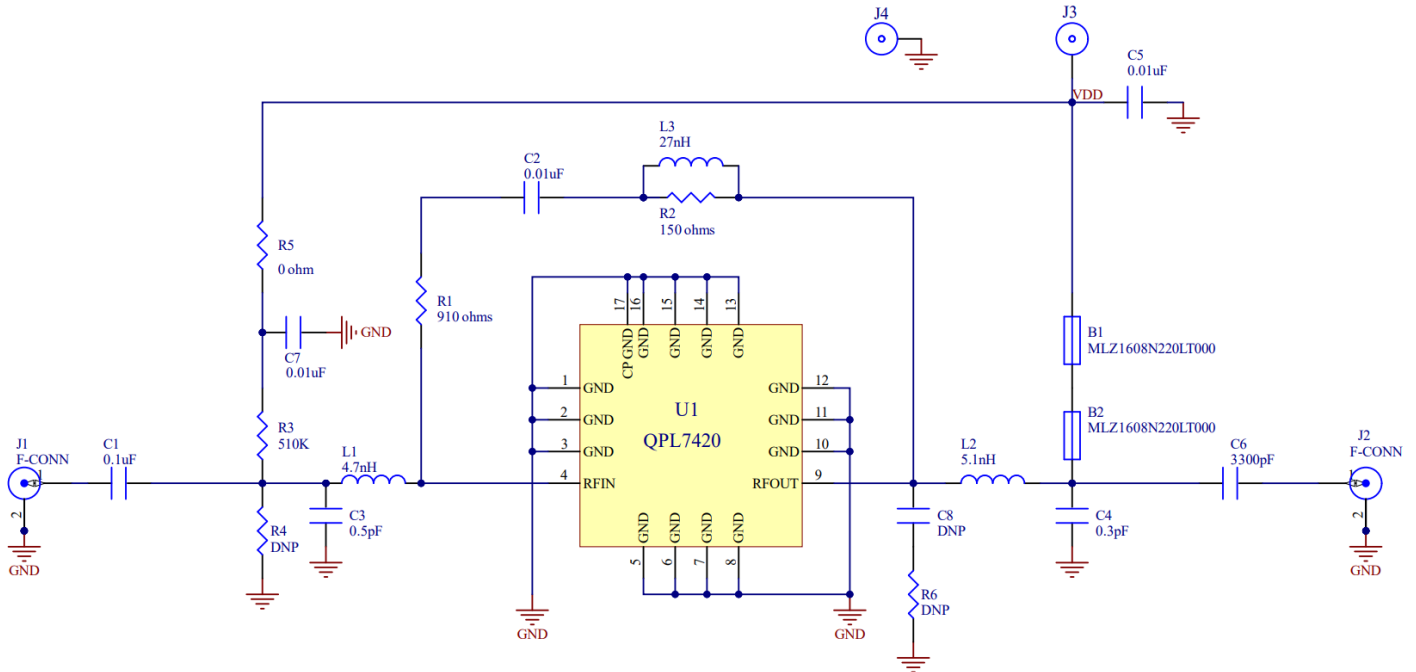

Notes:

1. C3/L1 tunes input return loss.
2. L2/C4 tunes output return loss with some contribution from C6.
3. R1/L3 sets the level of feedback while B1, L4 provides the bias path with RF isolation from the RF output path.
4. R2 helps control high end tilt/peaking.
5. R3 increases bias current for improved linearity and NPR dynamic range.

Return Path Evaluation Board Assembly Drawing

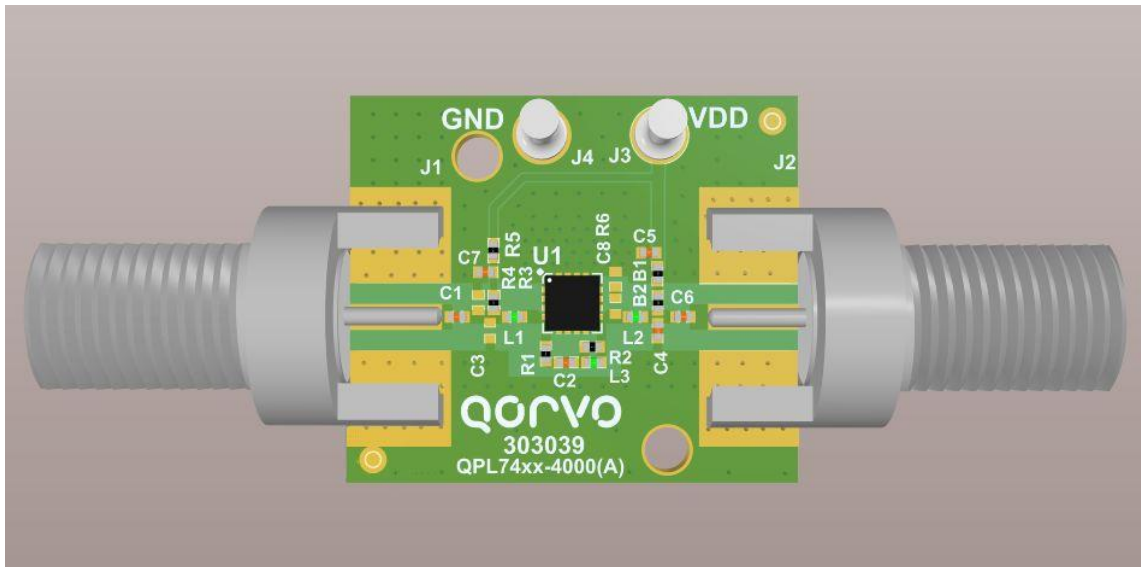

Return Path Evaluation Board Bill of Materials

Designator	Description	Manufacturer	Part Number
PCB	QPL7420-4000	TTM	QPL7420-4000(A)
U1	20dB FTTH Amplifier	Qorvo	QPL7420
B1, B2	FER BEAD, 22uH, 20%, 190mA, 0603	TDK	MLZ1608N220LT000
C1	CAP, 0.1uF, 10%, 50V, X7R, 0402	Murata Electronics	GCM155R71H104KA55D
C2, C5, C7	CAP, 0.01uF, 10%, 50V, X7R, 0402	Murata Electronics	GCM155R71H103KA55D
C3	CAP, 0.5pF, ±0.05pF, 50V, HI-Q, 0402	Murata Electronics	GJM1555C1HR50WB01D
C4	CAP, 0.3pF, +/-0.05pF, 50V, HI-Q, 0402	Murata Electronics	GJM1555C1HR30WB01D
C6	CAP, 3300pF, 10%, 50V, X8L, 0402	Murata Electronics	GCM155L81H332MA37J
J1, J2	CONN, F FEM EDGE MOUNT, 75 OHMS, 0.068"	Millimeter Wave Technologies, LLC	MW-846-C-DD-75
J3, J4	TERM. SOLDER TURRET, 0.062 PCB	Mill-Max Manufacturing	2533-0-00-44-00-00-07-0
L1	IND, 4.7nH, +/-0.3nH, M/L, 0402	Murata Electronics	LQG15HN4N7S02D
L2	IND, 5.1nH, +/- 0.3nH, 300mA, M/L, 0402	Murata Electronics	LQG15HS5N1S02D
L3	IND, 27nH, 5%, M/L, 0402	Murata Electronics	LQG15HN27NJ02D
R1	RES, 910 Ω, 5%, 1/16W, 0402	Panasonic Industrial	ERJ-2GEJ911X
R2	RES, 150 OHM, 5%, 1/16W, 0402	Kamaya, Inc	RMC1/16S-151JTH
R3	RES, 510K, 5%, 1/10W, 0402 510K	Kamaya, Inc	RMC 1/16S-514JTH
R5	RES, 0 OHM, 5%, 1/10W, 0402	Kamaya, Inc	RMC1/16SJPTH
C8, R4, R6	Not Populated		

Performance Data, 5 – 700MHz (5V)

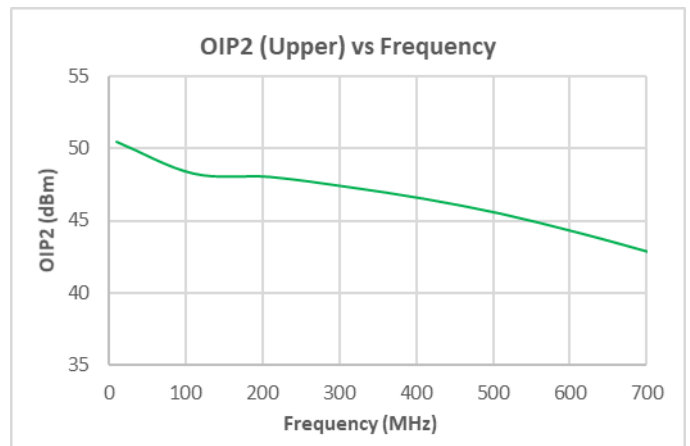
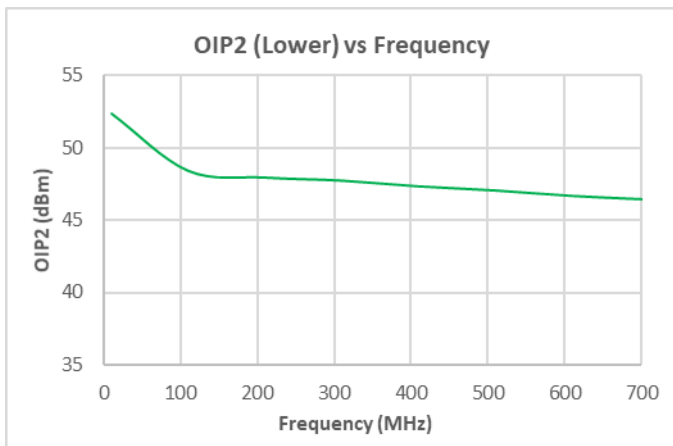
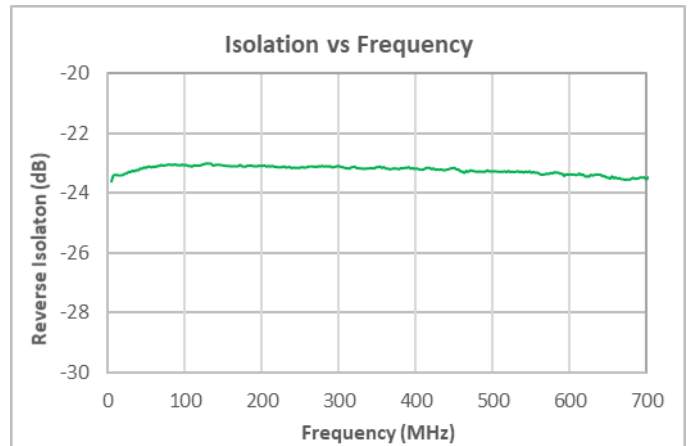
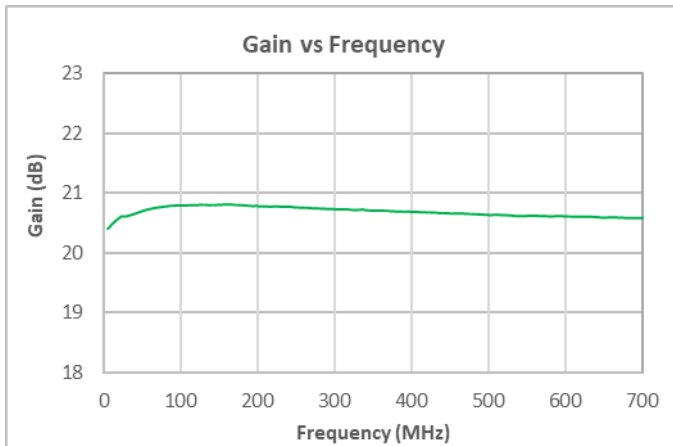
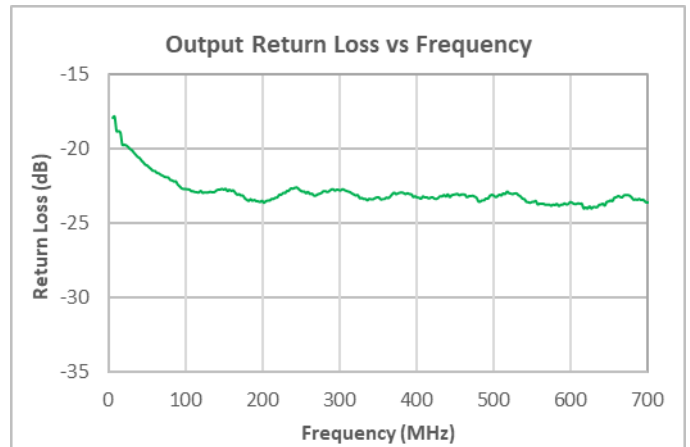
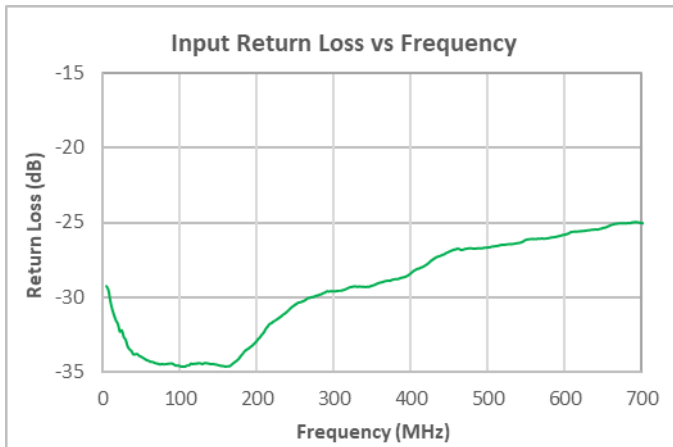

Notes:

- (1) 25C unless otherwise noted, 75ohm test system, nominal current unless otherwise noted.
- (2) OIP2; +9dBm/tone output, 6MHz spacing

Performance Data, 5 – 700MHz (5V)

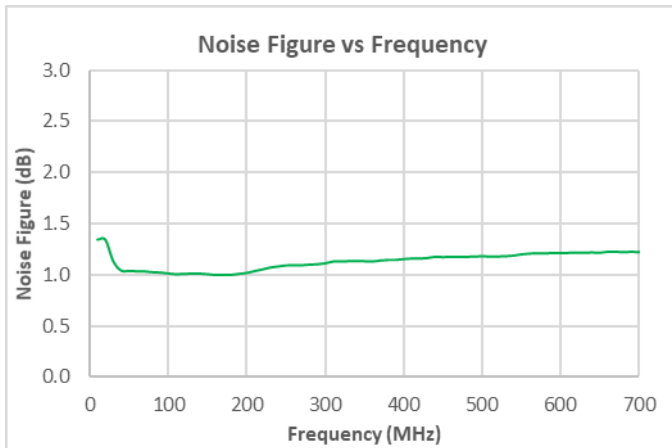
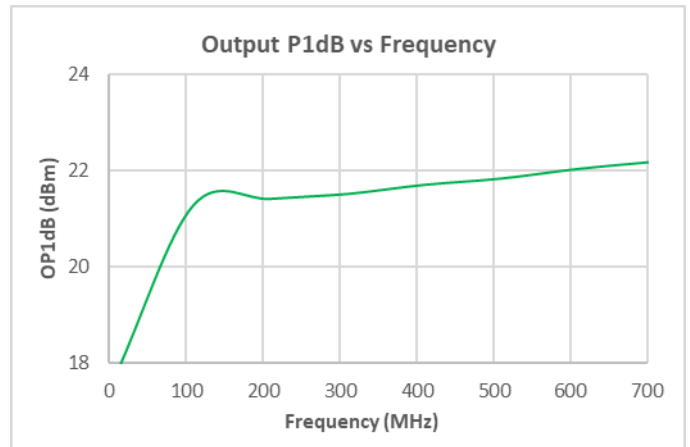
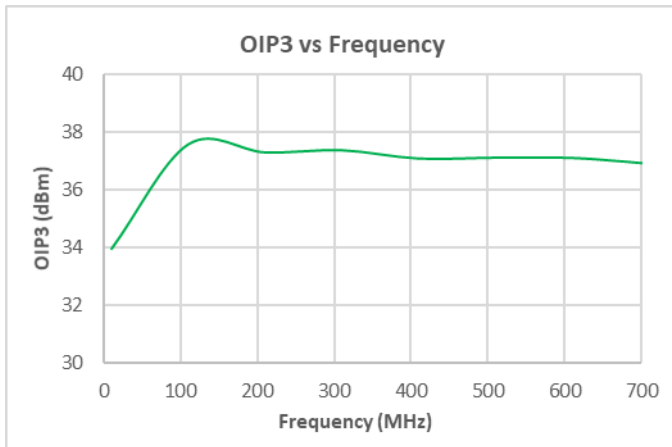

Notes:

- (1) 25°C unless otherwise noted, 75ohm test system, nominal current unless otherwise noted.
- (2) OIP3; +9dBm/tone output, 6MHz spacing

Performance Data, 5 – 700MHz (8V)

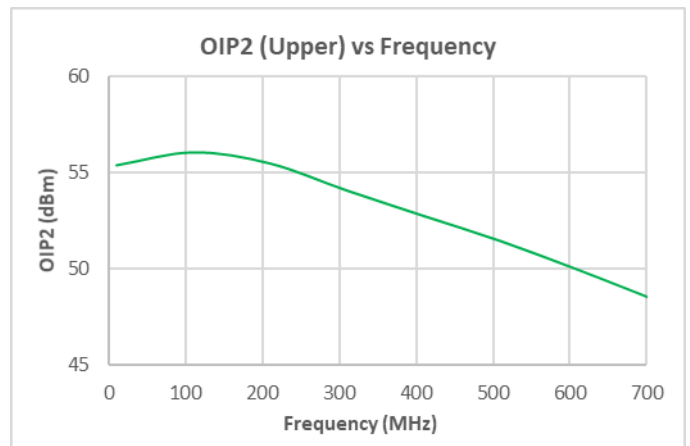
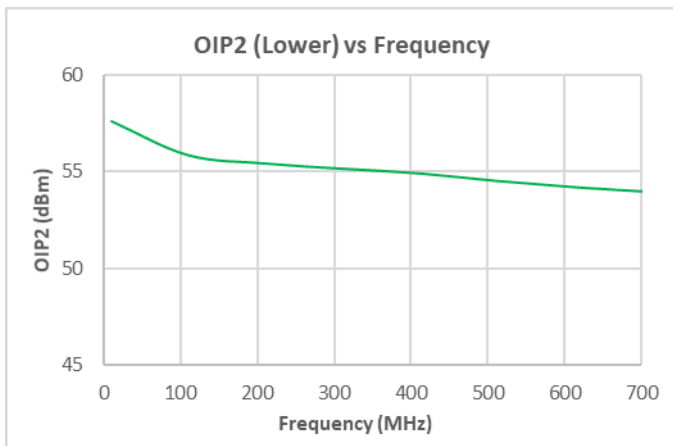
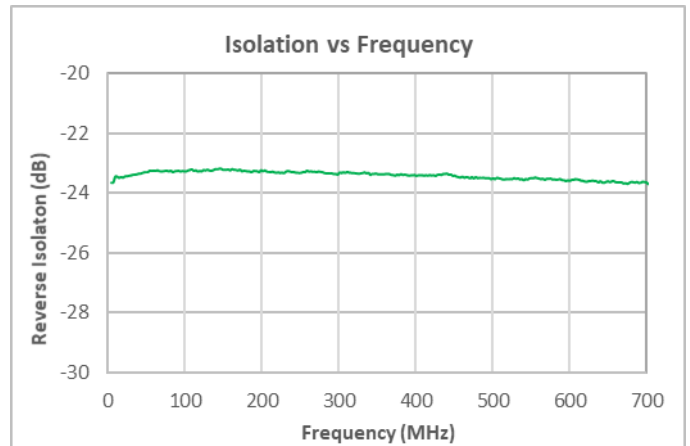
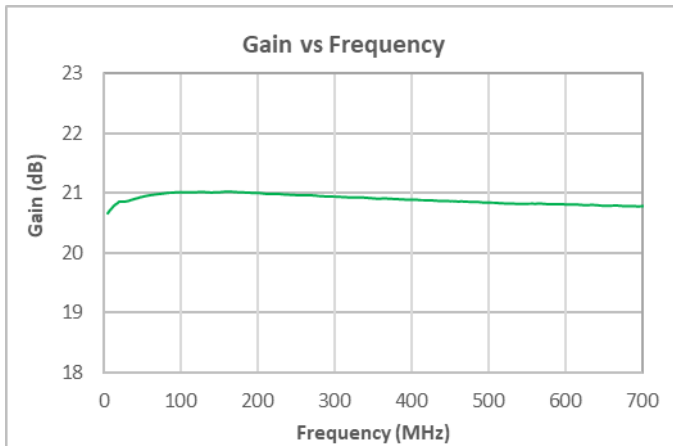
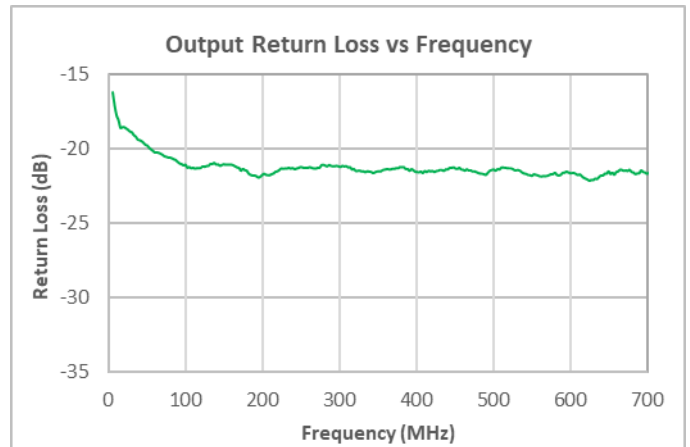
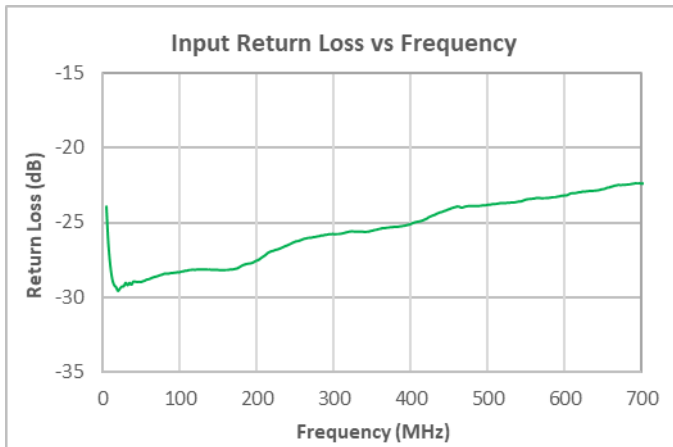

Notes:

- (1) 25C unless otherwise noted, 75ohm test system, nominal current unless otherwise noted.
- (2) OIP2; +9dBm/tone output, 6MHz spacing

Performance Data, 5 – 700MHz (8V)

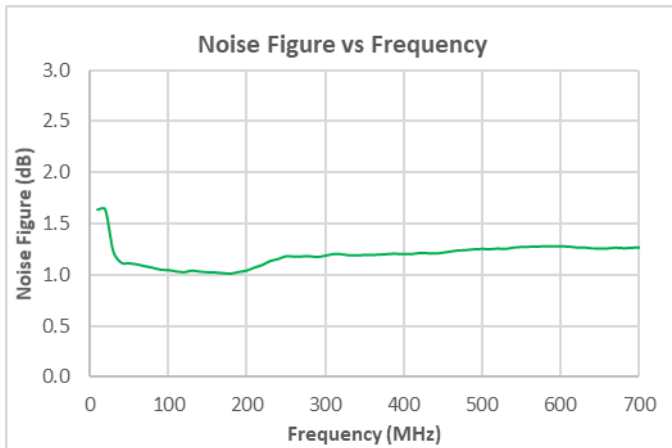
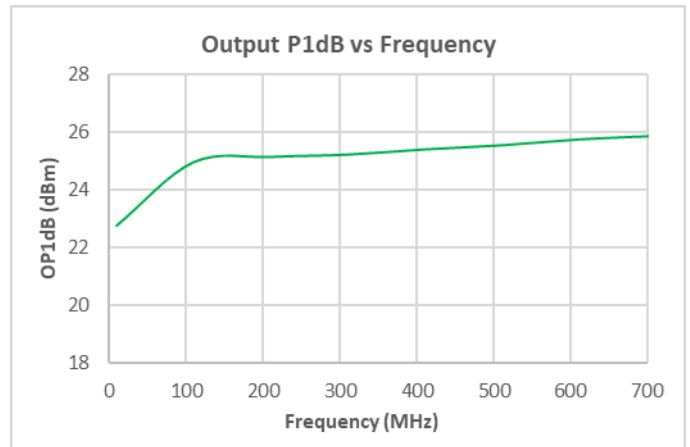
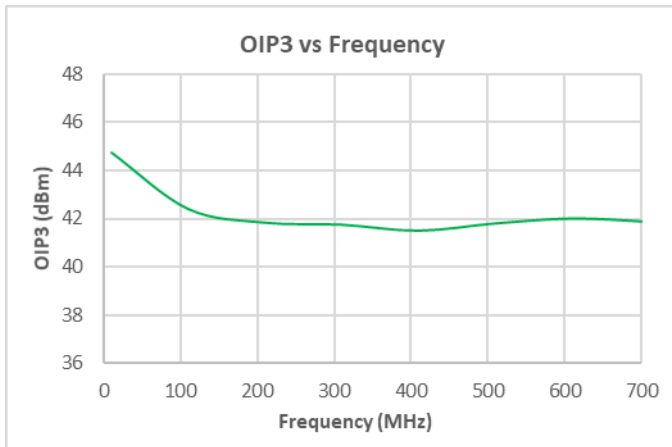

Notes:

- (1) 25°C unless otherwise noted, 75ohm test system, nominal current unless otherwise noted.
- (2) OIP3; +9dBm/tone output, 6MHz spacing

Pin Configuration and Description

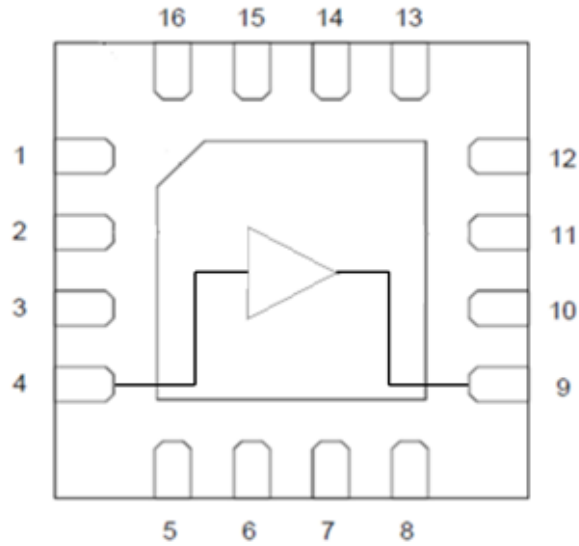

Top View

Pin Number	Label	Description
4	RF IN	RF Input, DC blocking capacitor required.
9	RF OUT / VDD	RF Output – VDD bias choke required.
1 - 3, 5-8, 10-16	GND	Internally Not Connected.
Backside Paddle	GND	Ground. Use recommended via pattern to minimize inductance and thermal resistance. See PCB Mounting Pattern for suggested footprint.

Package Outline

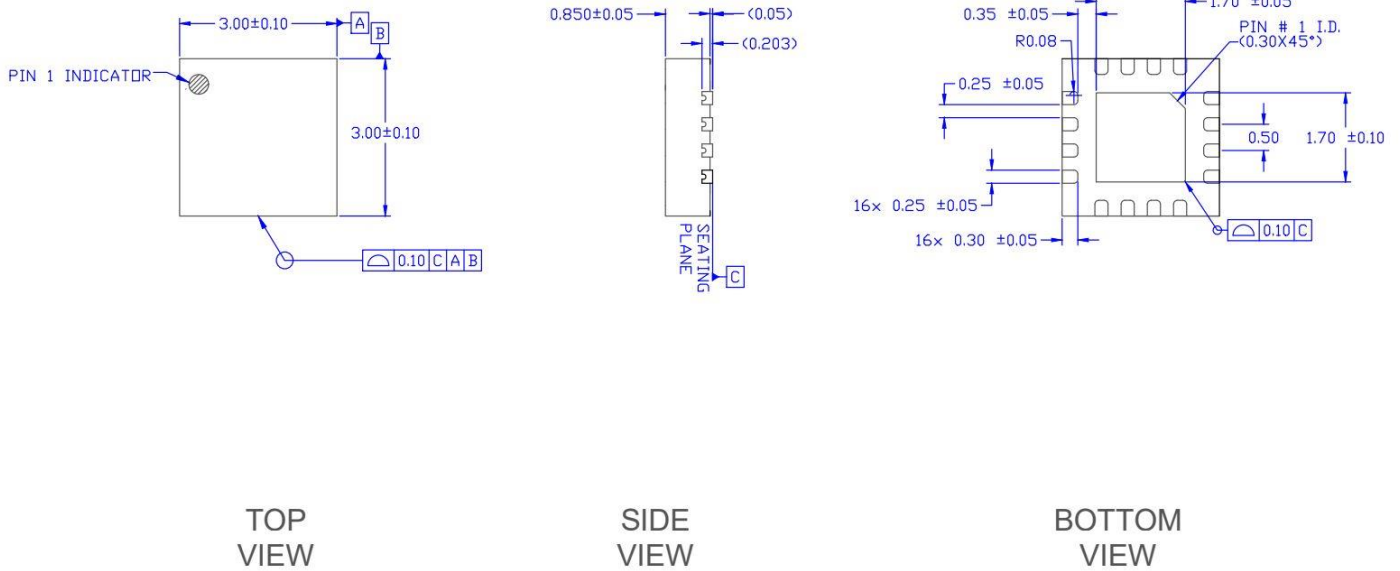

Recommended Mounting Pattern

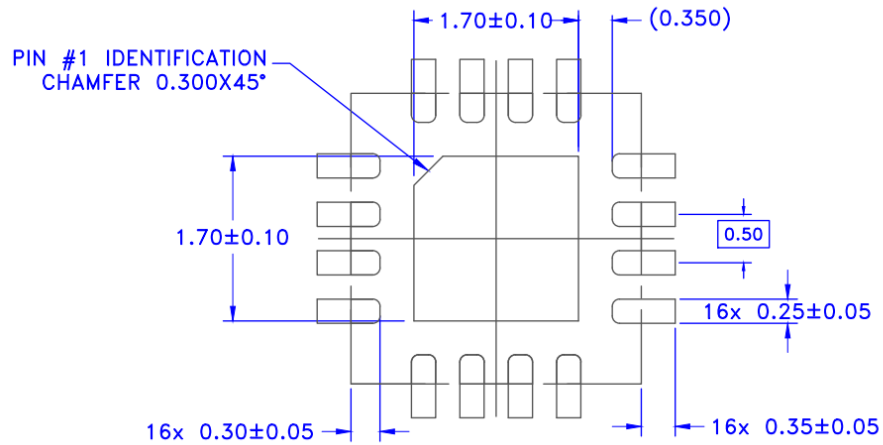

Package Marking

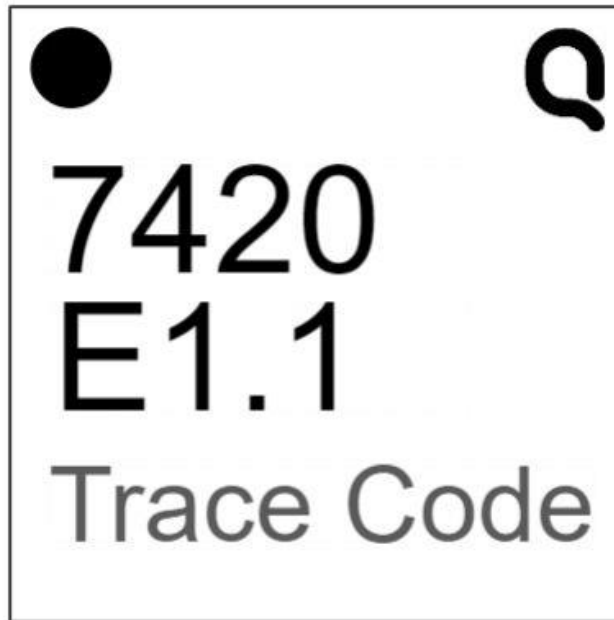

- Pin 1 Indicator
Qorvo Logo - Use Q5D
Trace Code to be assigned by SubCon

Handling Precautions

Parameter	Rating	Standard
ESD – Human Body Model (HBM)	Class 1B (500V to < 1000V)	ANSI/ESDA/JEDEC JS-001
ESD – Charged Device Model (CDM)	Class C3 (≥1000V)	ANSI/ESDA/JEDEC JS-002
MSL – Moisture Sensitivity Level	Level 2	IPC/JEDEC J-STD-020



Caution!
ESD-Sensitive
Device

Solderability

Compatible with both lead-free (260 °C max. reflow temp.) and tin/lead (245 °C max. reflow temp.) soldering processes. Solder profiles available upon request.

Contact plating: NiPdAu

RoHS Compliance

This part is compliant with 2011/65/EU RoHS directive (Restrictions on the Use of Certain Hazardous Substances in Electrical and Electronic Equipment) as amended by Directive 2015/863/EU.

This product also has the following attributes:

- Lead Free
- Halogen Free (Chlorine, Bromine)
- Antimony Free
- TBBP-A (C₁₅H₁₂Br₄O₂) Free
- PFOS Free
- SVHC Free



Contact Information

For the latest specifications, additional product information, worldwide sales and distribution locations:

Tel: 1-844-890-8163

Web: www.qorvo.com

Email: customer.support@qorvo.com

Important Notice

The information contained in this Data Sheet and any associated documents (“Data Sheet Information”) is believed to be reliable; however, Qorvo makes no warranties regarding the Data Sheet Information and assumes no responsibility or liability whatsoever for the use of said information. All Data Sheet Information is subject to change without notice. Customers should obtain and verify the latest relevant Data Sheet Information before placing orders for Qorvo® products. Data Sheet Information or the use thereof does not grant, explicitly, implicitly or otherwise any rights or licenses to any third party with respect to patents or any other intellectual property whether with regard to such Data Sheet Information itself or anything described by such information.

DATA SHEET INFORMATION DOES NOT CONSTITUTE A WARRANTY WITH RESPECT TO THE PRODUCTS DESCRIBED HEREIN, AND QORVO HEREBY DISCLAIMS ANY AND ALL WARRANTIES WITH RESPECT TO SUCH PRODUCTS WHETHER EXPRESS OR IMPLIED BY LAW, COURSE OF DEALING, COURSE OF PERFORMANCE, USAGE OF TRADE OR OTHERWISE, INCLUDING THE IMPLIED WARRANTIES OF MERCHANTABILITY AND FITNESS FOR A PARTICULAR PURPOSE. Without limiting the generality of the foregoing, Qorvo® products are not warranted or authorized for use as critical components in medical, life-saving, or life-sustaining applications, or other applications where a failure would reasonably be expected to cause severe personal injury or death. Applications described in the Data Sheet Information are for illustrative purposes only. Customers are responsible for validating that a particular product described in the Data Sheet Information is suitable for use in a particular application.

© 2022 Qorvo US, Inc. All rights reserved. This document is subject to copyright laws in various jurisdictions worldwide and may not be reproduced or distributed, in whole or in part, without the express written consent of Qorvo US, Inc. | QORVO® is a registered trademark of Qorvo US, Inc.

Mouser Electronics

Authorized Distributor

Click to View Pricing, Inventory, Delivery & Lifecycle Information:

[Qorvo:](#)

[QPL7420EVB-01](#)