

**Amphenol**  
SINESYSTEMS

# RT360™

Circular Connectors



INTERCONNECTING YOUR WORLD



We are Amphenol Sine Systems.

We are a global leader in providing you with interconnection options and solutions.

We fulfill the needs of Industrial, Factory Automation, Heavy Duty and Custom-design markets.

Amphenol Sine Systems, with its 42 year history, 325+ employees worldwide and 3 global facilities, draws on the extensive worldwide resources of Amphenol Corporation to find solutions for our customers. Our engineers design innovative combinations of industry standard connectors and application specific shielding components to create assembly systems that set the standards for performance, reliability, and cost effectiveness. Our engineering, materials, and manufacturing organizations meet the high standards imposed by ISO 9001 as well as many customer specific quality systems. Our performance has earned us ship to stock and world class performance awards from many major OEMs.



Amphenol Sine Systems is a division of **Amphenol Corporation** ([www.amphenol.com](http://www.amphenol.com)), one of the largest interconnect solution suppliers in the world. Amphenol Corporation supplies a wide range of product solutions worldwide. Amphenol Corporation, and all its subsidiaries, design, manufacture and market electrical, electronic and fiber-optic connectors, interconnect systems and coaxial and specialty cable. Amphenol has a diversified presence in high growth markets including: Information Technology and Data Communications Equipment, Mobile Devices, Mobile Networks, Broadband Communication, Military and Commercial Aerospace, Industrial and Automotive.



## Table of Contents

Description.....	1
Features & Benefits.....	1
Part Ordering Guide - RT & RTHP Series Plugs and Receptacles .....	2
Part Ordering Guide - RT Series Machined Contacts .....	3
Part Ordering Guide - RT Series Stamped & Formed Contacts .....	4
Radsok® Technical Information .....	5
Part Ordering Guide - RTHP Series Machined Contacts.....	6
RTHP Series Typical Product Picture and Installation Dimension.....	6
Insert Configurations .....	7
Box and Wall Mounts .....	8
Straight Plugs .....	8
Jam Nut Receptacle .....	9
Cord Grips.....	9
Metal Cable Clamp Cord Grip .....	10
Wall Mounted Receptacle for Flat Hole Tail .....	11
Straight Cable Plug with Cord Grip Solution.....	11
Straight Cable Plug with End Cap .....	12
Straight Cable Plug with 90° Cord Grip Solution .....	12
Accessories & Tooling -	
Dust Caps.....	13
Sealing Plugs.....	13
Universal Hand Crimp Tool.....	13
Stamp Contact Tool .....	13
Contact Extraction Tool .....	13
Crimp Die .....	14
Pneumatic Crimp Tool.....	14
Gaskets.....	14
Worldwide Company Locations .....	Back Cover

© 2011 Amphenol Sine Systems Corporation. Every effort has been made to ensure that the information contained in this catalog is accurate at the time of publication. Specifications or information stated in this publication are subject to change without notice.

## Description

RT360™ industrial circular connectors are multiway connector available in 6 shell sizes and 22 insert arrangements with a variety of wire gauge options. RT360 industrial circular connectors were designed to be intermateable with other industrial connector families.

Shells	Zinc Alloy
Backshells and Cable Glands	
Coupling Ring	Aluminum
Coupling Spring	Spring Stainless Steel
Interfacial Seal	Standard: NBR / Optional: Silicone
Insert	Glass-filled Thermoplast UL94-V0
Finish	Nickel
RoHS Compliant	Yes
Operating Temp	NBR: -40°C to +105°C / Silicone: -45°C to +125°C
Insulation Resistance	5000 MΩ min.
Durability	500 matings and unmatings
Vibration Resistance	per MIL-STD202 method 204
Thermal Shock	per MIL-STD202 method 207
Corrosion	Salt spray per MIL-STD 202, method 101; 48h (standard version), 96h (black anodized coupling ring) <b>*Higher salt spray resistance (200/500h) upon request.</b>
Degree of Water Protection per DIN 40050	IP67 in mated condition and in combination with sealed back shell. *Consult Factory for additional Degree of Protection

## Features & Benefits



RT Series



RTHP Series

### RT Series - 20AWG

- High density arrangements from 6-41 contacts
- 6 shell sizes and 6 insert configurations
- Operating voltage of 150V
- Current rating of 7.5A with machined contacts and 5A with stamped and formed contacts
- Alternate keying positions available
- Plastic inserts with flammability rating of UL94-V0
- RoHS compliant

### RT Series - 16AWG

- 16AWG and mixed Power and Signal arrangements from 4-28 contacts
- 6 shell sizes and 11 insert configurations
- Operating voltage of 300V
- Current rating: 13A(signal contacts)
- Alternate keying positions available
- Plastic inserts with flammability rating of UL94-V0
- RoHS compliant

### RTHP Series

- Single pole High Power arrangements
- 4 shell sizes and 5 insert configurations
- 3.6mm-10mm contact sizes
- Operating voltage of 630V
- Current rating at 80°C: 86A-342A
- Plastic inserts with flammability rating of UL94-V0
- RoHS compliant

# Part Ordering Guide - RT & RTHP Series Plugs & Receptacles

SERIES	STYLE	SHELL TYPE	INSERT ARRANGEMENT	TYPE OF CONTACTS	INSERT POLARIZATION	APPLICATION	DESIGN VARIATION	PLATING	INTERFACIAL SEAL VARIATION
*	*	*	*	*	*	*	*	*	*

## RT SERIES

### SERIES

- RT

### SHELL TYPE

- 0: Wall mount recep.
- 1: Inline receptacle
- 6: Cable plug
- 7: Jam nut recep. / rear panel mount

### SHELL SIZE

- 10, 12, 14, 16, 18, 20

### INSERT ARRANGEMENT

- See Page 7

### TYPE OF CONTACTS

- P: Pin contacts
- S: Socket contacts

### INSERT POLARIZATION (See Detail below)

- N: Standard version
- W, X, Y, Z: Custom orientation (consult Factory)

### APPLICATION

- Blank: Standard version (no o-ring)
- H: Standard version, water protection IP67

### DESIGN VARIATION

- Blank: Standard version
- EC: End cap & standard seal for wire 18~14AWG
- MM: End cap & reduced seal for wire 24~20AWG

### PLATING

- Blank: Standard is nickel plating (48hr salt spray)
- 1: Black anodized, jam nut (96hr salt spray)
- 2: Black anodized coupling ring (96hr salt spray)

### INTERFACIAL SEAL VARIATION

- Blank: Standard version, NBR
- 03: O-ring and seal gasket is silicone rubber
- 04: O-ring and seal gasket is Viton

## RTHP SERIES

### SERIES

- RT

### SHELL TYPE

- 0: Wall mount recep.
- 1: Inline receptacle
- 6: Cable plug
- 7: Jam nut recep. / rear panel mount

### SHELL SIZE

- 12, 14, 16, 20

### INSERT ARRANGEMENT

- See Page 7

### TYPE OF CONTACTS

- P: Pin contacts
- S: Socket contacts

### INSERT POLARIZATION

- N: Standard version

### APPLICATION

- Blank: Standard version (no o-ring)
- H: Standard version, water protection IP67

### DESIGN VARIATION

- Blank: Standard version
- EC: End cap

### PLATING

- Blank: Standard is nickel plating (48hr salt spray)
- 1: Black anodized, jam nut (96hr salt spray)
- 2: Black anodized coupling ring (96hr salt spray)

### INTERFACIAL SEAL VARIATION

- Blank: Standard version, NBR
- 03: O-ring and seal gasket is silicone rubber
- 04: O-ring and seal gasket is Viton

### Detail

Mating Face View of Pin Inserts

The five positions (W, X, Y, Z and Normal) differ in degree of rotation for various sizes and arrangements.

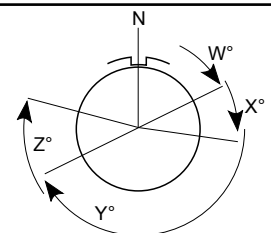

**Note:** Higher salt spray resistance (200/500h) upon request.

# Part Ordering Guide - RT Series Machined Contacts

SERIES	WIRE SIZE	CONTACT SIZE	CONTACT PACKAGING	DESIGN VARIATION	GROUNDING CONTACT	PLATING
*	*	*	*	*	*	*

## SERIES

- **MP:** Male; **MS:** Female

## WIRE SIZE

- **14:** 14AWG (2.5mm); **16:** 18-16AWG (.75-1.5mm); **20:** 22-20AWG (.34-.50mm);
- **24:** 26-24AWG (.14-.25mm); **28:** 30-28AWG (.05-.08mm); **8:** 10-8AWG (6-10mm)

## CONTACT SIZE

- **M:** Size 16; **W:** Size 20; **A:** Size 8 Power Contact

## CONTACT PACKAGING

- **BP:** Bulk Pack only

## DESIGN VARIATION

- **23:** Crimp Barrel; **12E0xx:** PCB tail, for RT00( wall mouting receptacle) **xx** is outer length of PCB tail; **12E7xx:** PCB tail, for RT07( Jam Nut Receptacle) **xx** is outer length of PCB tail; **RS8:** Radsok 3.6mm, crimp barrel

## GROUNDING CONTACT

- **GE1:** For Male GND contacts (1 mm longer) add **GE1** to the part number (ex: MP16M23GE1G15); **GE1:** For Female GND contacts (1.5 mm longer) add **GE1** to the p/n (ex: MS16M23GE1G15); **GE7:** For Female Last Mate contacts (0.6 mm shorter) add **GE7** to the part number (ex: MS16M23GE7G15)

## PLATING

- **T:** Tin; **F:** Gold Flash; **G:** Gold Plate [Thickness: 10u"]; **G30:** Gold Plate [Thickness: 30u"]; **N:** Nickel; **S:** Plating Silver (5um)



Contact Size	Wire Range		Plating	Male P/N	Female P/N
	AWG	mm			
8	10-8	6-10	Silver	MP8A23S	MS8A23S
16	14	2.5	Silver	MP14M23S	MS14M23S
			Gold Flash	MP14M23F	MS14M23F
			Gold 30u"	MP14M23G30	MS14M23G30
16	18-16	.75-1.5	Silver	MP16M23S	MS16M23S
			Gold Flash	MP16M23F	MS16M23F
			Gold 30u"	MP16M23G30	MS16M23G30
16	22-20	.34-.50	Silver	MP20M23S	MS20M23S
			Gold Flash	MP20M23F	MS20M23F
			Gold 30u"	MP20M23G30	MS20M23G30
16	26-24	.14-.25	Silver	MP24M23S	MS24M23S
			Gold Flash	MP24M23F	MS24M23F
			Gold 30u"	MP24M23G30	MS24M23G30
20	22-20	.34-.50	Silver	MP20W23S	MS20W23S
			Gold Flash	MP20W23F	MS20W23F
			Gold 30u"	MP20W23G30	MS20W23G30
20	30-28	.05-.08	Silver	MP28W23S	MS28W23S
			Gold Flash	MP28W23F	MS28W23F
			Gold 30u"	MP28W23G30	MS28W23G30



**RockSolid™**  
Connections  
Hyperbolic Contact  
Option

- Longer contact life
- Lower contact resistance
- Immunity to shock and vibration
- Low insertion and extraction forces
- Contact area extends 360° around pins





# Part Ordering Guide - RT Series Stamped & Formed Contacts

SERIES	WIRE SIZE AWG CRIMP	CONTACT SIZE	CONTACT PACKAGING	DESIGN VARIATION	PLATING
*	*	*	*	*	*

## SERIES

- **SP:** Male; **SS:** Female

## WIRE SIZE

- **2.5mm:** 2.5mm; **16:** 18-16AWG (.75-1.5mm); **20:** 22-20AWG (.34-.50mm); **24:** 26-24AWG (.14-.25mm); **28:** 30-28AWG (.05-.08mm)

## CONTACT SIZE

- **M:** Size 16; **W:** Size 20; **A:** 2.5mm contact

## CONTACT PACKAGING

- **Blank:** 3,000 pc reel; **L:** Loose Piece

## DESIGN VARIATION

- **1:** Crimp type

## PLATING

- **T:** Tin; **F:** Gold Flash; **G:** Gold Plate [Thickness: 10u"]; **G30:** Gold Plate [Thickness: 30u"]; **N:** Nickel; **S:** Silver



Contact Size	Wire Range		Plating	Male P/N	Female P/N
	AWG	mm			
2.5mm	NA	2.5	Tin	SP12A1T	SS12A1T
16	14	2.5	Gold Flash	SP14M1F	SS14M1F
			Gold 10u"	SP14M1G10	SS14M1G10
			Gold 30u"	SP14M1G30	SS14M1G30
16	18-16	.75-1.5	Gold Flash	SP16M1F	SS16M1F
			Gold 10u"	SP16M1G10	SS16M1G10
			Gold 30u"	SP16M1G30	SS16M1G30
16	22-20	.34-.50	Gold Flash	SP20M1F	SS20M1F
			Gold 10u"	SP20M1G10	SS20M1G10
			Gold 30u"	SP20M1G30	SS20M1G30
16	26-24	.14-.25	Gold Flash	SP24M1F	SS24M1F
			Gold 10u"	SP24M1G10	SS24M1G10
			Gold 30u"	SP24M1G30	SS24M1G30
20	22-20	.34-.50	Gold Flash	SP20W1F	SS20W1F
			Gold 10u"	SP20W1G10	SS20W1G10
			Gold 30u"	SP20W1G30	SS20W1G30
20	26-24	.14-.25	Gold Flash	SP24W1F	SS24W1F
			Gold 10u"	SP24W1G10	SS24W1G10
			Gold 30u"	SP24W1G30	SS24W1G30

# RADSOK® Technical Information

## High Reliability

Unique RADSOK® design and construction technology create an electrical contact interface that exceeds typical interconnect requirements. Applications in Aerospace, Medical, Industrial, Automotive, Mining, Offshore and other harsh environments depend on high reliability of the Amphenol RADSOK® technology.

## Low Contact Engagement/Separation Forces

The hyperbolic lamella socket contact construction distributes normal forces over a high percentage of the mating surface. This creates a smooth, even engagement effort. This force distribution also contributes to excellent performance in vibration applications with resistance to typical fretting corrosion.

## Low Contact Resistance

The large interface between the socket lamella and pin surface result in very low contact resistance, enabling the RADSOK® contacts' high current ratings compared to traditional power contact designs.

## High Mating Cycle Durability

RADSOK® contacts with typical silver plating finishes have demonstrated survival of 20,000 mating cycles. Specialized plating and contact lubricants can extend cycle life to 200,000 mating or higher. Even with continuous exposure to harsh environmental abuse (salt, sand and high humidity), RADSOK® contacts have been tested to maintain low contact resistance beyond 10,000 mating cycles.



RTHP RADSOK®	3.6mm	6mm	8mm
Current (DIN EN 60512)	115A (23°C) 107A (40°C) 86A (80°C) 56A (120°C)	155A (23°C) 148A (40°C) 116A (80°C) 77A (120°C)	240A (23°C) 235A (40°C) 185A (80°C) 120A (120°C)
Contact Resistance	= 0.15mΩ	= 0.11mΩ	= 0.08mΩ
Mating Force	= 10N	= 20N	= 50N
m	1.5g	5.6g	14.5g
l	13.2mm	21.9mm	25.7mm
di	3.6mm	6mm	8mm
da	6mm	9.5mm	13.5mm
Plating	Grid: Silver Sleeve: Silver	Grid: Silver Sleeve: Tinned	Grid: Silver Sleeve: Tinned

**Note:** The given electrical values correspond to a single contact. With the addition of a housing, an increased number of poles or other modifications, the values must be adjusted downwards accordingly.

# Part Ordering Guide - RTHP Series Machined Contacts

SERIES	WIRE SIZE	CONTACT SIZE	CONTACT PACKAGING	DESIGN VARIATION	PLATING
*	*	*	*	*	*

**SERIES**

- **HP:** Male; **HS:** Female

**WIRE SIZE**

- **10:** 8-10mm<sup>2</sup>; **16:** 13-16mm<sup>2</sup>; **25:** 20-25mm<sup>2</sup>; **35:** 30-35mm<sup>2</sup>; **50:** 40-50mm<sup>2</sup>; **75:** 70-75mm<sup>2</sup>

**CONTACT SIZE**

- **A:** 3.6mm; **B:** 6mm; **C:** 8mm; **D:** 10mm

**CONTACT PACKAGING**

- **BP:** Bulk Pack Only

**DESIGN VARIATION**

- **C:** Crimp Barrel; **P:** PCB Tail; **S:** Screw Tail; **W:** Soldier Tail; **H:** Flat Hole Tail

**PLATING**

- **T:** Tin; **F:** Gold Flash; **G:** Gold Plate [Thickness: 10u"]; **G30:** Gold Plate [Thickness: 30u"]; **N:** Nickel; **S:** Plating Silver (5um)



Contact Size	Wire Range	Plating	Male P/N	Female P/N	Type
3.6mm	8-10mm	Silver	HP10ACS	HS10ACS	Crimp
			HP10ASS	HS10ASS	Screwtail
			HP10AHS	HS10AHS	Flathole Tail
6mm	20-25mm	Silver	HP25BCS	HS25BCS	Crimp
			HP25BSS	HS25BSS	Screwtail
			HP25BHS	HS25BHS	Flathole Tail
8mm	30-35mm	Silver	HP35CCS	HS35CCS	Crimp
			HP35CSS	HS35CSS	Screwtail
			HP35CHS	HS35CHS	Flathole Tail
10mm	40-50mm	Silver	HP50DCS	HS50DCS	Crimp
			HP50DSS	HS50DSS	Screwtail
			HP50DHS	HS50DHS	Flathole Tail

Consult Factory for additional Touch Proof options.

## Typical Product Picture and Installation Dimension - RTHP Series







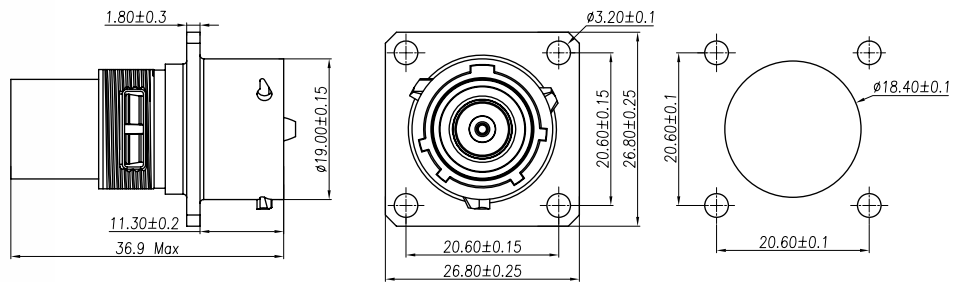

To be used within HV and EV when enduring large current and high voltage

Wall Mounting Receptacle for Crimp Barrel

Part Number: RTHP0121PNH-16C

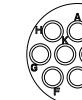
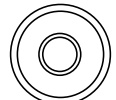
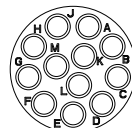
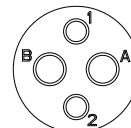
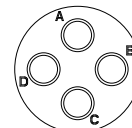
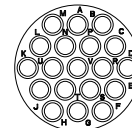

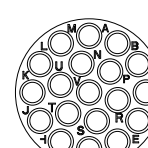
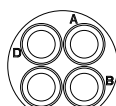
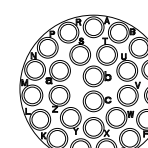
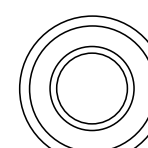
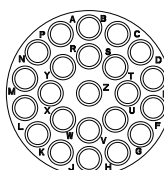
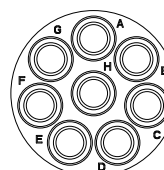
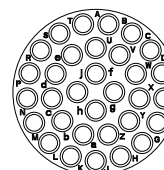
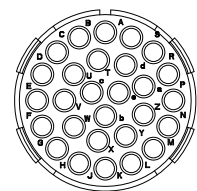
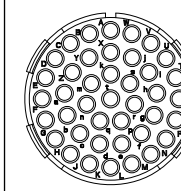
# Insert Configuration

RTO					RTHP Radsok®
#16 Contacts (1.6mm) 13A/250V	VDE Versions Mixed Power/Signal	Contacts (2.5mm)	#20 Contacts (1.0mm) 5A/150V <b>(1)</b> 7.5A/150V <b>(2)</b>	Single Pin Power	
<b>Note:</b> Specific to RTO, <b>(1)</b> refers to Stamped and Formed contacts; <b>(2)</b> refers to Machined contacts.					
Shell 10	 10-4	 10-2 2x#16(13A)/2X#20(5A) 350V AC/DC	N/A	 10-6	N/A
Shell 12	 12-3	N/A	N/A	 12-10	 12-1 1x3.6mm (86A) 600V AC/DC
Shell 14	 14-12 1x3.6mm	 14-2 2x2.5(23A)/2x#16(13A) 350V AC/DC	 14-4 (23A) 350V AC/DC	 14-19	 14-1 1x6mm (116A) 600V AC/DC
Shell 16	 16-19	 16-4 4x $\phi$ 3.6(46A) 400 AC/DC	N/A	 16-26	 16-1 1x8mm (185A) 600V AC/DC
Shell 18	 18-23	N/A	 18-8 (23A) 375V AC/DC	 18-32	N/A
Shell 20	 20-28	N/A	N/A	 20-41	 20-1 1x10mm (342A) 600V AC/DC

All dimensions are in mm. Face Views are not actual size and are only meant as a representation.

## Box and Wall Mounts

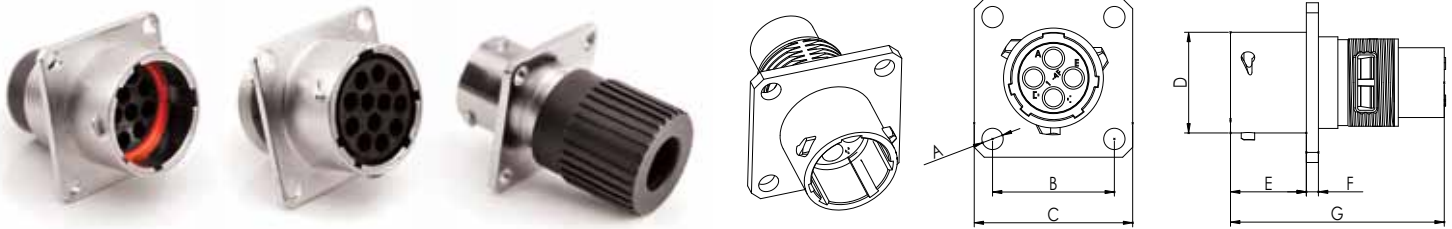

	A	B	C	D	E	F	G	G + End Cap Male	G + End Cap Female
Shell 10	3.20	18.30	23.80	15.00	11.30	1.80	31.85	40.65	32.70
Shell 12	3.20	20.62	26.20	19.00	11.30	1.80	31.85		
Shell 14	3.20	23.00	28.60	22.20	11.30	1.80	31.85		
Shell 16	3.20	24.60	31.00	25.30	11.30	1.80	31.85		
Shell 18	3.20	26.95	33.30	28.55	11.30	1.80	31.85		
Shell 20	3.20	29.50	36.50	31.70	14.55	2.40	33.65		

## Straight Plugs

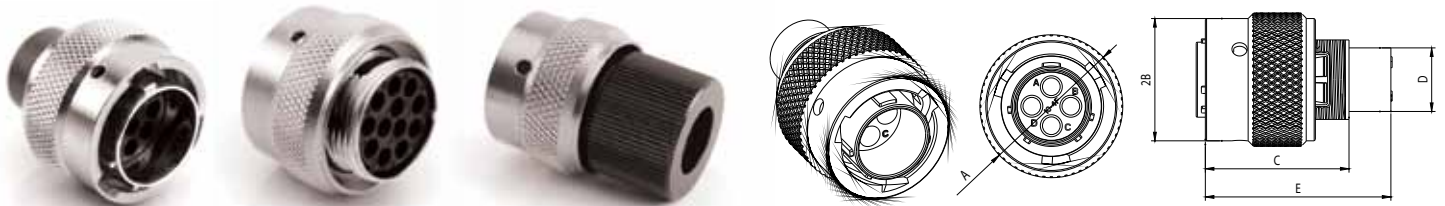

	A	B	C	D	E	H + End Cap Male	H + End Cap Female
Shell 10	21.80	20.00	23.50	10.40	30.35	40.65	32.70
Shell 12	26.10	23.60	23.50	-	30.35		
Shell 14	29.30	26.80	25.32	16.65	32.17		
Shell 16	32.45	30.00	23.50	19.50	30.35		
Shell 18	35.25	33.30	23.50	21.90	30.45		
Shell 20	38.55	36.55	25.80	25.20	30.65		

## Jam Nut Receptacle



	A	B	C	D	E	F	G	G + End Cap Male	G + End Cap Female
Shell 10	22.20	27.00	16.23	15.00	2.20	19.30	33.00	40.70	40.70
Shell 12	20.50	27.00	31.75	19.00	2.20	19.30	33.00		
Shell 14	23.60	30.20	34.90	22.20	2.20	19.30	33.00		
Shell 16	26.85	33.30	38.10	25.30	3.70	19.30	33.30		
Shell 18	29.86	36.50	41.30	28.55	2.50	19.30	33.00		
Shell 20	33.95	39.70	46.10	31.70	3.60	24.70	38.55		

## Cord Grips

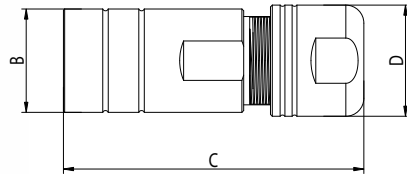

EMC Grounding Ring included

	Amphenol P/N	Cable Range	A (Thread)	B	C
Shell 10	RTOL-10CG-S1	3 to 6.5	9/16-24 UNEF	50	18.50
	RTOL-10CG-S2	5 to 8.5			
Shell 12	RTOL-12CG-S1	6 to 10.5	11/16-24 UNEF	54	23.00
	RTOL-12CG-S2	8 to 12.5			
Shell 14	RTOL-14CG-S1	6 to 10.5	13/16-20 UNEF	54	23.00
	RTOL-14CG-S2	8 to 12.5			
Shell 16	RTOL-16CG-S1	9.5 to 14.5	15/16-20 UNEF	60	26.50
	RTOL-16CG-S2	13.5 to 18			
Shell 18	RTOL-18CG-S1	9.5 to 14.5	1" 1/16-18 UNEF	60	28.20
	RTOL-18CG-S2	13.5 to 18			
Shell 20	RTOL-20CG-S1	16.5 to 22	1" 3/16-18 UNEF	63.5	33
	RTOL-20CG-S2	21.5 to 24			

All dimensions are in mm.

## Metal Cable Clamp Cord Grip

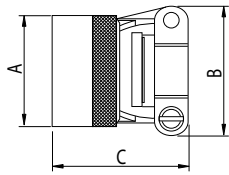

	Amphenol P/N	Max. Cable Diam.	A (Thread)	B	C
Shell 10	RT10SR	5.0	9/16-24 UNEF	21.6	31.0
Shell 12	RT12SR	8.2	11/16-24 UNEF	25.0	31.5
Shell 14	RT14SR	10.0	13/16-20 UNEF	27.4	34.0
Shell 16	RT16SR	13.0	15/16-20 UNEF	29.4	
Shell 18	RT18SR	16.0	1" 1/16-18 UNEF	35.2	31.4
Shell 20	RT20SR	21.0	1" 3/16-18 UNEF	37.6	32.0

**Metal Cable Clamp Cord Grip Plating Options Example:** RT10SR( ); RT10SR1; RT10SR2

( ): Standard is nickel plating (48hr salt spray)

1: Black anodized (96hr salt spray)

2: Black anodized (96hr salt spray)





## Wall Mounted Receptacle for Flat Hole Tail

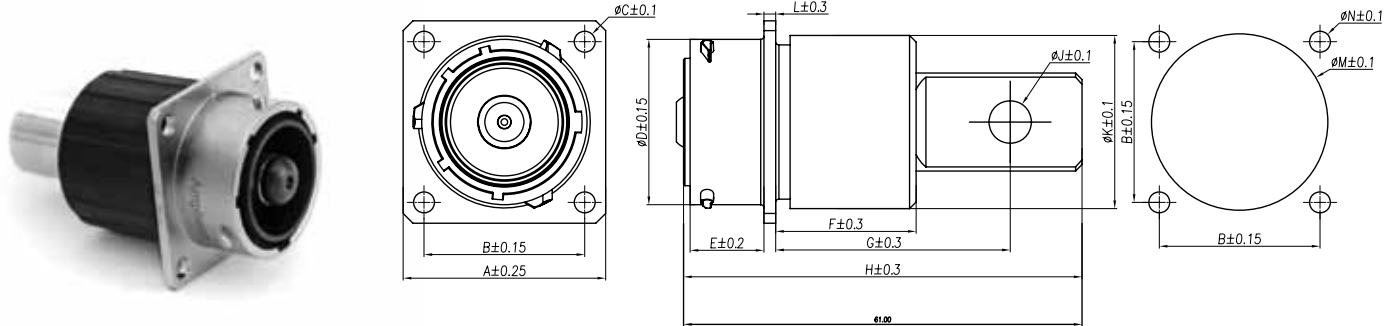

Amphenol P/N		A	B	ΦC	ΦD	E	F	G	H	J	K	L	ΦN	ΦM
Shell 12	RTHP0121PN-H1	26.8	20.6	3.2	19.0	11.35	19.6	34.0	55.1	5.5	21.8	1.8	3.2	22.5
Shell 14	RTHP0141PN-H1	23.0	28.6		22.2		17.2	28.5	53.1	5.5	23.9			24.5
Shell 16	RTHP0161PN-H1	24.6	31.0		25.3		21.5	35.9	61.0	6.5	26.5			27.0
Shell 20	RTHP0201PN-H1	29.4	26.5	4.2	31.7	14.55	22.2	40.1	72.0	8.5	33.5	2.4	4.2	34.0

## Straight Cable Plug with Cord Grip Solutions

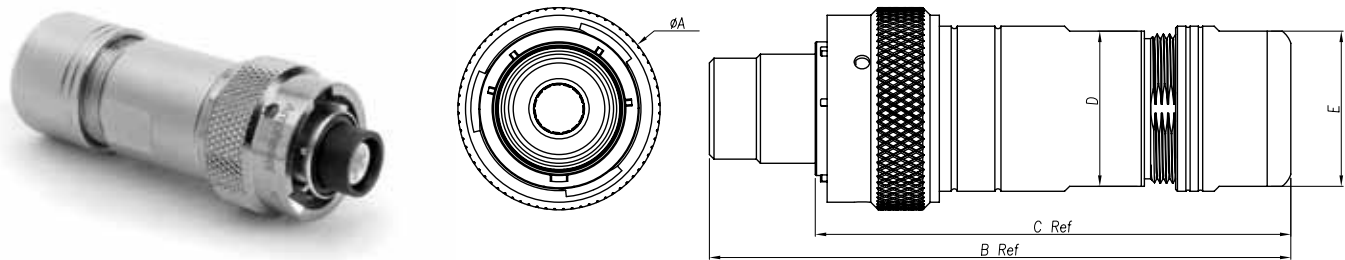

Amphenol P/N		A	B	C	D	E	Wire size	Cable max.
Shell 12	RTHP6121SNH-16S2	26.1	79.3	73.3	19.9	21.9	13-16 mm <sup>2</sup>	12.5 mm
Shell 14	RTHP6141SNH-25S2	29.3	86.4	72.3	19.9	21.9	20-25 mm <sup>2</sup>	12.5 mm
Shell 16	RTHP6161SNH-35S2	32.5	93.3	76.3	24.9	24.9	30-35 mm <sup>2</sup>	17.5 mm
Shell 20	RTHP6201SNH-70S2	38.6	100.9	80.8	28.9	28.9	70-75 mm <sup>2</sup>	20.0 mm

All dimensions are in mm.



## Straight Cable Plug with End Cap

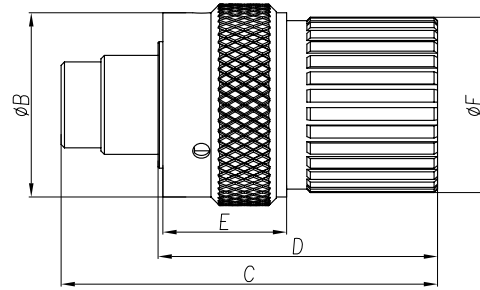
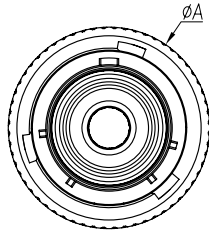

	Amphenol P/N	A	B	C	D	E	$\phi F$	Wire size	Cable max.
Shell 12	RTHP6121SNH-16EC	26.1	23.6	38.7	32.7	18.0	21.8	13-16 mm <sup>2</sup>	12.5 mm
Shell 14	RTHP6141SNH-25EC	29.3	26.8	54.8	40.7		25.5	20-25 mm <sup>2</sup>	12.5 mm
Shell 16	RTHP6161SNH-35EC	32.5	30.0	57.7	40.7		27.5	30-35 mm <sup>2</sup>	17.5 mm
Shell 20	RTHP6201SNH-70EC	38.6	36.6	62.7	42.7	19.0	34.5	70-75 mm <sup>2</sup>	20.0 mm

## Straight Cable Plug with 90° Cord Grip Solutions

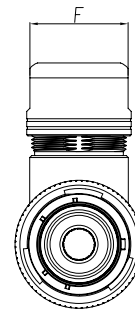
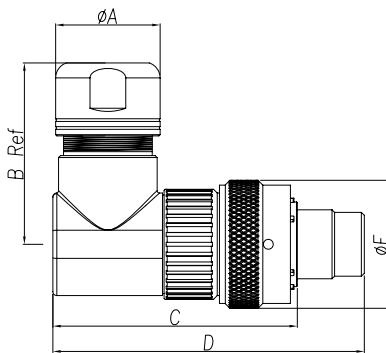

	Amphenol P/N	A	B	C	D	$\phi E$	$\phi F$	Wire size	Cable max.
Shell 12	RTHP6121SNH-16BS2	23.0	43.0	58.7	64.7	26.1	21.9	13-16 mm <sup>2</sup>	12.5 mm
Shell 14	RTHP6141SNH-25BS2	26.5	46.0	62.0	76.1	29.3	24.9	20-25 mm <sup>2</sup>	12.5 mm
Shell 16	RTHP6161SNH-35BS2	26.5	46.0	62.0	79.0	29.3	24.9	30-35 mm <sup>2</sup>	17.5 mm
Shell 20	RTHP6201SNH-70BS2	31.0	54.3	75.0	95.0	26.6	29.0	70-75 mm <sup>2</sup>	20.0 mm

## Accessories & Tooling

### Dust Caps

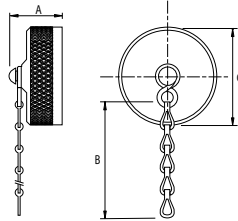

### Sealing Plugs



	Amphenol P/N	A max.	B	C max.
Shell 10	RT010DCG	21.8	42.00	30.20
Shell 12	RT012DCG	24.6		
Shell 14	RT014DCG	27.8		
Shell 16	RT016DCG	31.0		
Shell 18	RT018DCG	35.3		
Shell 20	RT020DCG	38.6		

	Amphenol P/N	mm
16AWG	CA-4016-59	1.5
20AWG	CA-4020-59	0.5

### Stamp Contact Tool

(Stamped and Formed Contacts)



	Amphenol P/N
16AWG	MFX-3954
20AWG	MFX-3958
2.5mm	MFX-3962

### Universal Hand Crimp Tool

(Machined Contacts)



	Amphenol P/N
	MFX-3959

### Contact Extraction Tool



	Amphenol P/N
16AWG	QXRT16
20AWG	QXRT20
2.5mm	QXRT12S

All dimensions are in mm.

## Crimp Die (Stamped and Formed Contacts)



Amphenol P/N	
16AWG	MFX-3957
20AWG	MFX-3964
2.5mm	MFX-3965

## Pneumatic Crimp Tool (Machined Contacts)



Amphenol P/N
MFX-3960

## Gaskets

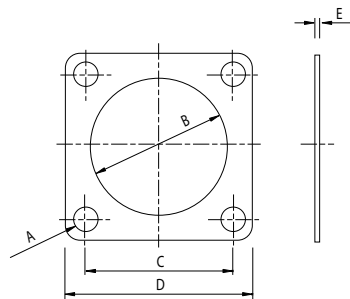

Amphenol P/N		$\text{ØA} \pm 0.1$	$\text{ØB} \pm 0.01$	$C \pm 0.25$	$D \pm 0.25$	$E \pm 0.2$
Shell 10	RTFD10B	3.3	15.9	18.3	23.8	0.8
Shell 12	RTFD12B		19.0	20.6	26.2	
Shell 14	RTFD14B		22.2	23.0	28.6	
Shell 16	RTFD16B		25.4	24.6	31.0	
Shell 18	RTFD18B		28.6	27.0	33.3	
Shell 20	RTFD20B		31.8	29.4	36.5	

Gasket material is NBR. For other options, please consult factory.

## NORTH AMERICA

### Amphenol Sine Systems MICHIGAN

44724 Morley Drive  
Clinton Township, MI 48036  
Toll-Free: 1-800-394-7732  
Fax: 1-586-465-1216  
Email: sine\_info@sineco.com

## EUROPE

### Amphenol Air LB

29, voie d' Yvois  
F-08110 Blagny, France  
Phone: 33-3-2422-7849  
Fax: 33-3-2422-7875  
Email: accueil@amphenol-airlb.fr

### Amphenol AIR LB GmbH

Am Kleinbahnhof 4  
Saarlouis D-66740, Germany  
Phone: 49-6831-981-00  
Fax: 49-6831-981-030  
Email: info@amphenol-airlb.de

### Amphenol BENELUX

Zadelmaker 121  
NL-2401PD Alphen aan den Rijn  
The Netherlands  
Phone: (31) 172 444903  
Fax: (31) 172 240254  
E-mail: info@amphenol-nl.com

### Amphenol CENTER EAST EUROPE, POLAND and AUSTRIA

Wiener Gasse 68  
2380 Perchtoldsdorf, Austria  
Phone: 43-699-10396071  
Fax: 43-699-40396071  
Email: c.czesch@amphenol-roe.eu

## ASIA

### Amphenol Sine Systems CHINA

2/F Building A5, Hua Feng Technology Park  
Guan Tian, Bei Huan Road, Shi Yan Street  
Bao An District, Shenzhen, China 518108  
Tel: 86-755-8173-8000 ext. 8098  
Fax: 86-755-8173-8180  
Email: fount.nee@amphenolpcd.com.cn

### Amphenol INTERCONNECT INDIA PRIVATE LTD

105 Bhosari Industrial Area  
Pune 411 026, India  
Phone: 91-20-712-0363/0463/0155  
Fax: 91-20-712-0581

## OTHER LOCATIONS

### Amphenol MEXICO

Prolongacion Reforma 61-6 B2  
Col. Paseo de las Lomas  
C.P. 01330 Mexico DF, Mexico  
Phone: 52-55-5258-9984  
Fax: 52-55-5081-6890  
Email: www.amphenolmexico.com

### Amphenol ARGENTINA

Avenida Callao 930  
2nd floor Office B Plaza  
C1023AAP Buenos Aires, Argentina  
Phone: 54-11-4815-6886  
Fax: 54-11-4814-5779

### Amphenol BRASIL LTDA

Rua Diogo Moreira, 132  
20 Andar, Rooms 2001-2-3  
CEP 05423-101  
Sao Paulo - SP, Brazil  
Phone: 55-11-3815-1003  
Fax: 55-11-3815-1629  
Email: vendas@amphenol.com.br

### Amphenol ESPANA

Edificio Burgosal, Oficina N 55  
C/Comunidad de Madrid, 35 bis  
Las Rozas (Madrid), 28230  
Phone: 34-91-6407302  
Mobile: 34-629054629  
Fax: 34-91-6407307  
Email: e.bendix@amphenol-roe.eu

### Amphenol ITALIA

Via Barbaiana 5  
20020 Lainate, Milano, Italy  
Phone: 39-02-932541  
Fax: 39-02-9325444  
Email: r.buscone@amphenol-roe.eu

### Amphenol NORDIC

Appelboms vag 2  
SE-18642 Vallentuna, Sweden  
Phone: 46-76-8418600  
Fax: 46-70-2203197  
Email: f.weden@amphenol-roe.eu

### Amphenol SOCAPEX

948, Promenade de l'Arve - BP 29  
74311 Thyez CEDEX, France  
Phone: 33(0)4-50-89-28-40  
Fax: 33(0)4-50-96-29-75  
Email: jocelyne.anthoine@amphenol-socapex.fr

### Amphenol DAESHIN

558, Songnae-2 Dong, SoSa-Gu  
Bucheon City, Gyeonggi-do, Korea 422-818  
Phone: 81-32-610-3800  
Fax: 81-32-673-2507  
Email: info@amphenol.co.kr

### Amphenol JAPAN

471-1, Deba, Ritto-city  
shiga 520-3041, Japan  
Phone: 81-77-553-8501  
Fax: 81-77-551-2200

### Amphenol SOUTH AFRICA

30 Impala Road  
2196 Sandton, Chislehurst  
South Africa  
Phone: 27-11-783-9517  
Fax: 27-11-783-9519  
Email: amphenol\_africa@csi.com

### Amphenol AUSTRALIA PTY LIMITED

2 Fiveways Blvd., Keysborough  
Melbourne, Victoria 3173 Australia  
Phone: 613-8796-8888  
Fax: 613-8796-8801

### Amphenol TURKEY

Ayazaga Mah. Meyden Sk. No. 28  
Beybi Giz Plaza, Kat. 26  
34396 Maslak/Istanbul, Turkey  
Phone: 90-212-335-2501  
Fax: 90-212-335-25-00

### Amphenol SWITZERLAND & SOUTH CENTER EUROPE

Switzerland, Slovenia, Serbia, Montenegro,  
Yugoslavia, Greece, Bulgaria  
948, Promenade de l'Arve - BP29  
74311 Thyez - France  
Phone: 33-4-50-89-28-00  
Fax: 33-4-50-96-29-75

### Amphenol TUCHEL GmbH

August-Haeusser-Strasse 10  
Heilbronn, 74080  
Germany  
Phone: 49(0)-7131-929-0  
Fax: 49(0)-7131-929-486  
Email: info@amphenol.de

### Amphenol LIMITED

Thanet Way, Whitstable  
Kent CT5 3JF, United Kingdom  
Phone: 44-1-227-773200  
Fax: 44-1-227-276571