



STD10NM50N STF10NM50N, STP10NM50N

N-channel 500 V, 0.53 Ω , 7 A DPAK, TO-220FP, TO-220
MDmesh™ II Power MOSFET

Features

Type	V _{DSS} (@T _{jmax})	R _{DS(on)} max	I _D
STD10NM50N	550 V	< 0.63 Ω	7 A
STF10NM50N			
STP10NM50N			

- 100% avalanche tested
- Low input capacitance and gate charge
- Low gate input resistance

Applications

- Switching applications

Description

These devices are N-channel Power MOSFETs developed using the second generation of MDmesh™ technology. This revolutionary Power MOSFET associates a vertical structure to the company's strip layout to yield one of the world's lowest on-resistance and gate charge. It is therefore suitable for the most demanding high efficiency converters.

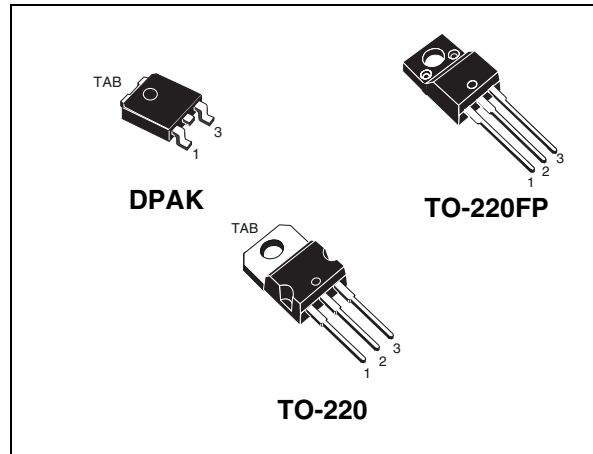

Figure 1. Internal schematic diagram

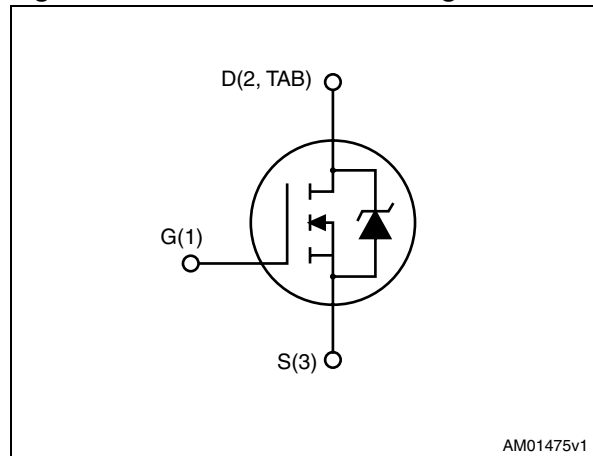

Table 1. Device summary

Order codes	Marking	Packages	Packaging
STD10NM50N	10NM50N	DPAK	Tape and reel
STF10NM50N		TO-220FP	Tube
STP10NM50N		TO-220	

Contents

1	Electrical ratings	3
2	Electrical characteristics	4
2.1	Electrical characteristics (curves)	6
3	Test circuits	9
4	Package mechanical data	10
5	Packaging mechanical data	15
6	Revision history	17

1 Electrical ratings

Table 2. Absolute maximum ratings

Symbol	Parameter	Value		Unit
		DPAK, TO-220	TO-220FP	
V_{DS}	Drain-source voltage	500		V
V_{GS}	Gate- source voltage	± 25		V
I_D	Drain current (continuous) at $T_C = 25\text{ °C}$	7	7 ⁽¹⁾	A
I_D	Drain current (continuous) at $T_C = 100\text{ °C}$	5	5 ⁽¹⁾	A
$I_{DM}^{(2)}$	Drain current (pulsed)	28	28 ⁽¹⁾	A
P_{TOT}	Total dissipation at $T_C = 25\text{ °C}$	70	25	W
V_{ISO}	Insulation withstand voltage (RMS) from all three leads to external heat sink ($t=1\text{ s}; T_C=25\text{ °C}$)		2500	V
$dv/dt^{(3)}$	Peak diode recovery voltage slope	15		V/ns
T_{stg}	Storage temperature	- 55 to 150		°C
T_j	Max. operating junction temperature	150		°C

- Limited by maximum junction temperature.
- Pulse width limited by safe operating area
- $I_{SD} \leq 7\text{ A}$, $di/dt \leq 400\text{ A}/\mu\text{s}$, $V_{DD} = 80\% V_{(BR)DSS}$, $V_{DSpeak} \leq V_{(BR)DSS}$

Table 3. Thermal data

Symbol	Parameter	Value			Unit
		DPAK	TO-220	TO-220FP	
$R_{thj-case}$	Thermal resistance junction-case max	1.79		5	°C/W
$R_{thj-pcb}^{(1)}$	Thermal resistance junction-pcb minimum footprint	50			°C/W
$R_{thj-amb}$	Thermal resistance junction-ambient max		62.5		°C/W
T_l	Maximum lead temperature for soldering purpose		300		°C

- When mounted on 1inch² FR-4 board, 2 oz Cu

Table 4. Avalanche characteristics

Symbol	Parameter	Value	Unit
I_{AR}	Avalanche current, repetitive or not-repetitive (pulse width limited by T_j Max)	2	A
E_{AS}	Single pulse avalanche energy (starting $T_j = 25\text{ °C}$, $I_D = I_{AR}$, $V_{DD} = 50\text{ V}$)	143	mJ

2 Electrical characteristics

($T_{CASE}=25^{\circ}C$ unless otherwise specified)

Table 5. On/off states

Symbol	Parameter	Test conditions	Min.	Typ.	Max.	Unit
$V_{(BR)DSS}$	Drain-source breakdown voltage ($V_{GS} = 0$)	$I_D = 1 \text{ mA}$	500			V
I_{DSS}	Zero gate voltage drain current ($V_{GS} = 0$)	$V_{DS} = 500 \text{ V}$ $V_{DS} = 500 \text{ V}, T_C = 125^{\circ}C$			1 100	μA μA
I_{GSS}	Gate-body leakage current ($V_{DS} = 0$)	$V_{GS} = \pm 25 \text{ V}$			0.1	μA
$V_{GS(th)}$	Gate threshold voltage	$V_{DS} = V_{GS}, I_D = 250 \mu\text{A}$	2	3	4	V
$R_{DS(on)}$	Static drain-source on resistance	$V_{GS} = 10 \text{ V}, I_D = 3.5 \text{ A}$		0.53	0.63	Ω

Table 6. Dynamic

Symbol	Parameter	Test conditions	Min.	Typ.	Max.	Unit
C_{iss}	Input capacitance	$V_{DS} = 50 \text{ V}, f = 1 \text{ MHz},$ $V_{GS} = 0$	-	450	-	pF
C_{oss}	Output capacitance			38		
C_{rss}	Reverse transfer capacitance			1.3		
$C_{oss \text{ eq.}}^{(1)}$	Equivalent output capacitance	$V_{GS} = 0, V_{DS} = 0 \text{ to } 400 \text{ V}$	-	167	-	pF
Q_g	Total gate charge	$V_{DD} = 400 \text{ V}, I_D = 7 \text{ A},$ $V_{GS} = 10 \text{ V},$ <i>(see Figure 18)</i>	-	17	-	nC
Q_{gs}	Gate-source charge			3.3		
Q_{gd}	Gate-drain charge			8.5		
R_g	Gate input resistance	$f=1 \text{ MHz}$ Gate DC Bias=0 Test signal level=20 mV open drain	-	4.7	-	Ω

1. $C_{oss \text{ eq.}}$ is defined as a constant equivalent capacitance giving the same charging time as C_{oss} when V^{DS} increases from 0 to 80% V_{DS} .

Table 7. Switching times

Symbol	Parameter	Test conditions	Min.	Typ.	Max.	Unit
$t_{d(on)}$	Turn-on delay time	$V_{DD} = 250\text{ V}$, $I_D = 3.5\text{ A}$ $R_G = 4.7\ \Omega$, $V_{GS} = 10\text{ V}$ (see Figure 17)	-	7.8	-	ns
t_r	Rise time		-	4.4	-	ns
$t_{d(off)}$	Turn-off delay time		-	7.8	-	ns
t_f	Fall time		-	12	-	ns

Table 8. Source drain diode

Symbol	Parameter	Test conditions	Min	Typ.	Max	Unit	
I_{SD}	Source-drain current		-		7	A	
$I_{SDM}^{(1)}$	Source-drain current (pulsed)				28	A	
$V_{SD}^{(2)}$	Forward on voltage	$I_{SD} = 7\text{ A}$, $V_{GS} = 0$	-		1.3	V	
t_{rr}	Reverse recovery time	$I_{SD} = 7\text{ A}$, $di/dt = 100\text{ A}/\mu\text{s}$ $V_{DD} = 60\text{ V}$ (see Figure 22)	-	177		ns	
Q_{rr}	Reverse recovery charge				1.4		μC
I_{RRM}	Reverse recovery current				16		A
t_{rr}	Reverse recovery time	$I_{SD} = 7\text{ A}$, $di/dt = 100\text{ A}/\mu\text{s}$ $V_{DD} = 60\text{ V}$, $T_j = 150\text{ }^\circ\text{C}$ (see Figure 22)	-	216		ns	
Q_{rr}	Reverse recovery charge				1.7		μC
I_{RRM}	Reverse recovery current				15.4		A

1. Pulse width limited by safe operating area
2. Pulsed: Pulse duration = 300 μs , duty cycle 1.5%

2.1 Electrical characteristics (curves)

Figure 2. Safe operating area for DPAK

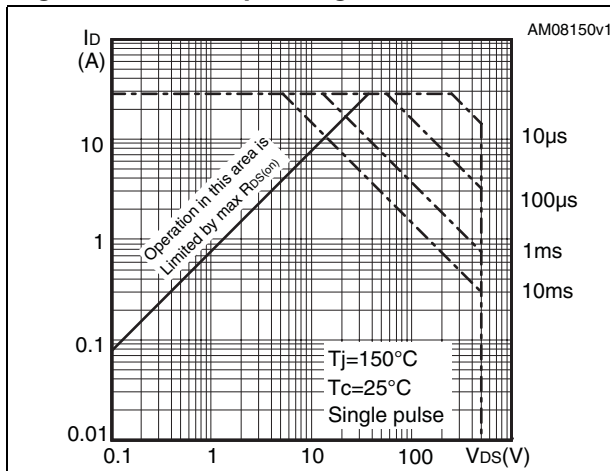

Figure 3. Thermal impedance for DPAK

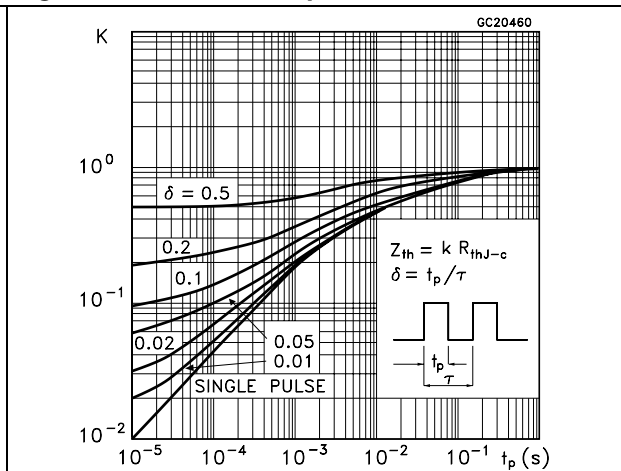

Figure 4. Safe operating area for TO-220FP

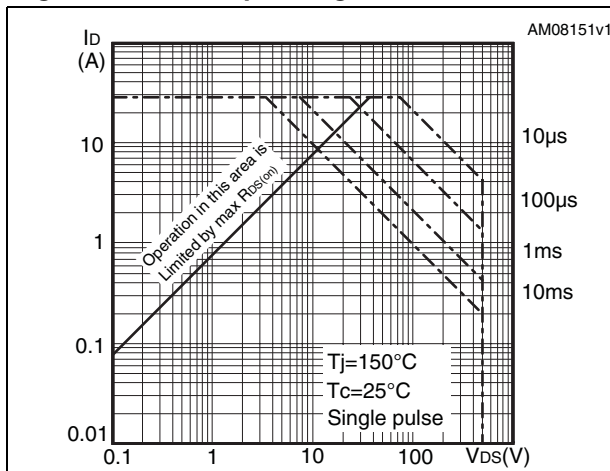

Figure 5. Thermal impedance for TO-220FP

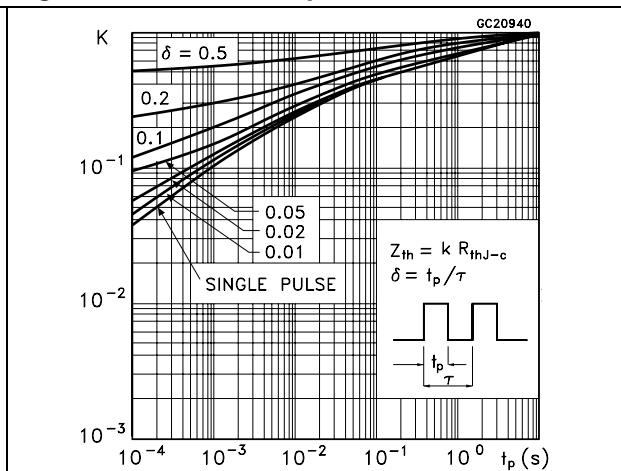

Figure 6. Safe operating area for TO-220

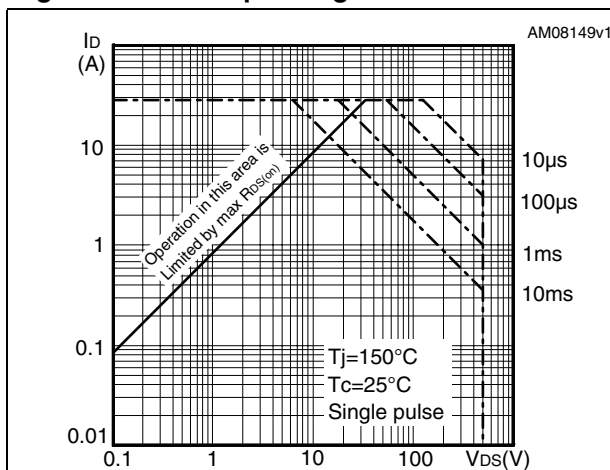

Figure 7. Thermal impedance for TO-220

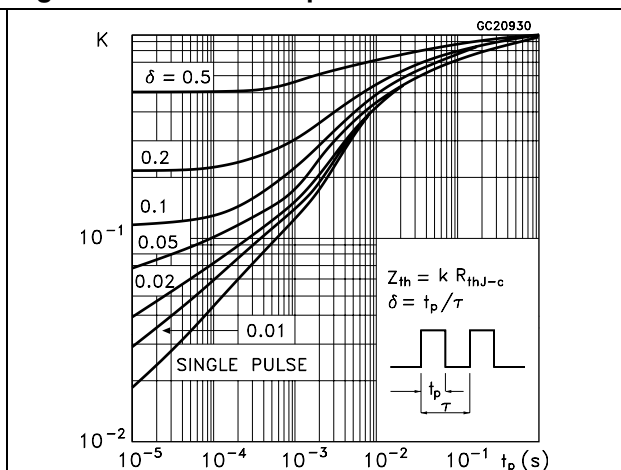

Figure 8. Output characteristics

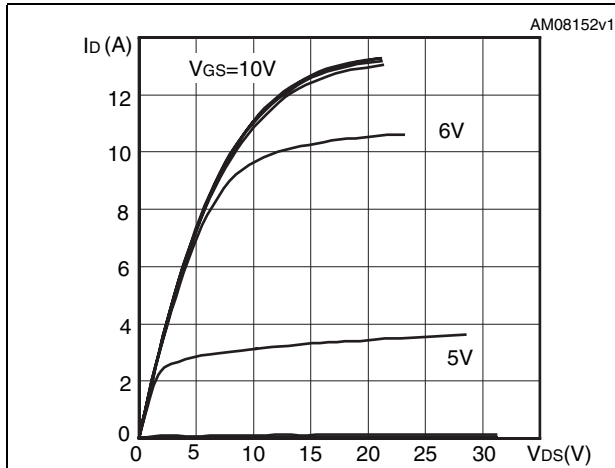

Figure 9. Transfer characteristics

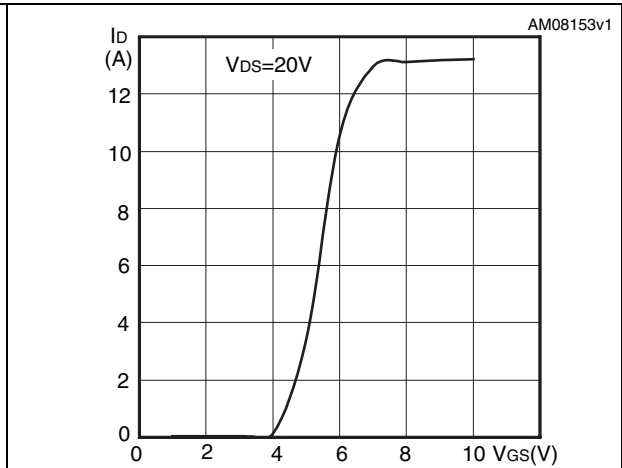

Figure 10. Gate charge vs gate-source voltage Figure 11. Static drain-source on resistance

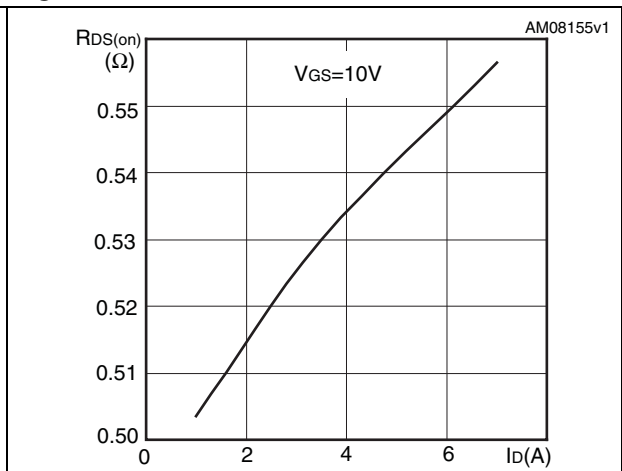
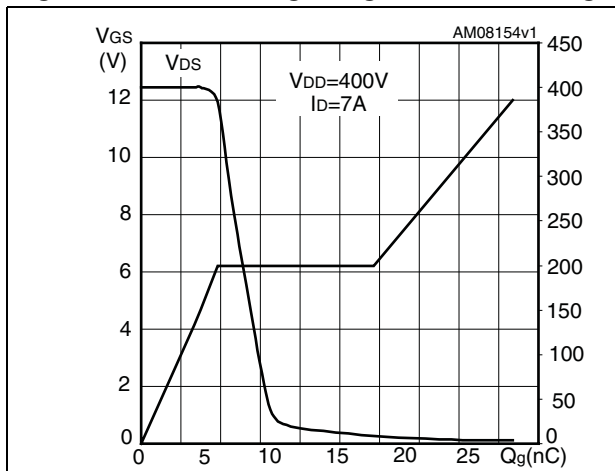

Figure 12. Capacitance variations

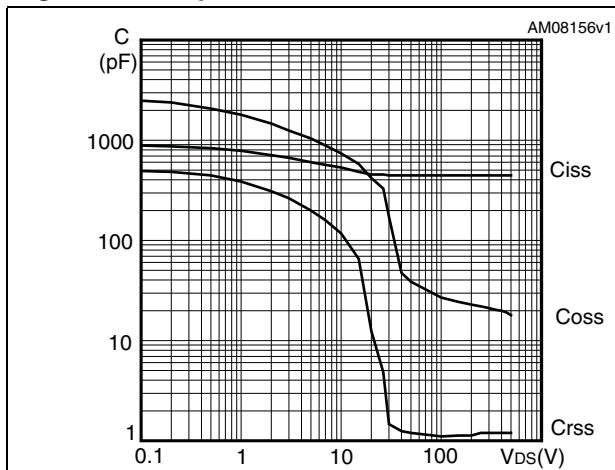

Figure 13. Output capacitance stored energy

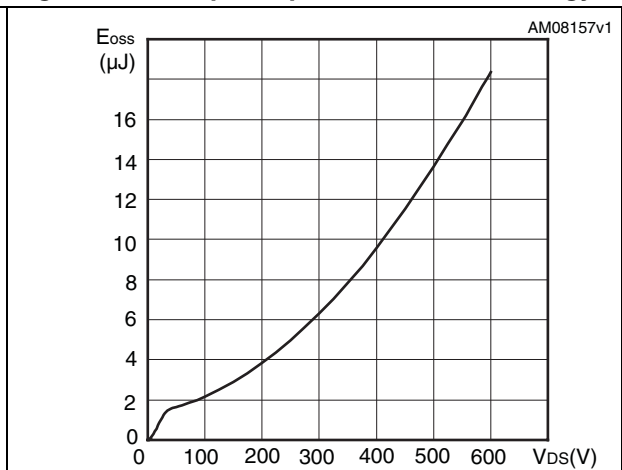

Figure 14. Normalized gate threshold voltage vs temperature

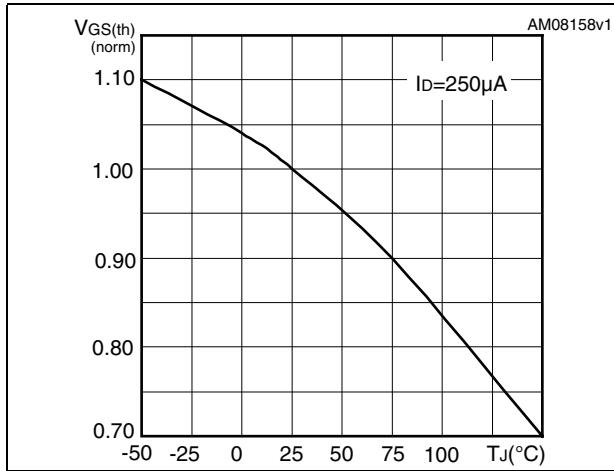

Figure 15. Normalized on resistance vs temperature

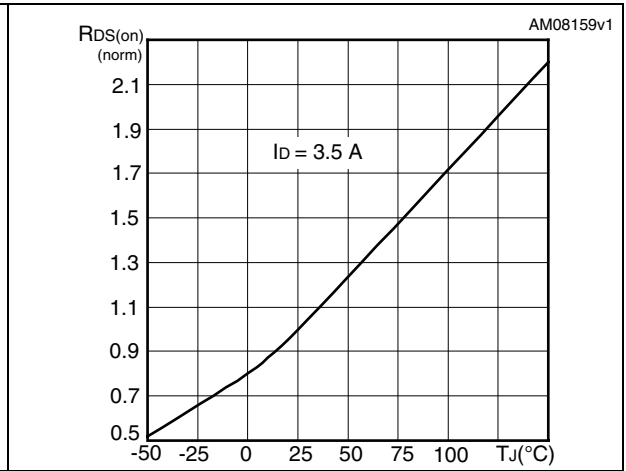
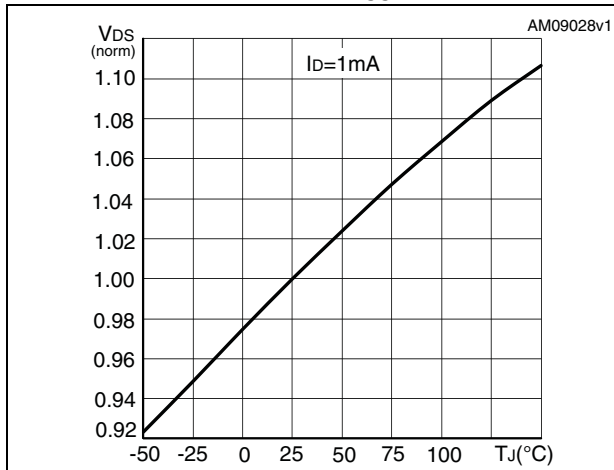

Figure 16. Normalized $B_{V_{DSS}}$ vs temperature



3 Test circuits

Figure 17. Switching times test circuit for resistive load



AM01468v1

Figure 18. Gate charge test circuit



AM01469v1

Figure 19. Test circuit for inductive load switching and diode recovery times



AM01470v1

Figure 20. Unclamped inductive load test circuit



AM01471v1

Figure 21. Unclamped inductive waveform

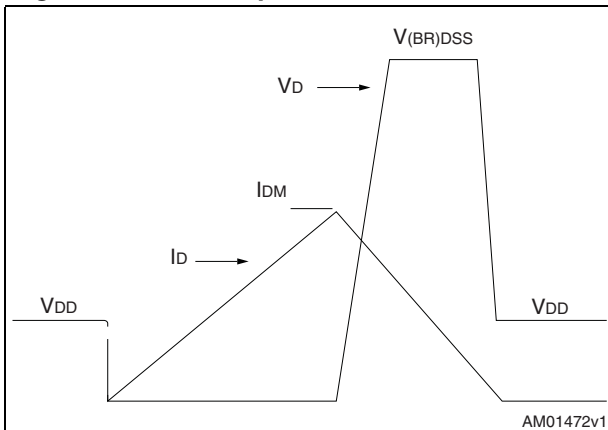

AM01472v1

Figure 22. Switching time waveform

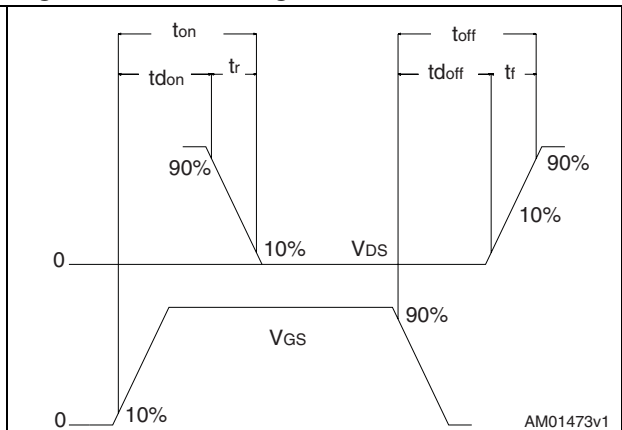

AM01473v1

4 Package mechanical data

In order to meet environmental requirements, ST offers these devices in different grades of ECOPACK[®] packages, depending on their level of environmental compliance. ECOPACK[®] specifications, grade definitions and product status are available at: www.st.com. ECOPACK is an ST trademark.

Table 9. DPAK (TO-252) mechanical data

Dim.	mm		
	Min.	Typ.	Max.
A	2.20		2.40
A1	0.90		1.10
A2	0.03		0.23
b	0.64		0.90
b4	5.20		5.40
c	0.45		0.60
c2	0.48		0.60
D	6.00		6.20
D1		5.10	
E	6.40		6.60
E1		4.70	
e		2.28	
e1	4.40		4.60
H	9.35		10.10
L	1		1.50
L1		2.80	
L2		0.80	
L4	0.60		1
R		0.20	
V2	0°		8°

Figure 23. DPAK (TO-252) drawing

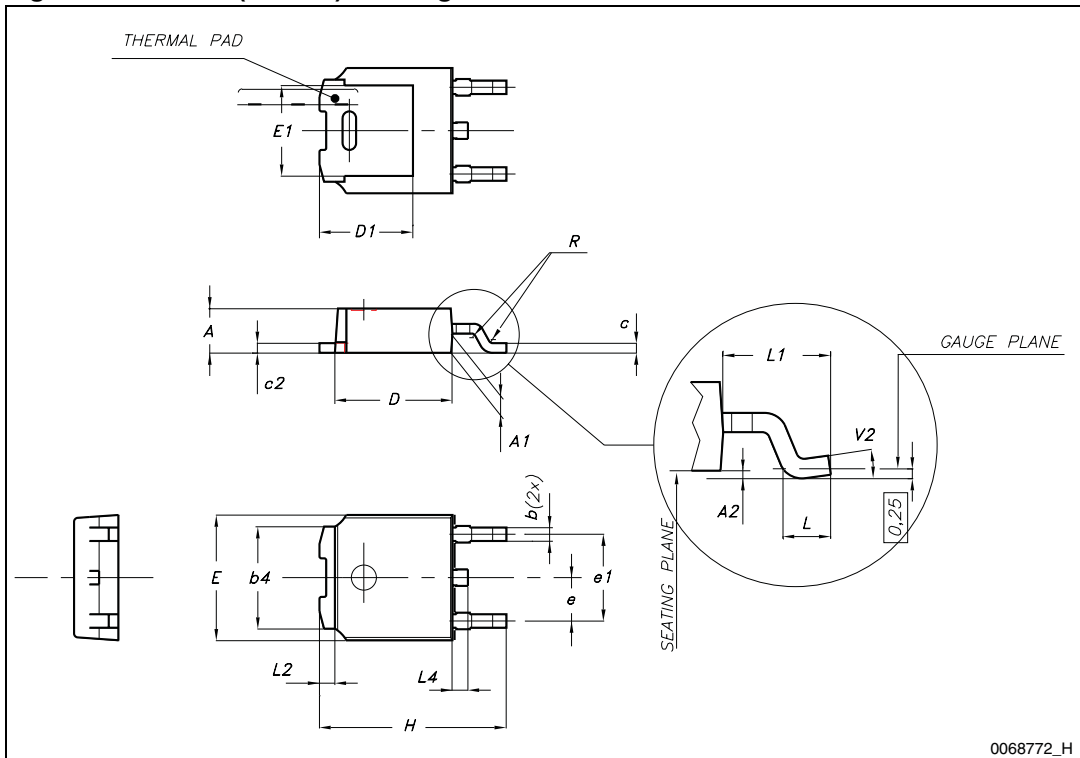
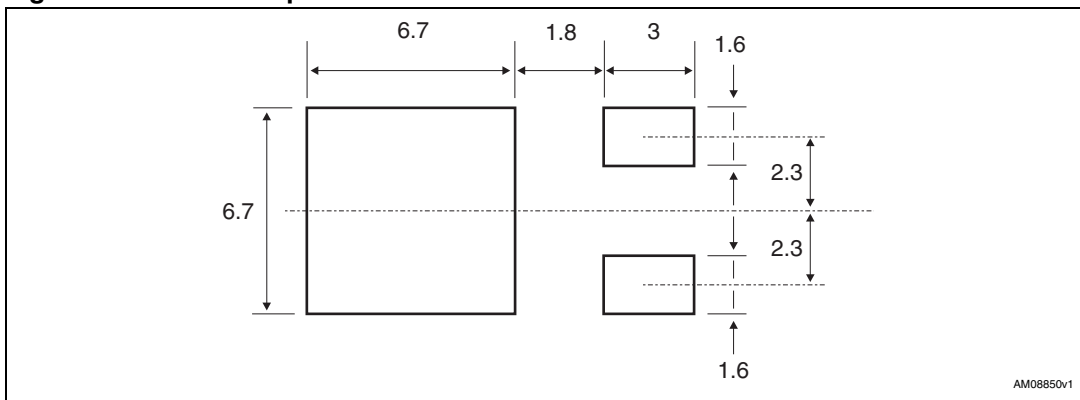

Figure 24. DPAK footprint^(a)



a. All dimension are in millimeters

Table 10. TO-220FP mechanical data

Dim.	mm		
	Min.	Typ.	Max.
A	4.4		4.6
B	2.5		2.7
D	2.5		2.75
E	0.45		0.7
F	0.75		1
F1	1.15		1.70
F2	1.15		1.70
G	4.95		5.2
G1	2.4		2.7
H	10		10.4
L2		16	
L3	28.6		30.6
L4	9.8		10.6
L5	2.9		3.6
L6	15.9		16.4
L7	9		9.3
Dia	3		3.2

Figure 25. TO-220FP drawing

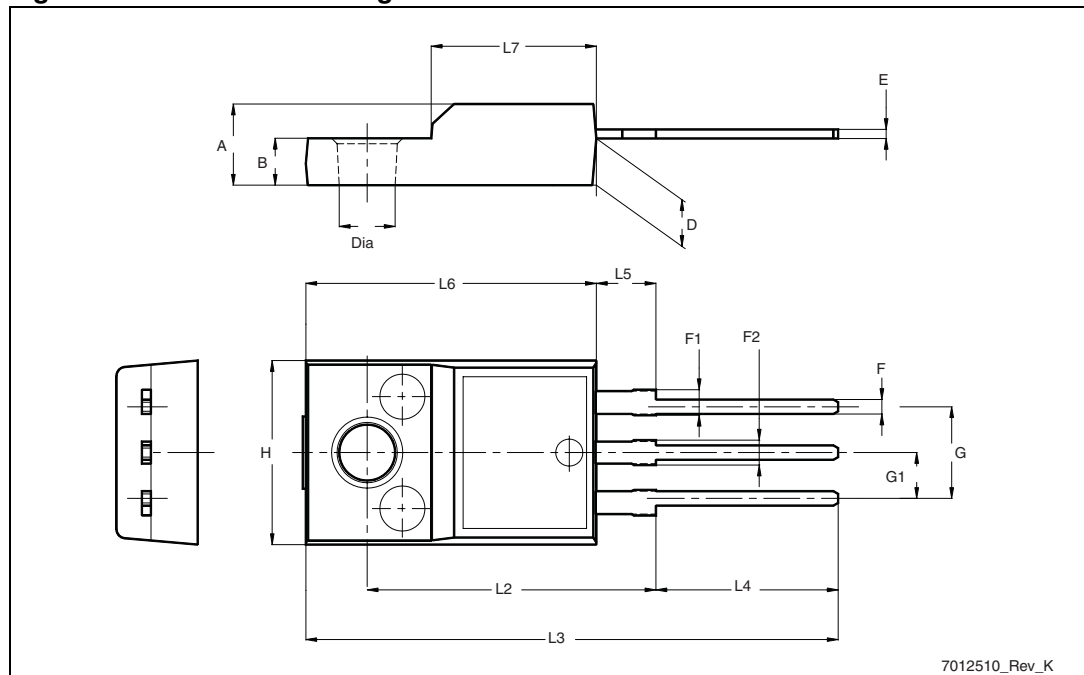
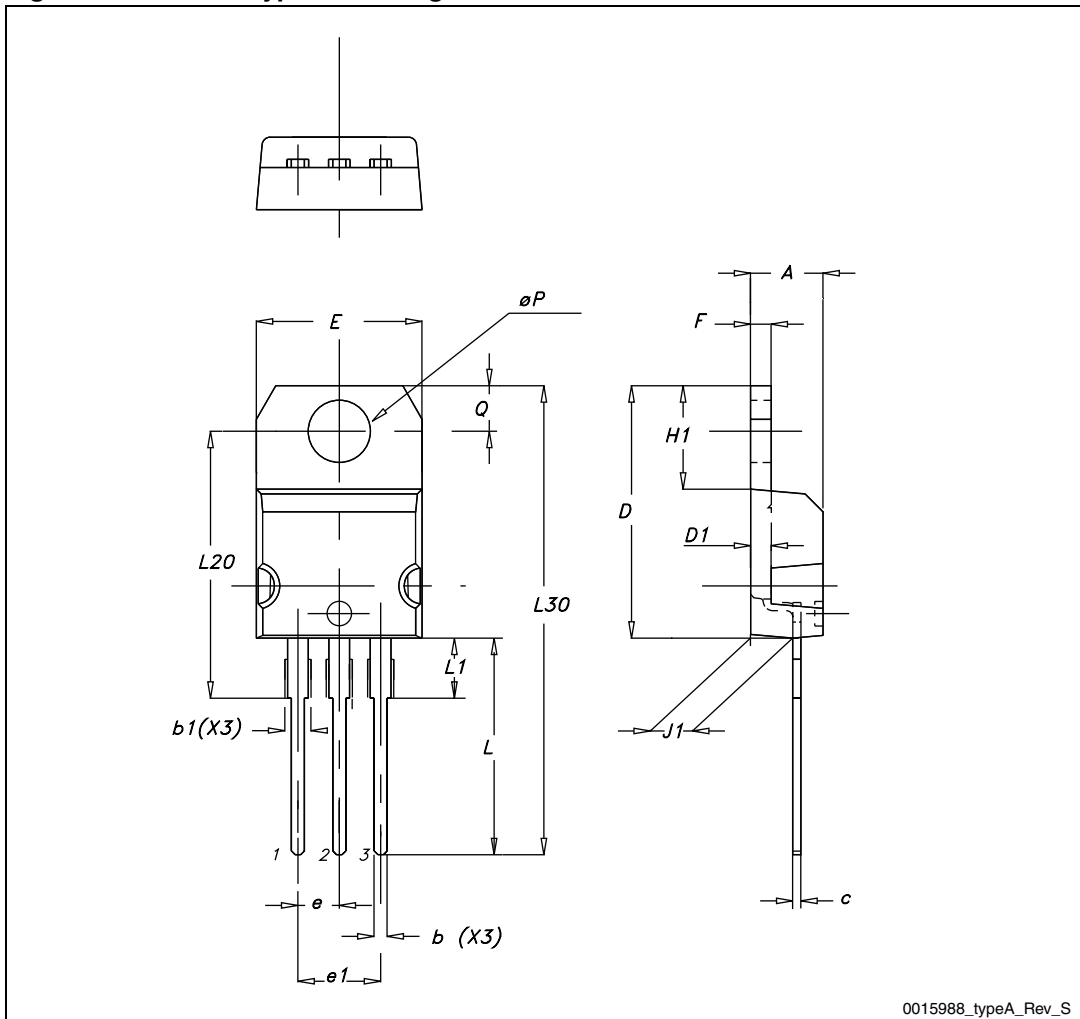

Table 11. TO-220 type A mechanical data

Dim.	mm		
	Min.	Typ.	Max.
A	4.40		4.60
b	0.61		0.88
b1	1.14		1.70
c	0.48		0.70
D	15.25		15.75
D1		1.27	
E	10		10.40
e	2.40		2.70
e1	4.95		5.15
F	1.23		1.32
H1	6.20		6.60
J1	2.40		2.72
L	13		14
L1	3.50		3.93
L20		16.40	
L30		28.90	
ØP	3.75		3.85
Q	2.65		2.95

Figure 26. TO-220 type A drawing



5 Packaging mechanical data

Table 12. DPAK (TO-252) tape and reel mechanical data

Tape			Reel		
Dim.	mm		Dim.	mm	
	Min.	Max.		Min.	Max.
A0	6.8	7	A		330
B0	10.4	10.6	B	1.5	
B1		12.1	C	12.8	13.2
D	1.5	1.6	D	20.2	
D1	1.5		G	16.4	18.4
E	1.65	1.85	N	50	
F	7.4	7.6	T		22.4
K0	2.55	2.75			
P0	3.9	4.1	Base qty.		2500
P1	7.9	8.1	Bulk qty.		2500
P2	1.9	2.1			
R	40				
T	0.25	0.35			
W	15.7	16.3			

Figure 27. Tape for DPAK (TO-252)

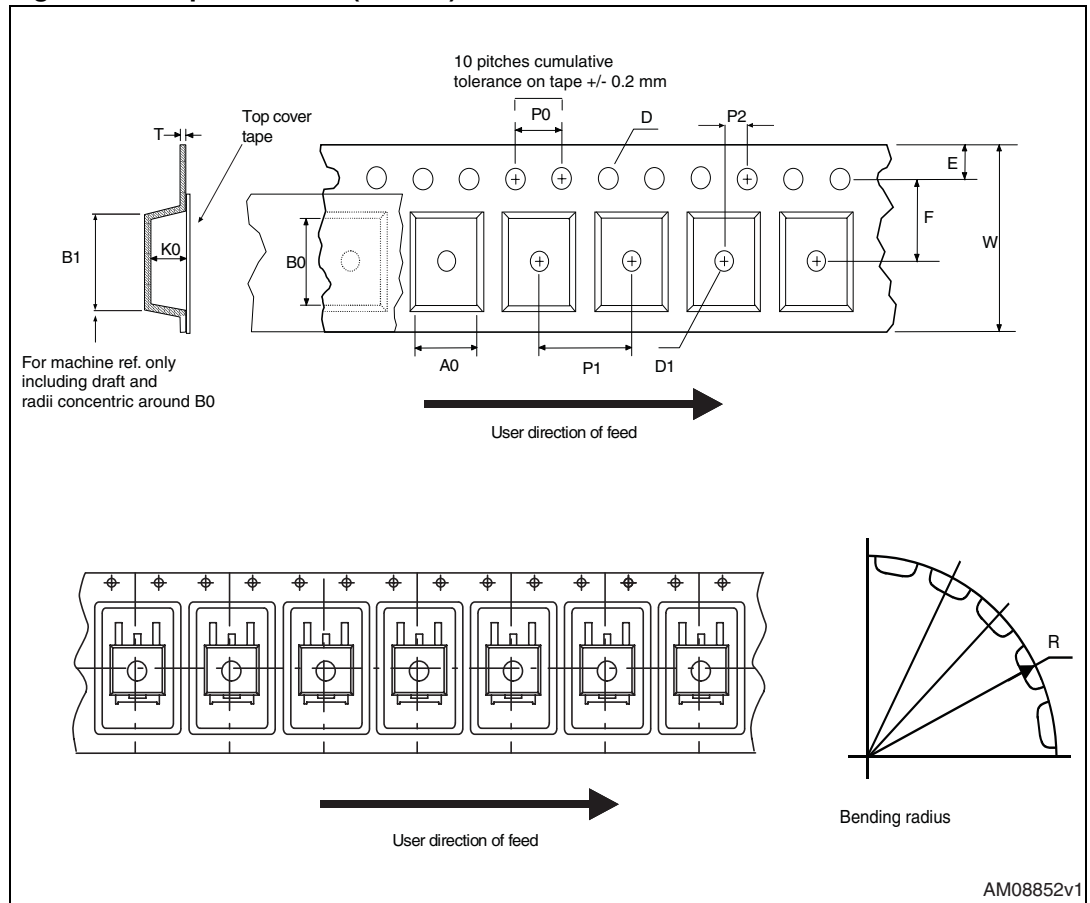
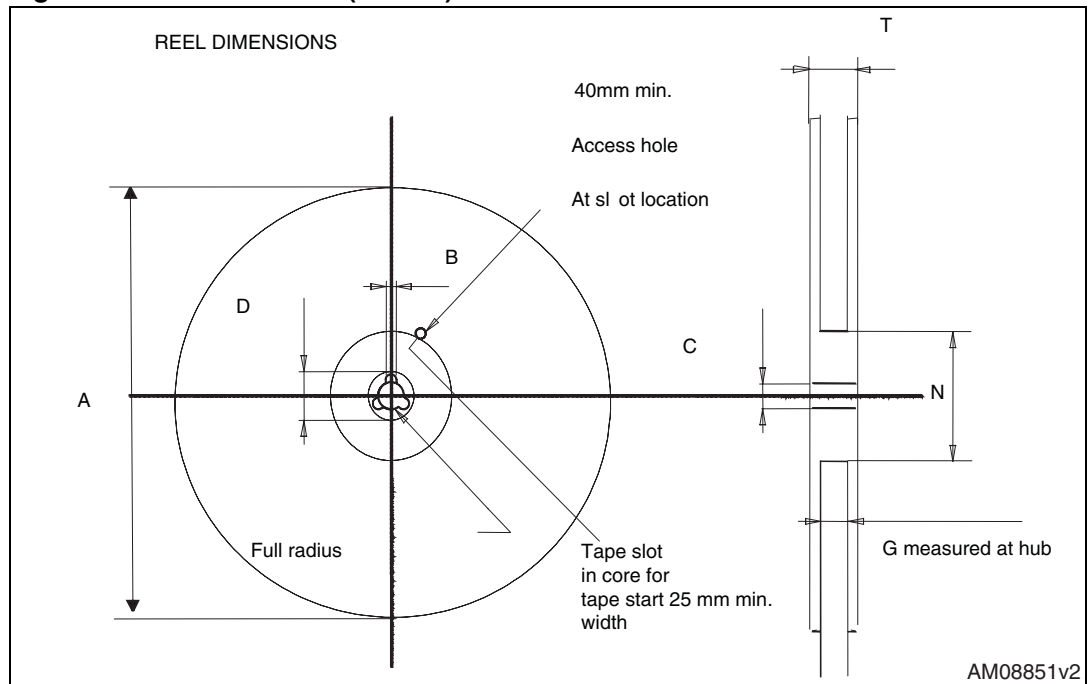

Figure 28. Reel for DPAK (TO-252)



6 Revision history

Table 13. Document revision history

Date	Revision	Changes
16-Dec-2009	1	First release.
08-Sep-2010	2	Document status promoted from preliminary data to datasheet.
26-Oct-2011	3	Updated V_{DSS} (@Tjmax) in cover page. Updated Section 4: Package mechanical data and Section 5: Packaging mechanical data . Minor text changes.

Please Read Carefully:

Information in this document is provided solely in connection with ST products. STMicroelectronics NV and its subsidiaries ("ST") reserve the right to make changes, corrections, modifications or improvements, to this document, and the products and services described herein at any time, without notice.

All ST products are sold pursuant to ST's terms and conditions of sale.

Purchasers are solely responsible for the choice, selection and use of the ST products and services described herein, and ST assumes no liability whatsoever relating to the choice, selection or use of the ST products and services described herein.

No license, express or implied, by estoppel or otherwise, to any intellectual property rights is granted under this document. If any part of this document refers to any third party products or services it shall not be deemed a license grant by ST for the use of such third party products or services, or any intellectual property contained therein or considered as a warranty covering the use in any manner whatsoever of such third party products or services or any intellectual property contained therein.

UNLESS OTHERWISE SET FORTH IN ST'S TERMS AND CONDITIONS OF SALE ST DISCLAIMS ANY EXPRESS OR IMPLIED WARRANTY WITH RESPECT TO THE USE AND/OR SALE OF ST PRODUCTS INCLUDING WITHOUT LIMITATION IMPLIED WARRANTIES OF MERCHANTABILITY, FITNESS FOR A PARTICULAR PURPOSE (AND THEIR EQUIVALENTS UNDER THE LAWS OF ANY JURISDICTION), OR INFRINGEMENT OF ANY PATENT, COPYRIGHT OR OTHER INTELLECTUAL PROPERTY RIGHT.

UNLESS EXPRESSLY APPROVED IN WRITING BY TWO AUTHORIZED ST REPRESENTATIVES, ST PRODUCTS ARE NOT RECOMMENDED, AUTHORIZED OR WARRANTED FOR USE IN MILITARY, AIR CRAFT, SPACE, LIFE SAVING, OR LIFE SUSTAINING APPLICATIONS, NOR IN PRODUCTS OR SYSTEMS WHERE FAILURE OR MALFUNCTION MAY RESULT IN PERSONAL INJURY, DEATH, OR SEVERE PROPERTY OR ENVIRONMENTAL DAMAGE. ST PRODUCTS WHICH ARE NOT SPECIFIED AS "AUTOMOTIVE GRADE" MAY ONLY BE USED IN AUTOMOTIVE APPLICATIONS AT USER'S OWN RISK.

Resale of ST products with provisions different from the statements and/or technical features set forth in this document shall immediately void any warranty granted by ST for the ST product or service described herein and shall not create or extend in any manner whatsoever, any liability of ST.

ST and the ST logo are trademarks or registered trademarks of ST in various countries.

Information in this document supersedes and replaces all information previously supplied.

The ST logo is a registered trademark of STMicroelectronics. All other names are the property of their respective owners.

© 2011 STMicroelectronics - All rights reserved

STMicroelectronics group of companies

Australia - Belgium - Brazil - Canada - China - Czech Republic - Finland - France - Germany - Hong Kong - India - Israel - Italy - Japan - Malaysia - Malta - Morocco - Philippines - Singapore - Spain - Sweden - Switzerland - United Kingdom - United States of America

www.st.com