

## KHS Series Datasheet

Power Wirewound Resistor | Axial | Fiber glass core | ceramic case

### ORDERING CODE - Example

New SAP Part Nr.:

<b>KHS</b>	<b>500</b>	<b>K</b>	<b>B</b>	<b>-</b>	<b>AX-</b>	<b>150R</b>	<b>AA</b>
Serie	Power rating	Tol. J = ±5% K = ±10%	Pack-Code B = Bulk R = Tape Reel	TCR - Base on spec.	Forming type AX- = Axial 83- Inner Taping dimension	R Value	Special AA = Standard

Historical VTM Part Nr.:

<b>KH208 - 8</b>	<b>5</b>	<b>B</b>	<b>150R</b>
Type	Tol. J = ±5% K = ±10%	Pack-Code B = Bulk R = Tape Reel	R Value

### APPLICATIONS



Industrial



Power & Energy

### FEATURES

Pulse version available  
preforming ; Other preforming available  
RoHs Compliant

### ELECTRICAL SPECIFICATIONS

Type		KHS400	KHS500	KHS700	KHS800	KHS10A	KHS11A	KHS17A
Historical Part Number		KH206-8	KH208-8	KH210-8	KH212-8	KH214-8	KH216-8	KH218-8
Nominal Power Rating P <sub>70</sub>	[W]	4	5	7	8	10	11	17
Resistance Range	Min.	Please check the table below						
	Max.	12K	15K	33K	15K	33K	47K	82K
E-Series (preferred)		E24 = 5% ; E12 = 10% (Other upon request)						
Tolerances	±[%]	J = 5% ; K = 10%						
Temperature Coefficient	±[10 <sup>-6</sup> K <sup>-1</sup> ]	Depends on the value, please check the table below						
Working Temperature Range	[°C]	-55 ... +350						
Thermal Resistance	[KW <sup>-1</sup> ]	70	56	40	35	28	25	16
Insulation Resistance IEC60115-1 clause 4.6	[MΩ]	> 10 <sup>4</sup>						
Max. Working Voltage	[V] <sub>RMS</sub>	$\sqrt{P_{70} \times R}$						
Dielectric Withstanding Voltage IEC60115-1 clause 4.7 (1[min])	[V] <sub>RMS</sub>	2000						

### DIMENSIONS [mm]

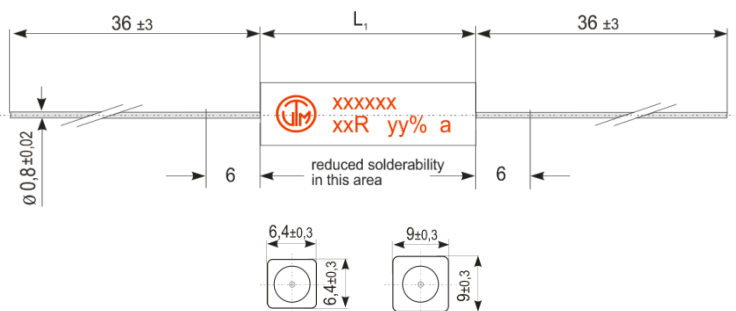

KHS400...KHS700    KHS800...KHS17A

Type	Historical P/N:	L <sub>1</sub>
KHS400	KH206 - 8	20 ±1,0
KHS500	KH208 - 8	25 ±1,0
KHS700	KH210 - 8	38 ±1,0
KHS800	KH212 - 8	25 ±1,0
KHS10A	KH214 - 8	38 ±1,0
KHS11A	KH216 - 8	50 ±1,5
KHS17A	KH218 - 8	75 ±2,0

# KHS Series Datasheet

## PERFORMANCE DATA

Type		KHS400	KHS500	KHS700	KHS800	KHS10A	KHS11A	KHS17A
Historical Part Number		KH206-8	KH208-8	KH210-8	KH212-8	KH214-8	KH216-8	KH218-8
Derating Linear	[°C]	70...350 (0W)						
Climatic Category		55/200/21						
Failure Rate <i>(Total, <math>\theta_o</math>, max, 60[%] cont. lev.)</i>	[10 <sup>-9</sup> h <sup>-1</sup> ]	appr. 100 depends on value						
Endurance <i>IEC60115-1 clause 4.25 (<math>P_{70}</math> @ 70[°C], 1000[h])</i>	±[%]	3						
Short Time Overload <i>IEC60115-1 clause 4.13 (10 times rated power for 5 seconds)</i>	±[%]	2,0						
Damp Heat, Steady State <i>IEC60115-1 clause 4.24 (40[°C], 93[% r.h.], 56[d])</i>	±[%]	2						
Climatic Sequence <i>IEC60115-1 clause 4.23</i>	±[%]	2						
Resistance to Soldering Heat <i>IEC60115-1 clause 4.18 (260<sup>±5</sup>[°C], 3,5<sup>±1</sup>[s])</i>	±[%]	0,2						
Terminal Strength	±[%]	1						
Terminal Tensile Strength	[N]	50						
Solderability <i>IEC60068-2-20 (245<sup>±5</sup>[°C] 3<sup>±0,5</sup>[s])</i>		Solder bath method (> 95% coverage)						
Marking <i>IEC60062</i>		Printed in clear						

## ELECTRICAL CHARACTERISTICS

### RESISTANCE RANGE (minimum)

New P/Nr. Type	Historical P/N:	± 10 [%]	± 5 [%]
<b>KHS400</b>	KH206 - 8	OR051	OR1
<b>KHS500</b>	KH208 - 8	OR075	OR15
<b>KHS700</b>	KH210 - 8	OR11	OR33
<b>KHS800</b>	KH212 - 8	OR075	OR15
<b>KHS10A</b>	KH214 - 8	OR11	OR33
<b>KHS11A</b>	KH216 - 8	OR15	OR51
<b>KHS17A</b>	KH218 - 8	OR27	OR91

### TEMPERATURE COEFFICIENT

New P/Nr. Type	Historical P/N:	400 ± 50 ppm/K		-20 ± 60 ppm/K		0 ± 10 ppm/K	
<b>KHS400</b>	KH206 - 8	≥ OR051	≤ OR2	≥ OR22	≤ 300R	≥ 330R	≤ 12K
<b>KHS500</b>	KH208 - 8	≥ OR075	≤ OR3	≥ OR33	≤ 470R	≥ 510R	≤ 15K
<b>KHS700</b>	KH210 - 8	≥ OR11	≤ OR68	≥ OR75	≤ 910R	≥ 1K	≤ 33K
<b>KHS800</b>	KH212 - 8	≥ OR075	≤ OR3	≥ OR33	≤ 470R	≥ 510R	≤ 15K
<b>KHS10A</b>	KH214 - 8	≥ OR11	≤ OR68	≥ OR75	≤ 910R	≥ 1K	≤ 33K
<b>KHS11A</b>	KH216 - 8	≥ OR15	≤ 1R	≥ 1R1	≤ 1K3	≥ 1K5	≤ 47K
<b>KHS17A</b>	KH218 - 8	≥ OR27	≤ 1R6	≥ 1R8	≤ 2K4	≥ 2K7	≤ 82K

# KHS Series Datasheet

## PERFORMANCE GRAPHS

**KHS400**

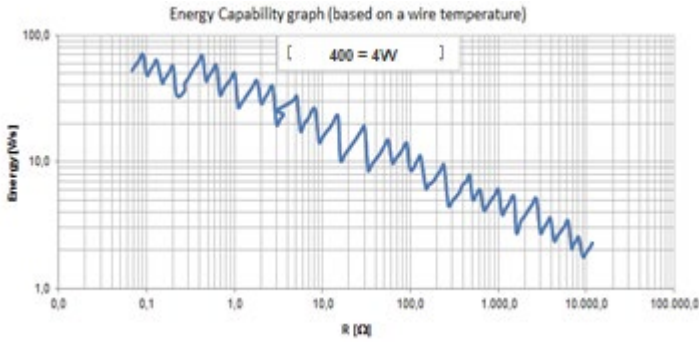

**KHS500 and KHS800**

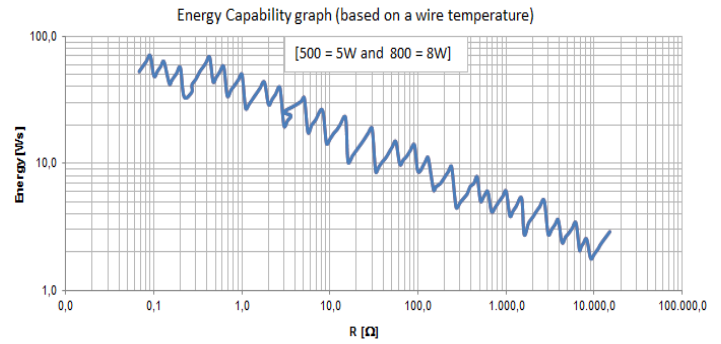

**KHS700 and KHS10A**

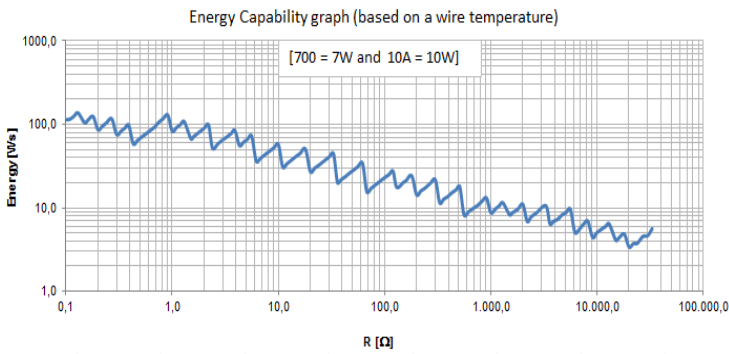

**KHS11A**

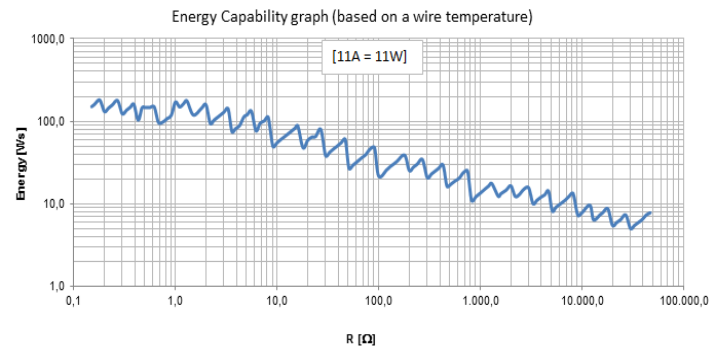

**KHS17A**

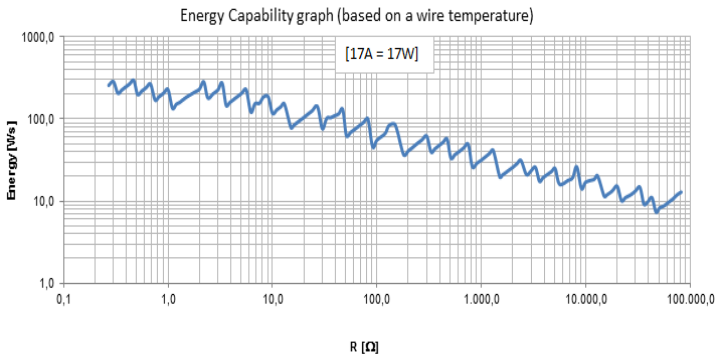

# KHS Series Datasheet

## PACKAGING

The standard packaging for KHS in axial type is bulk, dimensions below.

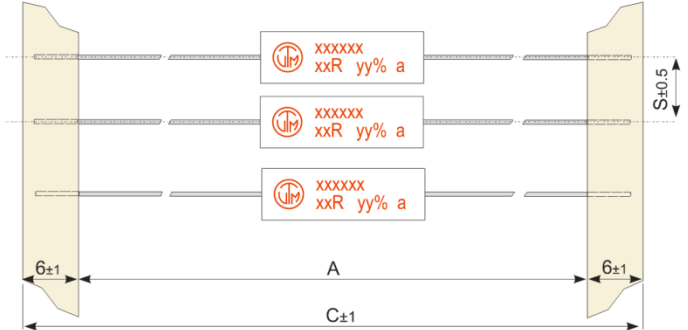

## ALTERNATIVE LEAD CONFIGURATIONS

This type KHS is also available in a different pre-forming, as shown below, other's upon request.

New P/Nr. Type	Historical P/N:	Pack Code	Pieces	Forming Type
KHS400	KH206 - 8	B = Bulk	200	AX- = Axial
KHS500	KH208 - 8		200	
KHS700	KH210 - 8		200	
KHS800	KH212 - 8		200	
KHS10A	KH214 - 8		100	
KHS11A	KH216 - 8		100	
KHS17A	KH218 - 8		100	

New P/Nr. Type	Historical P/N:	Pack Code	Pieces	Forming Type (Inner Taping dim.)	A	C	S
KHS400	KH206 - 8	R = Taped in Reel	1000	83-	83	95	10
KHS500	KH208 - 8		1000		83	95	10
KHS700	KH210 - 8		1000		83	95	10
KHS800	KH212 - 8		500		83	95	10
KHS10A	KH214 - 8		500		83	95	10
			500		83	95	10

## THROUGH HOLE VERSION

Axial Goal Post (AG-)	Axial Goal Post Kink (AK-)	Radial (RD-)	Radial 2 Kink (RK-)

For horizontal and vertical pre-forming please consult your local sales contact.

# Mouser Electronics

Authorized Distributor

Click to View Pricing, Inventory, Delivery & Lifecycle Information:

## YAGEO:

[KHS500JR-83-100RAA](#) [KHS400JB-AX-470RAA](#) [KHS10AJB-AX-100RAA](#) [KHS10AJB-AX-10RAA](#) [KHS500JB-AX-100RAA](#) [KHS500JB-AX-10RAA](#) [KHS500JB-AX-1RAA](#) [KHS400JB-AX-10RAA](#) [KHS10AJB-AX-2K2AA](#) [KHS10AJB-AX-47RAA](#) [KHS10AJB-AX-1KAA](#) [KHS17AJB-AX-100RAA](#) [KHS17AJB-AX-10KAA](#) [KHS17AJB-AX-470RAA](#) [KHS17AJB-AX-6K8AA](#) [KHS17AJB-AX-7K5AA](#) [KHS400JB-AX-100RAA](#) [KHS400JB-AX-1K2AA](#) [KHS400JB-AX-2K2AA](#) [KHS500JB-AX-1KAA](#) [KHS500JB-AX-390RAA](#) [KHS400JB-AX-3R3AA](#) [KHS500KB-AX-22RAA](#) [KHS400JB-AX-180RAA](#) [KHS500JB-AX-R68AA](#) [KHS800KB-AX-47RAA](#) [KHS500JB-AX-120RAA](#) [KHS10AKB-AX-680RAA](#) [KHS800JB-AX-R22AA](#) [KHS800JB-AX-22RAA](#) [KHS400KB-AX-3K3AA](#) [KHS10AKB-AX-100RAA](#) [KHS10AKB-AX-10RAA](#) [KHS10AKB-AX-15RAA](#) [KHS10AKB-AX-18KAA](#) [KHS10AKB-AX-1KAA](#) [KHS10AKB-AX-22KAA](#) [KHS10AKB-AX-39RAA](#) [KHS10AKB-AX-470RAA](#) [KHS10AKB-AX-8R2AA](#) [KHS11AJB-AX-33RAA](#) [KHS11AKB-AX-10RAA](#) [KHS11AKB-AX-15RAA](#) [KHS11AKB-AX-22RAA](#) [KHS11AKB-AX-27RAA](#) [KHS11AKB-AX-33RAA](#) [KHS11AKB-AX-6R8AA](#) [KHS11AKB-AX-R33AA](#) [KHS17AKB-AX-18KAA](#) [KHS17AKB-AX-3R3AA](#) [KHS17AKB-AX-560RAA](#) [KHS400JB-AX-1RAA](#) [KHS400JB-AX-R1AA](#) [KHS400JB-AX-R22AA](#) [KHS400KB-AX-100RAA](#) [KHS400KB-AX-10RAA](#) [KHS400KB-AX-150RAA](#) [KHS400KB-AX-15RAA](#) [KHS400KB-AX-220RAA](#) [KHS400KB-AX-300RAA](#) [KHS400KB-AX-390RAA](#) [KHS400KB-AX-470RAA](#) [KHS400KB-AX-47RAA](#) [KHS400KB-AX-R1AA](#) [KHS400KB-AX-R22AA](#) [KHS400KB-AX-R82AA](#) [KHS500JB-AX-15KAA](#) [KHS500JB-AX-1K2AA](#) [KHS500JB-AX-330RAA](#) [KHS500JB-AX-47RAA](#) [KHS500KB-AX-100RAA](#) [KHS500KB-AX-10KAA](#) [KHS500KB-AX-10RAA](#) [KHS500KB-AX-120RAA](#) [KHS500KB-AX-12KAA](#) [KHS500KB-AX-12RAA](#) [KHS500KB-AX-150RAA](#) [KHS500KB-AX-15RAA](#) [KHS500KB-AX-180RAA](#) [KHS500KB-AX-1KAA](#) [KHS500KB-AX-1RAA](#) [KHS500KB-AX-220RAA](#) [KHS500KB-AX-270RAA](#) [KHS500KB-AX-2K2AA](#) [KHS500KB-AX-2R2AA](#) [KHS500KB-AX-330RAA](#) [KHS500KB-AX-33RAA](#) [KHS500KB-AX-390RAA](#) [KHS500KB-AX-3R3AA](#) [KHS500KB-AX-470RAA](#) [KHS500KB-AX-47RAA](#) [KHS500KB-AX-4K7AA](#) [KHS500KB-AX-56RAA](#) [KHS500KB-AX-5R1AA](#) [KHS500KB-AX-5R6AA](#) [KHS500KB-AX-6K8AA](#) [KHS500KB-AX-82RAA](#) [KHS500KB-AX-8R2AA](#) [KHS500KB-AX-R1AA](#) [KHS500KB-AX-R22AA](#)