

## 3A, 1000V Fast Recovery Glass Passivated Bridge Rectifier

### FEATURES

- Glass passivated junction
- Ideal for automated placement
- UL Recognized File # E-326854
- Moisture sensitivity level: level 1, per J-STD-020
- RoHS Compliant
- Halogen-free according to IEC 61249-2-21

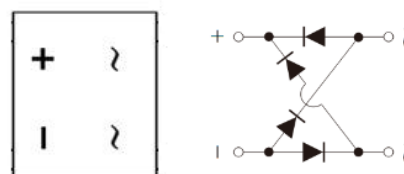
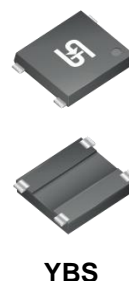
### APPLICATIONS

- Switching mode power supply (SMPS)
- Adapters
- TV
- Monitor

### MECHANICAL DATA

- Case: YBS
- Molding compound meets UL 94V-0 flammability rating
- Matte tin plated leads, solderable per J-STD-002
- Meet JESD 201 class 1 whisker test
- Polarity: As marked
- Weight: 0.22g (approximately)

KEY PARAMETERS		
PARAMETER	VALUE	UNIT
$I_F$	3.0	A
$V_{RRM}$	1000	V
$I_{FSM}$	90	A
$T_{JMAX}$	150	°C
Package	YBS	
Configuration	Quad	



ABSOLUTE MAXIMUM RATINGS ( $T_A = 25^\circ\text{C}$ unless otherwise noted)			
PARAMETER		RYBS30M	UNIT
Marking code on the device		RY30M	
Repetitive peak reverse voltage	$V_{RRM}$	1000	V
Reverse voltage, total rms value	$V_{R(RMS)}$	700	V
Forward current	$I_F$	3.0	A
Surge peak forward current single half sine-wave superimposed on rated load per diode	8.3 ms at $T_A = 25^\circ\text{C}$	90	A
	1.0 ms at $T_A = 25^\circ\text{C}$	220	A
$I^2t$ value (of a surge on-state current) at 8.3ms	$I^2t$	33	$\text{A}^2\text{s}$
Junction temperature	$T_J$	-55 to +150	°C
Storage temperature	$T_{STG}$	-55 to +150	°C

**THERMAL PERFORMANCE**

PARAMETER	SYMBOL	TYP	UNIT
Junction-to-lead thermal resistance	$R_{\theta JL}$	13	°C/W
Junction-to-ambient thermal resistance	$R_{\theta JA}$	58	°C/W
Junction-to-case thermal resistance	$R_{\theta JC}$	11	°C/W

**Thermal Performance Note:** Units mounted on recommended PCB (16mm x 16mm Cu pad test board)

**ELECTRICAL SPECIFICATIONS** ( $T_A = 25^\circ\text{C}$  unless otherwise noted)

PARAMETER	CONDITIONS	SYMBOL	TYP	MAX	UNIT
Forward voltage <sup>(1)</sup>	$I_F = 1.5 \text{ A}, T_J = 25^\circ\text{C}$	$V_F$	1.01	-	V
	$I_F = 3.0 \text{ A}, T_J = 25^\circ\text{C}$		1.10	1.30	V
	$I_F = 1.5 \text{ A}, T_J = 125^\circ\text{C}$		0.84	-	V
	$I_F = 3.0 \text{ A}, T_J = 125^\circ\text{C}$		0.95	1.17	V
Reverse current @ rated $V_R$ <sup>(2)</sup>	$T_J = 25^\circ\text{C}$	$I_R$	-	5	$\mu\text{A}$
	$T_J = 125^\circ\text{C}$		-	167	$\mu\text{A}$
Junction capacitance	1 MHz, $V_R = 4.0\text{V}$	$C_J$	35	-	pF
Reverse recovery time	$I_F = 0.5\text{A}, I_R = 1.0\text{A}$ $I_{RR} = 0.25\text{A}$	$t_{rr}$	-	300	ns

**Notes:**

1. Pulse test with PW=0.3 ms
2. Pulse test with PW=30 ms

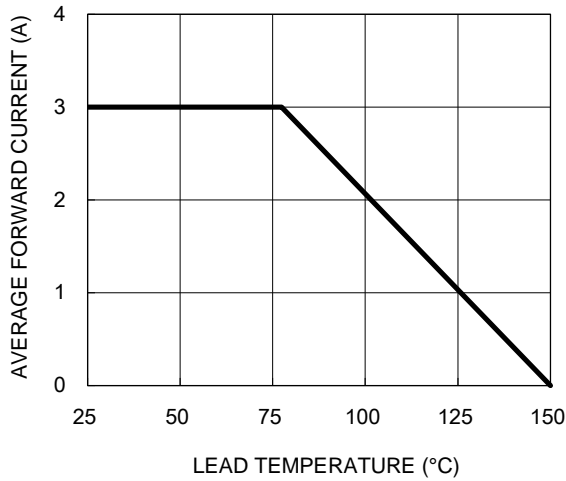
**ORDERING INFORMATION**

ORDERING CODE	PACKAGE	PACKING
RYBS30M M2G	YBS	3,000 / 13" Reel

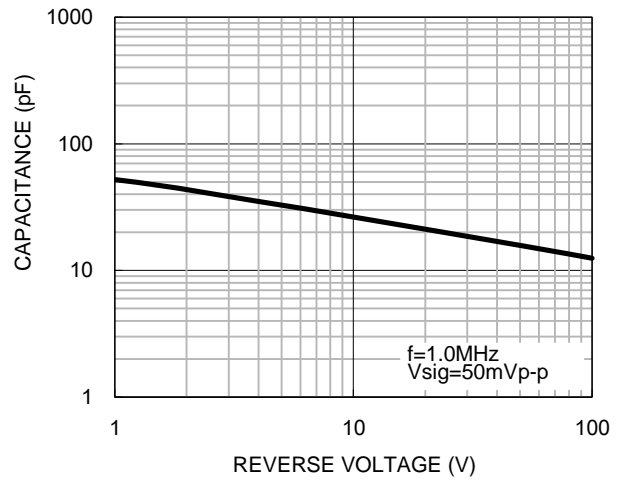
**CHARACTERISTICS CURVES**

( $T_A = 25^\circ\text{C}$  unless otherwise noted)

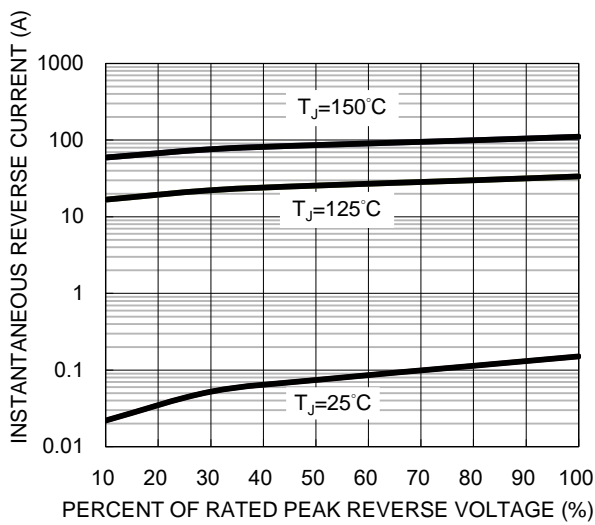
**Fig.1 Forward Current Derating Curve**



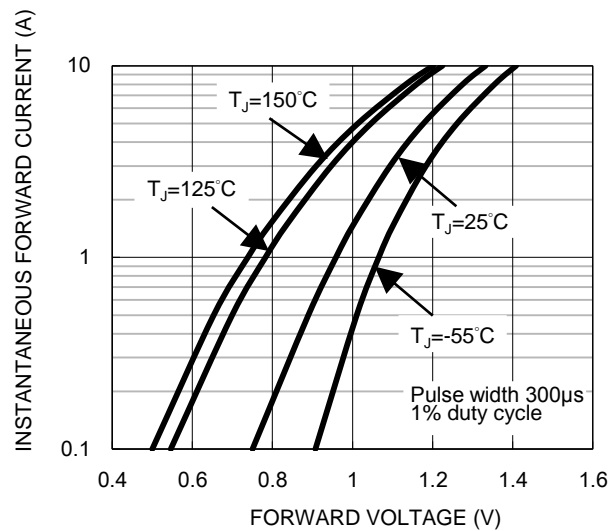
**Fig.2 Typical Junction Capacitance**



**Fig.3 Typical Reverse Characteristics**

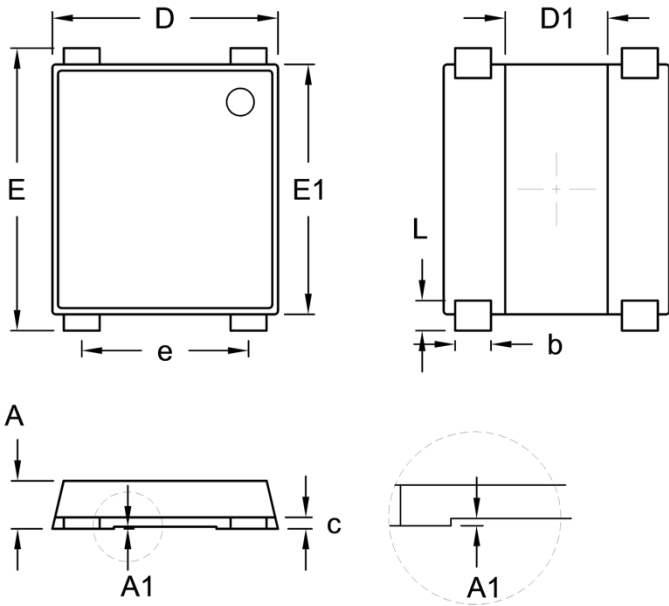


**Fig.4 Typical Forward Characteristics**



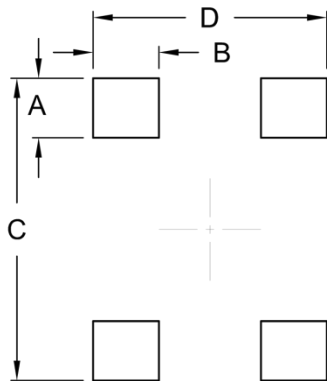
**PACKAGE OUTLINE DIMENSIONS** (Unit: Millimeters)

YBS



DIM.	Unit (mm)		Unit (inch)	
	Min.	Max.	Min.	Max.
A	1.30	1.50	0.051	0.059
A1	0.04	0.08	0.002	0.003
b	0.95	1.15	0.037	0.045
c	0.27	0.40	0.011	0.016
D	6.50	6.70	0.256	0.264
D1	2.90	3.10	0.114	0.122
E	7.90	8.60	0.311	0.339
E1	7.20	7.40	0.283	0.291
e	5.00	5.20	0.197	0.205
L	0.70	1.05	0.028	0.041

**SUGGESTED PAD LAYOUT**



Symbol	Unit (mm)	Unit (inch)
A	1.80	0.070
B	2.00	0.078
C	9.15	0.360
D	7.10	0.279

**MARKING DIAGRAM**



P/N = Marking Code  
 YW = Date Code  
 F = Factory Code

## Notice

Specifications of the products displayed herein are subject to change without notice. TSC or anyone on its behalf, assumes no responsibility or liability for any errors or inaccuracies.

Purchasers are solely responsible for the choice, selection, and use of TSC products and TSC assumes no liability for application assistance or the design of Purchasers' products.

Information contained herein is intended to provide a product description only. No license, express or implied, to any intellectual property rights is granted by this document. Except as provided in TSC's terms and conditions of sale for such products, TSC assumes no liability whatsoever, and disclaims any express or implied warranty, relating to sale and/or use of TSC products including liability or warranties relating to fitness for a particular purpose, merchantability, or infringement of any patent, copyright, or other intellectual property right.

The products shown herein are not designed for use in medical, life-saving, or life-sustaining applications. Customers using or selling these products for use in such applications do so at their own risk and agree to fully indemnify TSC for any damages resulting from such improper use or sale.