

## AFBR-S4N44P163

### 4×4 NUV-HD Silicon Photo Multiplier Array

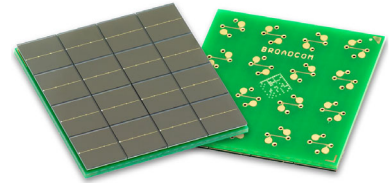

#### Description

The Broadcom® AFBR-S4N44P163 is a 4×4 Silicon Photo Multiplier (SiPM) array used for ultra-sensitive precision measurements of single photons. The pitch of SiPMs is 4 mm in both directions. High packing density of the single chips is achieved using through-silicon-via (TSV) technology. Larger areas can be covered with a pitch of 16 mm by tiling multiple AFBR-S4N44P163 arrays almost without any edge losses. The passivation layer is made by a glass highly transparent down to UV wavelengths, resulting in a broad response in the visible light spectrum with high sensitivity towards blue- and near-UV region of the light spectrum. The array is best suited for the detection of low-level pulsed light sources, especially for detection of Cherenkov- or scintillation light from the most common organic (plastic) and inorganic scintillator materials (for example, LSO, LYSO, BGO, NaI, CsI, BaF, LaBr). This product is lead free and compliant with RoHS and REACH.

#### Features

- High PDE of more than 55% at 420 nm
- High fill factors
- Excellent SPTR and CRT
- Excellent uniformity of breakdown voltage, 180 mV (3 sigma)
- Excellent uniformity of gain
- With TSV technology (4-side tilable)
- Size 15.9 × 15.9 mm<sup>2</sup>
- Cell pitch 30 × 30 μm<sup>2</sup>
- Highly transparent glass protection layer
- Operating temperature range from –20°C to +50°C
- RoHS and REACH compliant

#### Applications

- X-ray and gamma ray detection
- Gamma ray spectroscopy
- Safety and security
- Nuclear medicine
- Positron emission tomography
- Life sciences
- Flow cytometry
- Fluorescence — luminescence measurements
- Time correlated single photon counting
- High energy physics
- Astrophysics

## Block Diagram

Figure 1: AFBR-S4N44P163 Block Diagram of Single SiPM Element

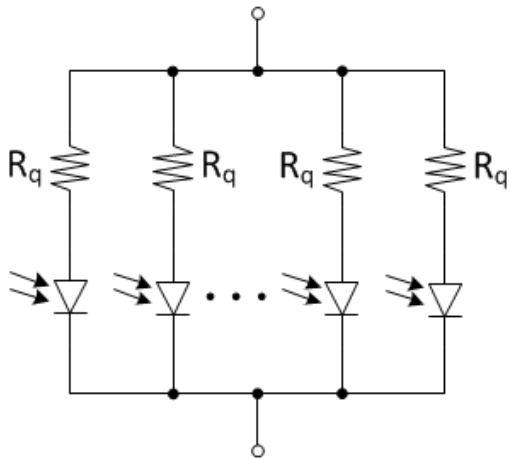

## Pad Layout

The AFBR-S4N44P163 has 32 signal pins. The anode and the cathode of each SiPM chip can be connected separately. The cathodes do not have a common connection on the module. The pad layout is shown in [Figure 2](#).

Figure 2: Pad Layout

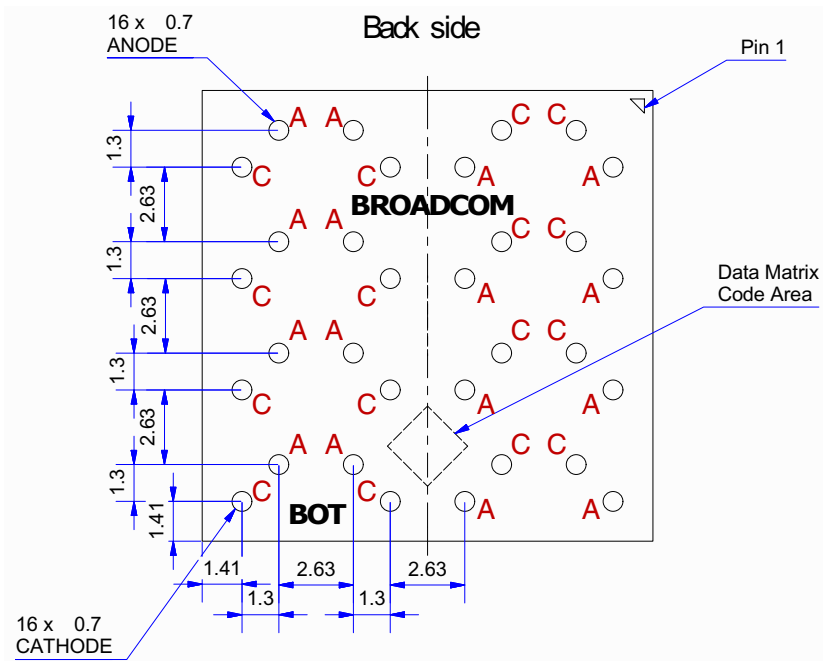

**NOTE:**

1. Dimensions: mm.
2. A stands for anode, C stands for cathode.

## Regulatory Compliance Table

Feature	Test Method	Performance
Electrostatic discharge (ESD) to the electrical pins, Human Body Model (contact ESD)	JESD22-A114	Refer to <a href="#">Absolute Maximum Ratings</a> (2 kV)
Electrostatic discharge (ESD) to the electrical pins, Charged Device Model	JESD22-C101F	Refer to <a href="#">Absolute Maximum Ratings</a> (500V)
Storage compliance MSL	J-STD-020D	3 (168 hours floor life time)
Restriction of hazardous substances directive	RoHS Directive 2011/65/EU Annex II	Certified compliant

## Reflow Soldering Diagram

Figure 3: Recommended Reflow Soldering Profile

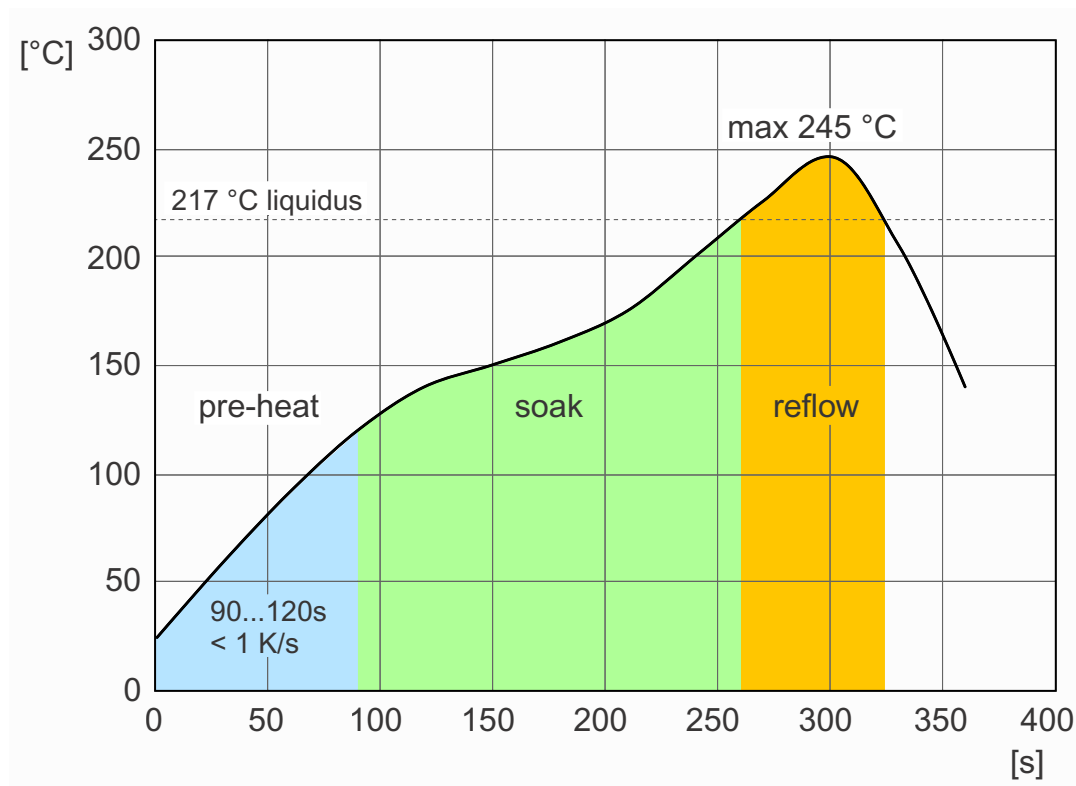

## Absolute Maximum Ratings

Stresses in excess of the absolute maximum ratings can cause damage to the devices. Limits apply to each parameter in isolation. Absolute maximum ratings are those values beyond which damage to the device may occur if these limits are exceeded for other than a short period of time.

Parameter	Symbol	Min.	Max.	Units
Storage Temperature	$T_{STG}$	-20	+60	°C
Operating Temperature <sup>a</sup>	$T_A$	-20	+50	°C
Soldering Temperature <sup>b, c</sup>	$T_{SOLD}$	—	245	°C
Lead Soldering Time <sup>b, c</sup>	$t_{SOLD}$	—	60	s
Electrostatic Discharge Voltage Capability HBM	$ESD_{HBM}$	—	2	kV
Electrostatic Discharge Voltage Capability CDM	$ESD_{CDM}$	—	500	V
Operating Over Voltage	$V_{OV}$	—	10	V

- a. Biased at constant voltage = 5V above breakdown.
- b. The tile is reflow solderable according to the solder diagram shown in [Figure 3](#).
- c. According to JEDEC J-STD-020D, the moisture sensitivity classification is MSL3.

## Single Device Specification

Features measured at 25°C unless otherwise specified.

### Geometric Features

Parameter	Symbol	Value	Units
Single device area	DA	3.88 × 3.88	mm <sup>2</sup>
Active area	AA	3.72 × 3.72	mm <sup>2</sup>
Micro cell pitch	$L_{cell}$	30	μm
Number of micro cells	$N_{cells}$	15060	
Micro cell fill factor	FF	76	%

## Optical and Electrical Features

Two recommended working points: Typical (*Typ.*) for general purpose applications and Performance (*Perf.*) for best timing performance.

Parameter	Symbol	Min.	Typ.	Max.	Units	Reference Plots
Spectral range	$\lambda$	300	—	900	nm	<a href="#">Figure 4</a>
Peak sensitivity wavelength	$\lambda_{PK}$	—	420	—	nm	<a href="#">Figure 4</a>
Breakdown voltage	$V_{BD}$	—	26.9	—	V	<a href="#">Figure 6</a>
Temperature coefficient of breakdown voltage	$\Delta V_{BR}/\Delta T$	—	26	—	mV/K	

Parameter	Symbol	Typ. <sup>a</sup>	Perf. <sup>a</sup>	Units	Reference Plots
Photo detection efficiency <sup>b</sup>	PDE	43	55	%	<a href="#">Figure 5</a>
Dark current	$I_D$	0.5	3.4	$\mu A$	<a href="#">Figure 6</a>
Dark count rate <sup>c</sup>	DCR	1.7	3.7	MHz	<a href="#">Figure 7</a> , <a href="#">Figure 10</a>
Dark count rate per unit area	$DCR_{mm^2}$	120	270	$kHz/mm^2$	
Gain	G	1.6	3.3	$\times 10^6$	<a href="#">Figure 8</a> , <a href="#">Figure 11</a>
Optical crosstalk	$P_{Xtalk}$	9	29	%	<a href="#">Figure 9</a> , <a href="#">Figure 12</a>
Afterpulsing probability	$P_{AP}$	<1	1	%	<a href="#">Figure 9</a> , <a href="#">Figure 12</a>
Recharge time constant <sup>d</sup>	$\tau_{fall}$	55	50	ns	<a href="#">Figure 13</a>
Nominal terminal capacitance <sup>e</sup>	$C_T$	990	760	pF	
Temperature coefficient of gain <sup>f</sup>	$\Delta G/\Delta T$	1.1	1.0	$\times 10^4/K$	

a. Typical values are measured at 3V above breakdown, performance at 7V above breakdown.

b. Measured at peak sensitivity wavelength. Measurement does not include correlated noise, such as afterpulsing or optical cross-talk.

c. Measured at 0.5 p.e. amplitude. Measurement does not include delayed correlated events.

d. Measured on  $1 \times 1 \text{ mm}^2$  devices with an input impedance of  $20\Omega$ .

e. Measured using input sine wave with  $f = 100 \text{ kHz}$  and  $V_{in} = 100 \text{ mV}$ .

f. Calculated from gain dependence on V and breakdown voltage temperature coefficient:  $dG/dT = dG/dV \times dV_{BD}/dT$ .

# Reference Plots

Features measured at 25°C unless otherwise specified.

**Figure 4: Typical PDE vs. Wavelength**

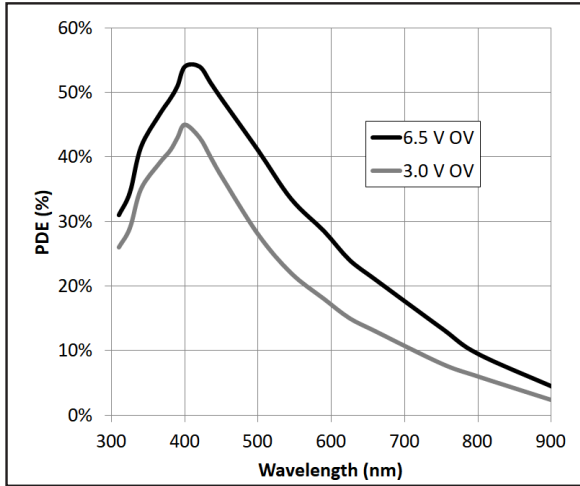

**Figure 5: Typical PDE at Peak  $\lambda$  vs. OV**

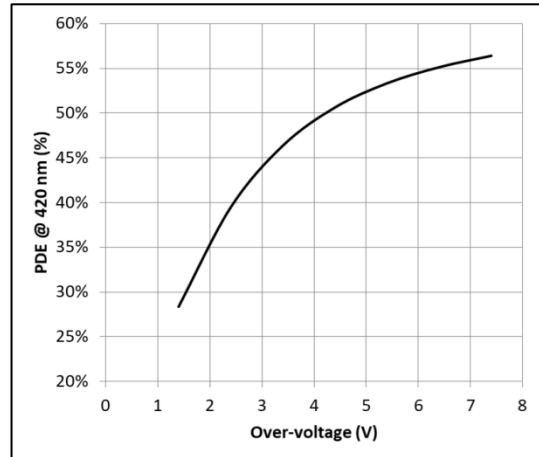

**Figure 6: Typical Reverse IV Curve<sup>1</sup>**

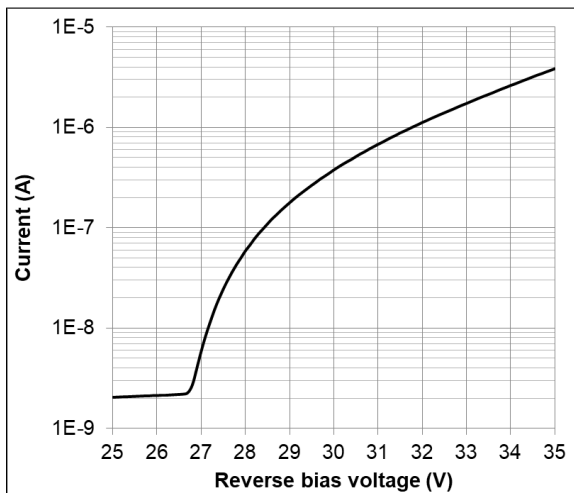

**Figure 7: Typical Dark Count Rate vs. OV<sup>1</sup>**

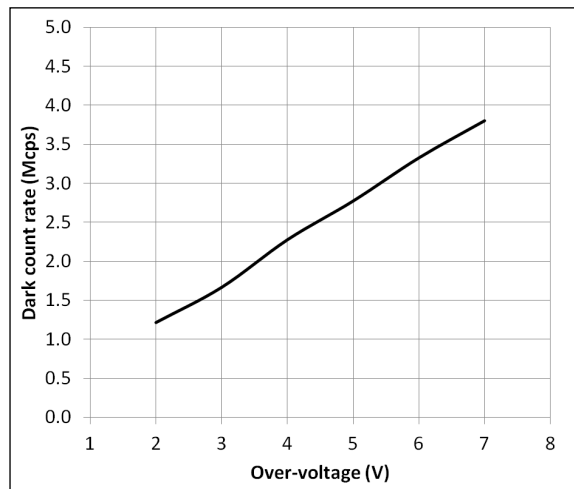

1. Measured on a single SiPM.

Figure 8: Typical Gain vs. OV

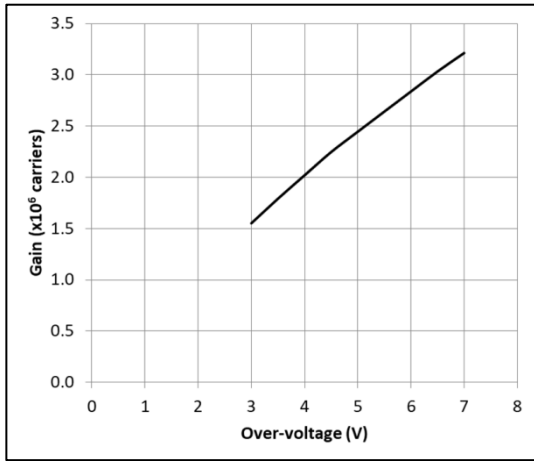

Figure 9: Typical Correlated Noise vs. OV

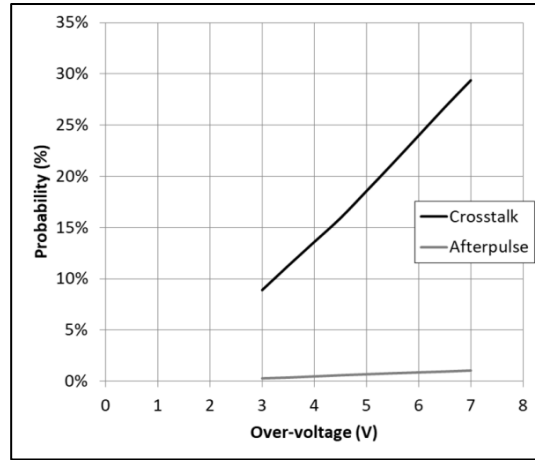

Figure 10: Typical Dark Count Rate vs. PDE at Peak  $\lambda$

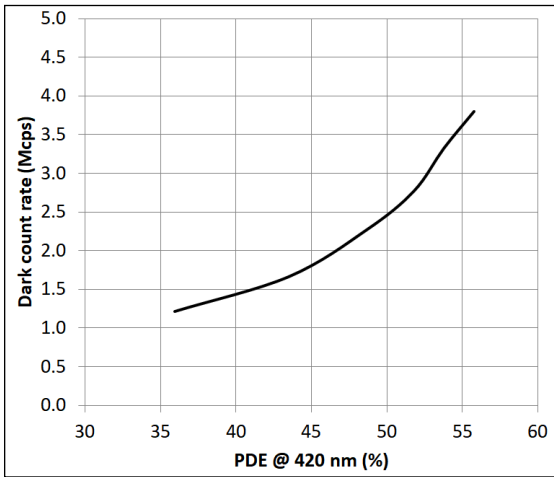

Figure 11: Typical Gain vs. PDE at Peak  $\lambda$

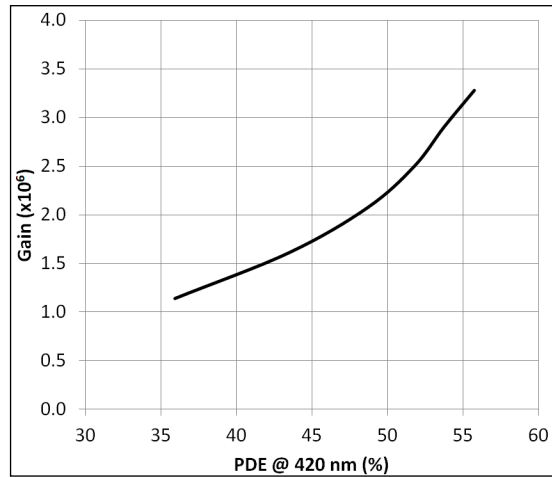

Figure 12: Typical Correlated Noise vs. PDE at Peak  $\lambda$

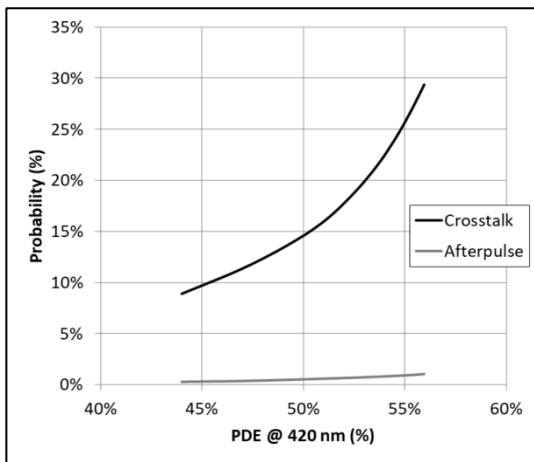
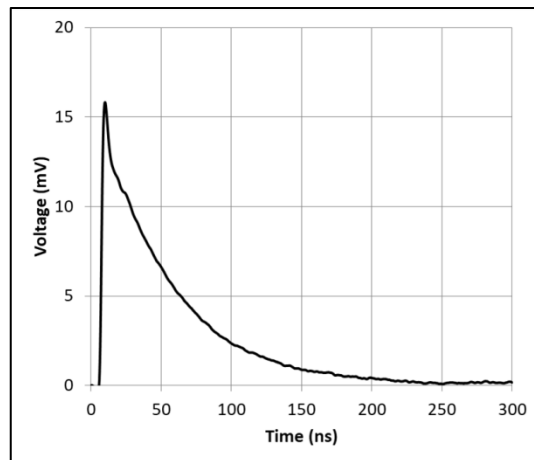

Figure 13: Typical Example Signal Measured at 3V OV



# Array Specification

Two recommended operating voltages: Typical (*Typ.*) for general purpose applications and Performance (*Perf.*) for best timing performance.

Parameter	Symbol	Min.	Typ.	Max.	Perf.	Units	Reference Plot
Number of SiPMs per array		16			—		
Array arrangement		4 × 4 chips			—		
Package fill factor		95			—	%	
Breakdown voltage spread	$\Delta V_{BD}$	—	200	—	—	mV	
Dark current sum	$\Sigma I_{DK}$	—	22	—	100	$\mu A$	

## Mechanical Data – Package Outline

Figure 14: Package Outline Drawing

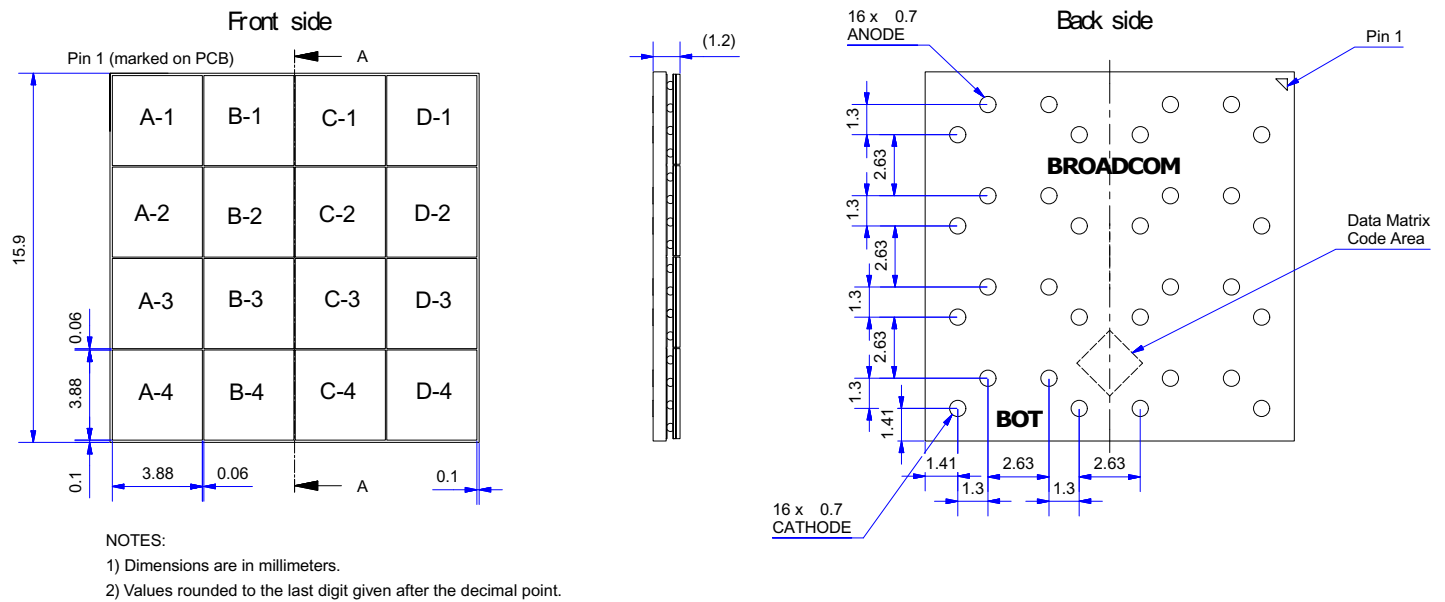



Broadcom, the pulse logo, Connecting everything, Avago Technologies, Avago, and the A logo are among the trademarks of Broadcom and/or its affiliates in the United States, certain other countries, and/or the EU.

Copyright © 2018 Broadcom. All Rights Reserved.

The term “Broadcom” refers to Broadcom Inc. and/or its subsidiaries. For more information, please visit [www.broadcom.com](http://www.broadcom.com).

Broadcom reserves the right to make changes without further notice to any products or data herein to improve reliability, function, or design. Information furnished by Broadcom is believed to be accurate and reliable. However, Broadcom does not assume any liability arising out of the application or use of this information, nor the application or use of any product or circuit described herein, neither does it convey any license under its patent rights nor the rights of others.



# Mouser Electronics

Authorized Distributor

Click to View Pricing, Inventory, Delivery & Lifecycle Information:

[Broadcom Limited:](#)

[AFBR-S4N44P163](#)