

**Product number C12041\_EVA-S**

Family	Eva	FWHM	13 degrees
Type	Lens	Efficiency	94 %
LED	XM-L	cd/lm	-
Color	Clear	Gerber File	Available
Diameter	35 mm		
Height	16.4 mm		
Style	Round		
Optic Material	PMMA		
Holder Material	-		
Fastening	-		
Status	Production ready		

**Product number CA12055\_EVA-S**

Family	Eva	FWHM	13 degrees
Type	Assembly	Efficiency	92 %
LED	XM-L	cd/lm	-
Color	Black	Gerber File	Available
Diameter	37.7 mm		
Height	17.2 mm		
Style	Round		
Optic Material	PMMA		
Holder Material	-		
Fastening	["tape", "screw"]		
Status	Production ready		

**Product number CP12196\_EVA-S**

Family	Eva	FWHM	13 degrees
Type	Assembly	Efficiency	94 %
LED	XM-L	cd/lm	-
Color	Black	Gerber File	Available
Diameter	37.7 mm		
Height	17 mm		
Style	Round		
Optic Material	PMMA		
Holder Material	-		
Fastening	["glue", "screw"]		
Status	Production ready		

**Product number C12828\_EVA-O**

Family	Eva	FWHM	15,5+39 degrees
Type	Lens	Efficiency	86 %
LED	XM-L	cd/lm	3.300
Color	Clear	Gerber File	Available
Diameter	35 mm		
Height	16.4 mm		
Style	Round		
Optic Material	PMMA		
Holder Material	-		
Fastening	-		
Status	Production ready		

**Product number CA12859\_EVA-O**

Family	Eva	FWHM	15,5+39 degrees
Type	Assembly	Efficiency	86 %
LED	XM-L	cd/lm	3.300
Color	Black	Gerber File	Available
Diameter	37.7 mm		
Height	17.2 mm		
Style	Round		
Optic Material	PMMA		
Holder Material	-		
Fastening	["tape"]		
Status	Production ready		

**Product number CP12860\_EVA-O**

Family	Eva	FWHM	15,5+39 degrees
Type	Assembly	Efficiency	86 %
LED	XM-L	cd/lm	3.300
Color	Black	Gerber File	Available
Diameter	37.7 mm		
Height	17 mm		
Style	Round		
Optic Material	PMMA		
Holder Material	-		
Fastening	["screw"]		
Status	Production ready		

**Product number C10684\_EVA-D**

Family	Eva	FWHM	16 degrees
Type	Lens	Efficiency	91 %
LED	XM-L	cd/lm	-
Color	Clear	Gerber File	Available
Diameter	35 mm		
Height	16.4 mm		
Style	Round		
Optic Material	PMMA		
Holder Material	-		
Fastening	-		
Status	Production ready		

**Product number CA12057\_EVA-D**

Family	Eva	FWHM	16 degrees
Type	Assembly	Efficiency	90 %
LED	XM-L	cd/lm	-
Color	Black	Gerber File	Available
Diameter	37.7 mm		
Height	17.2 mm		
Style	Round		
Optic Material	PMMA		
Holder Material	-		
Fastening	["tape", "screw"]		
Status	Production ready		

**Product number CP12197\_EVA-D**

Family	Eva	FWHM	20 degrees
Type	Assembly	Efficiency	91 %
LED	XM-L	cd/lm	-
Color	Black	Gerber File	Available
Diameter	37.7 mm		
Height	17 mm		
Style	Round		
Optic Material	PMMA		
Holder Material	-		
Fastening	["glue", "screw"]		
Status	Production ready		

**Product number C10685\_EVA-M**

Family	Eva	FWHM	24 degrees
Type	Lens	Efficiency	88 %
LED	XM-L	cd/lm	-
Color	Clear	Gerber File	Available
Diameter	35 mm		
Height	16.4 mm		
Style	Round		
Optic Material	PMMA		
Holder Material	-		
Fastening	-		
Status	Production ready		

**Product number CA12058\_EVA-M**

Family	Eva	FWHM	24 degrees
Type	Assembly	Efficiency	89 %
LED	XM-L	cd/lm	-
Color	Black	Gerber File	Available
Diameter	37.7 mm		
Height	17.2 mm		
Style	Round		
Optic Material	PMMA		
Holder Material	-		
Fastening	["tape", "screw"]		
Status	Production ready		

**Product number CP12198\_EVA-M**

Family	Eva	FWHM	24 degrees
Type	Assembly	Efficiency	88 %
LED	XM-L	cd/lm	-
Color	Black	Gerber File	Available
Diameter	37.7 mm		
Height	17 mm		
Style	Round		
Optic Material	PMMA		
Holder Material	-		
Fastening	["glue", "screw"]		
Status	Production ready		

**Product number C10686\_EVA-W**

Family	Eva	FWHM	40 degrees
Type	Lens	Efficiency	79 %
LED	XM-L	cd/lm	-
Color	Clear	Gerber File	Available
Diameter	35 mm		
Height	16.4 mm		
Style	Round		
Optic Material	PMMA		
Holder Material	-		
Fastening	-		
Status	Production ready		

**Product number CA12059\_EVA-W**

Family	Eva	FWHM	40 degrees
Type	Assembly	Efficiency	83 %
LED	XM-L	cd/lm	-
Color	Black	Gerber File	Available
Diameter	37.7 mm		
Height	17.2 mm		
Style	Round		
Optic Material	PMMA		
Holder Material	-		
Fastening	["tape", "screw"]		
Status	Production ready		

**Product number CP12199\_EVA-W**

Family	Eva	FWHM	40 degrees
Type	Assembly	Efficiency	79 %
LED	XM-L	cd/lm	-
Color	Black	Gerber File	Available
Diameter	37.7 mm		
Height	17 mm		
Style	Round		
Optic Material	PMMA		
Holder Material	-		
Fastening	["screw", "glue"]		
Status	Production ready		

**Product number C10909\_EVA-WW**

Family	Eva	FWHM	64 degrees
Type	Lens	Efficiency	77 %
LED	XM-L	cd/lm	-
Color	Clear	Gerber File	Available
Diameter	35 mm		
Height	16.4 mm		
Style	Round		
Optic Material	PMMA		
Holder Material	-		
Fastening	-		
Status	Production ready		



# PRODUCT DATASHEET

## Eva series

last update 20/12/2012

**Product number CA12060\_EVA-WW**

Family	Eva	FWHM	64 degrees
Type	Assembly	Efficiency	79 %
LED	XM-L	cd/lm	-
Color	Black	Gerber File	Available
Diameter	37.7 mm		
Height	17.2 mm		
Style	Round		
Optic Material	PMMA		
Holder Material	-		
Fastening	["screw", "tape"]		
Status	Production ready		

**Product number CP12200\_EVA-WW**

Family	Eva	FWHM	64 degrees
Type	Assembly	Efficiency	77 %
LED	XM-L	cd/lm	-
Color	Black	Gerber File	Available
Diameter	37.7 mm		
Height	17 mm		
Style	Round		
Optic Material	PMMA		
Holder Material	-		
Fastening	["screw", "glue"]		
Status	Production ready		

**NOTE: The typical divergence will be changed by different color, chip size and chip position tolerance. The typical total divergence is the full angle measured where the luminous intensity is half of the peak value.**



## PRODUCT DATASHEET

### Eva series

last update 20/12/2012

#### GENERAL INFORMATION

- Product series especially designed & optimized for XM-L series of LEDs.
- Special care taken to make light distribution as uniform as possible.
- Lens material optical grade PMMA with high UV and temperature resistance. Allows use of high current and temperature conditions.

Please find more information about used material from below:

[http://ledil.fi/sites/default/files/Documents/Technical/Material/PMMA%20N%20UL94\\_Yellow%20Card.pdf](http://ledil.fi/sites/default/files/Documents/Technical/Material/PMMA%20N%20UL94_Yellow%20Card.pdf)

<http://ledil.fi/sites/default/files/Documents/Technical/Material/PMMA%20N%20PLEXIGLAS-Datasheet.pdf>

Relative intensity of CA12059\_Eva-W-XM-Tape

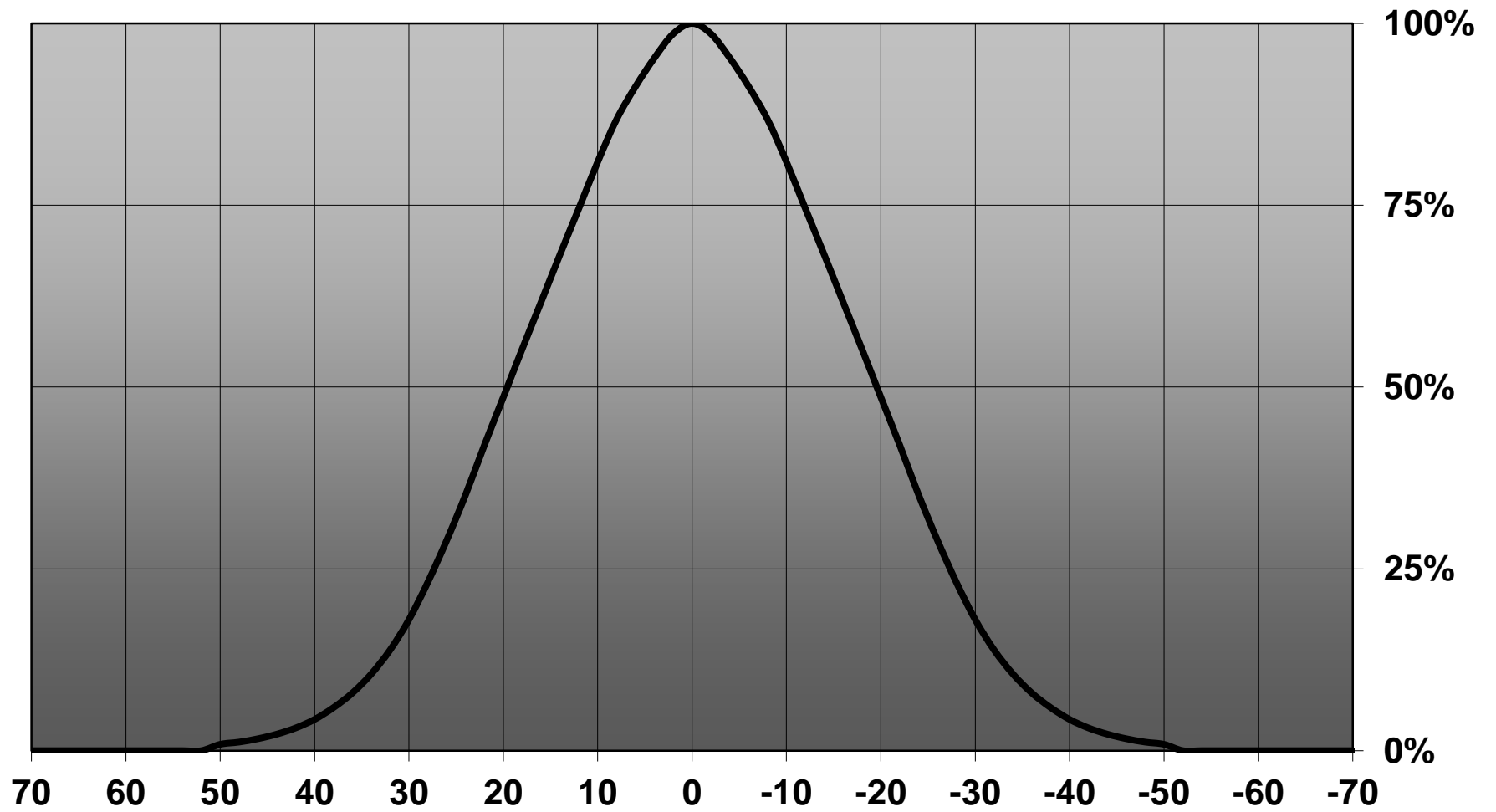

D

C

B

A

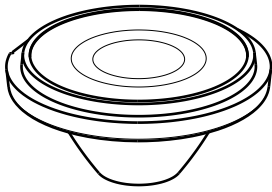

Isometric view

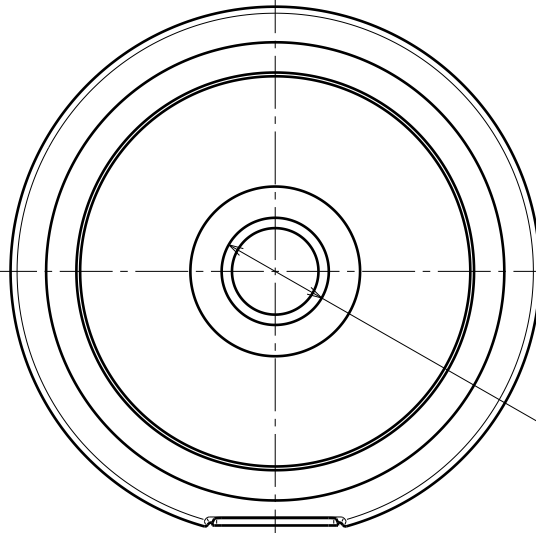

Bottom view

Ø 6.8

Ø 30.5

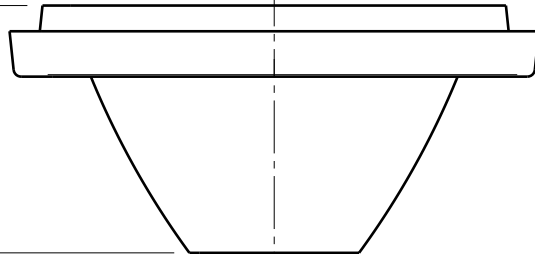

Side view

16.4

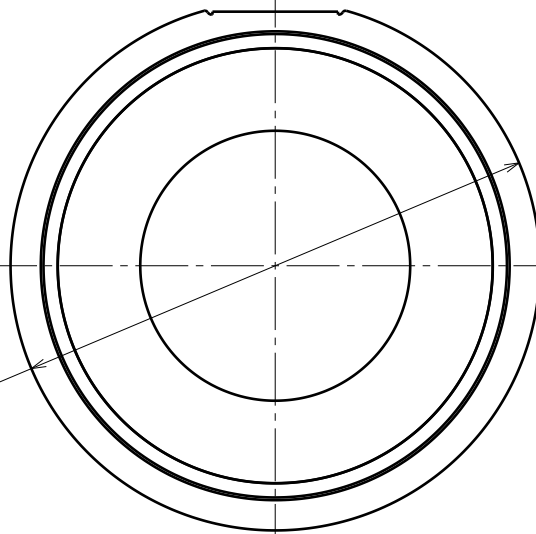

Top view

Ø 35

Tolerances if not otherwise shown:  
 According to DIN ISO 2768-1  
 Linear measures:  
 Up to 30mm class M, otherwise class C.

According to DIN ISO 2768-2  
 Form and position:  
 class L

Raw material(s):  
 PMMA 8N

This drawing is our property.  
 It can't be reproduced  
 or communicated without  
 our written agreement.



Ledil Oy  
 Salorankatu 10  
 24100 SALO  
 Finland

DRAWING TITLE

Datasheet Eva Spot Lens

DRAWN BY  
ah

DATE  
1.3.2013

CHECKED BY

DATE

SIZE  
A4

DRAWING NUMBER

C12041

REV  
1

DESIGNED BY  
HH

DATE  
26.08.2008

SCALE

2:1

WEIGHT (g)

SHEET

1/1

D

A

4

3

2

1

1



# Ledil CA12055\_Eva-S-XM-Tape CA12055\_Eva-S-XM-Tape / LDC (Linear)

Luminaire: Ledil CA12055\_Eva-S-XM-Tape CA12055\_Eva-S-XM-Tape  
Lamps: 1 x LED Module

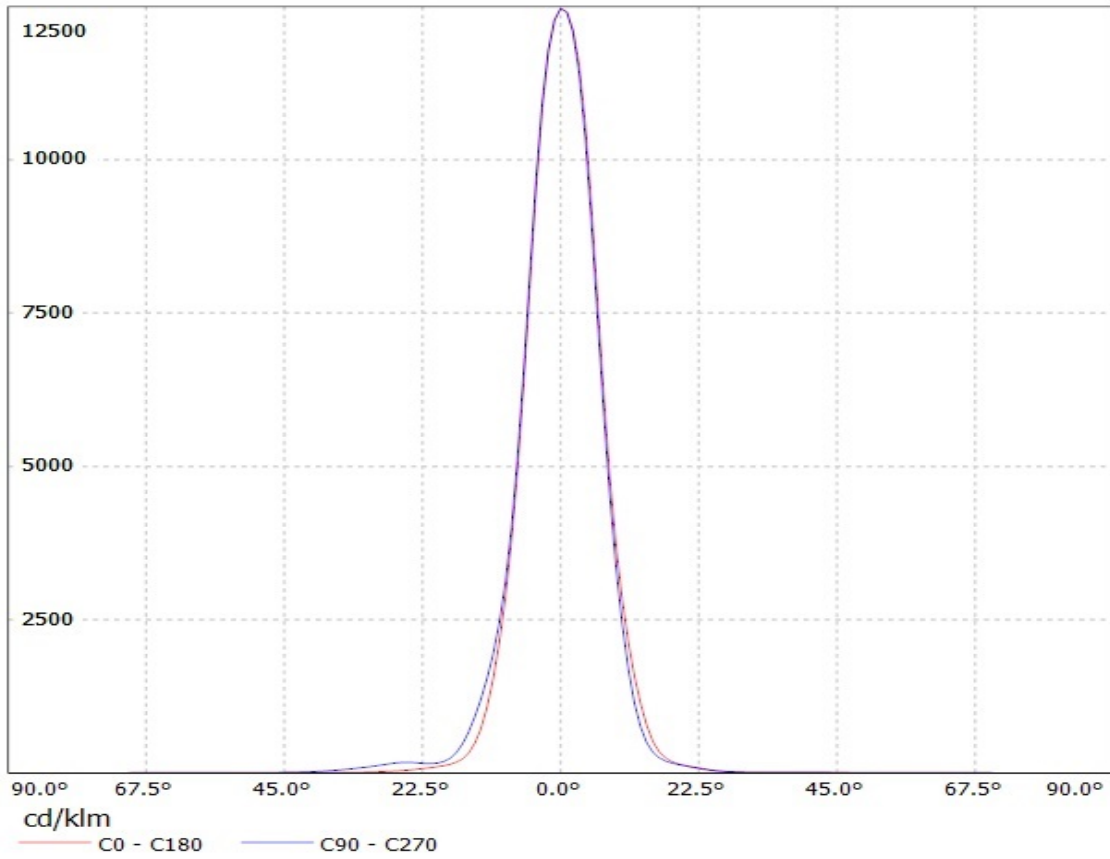

SIMULATED

Luminaire: LEDIL OY C12828\_EVA-O (XM-L) Efficiency=86%  
Lamps: 1 x Cree XM-L (111lm @ 250mA)

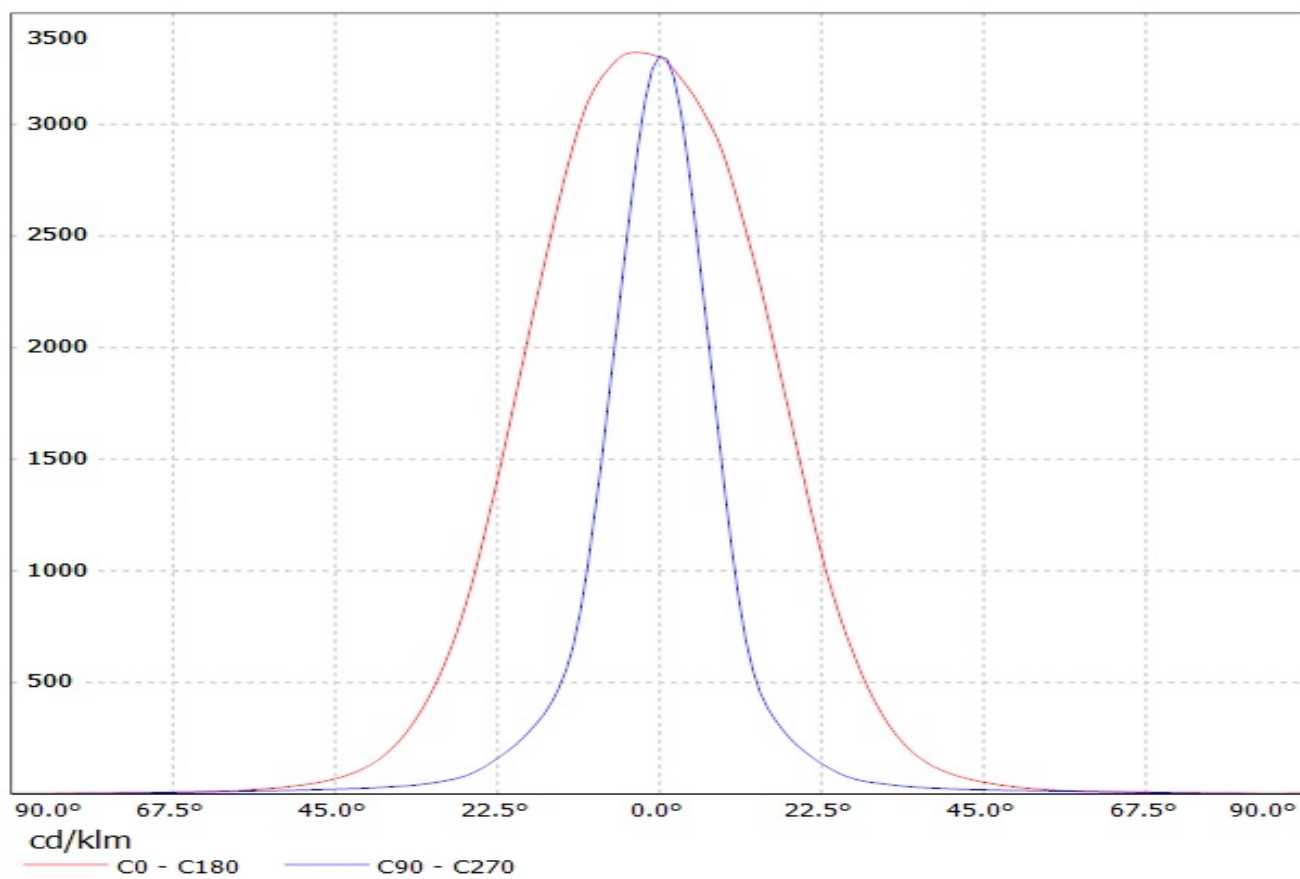

Luminaire: LEDIL OY CA12859\_EVA-O / CP12860\_EVA-O (XM-L) Efficiency=86%  
Lamps: 1 x Cree XM-L (111lm @ 250mA)

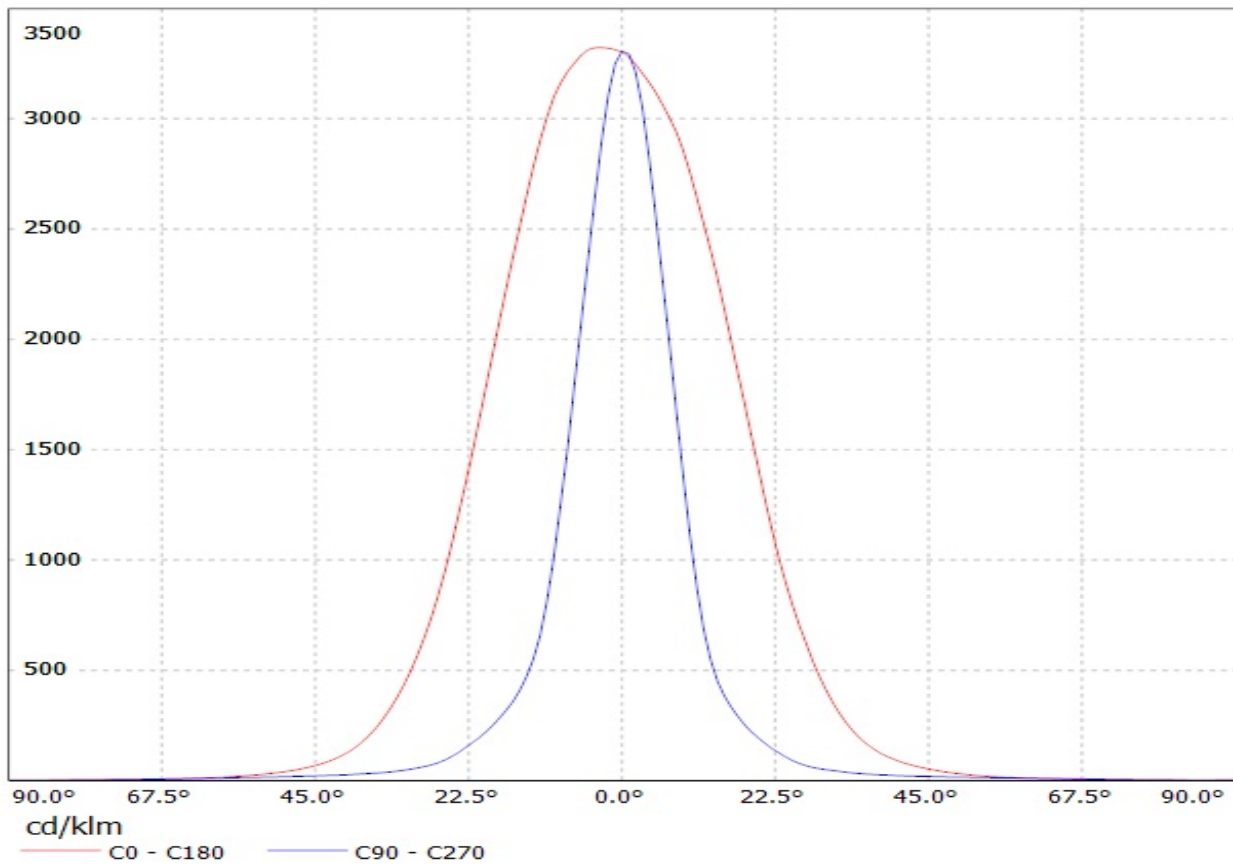

Luminaire: LEDIL OY CA12859\_EVA-O / CP12860\_EVA-O (XM-L) Efficiency=86%  
Lamps: 1 x Cree XM-L (111lm @ 250mA)

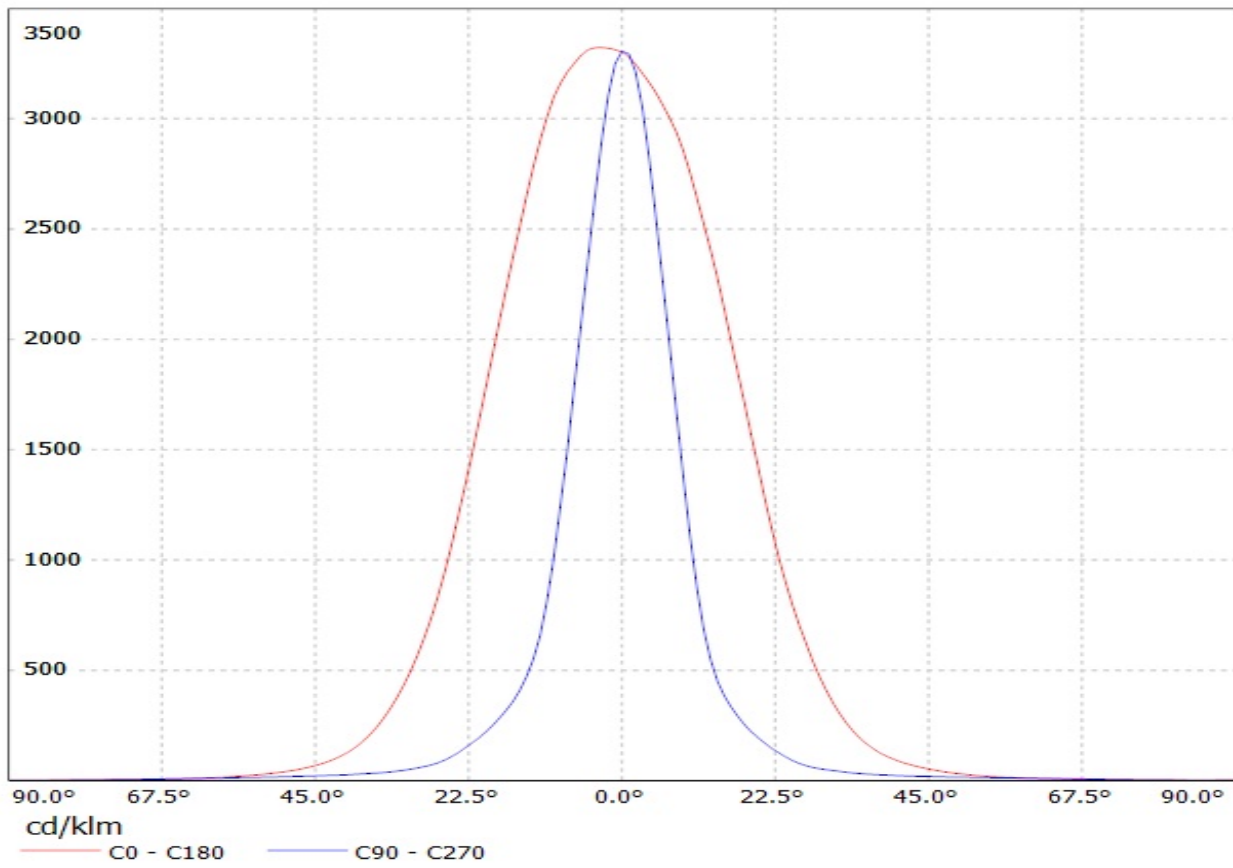

# Ledil CA12055\_Eva-S-XM-Tape CA12055\_Eva-S-XM-Tape / LDC (Linear)

Luminaire: Ledil CA12055\_Eva-S-XM-Tape CA12055\_Eva-S-XM-Tape  
Lamps: 1 x LED Module

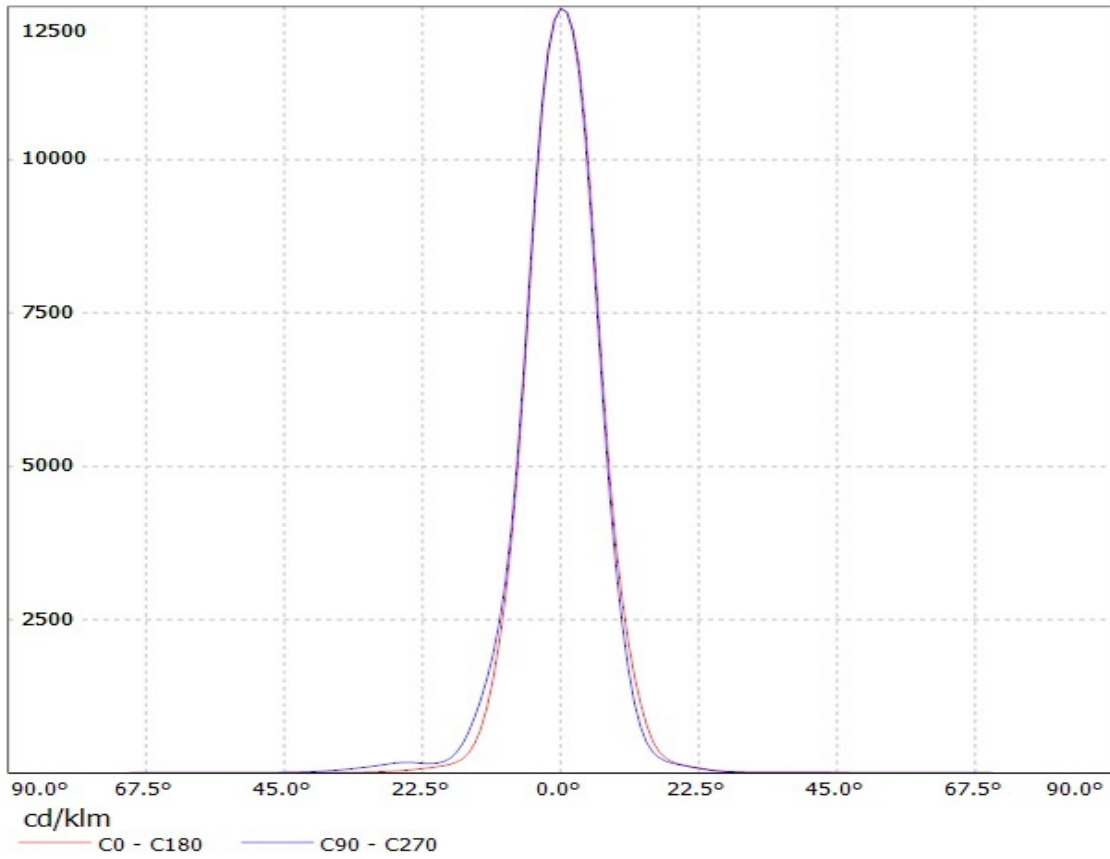

SIMULATED

# Ledil CA12055\_Eva-S-XM-Tape CA12055\_Eva-S-XM-Tape / LDC (Linear)

Luminaire: Ledil CA12055\_Eva-S-XM-Tape CA12055\_Eva-S-XM-Tape  
Lamps: 1 x LED Module

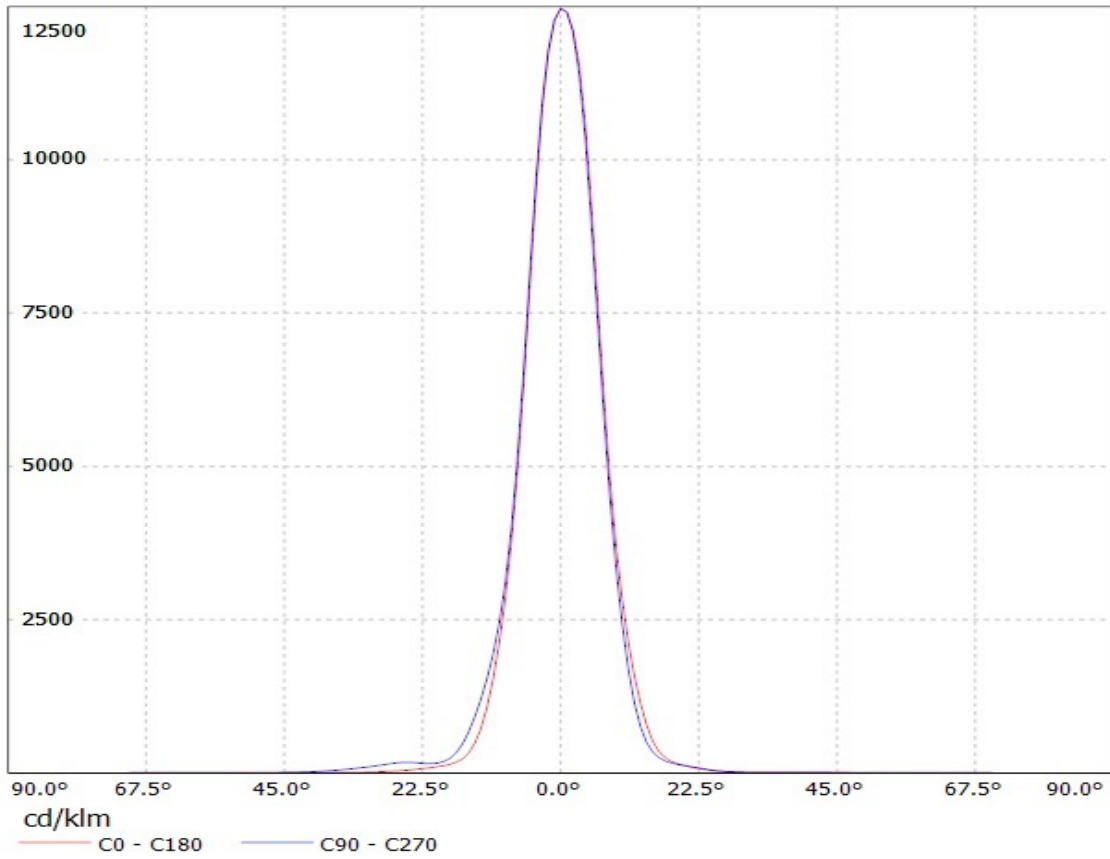

SIMULATED



# Ledil Oy CA12059\_Eva-W-XM-Tape CA12059\_Eva-W-XM-Tape / LDC (Linear)

Luminaire: Ledil Oy CA12059\_Eva-W-XM-Tape CA12059\_Eva-W-XM-Tape

Lamps: 1 x Cree XM-L white

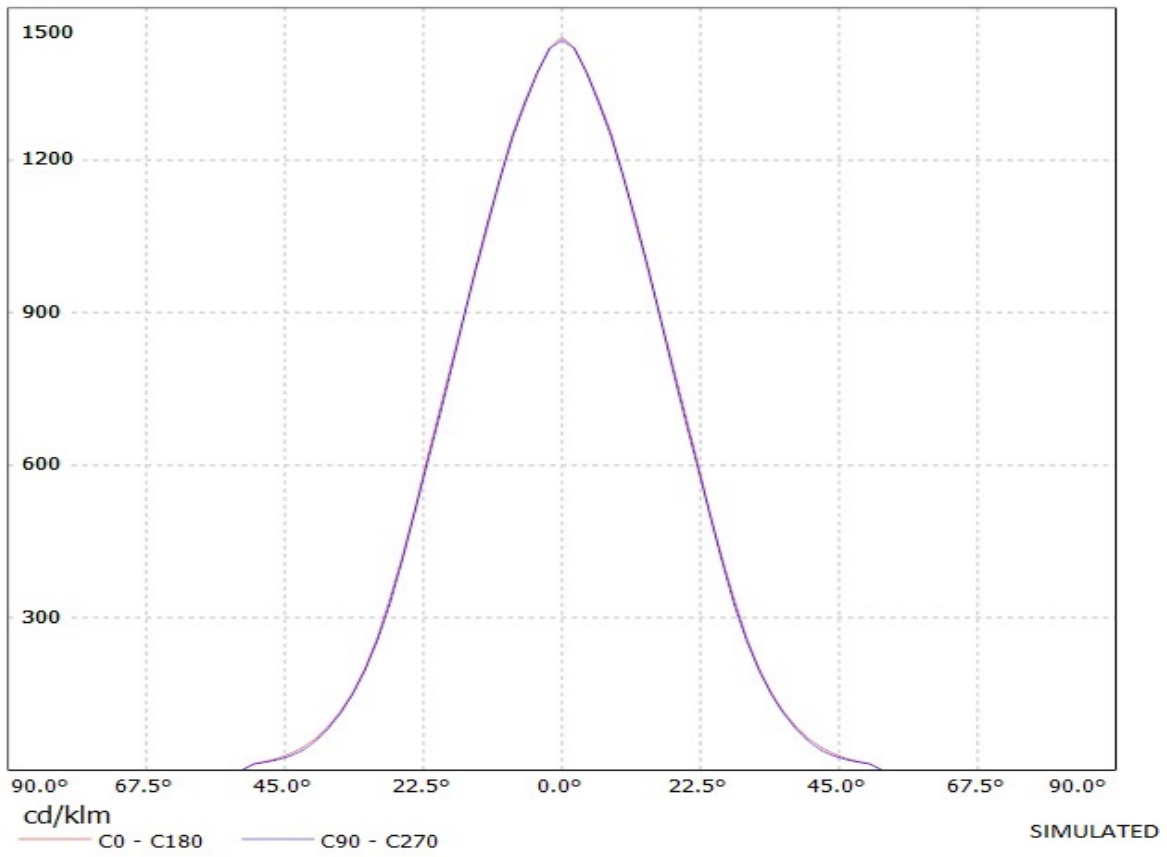

**Ledil Oy C10909\_CA12060\_Eva-WW-XM-Tape C10909\_CA12060\_Eva-WW-XM-Tape / LDC (Linear)**

Luminaire: Ledil Oy C10909\_CA12060\_Eva-WW-XM-Tape C10909\_CA12060\_Eva-WW-XM-Tape

Lamps: 1 x Cree XM-L

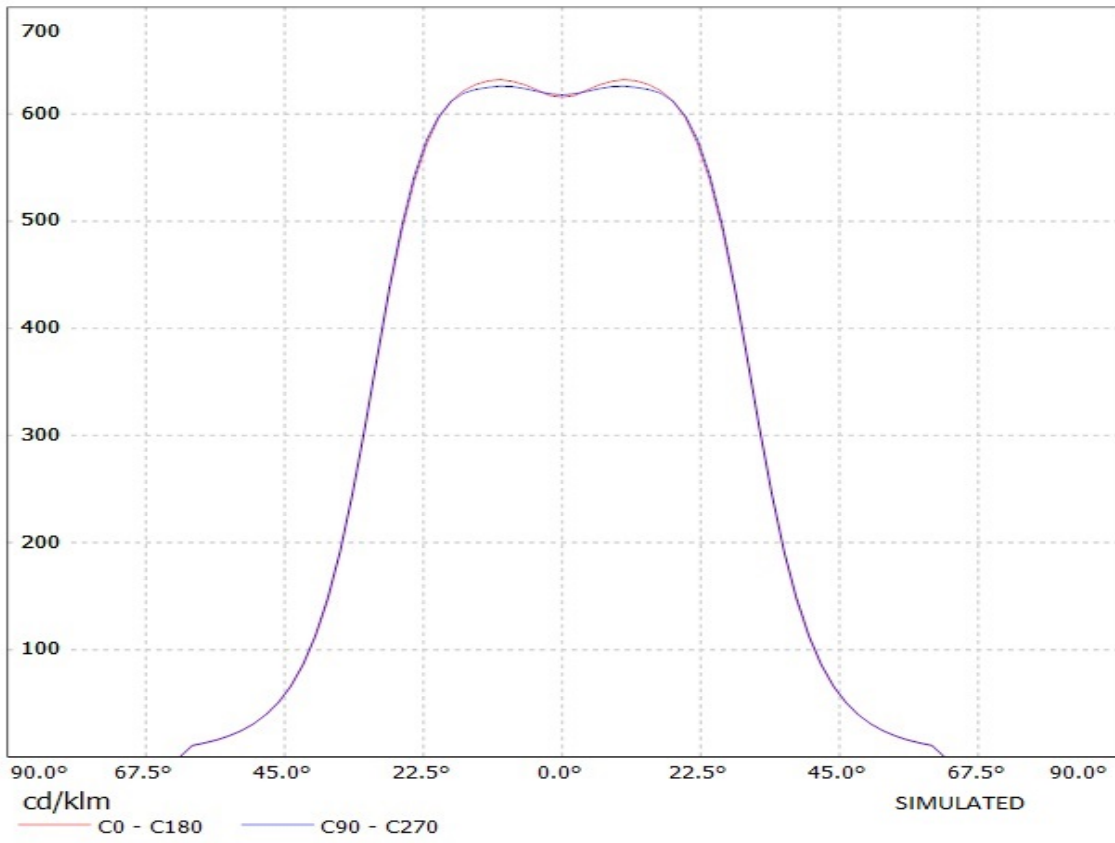

# Ledil CA12055\_Eva-S-XM-Tape CA12055\_Eva-S-XM-Tape / LDC (Polar)

Luminaire: Ledil CA12055\_Eva-S-XM-Tape CA12055\_Eva-S-XM-Tape

Lamps: 1 x LED Module

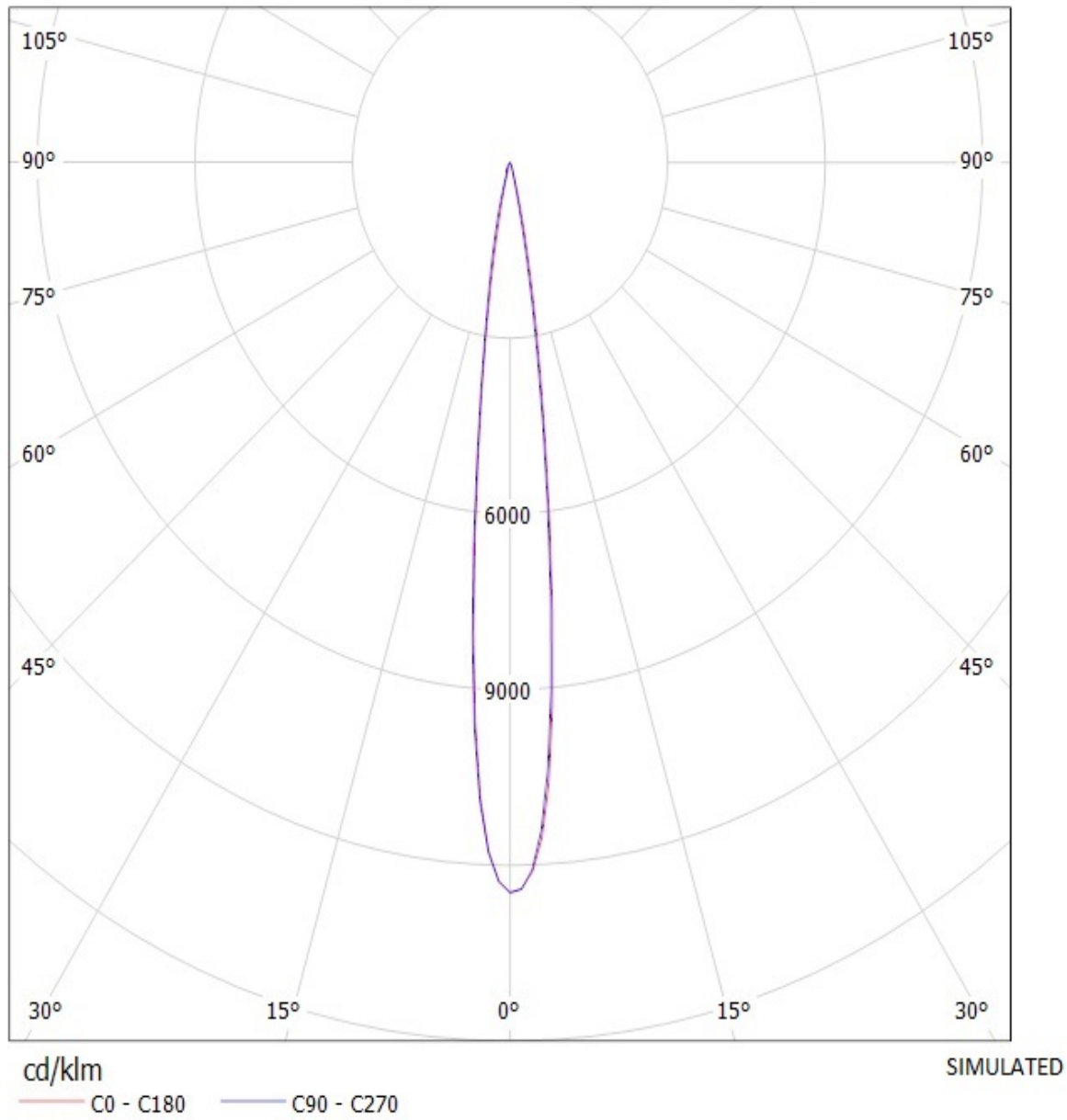

Luminaire: LEDIL OY C12828\_EVA-O (XM-L) Efficiency=86%  
Lamps: 1 x Cree XM-L (111lm @ 250mA)

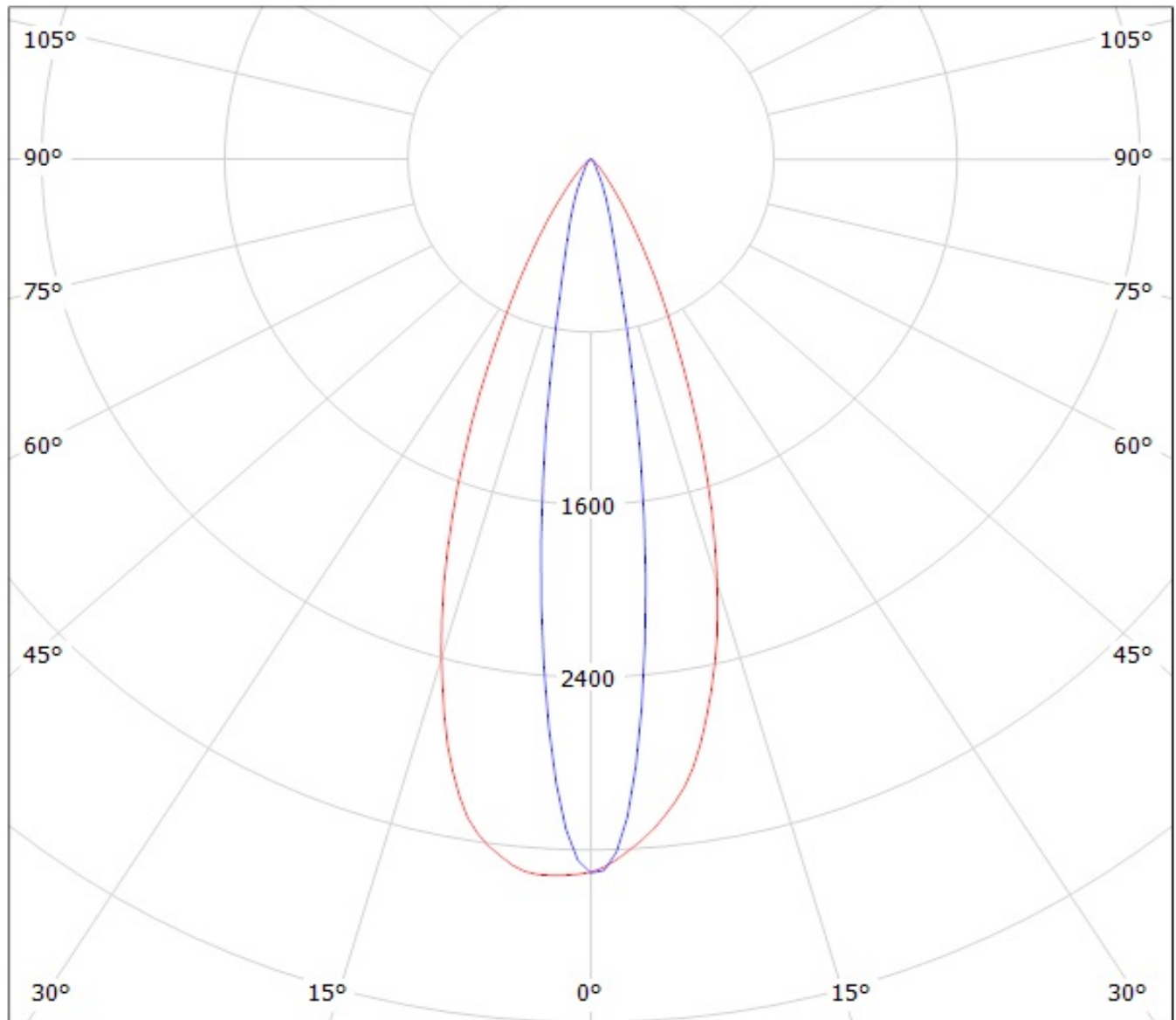

cd/klm

— C0 - C180

— C90 - C270

Luminaire: LEDIL OY CA12859\_EVA-O / CP12860\_EVA-O (XM-L) Efficiency=86%  
Lamps: 1 x Cree XM-L (1111lm @ 250mA)

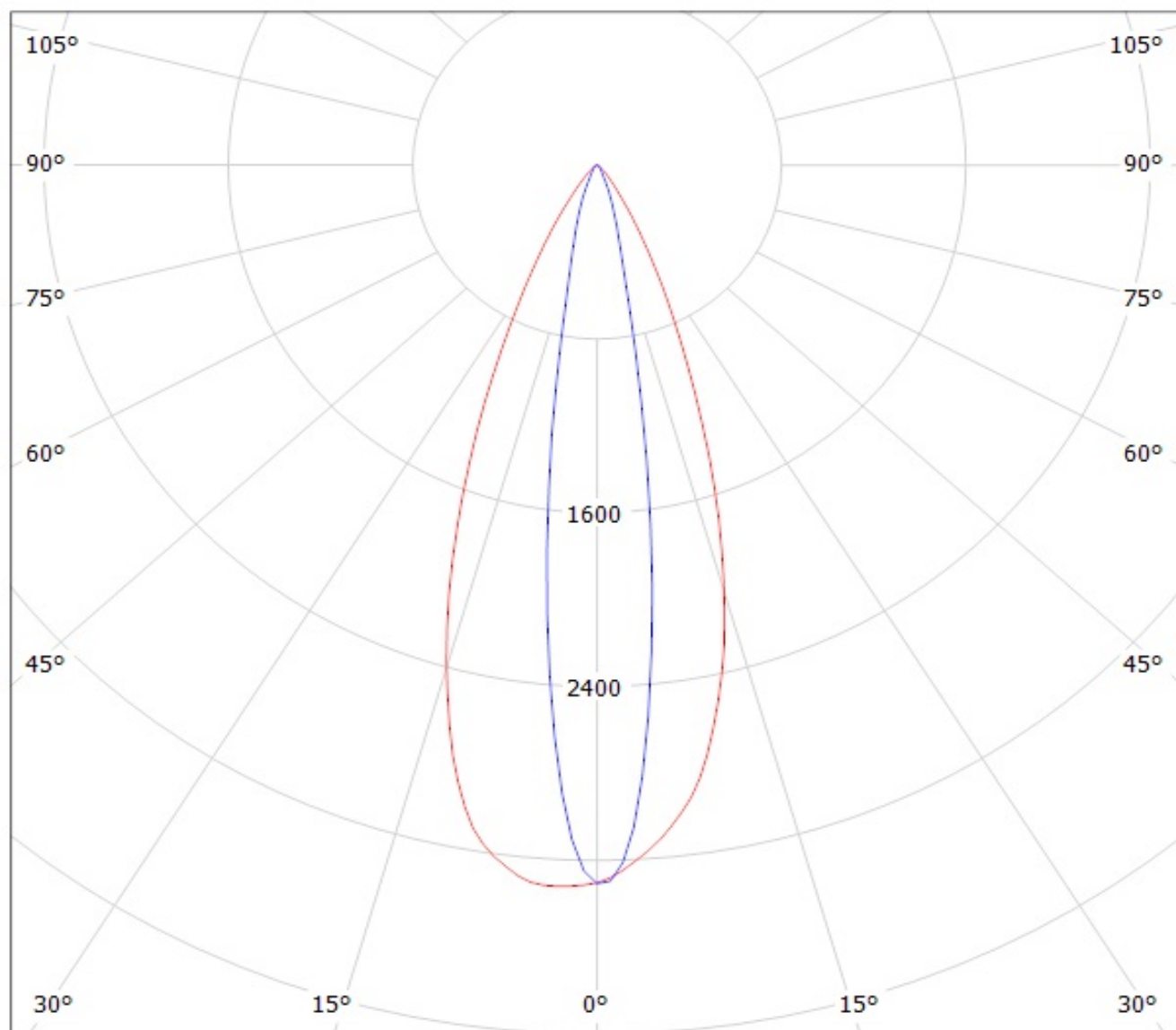

cd/klm

— C0 - C180

— C90 - C270

Luminaire: LEDIL OY CA12859\_EVA-O / CP12860\_EVA-O (XM-L) Efficiency=86%  
Lamps: 1 x Cree XM-L (1111lm @ 250mA)

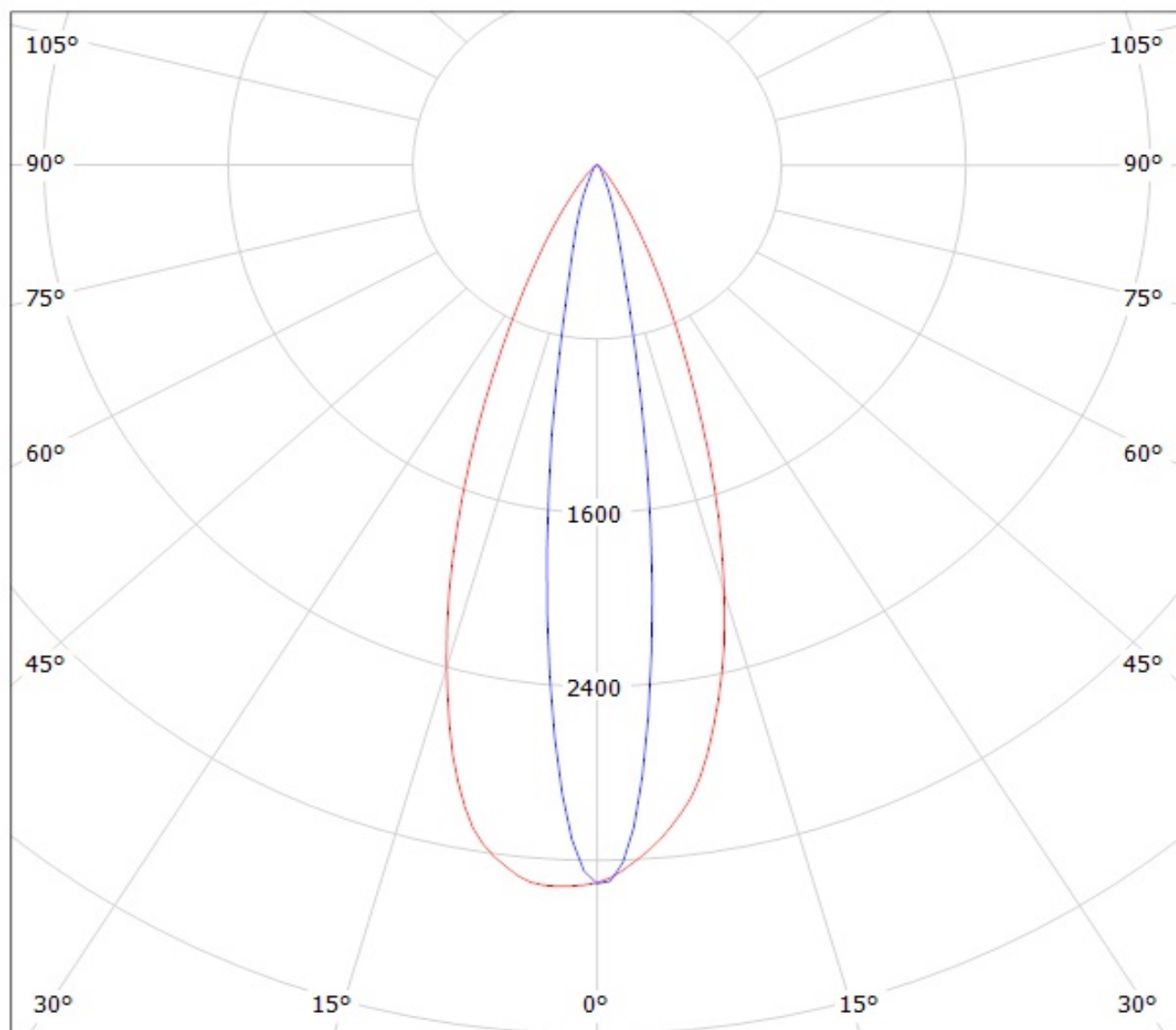

cd/klm

— C0 - C180

— C90 - C270



# Ledil CA12055\_Eva-S-XM-Tape CA12055\_Eva-S-XM-Tape / LDC (Polar)

Luminaire: Ledil CA12055\_Eva-S-XM-Tape CA12055\_Eva-S-XM-Tape

Lamps: 1 x LED Module

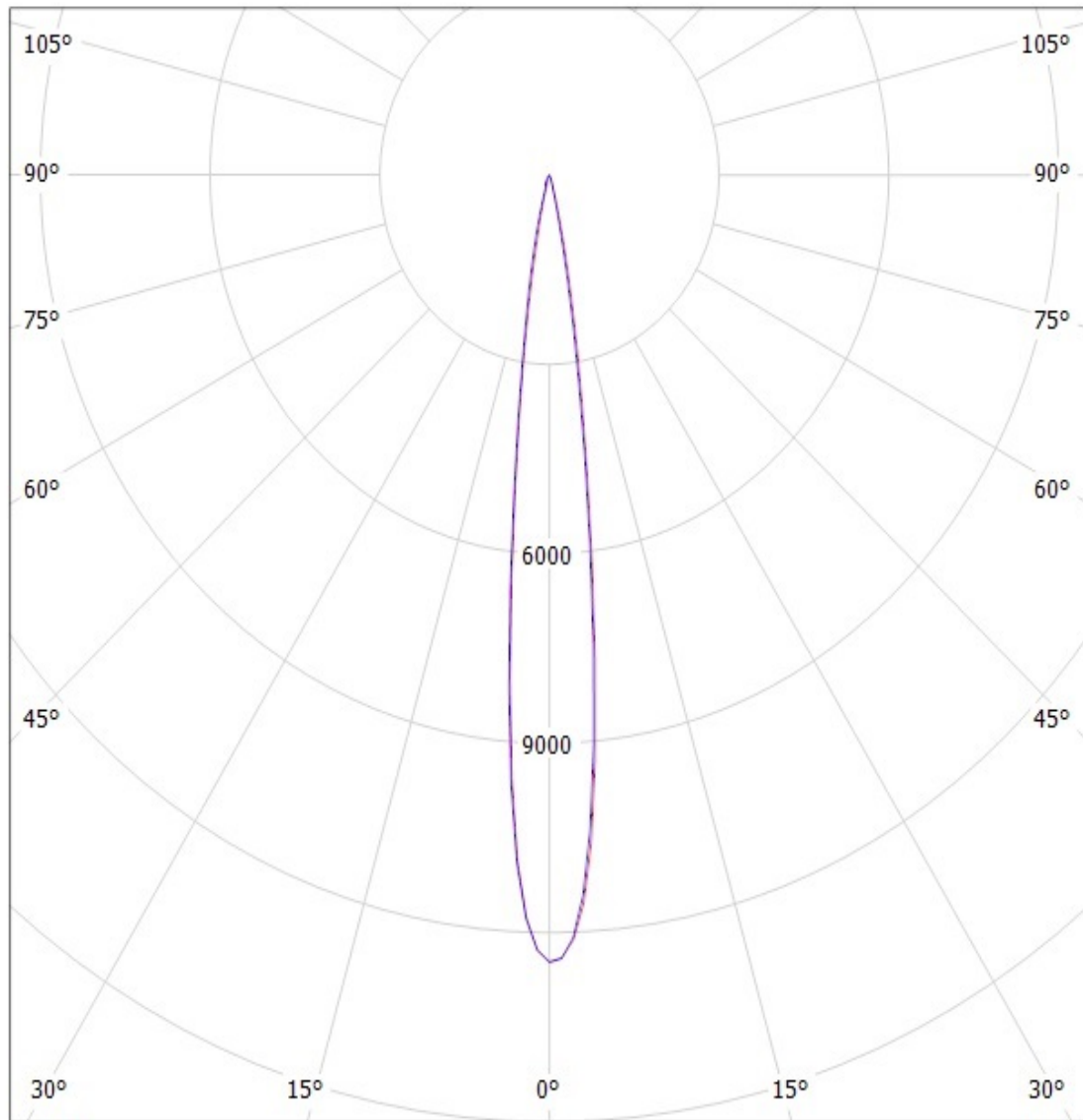

cd/klm

SIMULATED

— C0 - C180 — C90 - C270

# Ledil CA12055\_Eva-S-XM-Tape CA12055\_Eva-S-XM-Tape / LDC (Polar)

Luminaire: Ledil CA12055\_Eva-S-XM-Tape CA12055\_Eva-S-XM-Tape

Lamps: 1 x LED Module

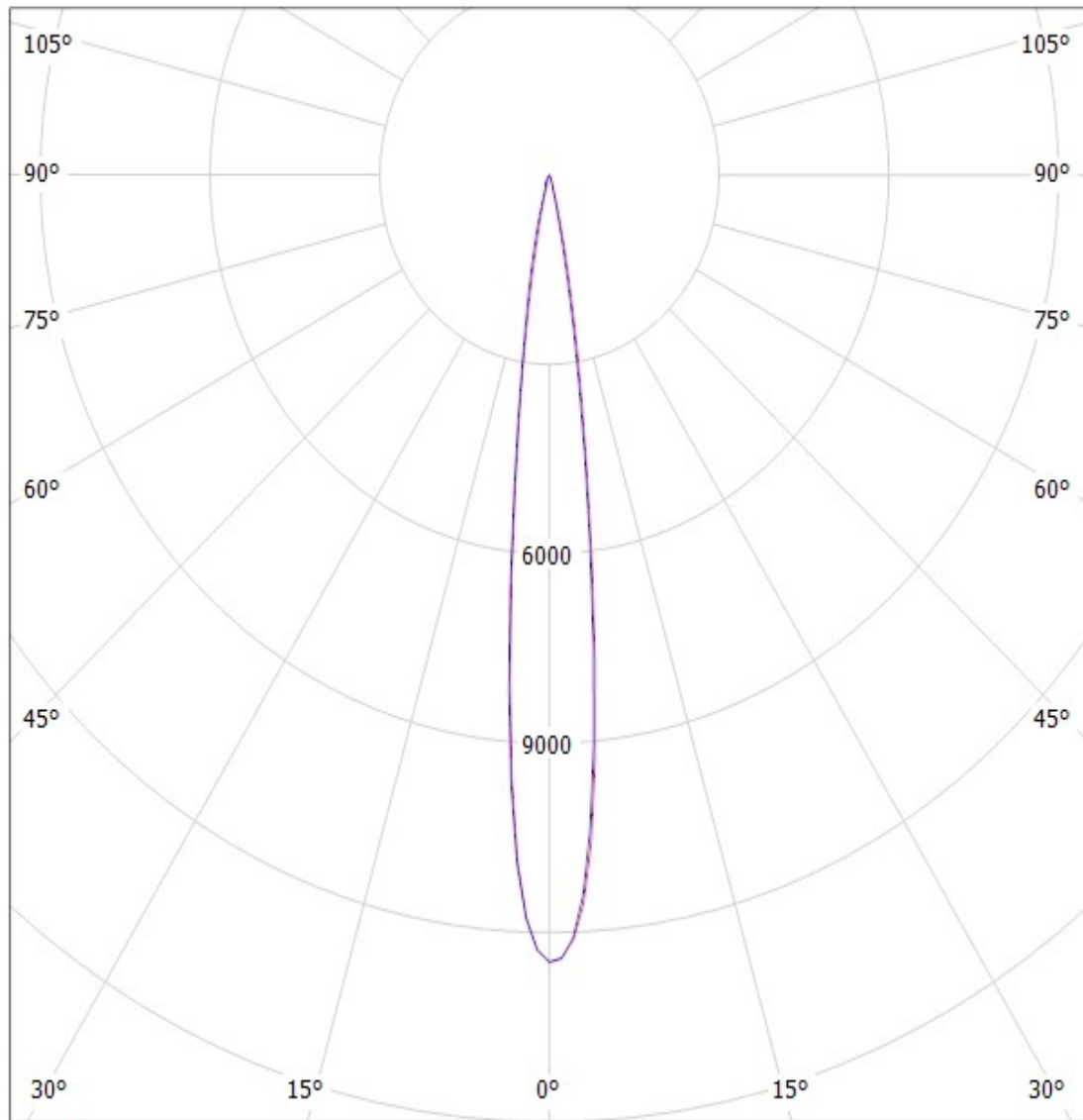

cd/klm

— C0 - C180 — C90 - C270

SIMULATED

# Ledil Oy CA12059\_Eva-W-XM-Tape CA12059\_Eva-W-XM-Tape / LDC (Polar)

Luminaire: Ledil Oy CA12059\_Eva-W-XM-Tape CA12059\_Eva-W-XM-Tape  
Lamps: 1 x Cree XM-L white

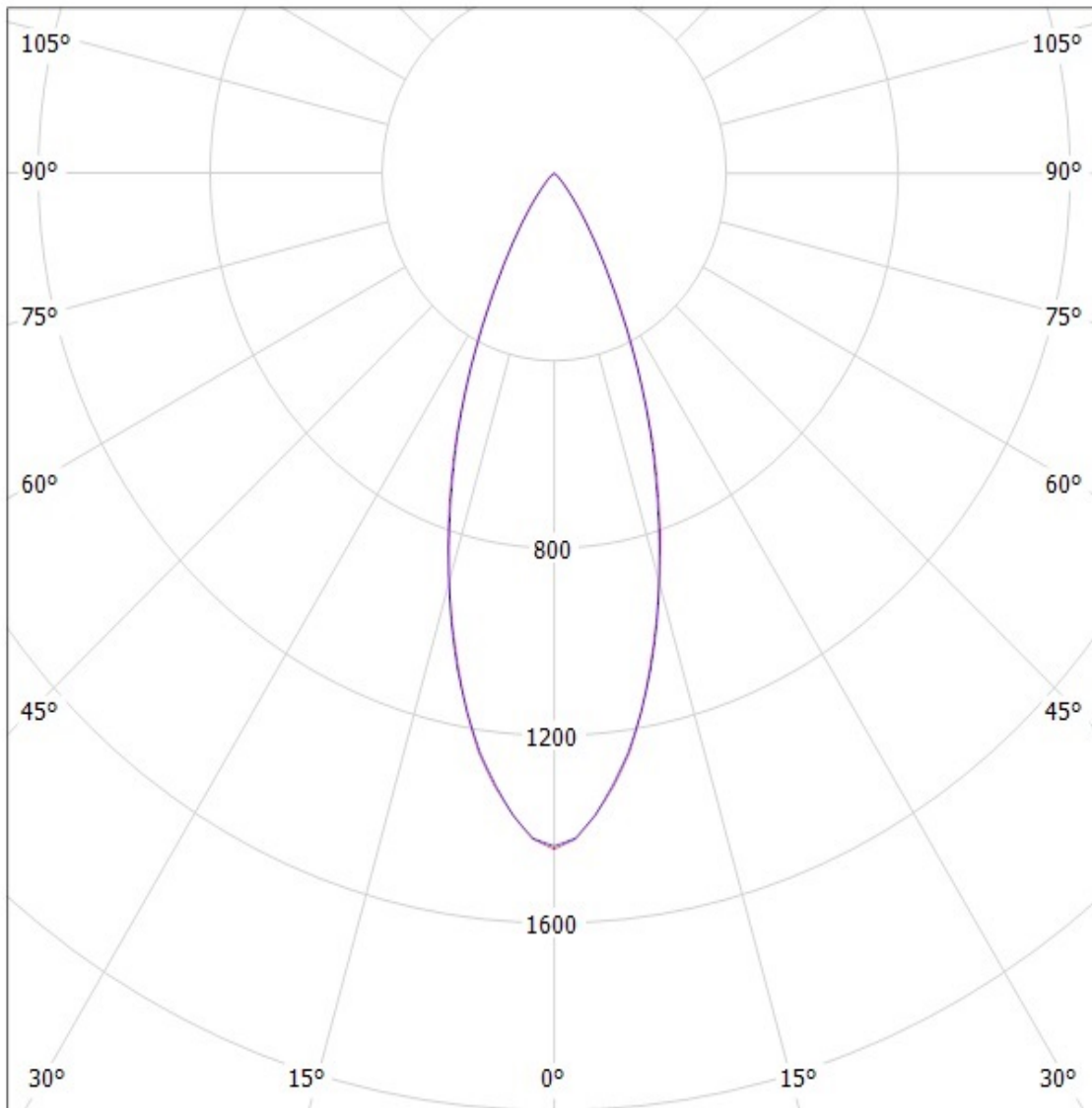

cd/klm

— C0 - C180

— C90 - C270

SIMULATED

# Ledil Oy C10909\_CA12060\_Eva-WW-XM-Tape C10909\_CA12060\_Eva-WW-XM-Tape / LDC (Polar)

Luminaire: Ledil Oy C10909\_CA12060\_Eva-WW-XM-Tape C10909\_CA12060\_Eva-WW-XM-Tape  
Lamps: 1 x Cree XM-L

