

# Solid State Relays 1-Phase with Integrated Heatsink Zero Cross or Instant On Switching Types RGC Solid State Contactor 'E' Connection



- Product width ranging from 17.5mm up to 70mm
- Ratings: up to 660 VAC, 85 AAC @ 40 °C
- 18000 A<sup>2</sup>s for the I<sup>2</sup>t and 1200 Vp blocking voltage
- Control voltages: 3-32 VDC, 20-275 VAC (24-190 VDC)
- Design according to EN/IEC60947-4-2, EN/IEC60947-4-3, EN/IEC62314, UL508, CSA 22-2 No. 14-13
- Conformance to Railway standards
- Integrated voltage transient protection with varistor
- 100 kA short circuit current rating according to UL508



## Product Description

This new range of solid state contactors presents a unique opportunity to maximize efficiency in panel space and is an evolution of solid state switches for which Carlo Gavazzi is very well known.

width is 17.5mm and is rated at 37 AAC. Power and control terminals allow for safe looping of cables.

Voltage transient protection is standard across the output with a varistor. Specifications are stated at 25°C unless otherwise noted.

The nominal current ratings are at 40°C. The smallest

## Ordering Key **RGC 1 A 60 A 30 K K E**

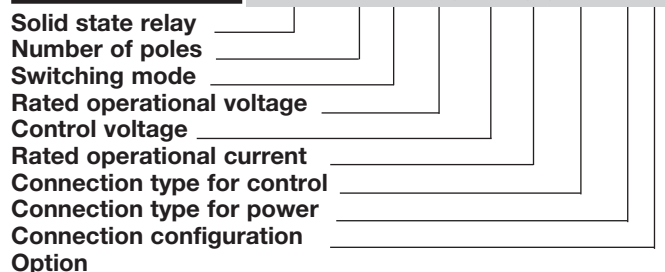

1. RGC..32 models are not VDE approved
2. Germanischer Lloyd approval applicable only to models RGC1....15.KE, RGC1...20.KE, RGC1...25..KE and RGC1....30.KE

## Ordering Key (Refer to page 2 and 3 for available part numbers)

1 Phase SSR with heatsink	Rated voltage, Blocking voltage	Control voltage	Rated current at 40°C <sup>3</sup>	Connection control	Connection power	Connection configuration	Option
<b>RGC1A: ZC<sup>4</sup></b>	23: 230V +10% - 15%, 800Vp	D: 3 or 4-32VDC	15: 20AAC, 525A <sup>2</sup> s	K: Screw	K: Screw	E: Contactor	P: Overtemperature protection (OTP) <sup>5</sup>
<b>RGC1B: IO<sup>4</sup></b>	60: 600V +10% -15%, 1200Vp	A: 20 - 275VAC, 24-190 VDC	20: 23AAC, 525A <sup>2</sup> s 25: 25AAC, 1800A <sup>2</sup> s 30: 30AAC, 1800A <sup>2</sup> s 32: 30 AAC, 18000A <sup>2</sup> s 40: 40AAC, 3200A <sup>2</sup> s 42: 43AAC, 18000A <sup>2</sup> s 60: 60AAC, 3200A <sup>2</sup> s 62: 65AAC, 18000A <sup>2</sup> s 90: 85AAC, 6600A <sup>2</sup> s 92: 85AAC, 18000A <sup>2</sup> s	G: Box clamp M: Pluggable spring-loaded	G: Box clamp		X20: Bulk packaging of 20 pcs. <sup>6</sup>

3. Refer to Derating Curves
4. ZC = Zero cross switching, IO= Instant ON switching
5. Default control connection for RGC...P is Box Clamp. See Connections Specifications
6. Applicable only to RGC..15, RGC..25 and RGC..32 models

## Selection Guide

Rated voltage, Blocking voltage, Switching mode	Control voltage	Connection control/power	Rated operational current @ 40°C (I <sup>2</sup> t value)				
			Product width				
			20 AAC (525A <sup>2</sup> s) 17.5mm, low depth	23 AAC (525A <sup>2</sup> s) 17.5mm	25 AAC (1800A <sup>2</sup> s) 17.5mm, low depth	30 AAC (1800A <sup>2</sup> s) 22.5mm	
230V, 800Vp ZC	3-32VDC	Screw/Screw	RGC1A23D15KKE	RGC1A23D20KKE	RGC1A23D25KKE	RGC1A23D30KKE	
		Spring/Screw	RGC1A23D15MKE	RGC1A23D20MKE	RGC1A23D25MKE	RGC1A23D30MKE	
	20-275VAC, 24-190VDC	Screw/Screw	RGC1A23A15KKE	RGC1A23A20KKE	RGC1A23A25KKE	RGC1A23A30KKE	
		Spring/Screw	RGC1A23A15MKE	RGC1A23A20MKE	RGC1A23A25MKE	RGC1A23A30MKE	
				<b>40 AAC (3200A<sup>2</sup>s)</b> 35mm	<b>43 AAC (18000A<sup>2</sup>s)</b> 35mm	<b>60 AAC (3200A<sup>2</sup>s)</b> 70mm	<b>65 AAC (18000A<sup>2</sup>s)</b> 70mm
	3-32VDC	Screw/Box	RGC1A23D40KGE	RGC1A23D42KGE	RGC1A23D60KGE	RGC1A23D62KGE	
		Screw/Box	RGC1A23A40KGE	RGC1A23A42KGE	RGC1A23A60KGE	RGC1A23A62KGE	
				<b>20 AAC (525A<sup>2</sup>s)</b> 17.5mm, low depth	<b>23 AAC (525A<sup>2</sup>s)</b> 17.5mm	<b>25 AAC (1800A<sup>2</sup>s)</b> 17.5mm, low depth	<b>30 AAC (1800A<sup>2</sup>s)</b> 22.5mm
	600V, 1200Vp ZC	4-32VDC	Screw/Screw	RGC1A60D15KKE	RGC1A60D20KKE	RGC1A60D25KKE	RGC1A60D30KKE
			Spring/Screw	RGC1A60D15MKE	RGC1A60D20MKE	RGC1A60D25MKE	RGC1A60D30MKE
20-275VAC, 24-190VDC		Screw/Screw	RGC1A60A15KKE	RGC1A60A20KKE	RGC1A60A25KKE	RGC1A60A30KKE	
		Spring/Screw	RGC1A60A15MKE	RGC1A60A20MKE	RGC1A60A25MKE	RGC1A60A30MKE	
			<b>30 AAC (18000A<sup>2</sup>s)</b> 17.5mm, low depth	<b>37 AAC (18000A<sup>2</sup>s)</b> 17.5mm, low depth			
4-32VDC		Screw/Screw	RGC1A60D32KKE	-			
		Spring/Screw	RGC1A60D32MKE	-			
		Screw/Box	-	RGC1A60D32KGE			
		Spring/Box	-	RGC1A60D32MGE			
			<b>40 AAC (3200A<sup>2</sup>s)</b> 35mm	<b>43 AAC (18000A<sup>2</sup>s)</b> 35mm	<b>60 AAC (3200A<sup>2</sup>s)</b> 70mm	<b>65 AAC (18000A<sup>2</sup>s)</b> 70mm	
4-32VDC	Screw/Box	RGC1A60D40KGE	RGC1A60D42KGE	RGC1A60D60KGE	RGC1A60D62KGE		
	Spring/Box	RGC1A60D40MGE	RGC1A60D42MGE	-	RGC1A60D62MGE		
20-275VAC, 24-190VDC	Screw/Box	RGC1A60A40KGE	RGC1A60A42KGE	RGC1A60A60KGE	RGC1A60A62KGE		
	Spring/Box	RGC1A60A40MGE	RGC1A60A42MGE	-	RGC1A60A62MGE		
			<b>20 AAC (525A<sup>2</sup>s)</b> 17.5mm, low depth	<b>23 AAC (525A<sup>2</sup>s)</b> 17.5mm	<b>25 AAC (1800A<sup>2</sup>s)</b> 17.5mm, low depth	<b>30 AAC (1800A<sup>2</sup>s)</b> 22.5mm	
600V, 1200Vp IO	4-32VDC	Screw/Screw	RGC1B60D15KKE	RGC1B60D20KKE	RGC1B60D25KKE	RGC1B60D30KKE	
					<b>40 AAC (3200A<sup>2</sup>s)</b> 35mm	<b>43 AAC (18000A<sup>2</sup>s)</b> 35mm	<b>60 AAC (3200A<sup>2</sup>s)</b> 70mm
	4-32VDC	Screw/Box	RGC1B60D40KGE	RGC1B60D42KGE	RGC1B60D60KGE	RGC1B60D62KGE	

## Selection Guide - RGC..P (Integrated Overtemperature Protection)

Rated voltage, Blocking voltage, Switching mode	Control voltage	Connection control / power	Rated operational current @ 40°C (I <sup>2</sup> t value)			
			Product width			
600V, 1200Vp ZC	5-32VDC 20-275VAC, 24-190VDC	Box/Screw Box/Screw	30 AAC (1800A <sup>2</sup> s) 22.5mm			
			RGC1A60D30GKEP RGC1A60A30GKEP			
			43 AAC (18000A <sup>2</sup> s) 35mm	65AAC (18000A <sup>2</sup> s) 70mm	85AAC (6600A <sup>2</sup> s) 70mm + fan	85AAC (18000A <sup>2</sup> s) 70mm + fan
	5-32VDC 20-275VAC, 24-190VDC	Box/Box Box/Box	RGC1A60D42GGEP RGC1A60A42GGEP	RGC1A60D62GGEP RGC1A60A62GGEP	RGC1A60D90GGEP RGC1A60A90GGEP	RGC1A60D92GGEP RGC1A60A92GGEP

## Selection Guide - RGC..X20 (RGC bulk packaging of 20 pcs.)

Rated voltage, Blocking voltage, Switching mode	Control voltage	Connection control / power	Rated operational current @ 40°C (I <sup>2</sup> t value)			
			Product width			
600V, 1200Vp ZC	4-32VDC	Screw/Screw	25 AAC (1800 A <sup>2</sup> s) 17.5 mm, low depth			
			RGC1A60D25KKEP RGC1A60D25KKEP			

## Output Voltage Specifications

	RGC..23..	RGC..60..
Operational voltage range	24-240 VAC, +10%, -15% on max	42-600 VAC, +10% -15% on max
Blocking voltage	800 Vp	1200 Vp
Internal varistor	275 V	625 V

## General Specifications

Latching voltage (across L1-T1)	20V	Rated impulse withstand	6 kV (1.2/50µs) for voltage, U <sub>imp</sub>
Operational frequency range	45 to 65Hz	Over-voltage category	III (fixed installations)
Power factor	> 0.5 @ V <sub>rated</sub>	Isolation	
Touch Protection	IP20	Input to Output RGC... RGC...D..P RGC...A..P	4000 Vrms 2500 Vrms 4000 Vrms
Control input status	continuously ON Green LED, when control input is applied	Input and Output RGC... to case RGC...D..P RGC...A..P	4000 Vrms 4000 Vrms 4000 Vrms
Pollution degree	2 (non-conductive pollution with possibilities of condensation)	Input to Fan/ Alarm Output RGC...A..P	2500 Vrms

## Output Specifications

	RGC..15..	RGC..20..	RGC..25..	RGC..30..	RGC..32..KE	RGC..32..GE
Rated operational current <sup>7</sup>						
AC-51 rating @ Ta=25°C	20 AAC	25.5 AAC	30 AAC	30 AAC	30 AAC	43 AAC
AC-51 rating @ Ta=40°C	20 AAC	23 AAC	25 AAC	30 AAC	30 AAC	37 AAC
AC-53a rating @ Ta=40°C	5 AAC	5 AAC	5 AAC	8 AAC	5 AAC	5 AAC
Number of motor starts per hour (x:6, Tx:6s, F:50%) at 40°C <sup>8</sup>	30	30	30	30	30	30
Min. operational current	150 mAAC	150 mAAC	250 mAAC	250 mAAC	500 mAAC	500 mAAC
Rep. overload current - (Motor Rating) PF = 0.4 - 0.5 UL508: T <sub>AMB</sub> =40°C, t <sub>ON</sub> =1s, t <sub>OFF</sub> =9s, 50 cycles	51 AAC	60 AAC	51 AAC	84 AAC	51 AAC	51 AAC
Maximum transient surge current (I <sub>TSM</sub> ), t=10ms	325 Ap	325 Ap	600 Ap	600 Ap	1900 Ap	1900 Ap
Maximum off-state leakage current at rated voltage	3 mAAC	3 mAAC	3 mAAC	3 mAAC	3 mAAC	3 mAAC
I <sup>2</sup> t for fusing (t=10ms), Minimum	525 A <sup>2</sup> s	525 A <sup>2</sup> s	1800 A <sup>2</sup> s	1800 A <sup>2</sup> s	18000 A <sup>2</sup> s	18000 A <sup>2</sup> s
Critical dv/dt (@ T <sub>j</sub> init = 40°C)	1000 V/μs	1000 V/μs	1000 V/μs	1000 V/μs	1000 V/μs	1000 V/μs

	RGC..40..	RGC..42..	RGC..60..	RGC..62..	RGC..90..	RGC..92..
Rated operational current <sup>7</sup>						
AC-51 rating @ Ta=25°C	47 AAC	50 AAC	70 AAC	75 AAC	85 AAC	85 AAC
AC-51 rating @ Ta=40°C	40 AAC	43 AAC	60 AAC	65 AAC	85 AAC	85 AAC
AC-53a rating @ Ta=40°C	13 AAC	16 AAC	14.8 AAC	20 AAC	18 AAC	20 AAC
Number of motor starts per hour (x:6, Tx:6s, F:50%) at 40°C <sup>8</sup>	30	30	30	30	30	30
Min. operational current	400 mAAC	500 mAAC	400 mAAC	500 mAAC	400 mAAC	500 mAAC
Rep. overload current - (Motor Rating) PF = 0.4 - 0.5 UL508: T <sub>AMB</sub> =40°C, t <sub>ON</sub> =1s, t <sub>OFF</sub> =9s, 50cycles	126 AAC	126 AAC	126 AAC	168 AAC	168 ACC	168 AAC
Maximum transient surge current (I <sub>TSM</sub> ), t=10ms	800 Ap	1900 Ap	800 Ap	1900 Ap	1150 Ap	1900 Ap
Maximum off-state leakage current at rated voltage	3 mAAC	3 mAAC	3 mAAC	3 mAAC	3 mAAC	3 mAAC
I <sup>2</sup> t for fusing (t=10ms), Minimum	3200 A <sup>2</sup> s	18000 A <sup>2</sup> s	3200 A <sup>2</sup> s	18000 A <sup>2</sup> s	6600 A <sup>2</sup> s	18000 A <sup>2</sup> s
Critical dv/dt (@ T <sub>j</sub> init = 40°C)	1000 V/μs	1000 V/μs	1000 V/μs	1000 V/μs	1000 V/μs	1000 V/μs

7. See Derating Curves

8. Overload profile for AC-53a;

le: AC-53a: x-Tx: F-S, where I<sub>e</sub> = nominal current (AC-53a AAC), x = overload current factor, Tx = duration of overload current (s), F = duty cycle (%), S = number of starts per hour. Example; 5A: AC-53a: 6 - 6 : 50 - 30 = max. 30 starts for the RGC..15 with an overload profile of 30A for 6 seconds with a duty cycle of 50%

## Overtemperature Alarm Specifications for RGC...P

	RGC..D..P	RGC..A..P
Output type	PNP open collector	Potential Free
Normal state	Closed	Closed
Maximum current rating	50 mADC	50 mADC
Rated voltage (EN61131-2: 2003) <sup>9, 10</sup> , U <sub>a</sub>	24VDC -15%, +20%	24VDC -15%, +20%
Rated voltage, U <sub>s</sub>	RGC...D9xGGEP 24VDC ± 10%	N/A
Fan rating, U <sub>f</sub>	RGC...A9xGGEP N/A	24VDC ±10%, 50mA nominal
Alarm voltage drop	Typical Maximum 2.8VDC 4VDC	1.8VDC 3.5VDC
Visual Indication	Continuous Red LED	Continuous Red LED
Reverse polarity protection	24VDC	24VDC

9. DC supply for alarm signal should be supplied from a Class 2 power source

10. Maximum voltage to be applied between 11+ and 12- (U<sub>a</sub>) terminals should be 35VDC maximum with reference to A2-

## Input Specifications

		RGC..D..	RGC..A..
Control voltage range <sup>11, 12</sup>	RGC..23..	3 - 32 VDC	20 - 275 VAC, 24 (-10%) - 190 VDC
	RGC..60..	4 - 32 VDC	20-275 VAC, 24 (-10%) - 190 VDC
	RGC...P (Uc)	5 - 32 VDC	20-275 VAC, 24 (-10%) - 190 VDC
Pick-up voltage	RGC..23..	3.0 VDC	20 VAC/DC
	RGC..60..	3.8 VDC	
	RGC...P	5 VDC	20 VAC/ 24VDC
Drop-out voltage		1 VDC	5 VAC/DC
Maximum Reverse voltage		32 VDC	-
Response time pick-up (RGC1A..)		0.5 cycle + 500µs @ 24VDC	2 cycles @ 230VAC/110VDC
Response time pick-up (RGC1B..)		350µs @ 24 VDC	N/A
Response time drop-out		0.5 cycle + 500µs @ 24VDC	0.5 cycle + 40ms @ 230VAC/110VDC
Input current @ 40°C		See diagrams below	See diagrams below

11. DC control to be supplied by class 2 power source according to UL1310

12. For GL approved models control range for RGC1.23... is 4-32VDC and for RGC1.60... 5-32VDC

### RG..A..

RGC1 .. A : Input current vs input voltage

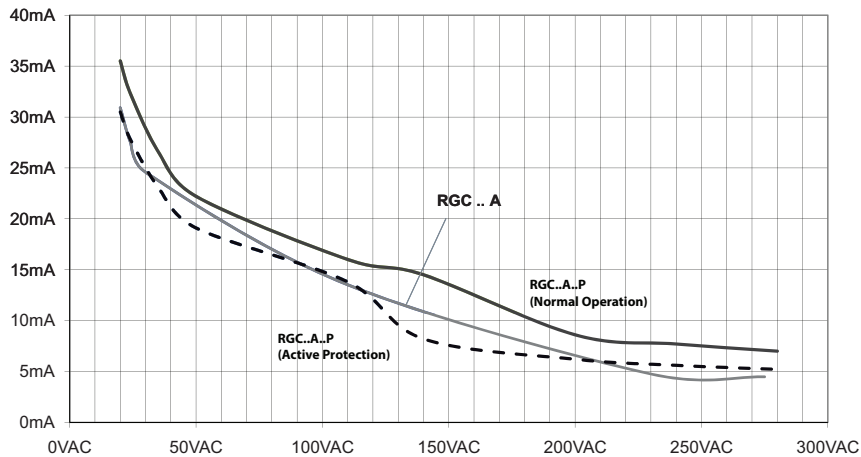

RGC1 .. A : Input current vs input voltage

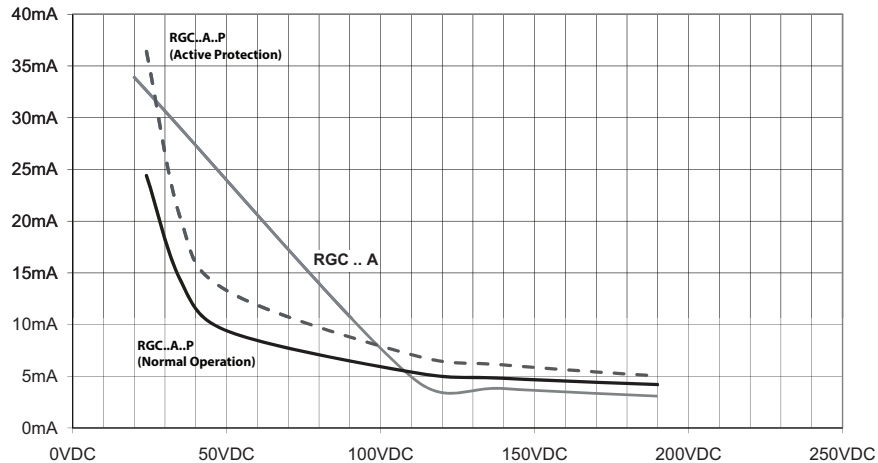

## Input Specifications (cont.)

RG..D..

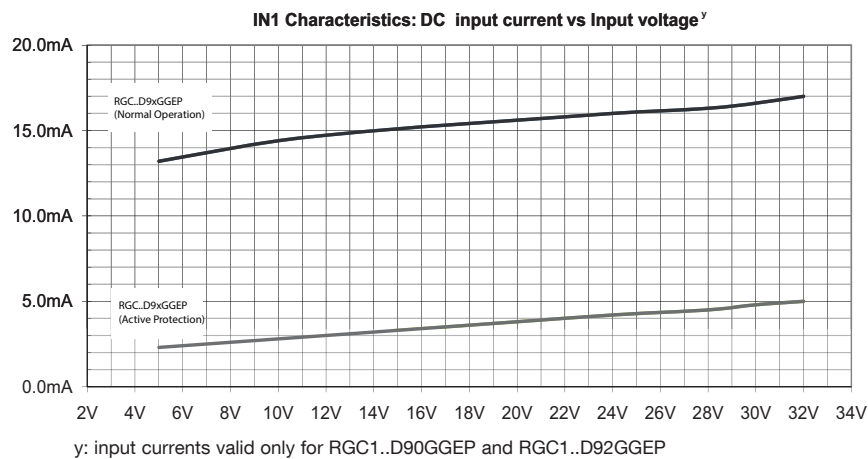
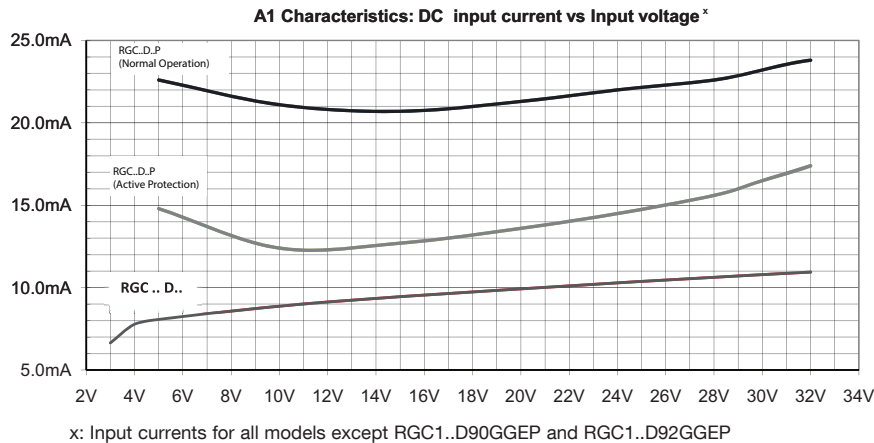

## Motor Ratings: HP (UL508) / kW (EN/IEC60947-4-2) @ 40°C

	115 VAC	230 VAC	400 VAC	480 VAC	600 VAC
RGC..15	1/3HP / 0.18kW	1HP / 0.37kW	2HP / 0.75kW	3HP / 1.1kW	3HP / 1.5kW
RGC..20	1/2HP / 0.18kW	1 1/2HP / 0.37kW	2HP / 0.75kW	3HP / 1.1kW	3HP / 1.5kW
RGC..25	1/3HP / 0.18kW	1HP / 0.37kW	2HP / 0.75kW	3HP / 1.1kW	3HP / 1.5kW
RGC..30	3/4HP / 0.37kW	2HP / 1.1kW	3HP / 1.5kW	5HP / 2.2kW	5HP / 3.7kW
RGC..32	1/3HP / 0.18kW	1HP / 0.37kW	2HP / 0.75kW	3HP / 1.1kW	3HP / 1.5kW
RGC..40	1HP / 0.56kW	3HP / 1.5kW	5HP / 2.2kW	5HP / 3.7kW	7 1/2HP / 4kW
RGC..42	1 1/2HP / 0.56kW	3HP / 1.5kW	5HP / 2.2kW	7 1/2HP / 3.7kW	10HP / 4kW
RGC..60	1 1/2HP / 0.56kW	3HP / 1.5kW	5HP / 3kW	7 1/2HP / 4kW	10HP / 4kW
RGC..62	2HP / 0.75kW	5HP / 1.5kW	7 1/2HP / 4kW	10HP / 4kW	15HP / 5.5kW
RGC..90	2HP / 0.75kW	5HP / 1.5kW	7 1/2HP / 4kW	10HP / 4kW	15HP / 5.5kW
RGC..92	2HP / 0.75kW	5HP / 1.5kW	7 1/2HP / 4kW	10HP / 4kW	15HP / 5.5kW

## Detailed Over temperature Alarm Procedure (for RGC...P)

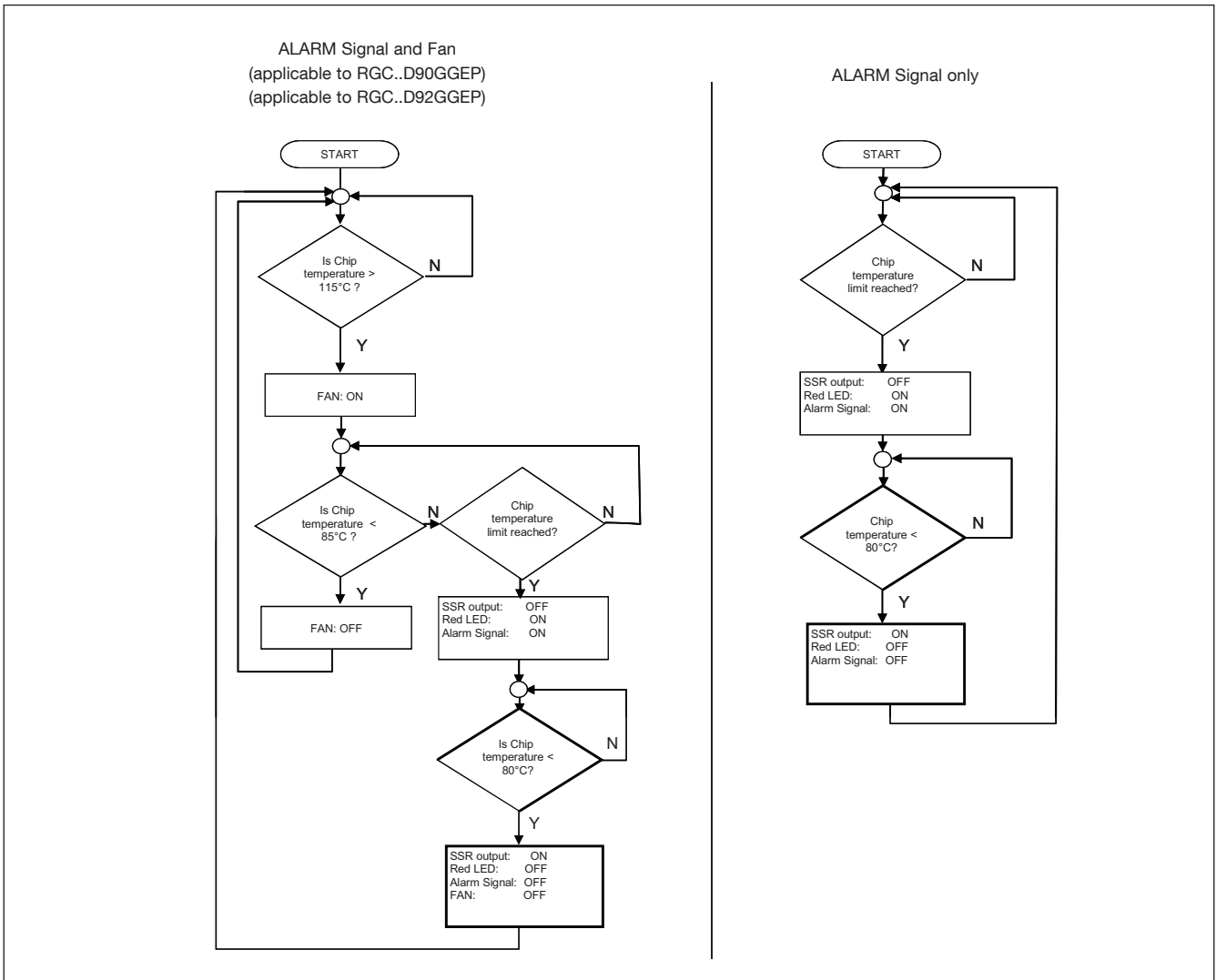

**CAUTION**

- Alarm condition resets whenever the voltage signal is removed from terminal A1 (+)
- In the case of RGC1A60D9xGGEP, if the voltage signal is not applied across A1(+) and A2 (-) terminals, the overtemperature detection and functionality is lost (including fan operation and alarm signalling)
- In the case of RGC1A60A9xGGEP it is necessary to supply IN2 and IN3 with 24VDC for fan operation.
- Alarm procedure for RGC1A60A9xGGEP follows 'Alarm signal only' flow since fan is continuously operating.
- Alarm condition automatically resets ONLY when power semiconductor temperature < 80°C
- Temperatures indicated are typical figures.

## Output Power Dissipation

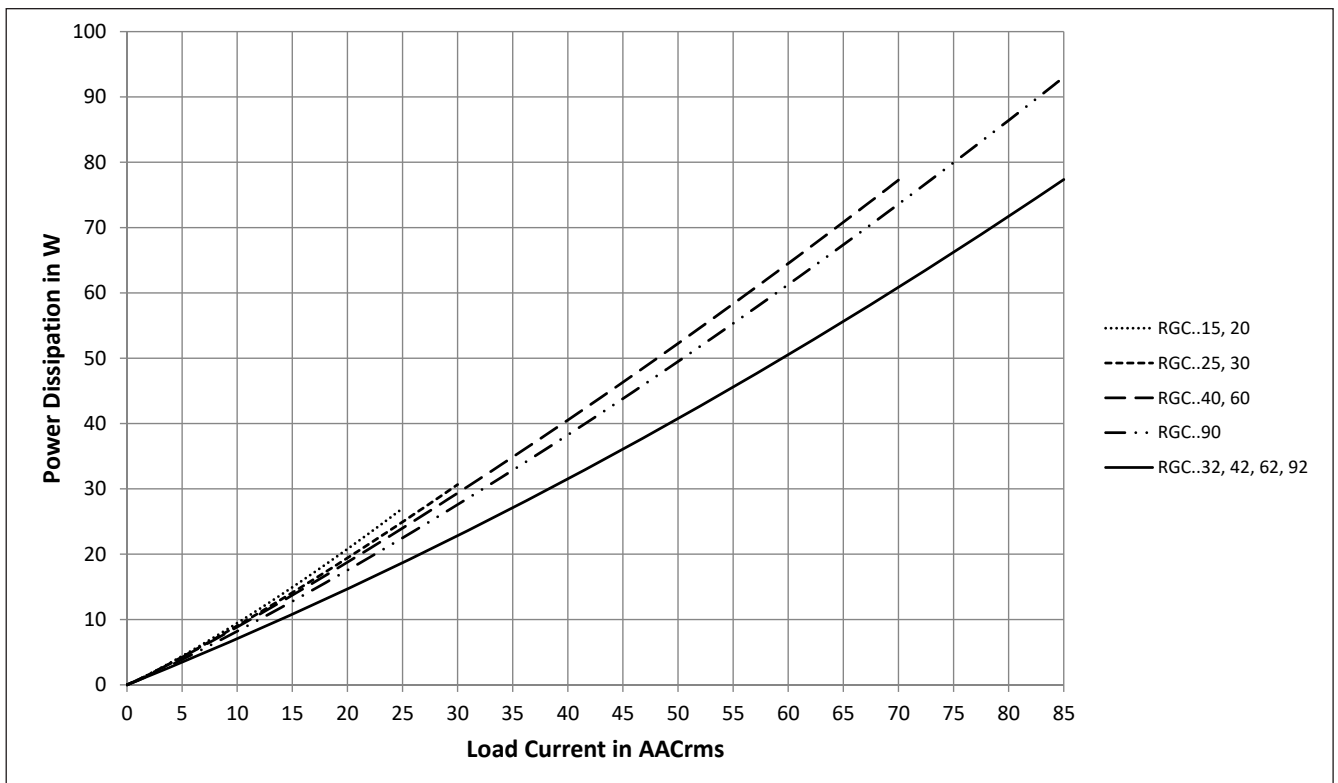



## Current Derating (UL508)

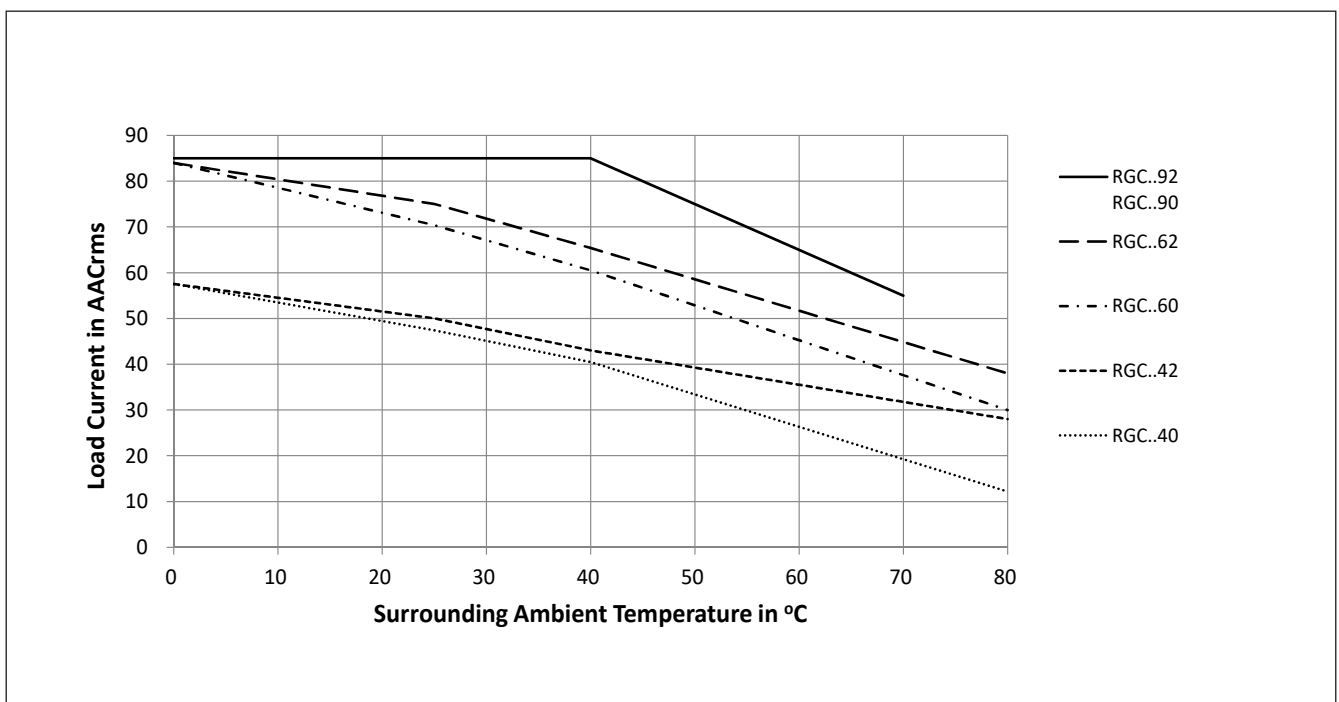
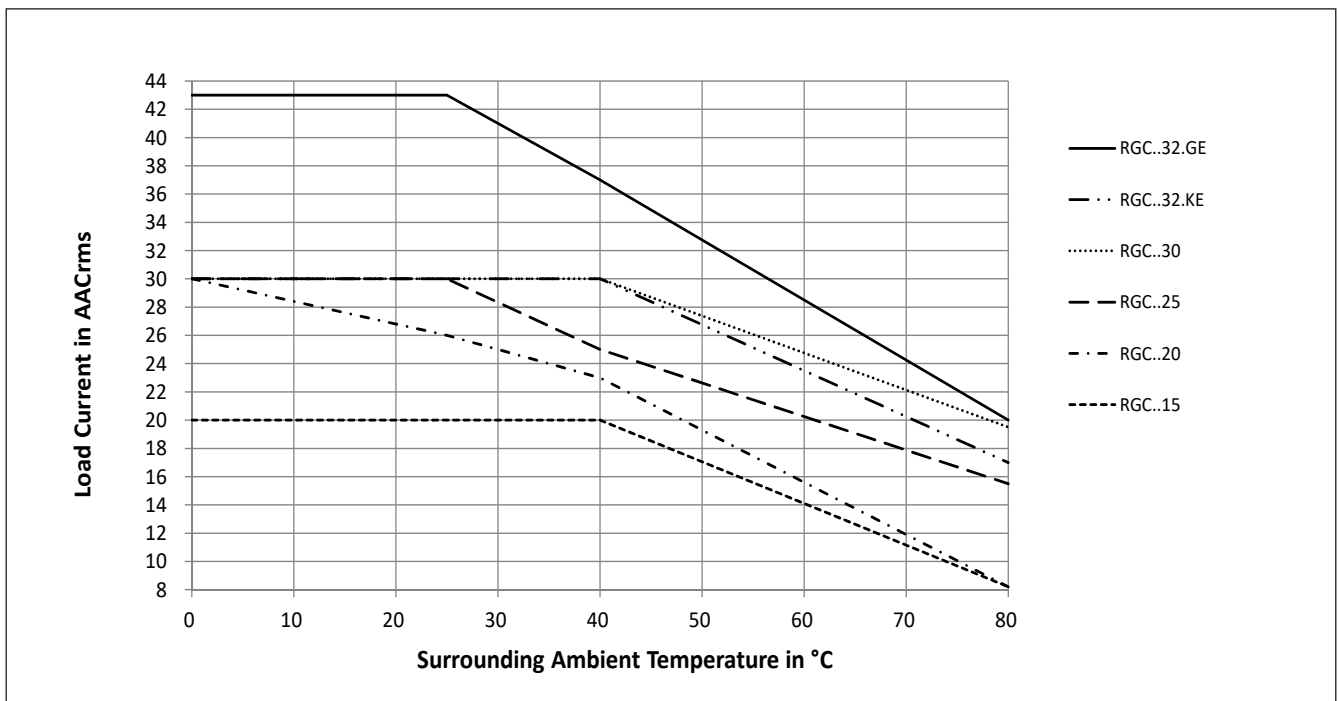

RGC...P models max. operating temperature is + 70°C

## Derating vs. Spacing Curves

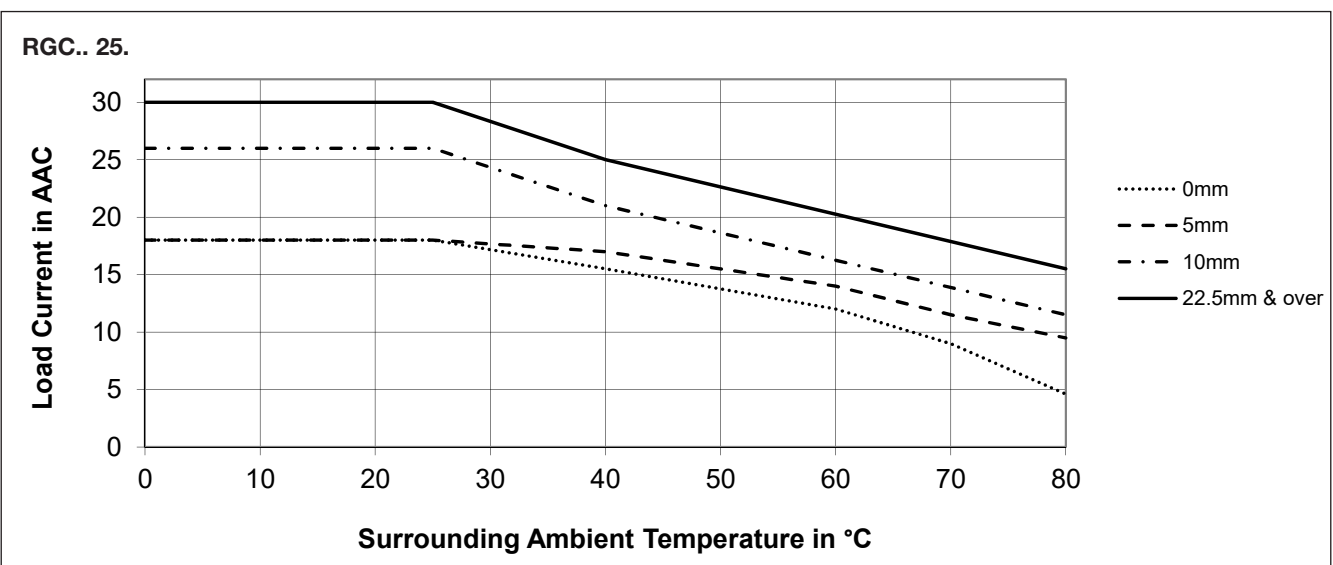
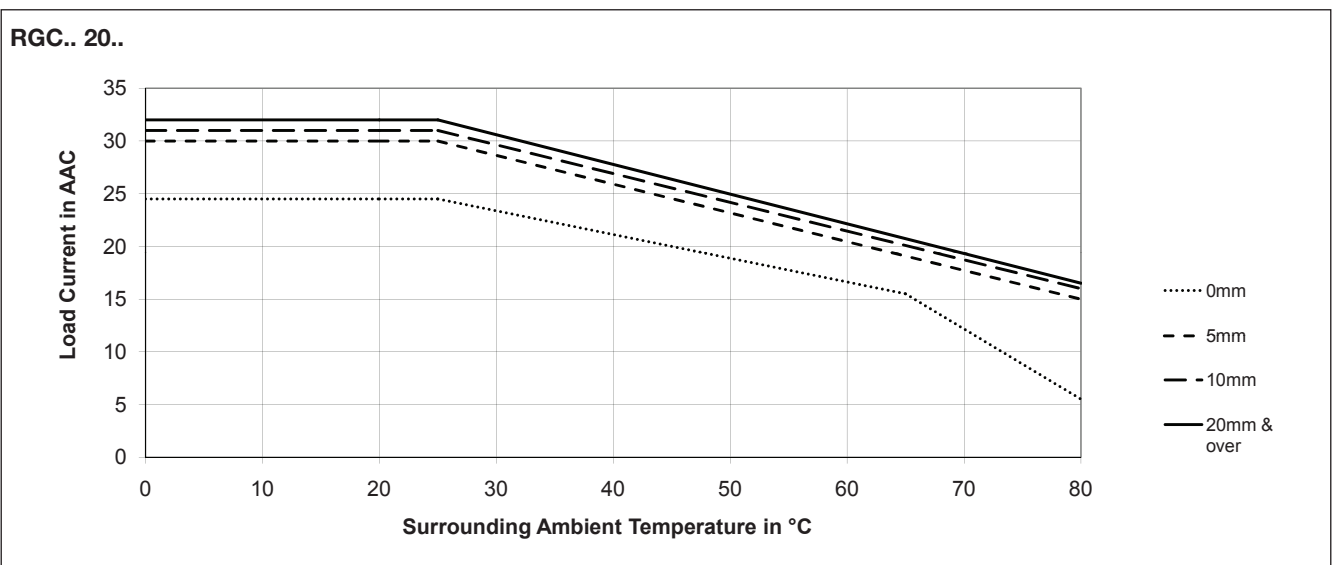
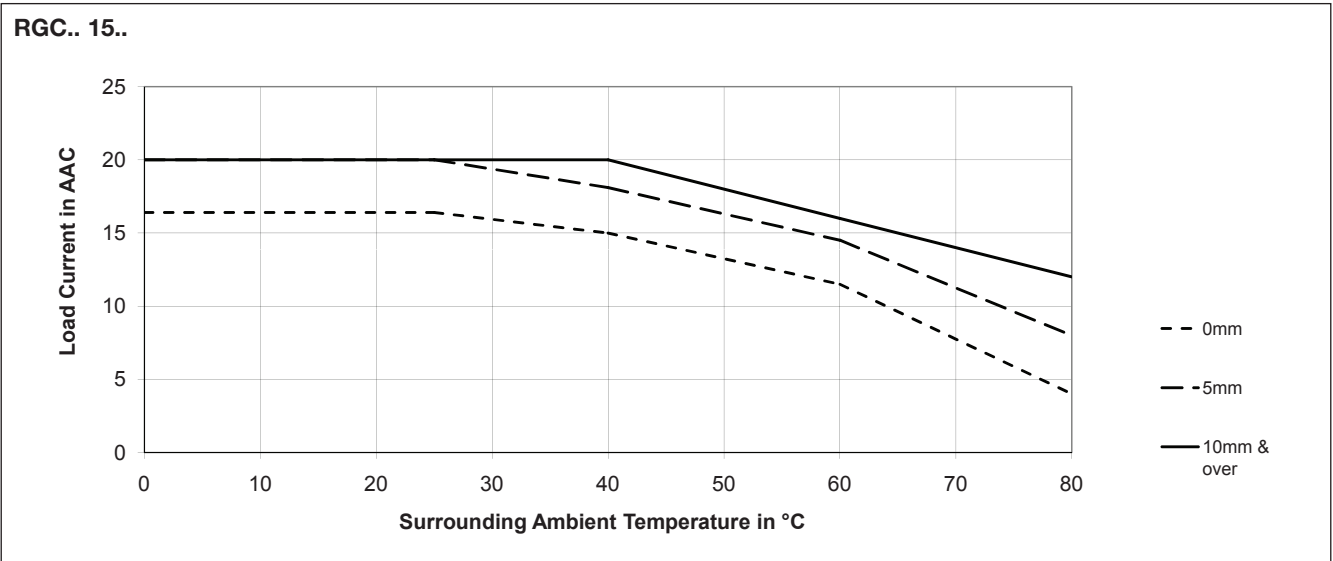

## Derating vs. Spacing Curves

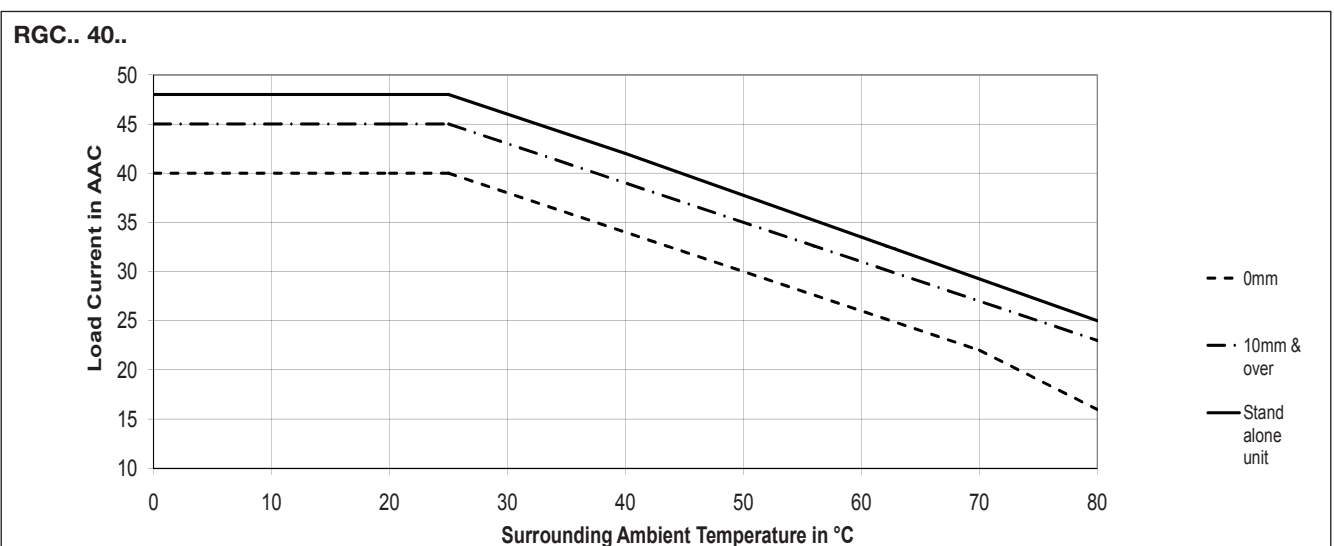
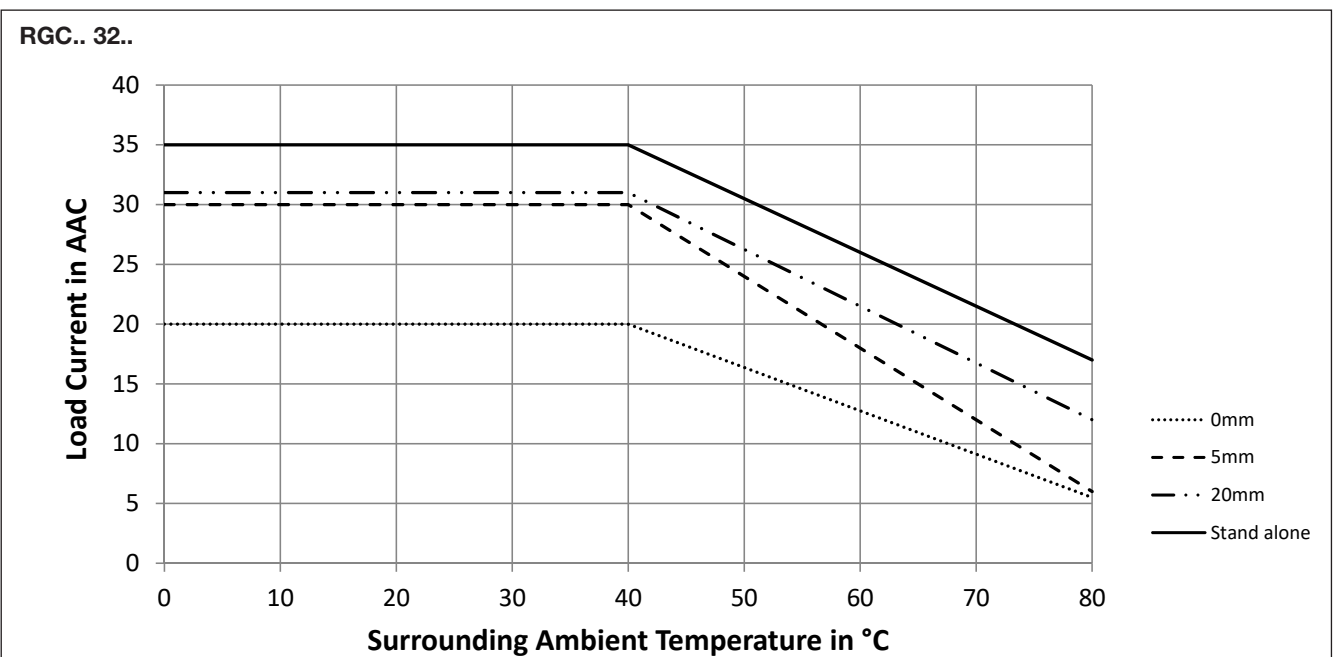
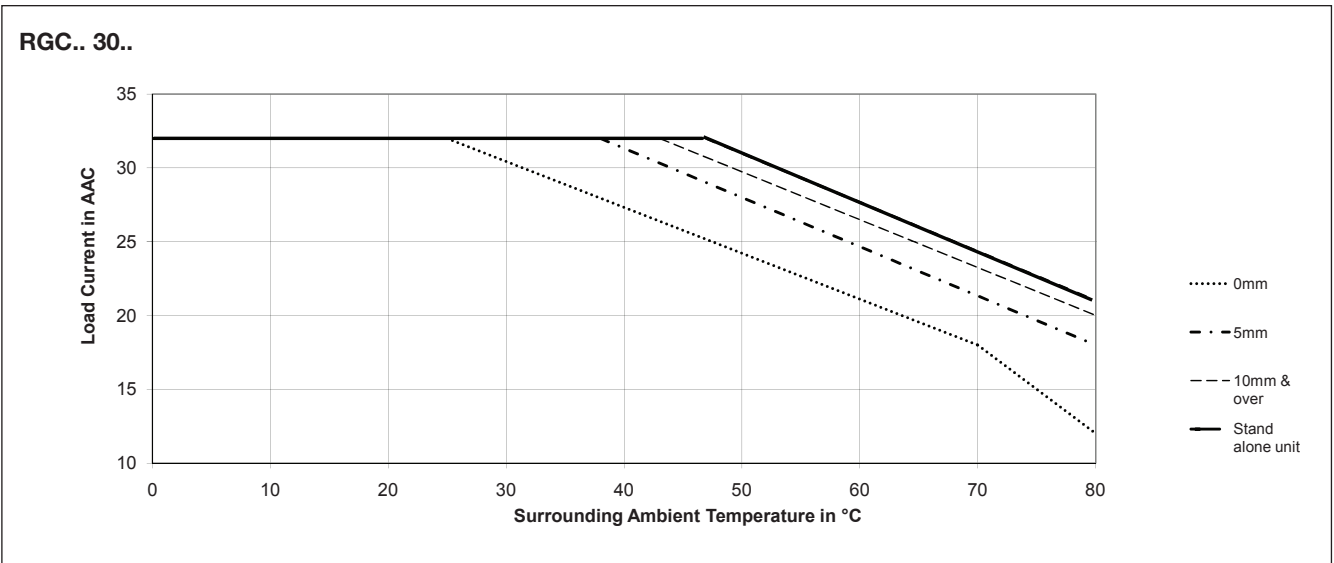

## Derating vs. Spacing Curves

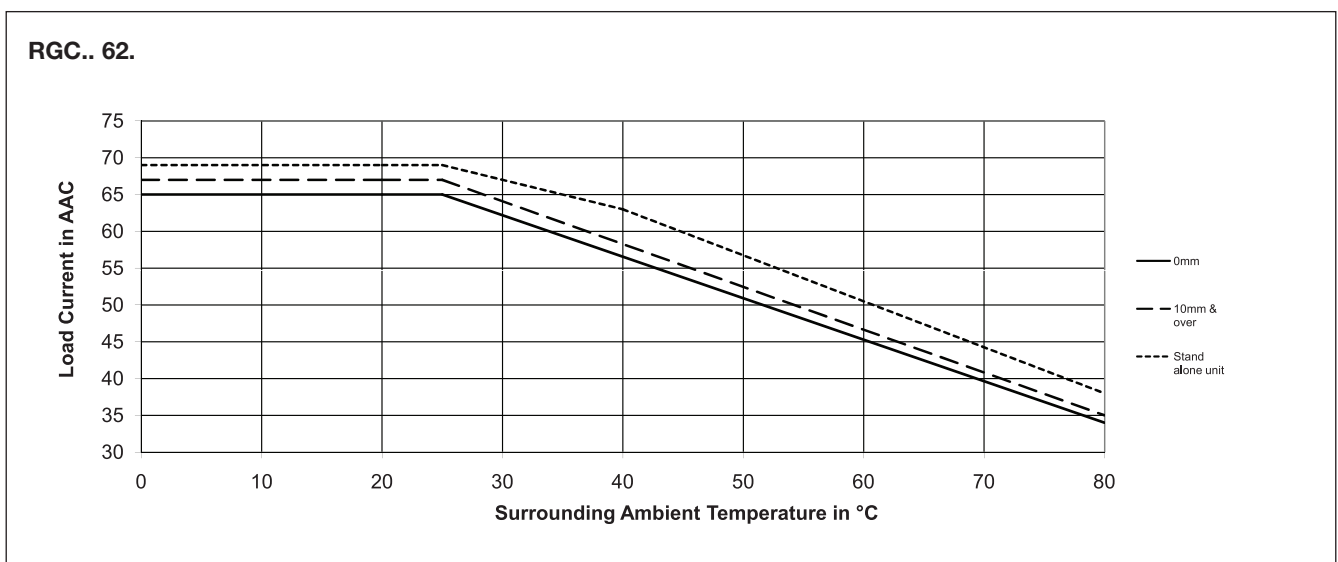
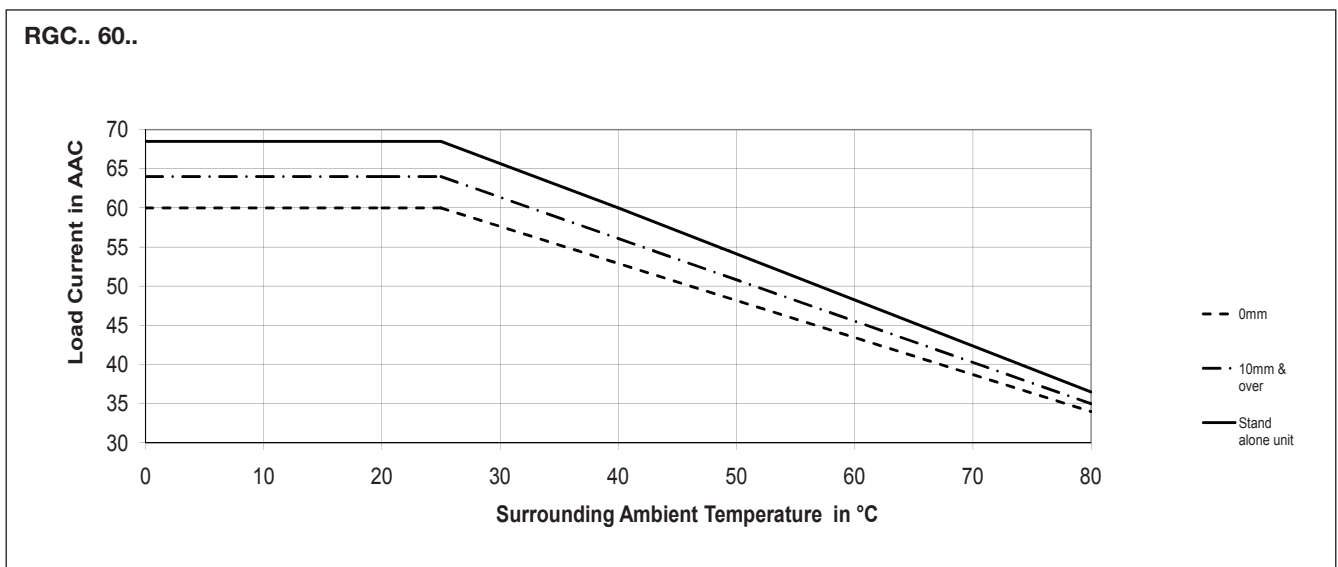
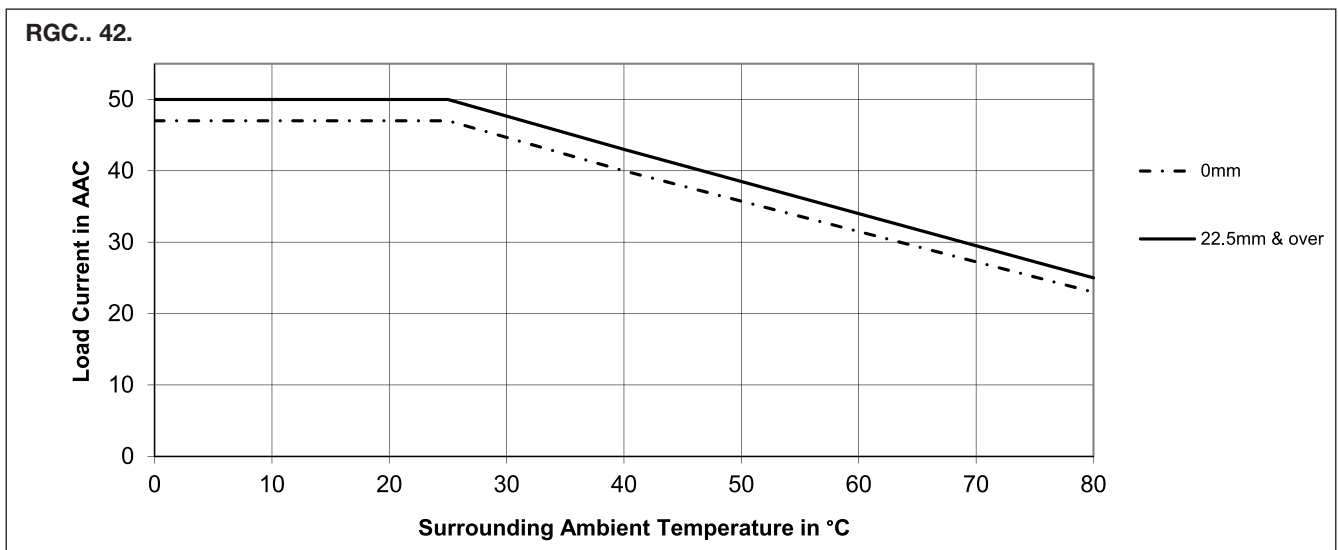

## Derating vs. Spacing Curves

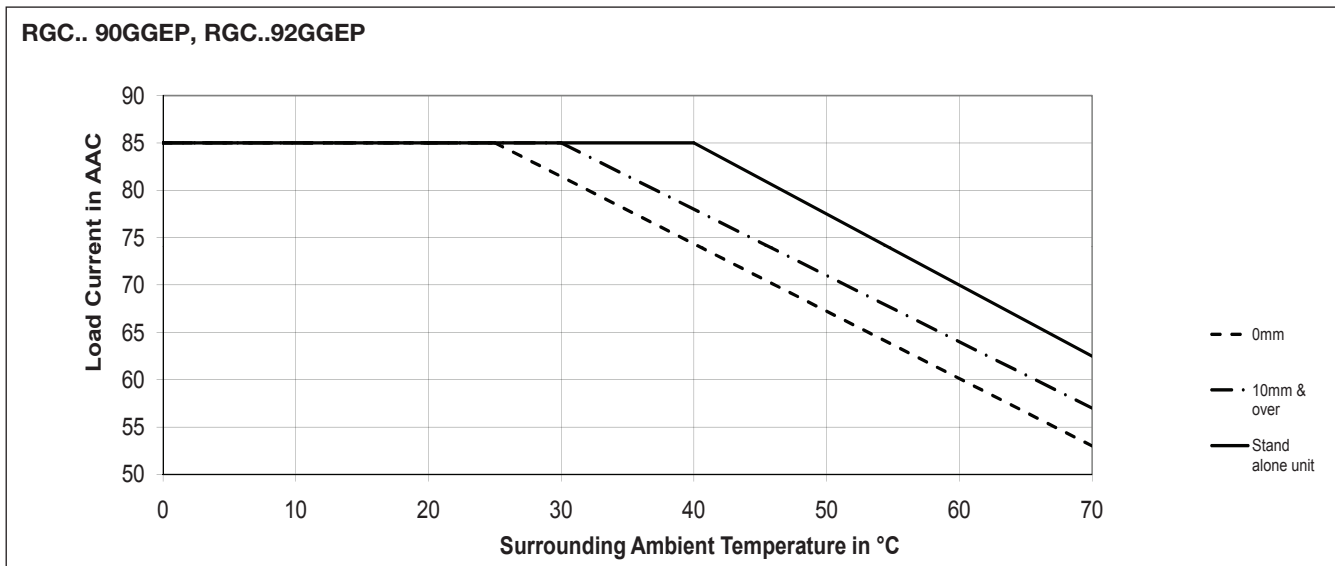

## Environmental Specifications

Operating temperature <sup>13</sup>	-40°C to 80°C (-40°F to +176°F)	Relative humidity	95% non-condensing @ 40°C
Storage temperature	-40°C to 100°C (-40°F to +212°F)	UL flammability rating (housing)	UL 94 V0 Glow wire ignition temperature and Glow wire flammability index conform to EN 60335-1 requirements
EU RoHS compliant	Yes	Installation altitude	0 - 1000m. Above 1000m derate linearly by 1% of FLC per 100m up to maximum of 2000m
China RoHS compliant	Refer to Environmental Information (page 29)		
Impact resistance (EN50155, EN61373)	15/11 g/ms		
Vibration resistance (2-100Hz, IEC60068-2-6, EN50155, EN61373)	2g per axis		
Weight			
RGC..15	approx. 260g	RGC..30 (P)	approx. 375g (412g)
RGC..20	approx. 315g	RGC..4x (P)	approx. 515g (581g)
RGC..25	approx. 260g	RGC..6x (P)	approx. 972g (1020g)
RGC..32	approx. 260g	RGC..9x P	approx. 1100g
RGC..32..GE	approx. 269g		

## Agency Approvals and Conformances

Conformance	IEC/EN 62314 IEC/EN 60947-4-2 IEC/EN 60947-4-3	Agency Approvals	UL508 Listed (E172877) cUL Listed (E172877) VDE 0660-109 <sup>15</sup> GL <sup>14</sup>
		Short Circuit Current Rating	100kA, UL508



13. Operating temperature range for RGC..P (overtemperature protection) is -30°C to 70°C (-22°F to 158°F)

14. Applicable to models RGC1...15.KE, RGC1...20.KE, RGC1...25..KE and RGC1...30.KE

15. RGC..32 models are not VDE approved

## Electromagnetic Compatibility

<b>EMC Immunity</b>	EN 60947-4-3	<b>Electrical Surge Immunity</b> (for RGC...EP)	IEC/EN 61000-4-5
<b>Electrostatic Discharge (ESD) Immunity</b> Air discharge, 8kV Contact, 4kV	IEC/EN 61000-4-2 Performance Criteria 1 Performance Criteria 1	Output, line to line, 1kV Output, line to earth, 2kV DC lines, line to line, 500V DC lines, line to earth, 500V Signal lines, line to earth, 1kV	Performance Criteria 1 Performance Criteria 1 Performance Criteria 2 Performance Criteria 2 Performance Criteria 2
<b>Electrical Fast Transient (Burst) Immunity</b> Output: 2kV, 5kHz Input: 1kV, 5kHz	IEC/EN 61000-4-4 Performance Criteria 1 Performance Criteria 1	<b>Radiated Radio Frequency Immunity</b> 10V/m, 80 - 1000 MHz 10V/m, 1.4 - 2 GHz 3V/m, 2 - 2.7 GHz	IEC/EN 61000-4-3 Performance Criteria 1 Performance Criteria 1 Performance Criteria 1
<b>Electrical Surge Immunity</b> (for RGC...E) Output, line to line, 1kV Output, line to earth, 2kV Input, line to line, 1kV Input, line to earth, 2kV	IEC/EN 61000-4-5 Performance Criteria 1 Performance Criteria 1 Performance Criteria 2 Performance Criteria 2	<b>Conducted Radio Frequency Immunity</b> 10V/m, 0.15 - 80 MHz	IEC/EN 61000-4-6 Performance Criteria 1
		<b>Voltage Dips Immunity</b> 0% for 0.5, 1 cycle 40% for 10 cycles 70% for 25 cycles 80% for 250 cycles	IEC/EN 61000-4-11 Performance Criteria 2 Performance Criteria 2 Performance Criteria 2 Performance Criteria 2
		<b>Voltage Interruptions Immunity</b> 0% for 5000ms	IEC/EN 61000-4-11 Performance Criteria 2
<b>EMC Emission</b>	EN 60947-4-3	<b>Radio Interference Field Emission (Radiated)</b> <b>30 - 1000MHz</b>	IEC/EN 55011 Class A (industrial)
<b>Radio Interference Voltage Emission (Conducted)</b> <b>0.15 - 30MHz</b>	IEC/EN 55011 Class A (industrial) with filters - see filter information		

### Note:

- Control input lines must be installed together to maintain products' susceptibility to Radio Frequency interference.
- Use of AC solid state relays may, according to the application and the load current, cause conducted radio interferences. Use of mains filters may be necessary for cases where the user must meet E.M.C requirements. The capacitor values given inside the filtering specification tables should be taken only as indications, the filter attenuation will depend on the final application.
- Performance Criteria 1: No degradation of performance or loss of function is allowed when the product is operated as intended.
- Performance Criteria 2: During the test, degradation of performance or partial loss of function is allowed. However when the test is complete the product should return operating as intended by itself.
- Performance Criteria 3: temporary loss of function is allowed, provided the function can be restored by manual operation of the controls.

## Filtering - EN / IEC 55011 Class A compliance (for class B compliance contact us)

Part Number	Suggested filter for compliance	Maximum Heater current
RGC1A23..15	68nF / 275 V / X1	20A
RGC1A23..20	68nF / 275 V / X1	20A
RGC1A23..25, RGC1A23..30	220 nF / 275V / X1	30A
RGC1A23..40	220 nF / 275V / X1 330 nF / 275V / X1	30A 45A
RGC1A23..60	220 nF / 275V / X1 330 nF / 275V / X1	30A 45A
RGC1A23..42, RGC1A23..62	330 nF / 275V / X1 680 nF / 275V / X1	35A 65A
RGC1A60..15	100 nF / 760V / X1	20A
RGC1A60..20	100 nF / 760V / X1	20A
RGC1A60..25, RGC1A60..30	220 nF / 760V / X1	30A
RGC1A60..40	220 nF / 760V / X1 330 nF / 760V / X1	25A 45A
RGC1A60..60	220 nF / 760V / X1 330 nF / 760V / X1	25A 45A
RGC1A60..32, RGC1A60..42, RGC1A60..62, RGC1A60..9x	330 nF / 760V / X1 680 nF / 760V / X1	40A 65A

## Filter Connection Diagrams

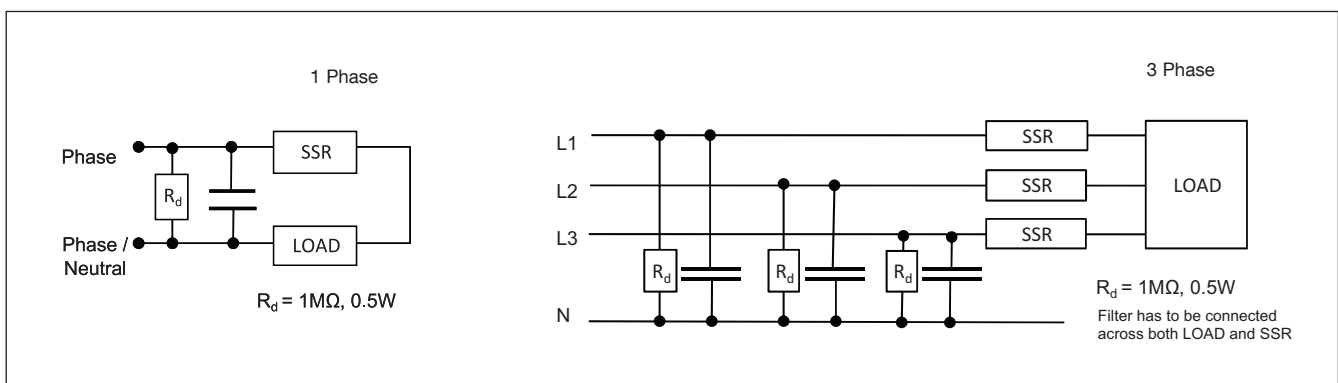

## Additional Conformance to Railway standards

Applicable to variants	RGC..	Additional EMC conformance	according to EN 50121-3-2
Additional conformance specific to Railway applications	EN 50155 EN 45545-2 EN 50121-3-2	Radiated radio frequency Immunity 20V/m, 80 MHz - 1 GHz 10V/m, 1.4 - 2 GHz 5V/m, 2 - 2.7 GHz 3V/m, 5.1 - 6 GHz	IEC/EN 61000-4-3 Performance Criteria 1 Performance Criteria 1 Performance Criteria 1 Performance Criteria 1
Hazardous level conformance according to EN 45545-2	HL1, HL2 for requirement R23 HL1 for requirement R22	Power Quality Measurement 50 Hz - 2 kHz, <8% THD	IEC/EN 61000-4-30 Pass
Operating temperature class according to EN 50155	OT3 (-25 °C to +70 °C)		
Vibration and shock	EN 61373 Category 1, Class B		

## Functional Diagram (Without OTP)

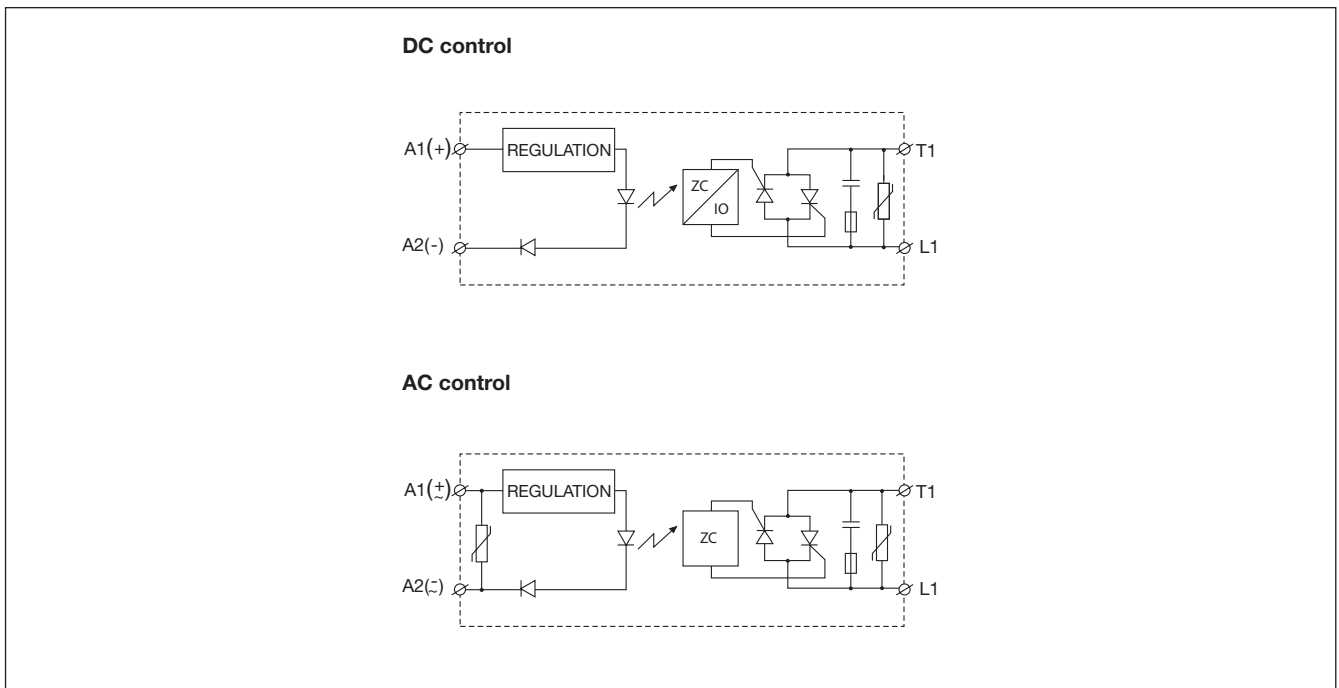

## Connection Diagram (Without OTP)

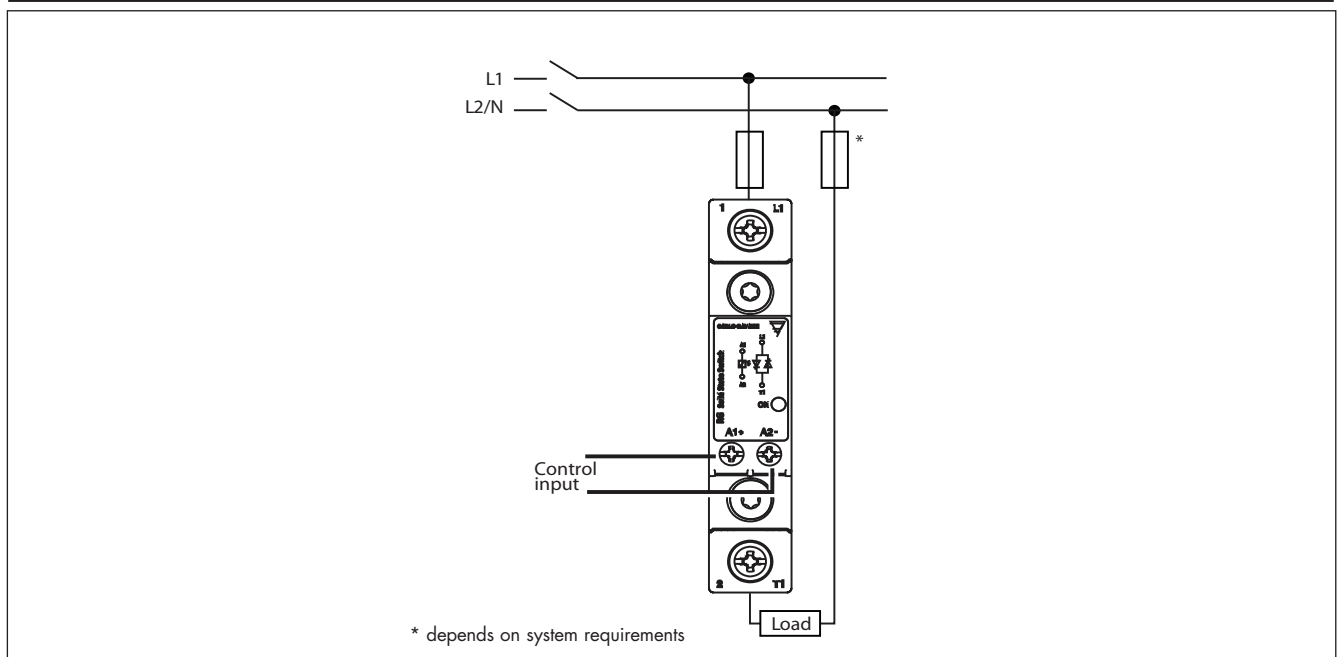



## Connection Diagram (with OTP)

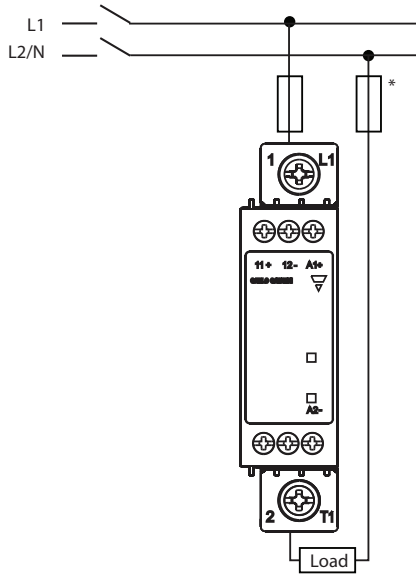

\* depends on system requirements

### DC Control

RGC1...D30GKEP, RGC1...D4xGGEP,  
RGC1...D6xGGEP

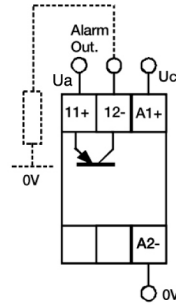

Uc: 5 - 32 VDC  
Ua: max 35VDC  
Alarm Output: max. 50mA

A1, A2: Control voltage  
11, 12: Alarm output

RGC1...D9xGGEP

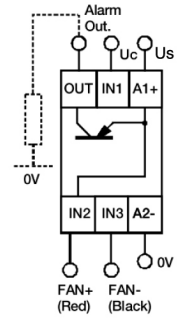

Uc: 5 - 32 VDC  
Us: 24 VDC  
Alarm Output: max. 50mA

Note: Fan is internally supplied

A1, A2: Supply voltage  
IN1: Control voltage  
OUT: Alarm output

### AC Control

RGC1...A30GKEP, RGC1...A4xGGEP,  
RGC1...A6xGGEP

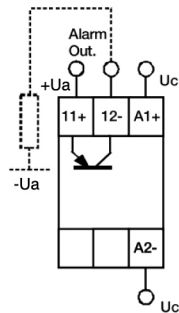

Uc: 24 - 275 VAC  
24 - 190 VDC  
Ua: max 35VDC  
Alarm Output: max. 50mA

A1, A2: Control voltage  
11, 12: Alarm output

RGC1...A9xGGEP

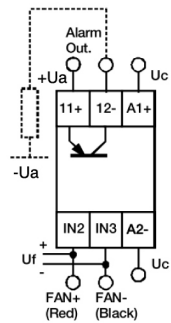

Uc: 24 - 275 VAC  
24 - 190 VDC  
Ua: max. 35 VDC  
Alarm Output: max. 50mA  
Uf: 24 VDC (needs to be supplied externally)

A1, A2: Control voltage  
11, 12: Alarm output  
IN2, IN3: Fan supply

## Terminal Layout and Dimensions

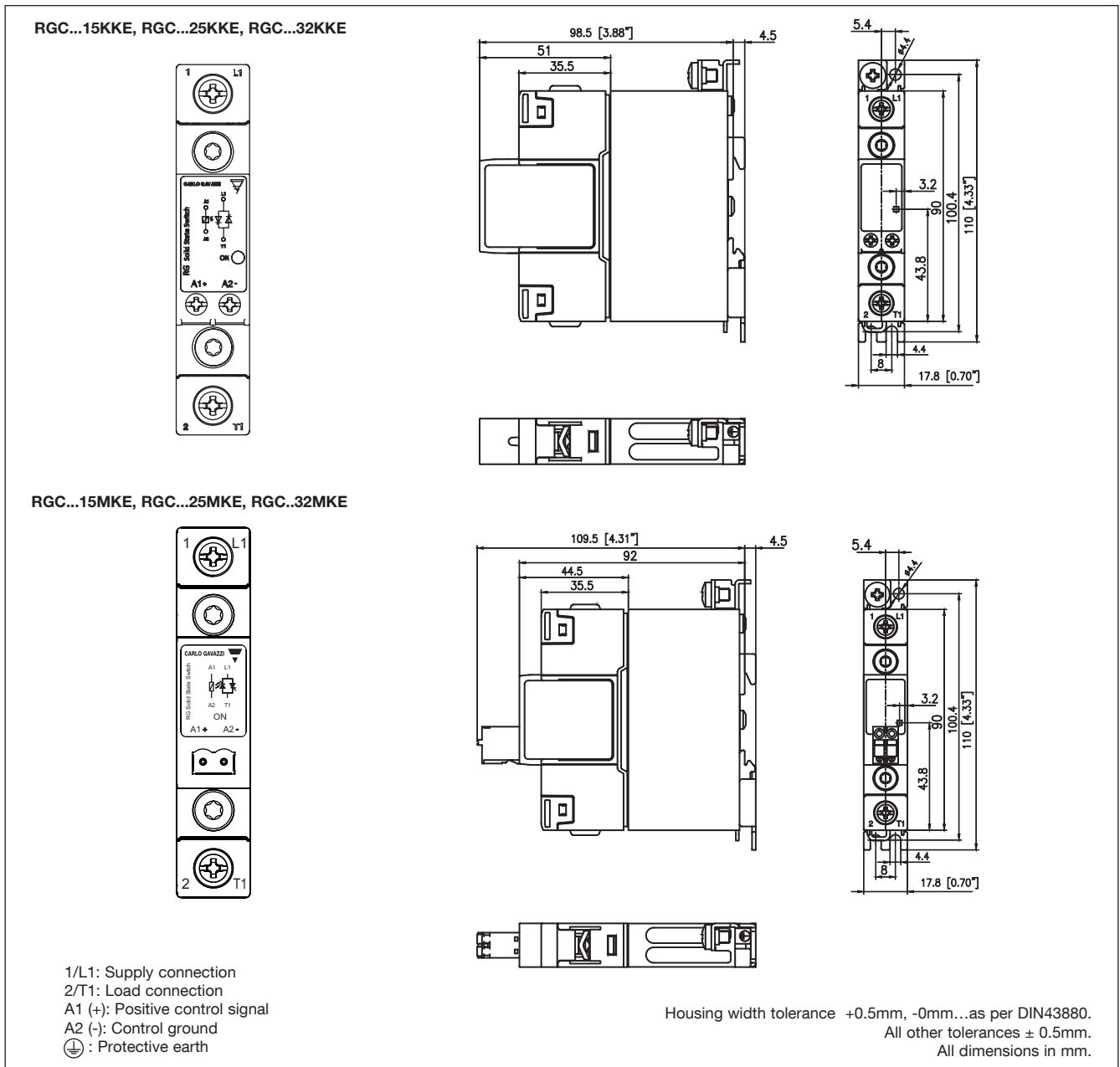

## Terminal Layout and Dimensions (cont).

RGC..32KGE

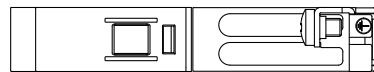
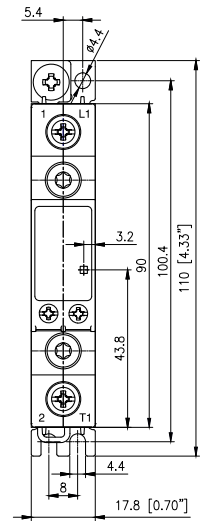
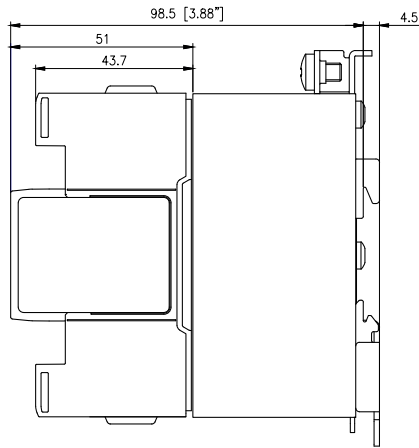
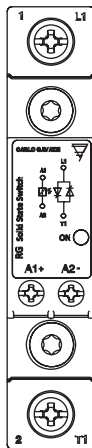

RGC..32MGE

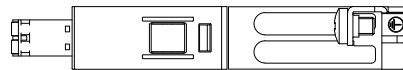
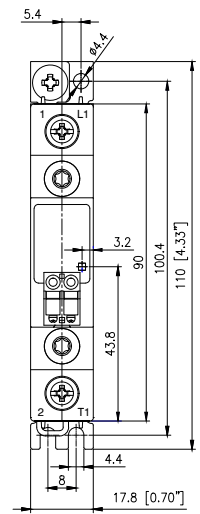
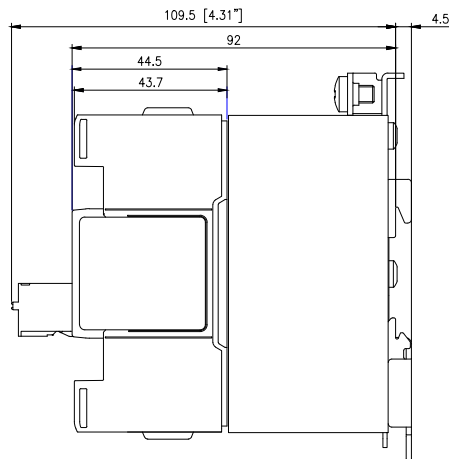
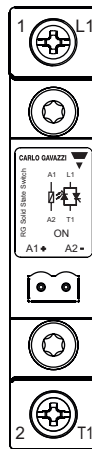

- 1/L1: Supply connection
- 2/T1: Load connection
- A1 (+): Positive control signal
- A2 (-): Control ground
- ⊕: Protective earth

Housing width tolerance +0.5mm, -0mm...as per DIN43880.  
 All other tolerances ± 0.5mm.  
 All dimensions in mm.

## Terminal Layout and Dimensions (cont).

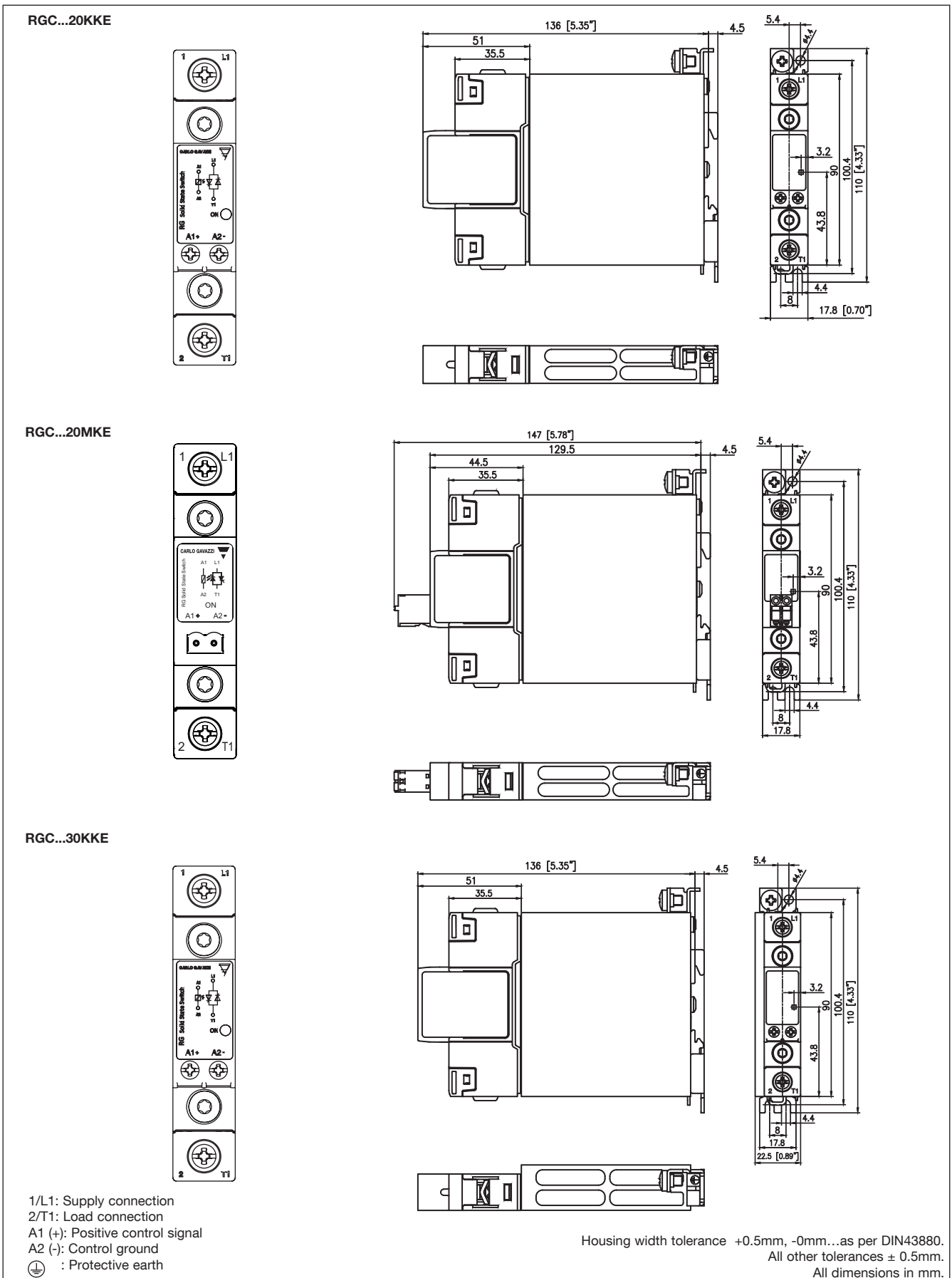

## Terminal Layout and Dimensions (cont.)

RGC...30MKE

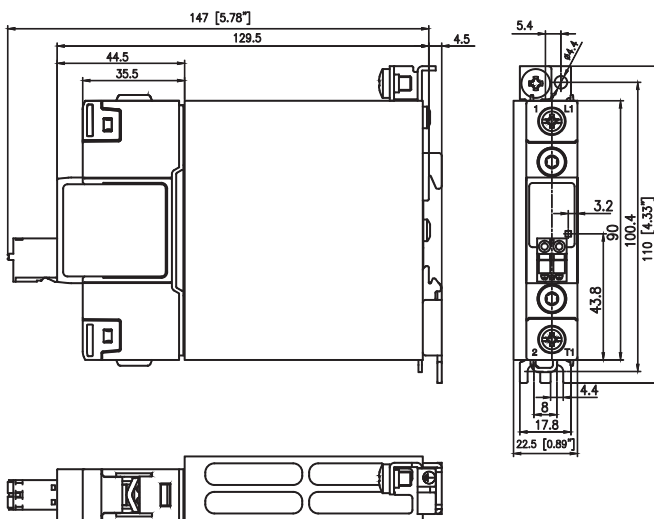
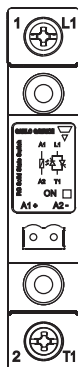

RGC...40KGE, RGC...42KGE

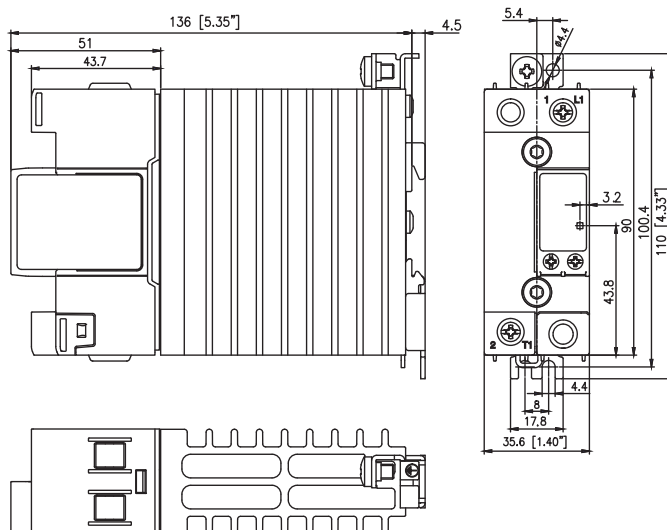
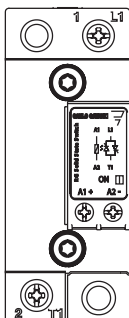

RGC...40MGE, RGC...42MGE

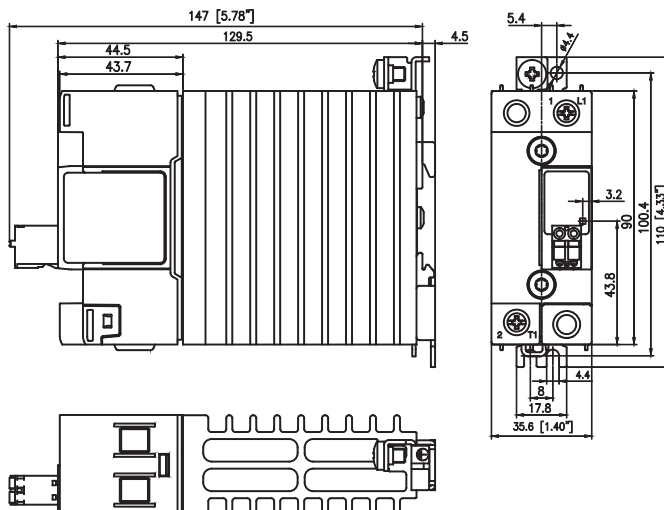
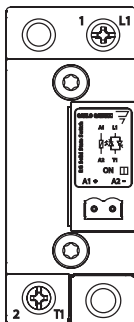

- 1/L1: Supply connection
- 2/T1: Load connection
- A1 (+): Positive control signal
- A2 (-): Control ground
- ⊕ : Protective earth

Housing width tolerance +0.5mm, -0mm...as per DIN43880.  
All other tolerances ± 0.5mm. All dimensions in mm.

## Terminal Layout and Dimensions (cont.)

RGC...60KGE, RGC...62KGE

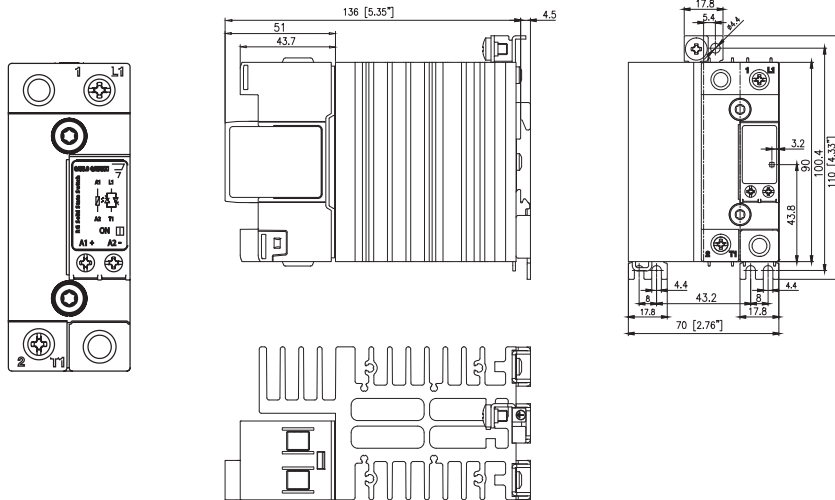

RGC...62MGE

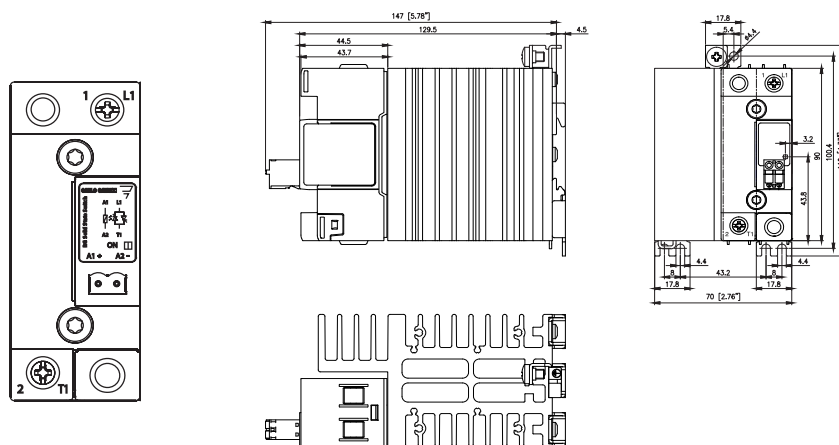

- 1/L1: Supply connection
- 2/T1: Load connection
- A1 (+): Positive control signal
- A2 (-): Control ground
- ⊕ : Protective earth

Housing width tolerance +0.5mm, -0mm...as per DIN43880.  
 All other tolerances ± 0.5mm.  
 All dimensions in mm.

## Terminal Layout and Dimensions (cont.)

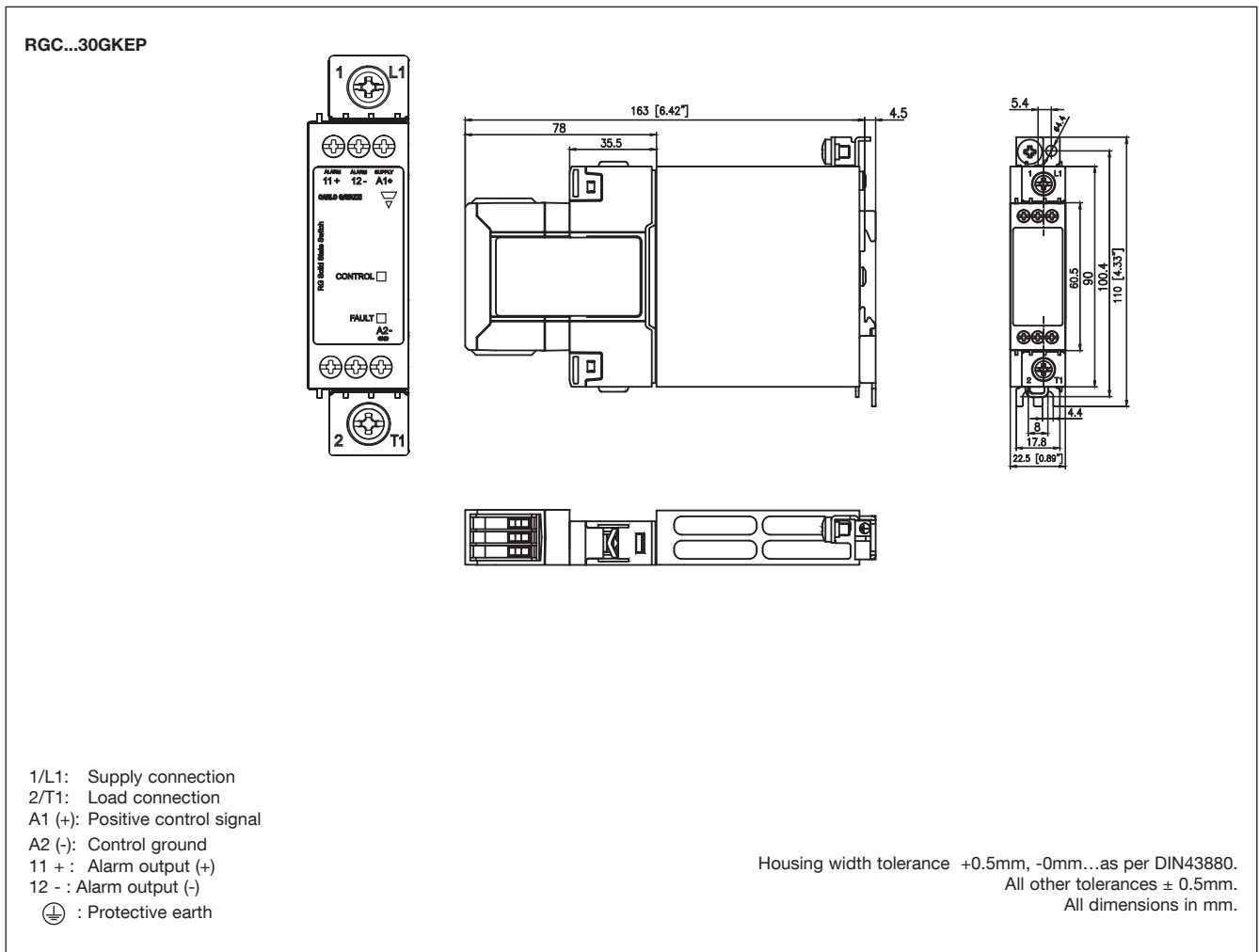

## Terminal Layout and Dimensions (cont.)

### RGC...40GGEP, RGC...42GGEP

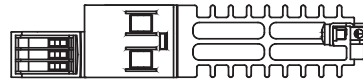
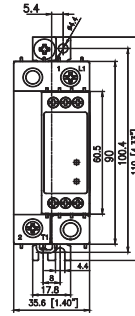
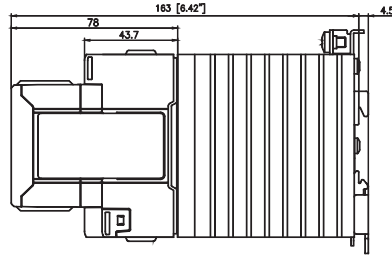
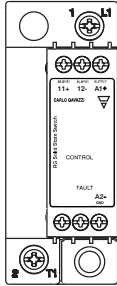

### RGC...60GGEP, RGC...62GGEP

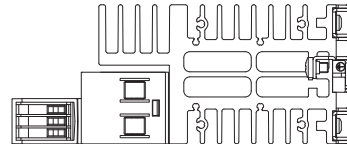
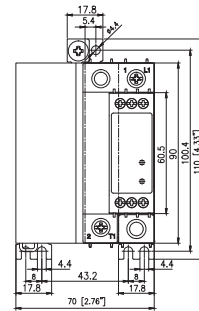
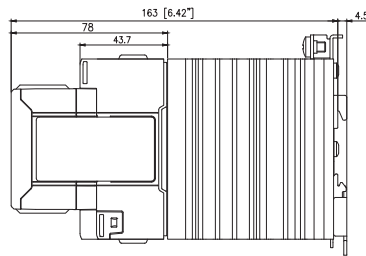
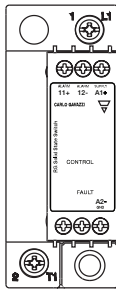

### RGC...90GGEP, RGC...92GGEP

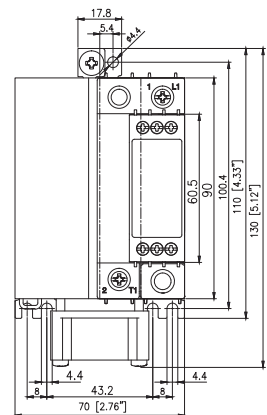
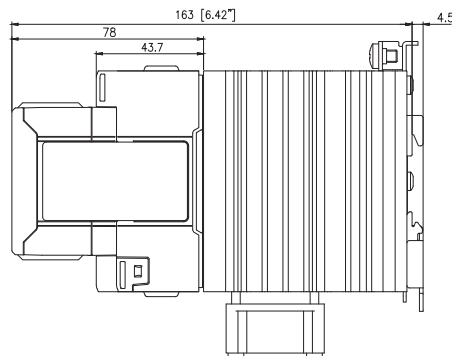
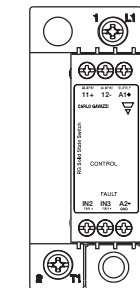
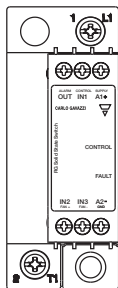

RGC...D9xGGEP

RGC...A9xGGEP

- 1/L1: Supply connection
- 2/T1: Load connection
- A1 (+): Positive control signal  
(Positive supply in case of RGC1A60D9xGGEP)
- A2 (-): Control ground
- IN1: Control signal (only for RGC1A60D9xGGEP)
- IN2: Fan + supply (only for RGC1A60A9xGGEP)
- IN3: Fan - supply (only for RGC1A60A9xGGEP)
- 11 + : Alarm output (+)
- OUT, 12 - : Alarm output (-)
- : Protective earth

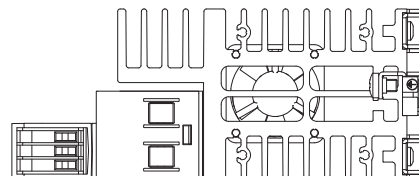









Housing width tolerance +0.5mm, -0mm...as per DIN43880.  
All other tolerances ± 0.5mm. All dimensions in mm.

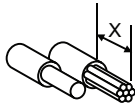

## Connection Specifications

### POWER CONNECTIONS: 1/L1, 2 /T1

Use 75°C copper (Cu) conductors

	RG...KKE ; RG..GKEP. ; RG...MKE		RG...KGE ; RG...GGEP ; RG...MGE	
<b>Stripping Length (X)</b>	12mm		11mm	
<b>Connection type</b>	M4 screw with captivated washer		M5 screw with box clamp	
<b>Rigid (Solid &amp; Stranded)</b> UL / cUL rated data		 2 x 2.5..6 mm <sup>2</sup> 2 x 14.. 10 AWG	 1 x 2.5..6 mm <sup>2</sup> 1 x 14.. 10 AWG	 1 x 2.5..25mm <sup>2</sup>  1 x 14..3 AWG
<b>Flexible with end sleeve</b>		2 x 1.0 ... 2.5mm <sup>2</sup> 2 x 2.5..4mm <sup>2</sup> 2 x 18.. 14 AWG 2 x 14.. 12 AWG	1 x 1.0..4mm <sup>2</sup> 1 x 18.. 12 AWG	1 x 2.5..16mm <sup>2</sup> 1 x 14.. 6 AWG
<b>Flexible without end sleeve</b>		2 x 1.0 ... 2.5mm <sup>2</sup> 2 x 2.5.. 6mm <sup>2</sup> 2 x 18.. 14 AWG 2 x 14.. 10 AWG	1 x 1.0.. 6mm <sup>2</sup> 1 x 18.. 10 AWG	1 x 4.. 25mm <sup>2</sup> 1 x 12.. 3 AWG
<b>Torque specifications</b>		Pozidriv 2 UL: 2Nm (17.7lb-in) IEC: 1.5 - 2.0Nm (13.3 - 17.7lb-in)	Posidriv 2 UL: 2.5Nm (22lb-in) IEC: 2.5 - 3.0Nm (22-26.6lb-in)	
<b>Aperture for termination lug</b>		12.3mm	N/A	

### Protective Earth (PE) Connection







M5, 1.5Nm (13.3 lb-in)

Note: M5 PE screw not provided with SSR. PE connection required when product is intended to be used in Class 1 applications according to EN/IEC 61140.

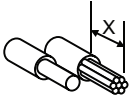

### CONTROL CONNECTIONS: A1(+), A2(-)

Use 60/75°C copper (Cu) conductors

	RG...KKE, RG..KGE		RG...MKE, RG...MGE	
<b>Torque specifications</b>		M3, Pozidriv 1 UL: 0.5Nm (4.4lb-in) IEC: 0.5 - 0.6Nm (4.4 - 5.3lb-in)		
<b>Stripping Length (X)</b>		8mm	12 - 13mm	
<b>Rigid (Solid &amp; Stranded)</b> UL/ cUL rated data		 2 x 0.5..2.5mm <sup>2</sup> 2 x 18..12 AWG	 1 x 0.5..2.5mm <sup>2</sup> 1 x 18..12 AWG	 1 x 0.2..2.5mm <sup>2</sup> 1 x 24...12 AWG
<b>Flexible with end sleeve</b>		2 x 0.5..2.5mm <sup>2</sup> 2 x 18..12AWG	1 x 0.5..2.5mm <sup>2</sup> 1 x 18..12AWG	

### CONTROL CONNECTIONS: A1(+), A2(-), IN1, IN2, IN3, 11 (+), 12(-), OUT

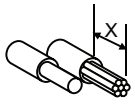
Use 60/75°C copper (Cu) conductors

	RG...GGEP	
<b>Torque specifications</b>		M3, Pozidriv 1 UL: 0.5Nm (4.4lb-in) IEC: 0.4 - 0.5Nm (3.5 - 4.4lb-in)
<b>Stripping Length (X)</b>		6mm
<b>Rigid (Solid &amp; Stranded)</b> UL/ cUL rated data		 2 x 1.0..2.5mm <sup>2</sup> 2 x 18..14 AWG
<b>Flexible with end sleeve</b>		2 x 1.0..2.5mm <sup>2</sup> 2 x 18..14 AWG

## Installation Instructions

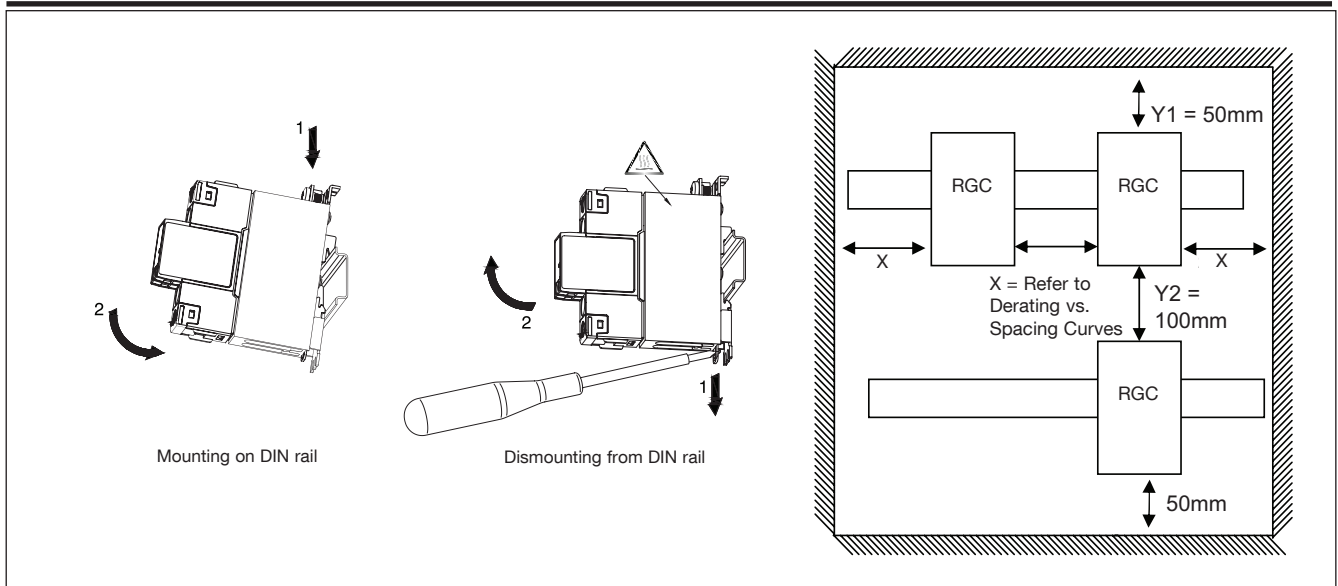

## Short Circuit Protection

### Protection Co-ordination, Type 1 vs Type 2:

Type 1 protection implies that after a short circuit, the device under test will no longer be in a functioning state. In type 2 co-ordination the device under test will still be functional after the short circuit. In both cases, however the short circuit has to be interrupted. The fuse between enclosure and supply shall not open. The door or cover of the enclosure shall not be blown open. There shall be no damage to conductors or terminals and the conductors shall not separate from terminals. There shall be no breakage or cracking of insulating bases to the extent that the integrity of the mounting of live parts is impaired. Discharge of parts or any risk of fire shall not occur.

The product variants listed in the table hereunder are suitable for use on a circuit capable of delivering not more than 100,000A rms Symmetrical Amperes, 600 Volts maximum when protected by fuses. Tests at 100,000A were performed with Class J fuses, fast acting; please refer to the table below for maximum allowed ampere rating of the fuse. Use fuses only.

Tests with Class J fuses are representative of Class CC fuses.

### Co-ordination type 1 (UL508)

Part No.	Prospective short circuit current [kArms]	Max. fuse size [A]	Class	Voltage [VAC]
RGC..15	100	30	J or CC	max. 600
RGC..20	100	30	J or CC	max. 600
RGC..25	100	30	J or CC	max. 600
RGC..30	100	30	J or CC	max. 600
RGC..32	100	80	J	max. 600
RGC..40	100	40	J	max. 600
RGC..42	100	90	J	max. 600
RGC..60	100	40	J	max. 600
RGC..62	100	90	J	max. 600
RGC..90	100	40	J	max. 600
RGC..92	100	90	J	max. 600

## Co-ordination type 2 (IEC/EN 60947-4-2/ -4-3)

Part No.	Prospective short circuit current [kArms]	Mersen (Ferraz Shawmut)		Siba		Voltage [VAC]
		Max fuse size [A]	Part number	Max fuse size [A]	Part number	
RGC..15	10	25	6.9xx CP GRC 14x51 /25	32	50 142 06.32	max. 600
	100	25	6.9xx CP GRC 14x51 /25	32	50 142 06.32	max. 600
RGC..20	10	40	6.6xx CP URD 22x58 /40	32	50 142 06.32	max. 600
	100	40	6.6xx CP URD 22x58 /40	32	50 142 06.32	max. 600
RGC..25	10	40	6.9xx CP GRC 22x58 /40	32	50 142 06.32	max. 600
	100	40	6.6xx CP URD 22x58 /40	32	50 142 06.32	max. 600
RGC..30	10	40	6.9xx CP GRC 22x58 /40	32	50 142 06.32	max. 600
	100	40	6.6xx CP URD 22x58 /40	32	50 142 06.32	max. 600
RGC..40	10	63	6.621 CP URGD 27x60 /63	63	50 194 20.63	max. 600
	10	70	A70QS70-4	63	50 194 20.63	max. 600
	100	63	6.621 CP URQ 27x60 /63	63	50 194 20.63	max. 600
RGC..32	10	63	6.9xx CP URC 14x51 /63	80	50 194 20.80	max. 600
RGC..42	10	70	A70QS70-4	80	50 194 20.80	max. 600
	100	63	6.9xx CP URC 14x51 /63	80	50 194 20.80	max. 600
	100	70	A70QS70-4	80	50 194 20.80	max. 600
RGC..60 up to 65AAC	10	80	6.621 CP URQ 27x60 /80	80	50 194 20.80	max. 600
	100	n/a	n/a	80	50 194 20.80	max. 600
RGC..62	10	100	6.9xx CP GRC 22x58 /100	100	50 194 20.100	max. 600
	10	100	A70QS100-4	100	50 194 20.100	max. 600
	100	100	6.621 CP URGD 27x60 /100	100	50 194 20.100	max. 600
	100	100	A70QS100-4	100	50 194 20.100	max. 600
RGC..90 up to 80AAC	10	100	6.621 CP URQ 27x60 /100	100	50 194 20.100	max. 600
	10	100	A70QS100-4	100	50 194 20.100	max. 600
	100	n/a	n/a	100	50 194 20.100	max. 600
RGC..92	10	125	6.621 CP URQ 27x60 /125	125	50 194 20.125	max. 600
	10	125	A70QS125-4	125	50 194 20.125	max. 600
	100	125	6.621 CP URQ 27x60 /125	125	50 194 20.125	max. 600
	100	125	A70QS125-4	125	50 194 20.125	max. 600

## Type 2 Protection with Miniature Circuit Breakers (M.C.B.s)

Solid State Relay type	ABB Model no. for Z - type M. C. B. (rated current)	ABB Model no. for B - type M. C. B. (rated current)	Wire cross sectional area [mm <sup>2</sup> ]	Minimum length of Cu wire conductor [m] <sup>16</sup>
<b>RGC..15</b> <b>RGC..20</b> (525 A <sup>2</sup> s)	<b>1 pole</b> S201 - Z4 (4A) S201 - Z6 UC (6A)	S201 - B2 (2A) S201 - B2 (2A)	1.0	21.0
			1.0	21.0
			1.5	31.5
<b>RGC..25</b> <b>RGC..30</b> (1800 A <sup>2</sup> s)	<b>1 pole</b> S201 - Z10 (10A)	S201-B4 (4A)	1.0	7.6
			1.5	11.4
			2.5	19.0
	S201 - Z16 (16A)	S201-B6 (6A)	1.0	5.2
			1.5	7.8
			2.5	13.0
	S201 - Z20 (20A)	S201-B10 (10A)	1.5	12.6
			2.5	21.0
			4.0	
	S201 - Z25 (25A)	S201-B13 (13A)	2.5	25.0
			4.0	40.0
	<b>2 pole</b> S202 - Z25 (25A)	S202-B13 (13A)	2.5	19.0
			4.0	30.4
	<b>RGC..40</b> (3200 A <sup>2</sup> s)	<b>1 pole</b> S201 - Z25 (25A)	S201-B13 (13A)	2.5
4.0				11.2
6.0				16.8
<b>RGC..60</b> (3200 A <sup>2</sup> s)	<b>1 pole</b> S201 - Z25 (25A)	S201-B13 (13A)	2.5	7.0
			4.0	11.2
			6.0	16.8
<b>RGC..90</b> (6600 A <sup>2</sup> s)	<b>1 pole</b> S201 - Z20 (20A)	S201-B10 (10A)	1.5	4.2
			2.5	7.0
			4.0	11.2
	S201 - Z32 (32A)	S201-B16 (16A)	2.5	13.0
			4.0	20.8
			6.0	31.2
	<b>2 pole</b> S202 - Z20 (20A)	S202-B10 (10A)	1.5	1.8
			2.5	3.0
			4.0	4.8
	S202 - Z32 (32A)	S202-B16 (16A)	2.5	5.0
			4.0	8.0
			6.0	12.0
	S202 - Z50 (50A)	S202-B25 (25A)	10.0	20.0
			4.0	14.8
			6.0	22.2
		10.0	37.0	
<b>RGC..32</b> <b>RGC..42</b> <b>RGC..62</b> <b>RGC..92</b> (18000 A <sup>2</sup> s)	<b>1 pole</b> S201-Z32 (32A)	S201-B16 (16A)	2.5	3.0
			4.0	4.8
			6.0	7.2
	S201-Z50 (50A)	S201-B25 (25A)	4.0	4.8
			6.0	7.2
			10.0	12.0
			16.0	19.2
	S201-Z63 (63A)	S201-B32 (32A)	6.0	7.2
			10.0	12.0
			16.0	19.2

16. Between MCB and Load (including return path which goes back to the mains).

Note: A prospective current of 6kA and a 230/400V power supply system is assumed for the above suggested specifications. For cables with different cross section than those mentioned above please consult Carlo Gavazzi's Technical Support Group.

## Environmental Information

The declaration in this section is prepared in compliance with People's Republic of China Electronic Industry Standard SJ/T11364-2014: Marking for the Restricted Use of Hazardous Substances in Electronic and Electrical Products.

Part Name	Toxic or Harardous Substances and Elements					
	Lead (Pb)	Mercury (Hg)	Cadmium (Cd)	Hexavalent Chromium (Cr(VI))	Polybrominated biphenyls (PBB)	Polybrominated diphenyl ethers (PBDE)
Power Unit Assembly	x	○	○	○	○	○
<p>○: Indicates that said hazardous substance contained in homogeneous materials for this part are below the limit requirement of GB/T 26572.</p> <p>X: Indicates that said hazardous substance contained in one of the homogeneous materials used for this part is above the limit requirement of GB/T 26572.</p>						

## 环境特性

这份申明根据中华人民共和国电子工业标准 SJ/T11364-2014：标注在电子电气产品中限定使用的有害物质

零件名称	有毒或有害物质与元素					
	铅 (Pb)	汞 (Hg)	镉 (Cd)	六价铬 (Cr(VI))	多溴化联苯 (PBB)	多溴联苯醚 (PBDE)
功率单元	x	○	○	○	○	○
<p>○:此零件所有材料中含有的该有害物低于GB/T 26572的限定。</p> <p>X: 此零件某种材料中含有的该有害物高于GB/T 26572的限定。</p>						



## Accessories

---

### Control Plugs



#### Ordering Key

Pack of 10 spring loaded control plugs

**RGM25**

\* Refer to 'Connection Specifications' section for further details.

### Packaging



#### Ordering Key

Bulk packaging of 20 pcs.

**RGC...X20**

Applicable only to RGC..15, RGC..25 and RGC..32 models

# Mouser Electronics

Authorized Distributor

Click to View Pricing, Inventory, Delivery & Lifecycle Information:

## Carlo Gavazzi:

[RGC1A60D15KKE](#) [RGC1A60A20GKEP](#) [RGC1A23D25KKE](#) [RGC1A60D42MGE](#) [RGC1A60D25MKE](#)  
[RGC1A60D40MGE](#) [RGC1A60D25GKEP](#) [RGC1A23D20GKEP](#) [RGC1A23A30KKE](#) [RGC1A23A30MKE](#)  
[RGC1A60D62KGE](#) [RGC1A60D60KGE](#) [RGC1A60D62GGEP](#) [RGC1A23D42MGE](#) [RGC1A60A25KKE](#)  
[RGC1A60A62GGEP](#) [RGC1B60D30KKE](#) [RGC1A60A20MKE](#) [RGC1A60A60GGEP](#) [RGC1A60D32KGE](#)  
[RGC1A23A40KGE](#) [RGC1A60A20KKE](#) [RGC1A23A20KKE](#) [RGC1B60D62KGE](#) [RGC1A60A40GGEP](#)  
[RGC1B60D15KKE](#) [RGC1A60D40GGUP](#) [RGC1A60D42GGEP](#) [RGC1A23D30MKE](#) [RGC1B60D60KGE](#)  
[RGC1A60D32MGE](#) [RGC1A60D20MKE](#) [RGC1A60D25KKE](#) [RGC1A23A42KGE](#) [RGC1A23A20MKE](#)  
[RGC1A23D42KGE](#) [RGC1A23D60KGE](#) [RGC1A60D15MKE](#) [RGC1A23D15MKE](#) [RGC1A60D90GGEP](#)  
[RGC1A60A30KKE](#) [RGC1A23A42MGE](#) [RGC1A23D20KKE](#) [RGC1A60D32KKE](#) [RGC1A60D30MKE](#)  
[RGC1A23A62KGE](#) [RGC1A23D30GKEP](#) [RGC1A60D20KKE](#) [RGC1A23D30KKE](#) [RGC1A23A25MKE](#)  
[RGC1A60A15MKE](#) [RGC1A23D15KKE](#) [RGC1A60A40KGE](#) [RGC1A23A60KGE](#) [RGC1B60D20KKE](#)  
[RGC1A60A62MGE](#) [RGC1A60D40GGEP](#) [RGC1A60A42GGEP](#) [RGC1A23A62MGE](#) [RGC1A23D62MGE](#)  
[RGC1A23A15MKE](#) [RGC1A60A92GGEP](#) [RGC1A60D40KGE](#) [RGC1A60A25MKE](#) [RGC1A60A25GKEP](#)  
[RGC1A23D62KGE](#) [RGC1A60A40MGE](#) [RGC1A60D92GGEP](#) [RGC1A60A15KKE](#) [RGC1A23D20MKE](#)  
[RGC1A23D90GGEP](#) [RGC1A23D25MKE](#) [RGC1A60A42MGE](#) [RGC1A60D30GKEP](#) [RGC1A60A60KGE](#)  
[RGC1A23D40KGE](#) [RGC1A60A90GGEP](#) [RGC1A60D42KGE](#) [RGC1A60D60GGEP](#) [RGC1A60D30KKE](#)  
[RGC1A60A62KGE](#) [RGC1B60D25KKE](#) [RGC1B60D40KGE](#) [RGC1A60D62MGE](#) [RGC1A60A42KGE](#)  
[RGC1A23A15KKE](#) [RGC1A60D32MKE](#) [RGC1A23A25KKE](#)