



Sensing Distance			Amplifiers
			E3S-X3, E3X, E3XA, E3A2-X, E3XR, E3C-X

## Fiber-optic Cables

E32

Extensive Selection of Fiber-optic Sensing Heads Offers Many Unique Solutions for Tough Problems

- Fiber-optic sensors detect small, fast-moving objects in space-confined installations and harsh environments
- For a custom fit in the field, most plastic filament cables can be cut to length
- For detection in hard-to-reach places, sensing heads with bendable stainless steel tubing retain complex shapes
- Coiled and ultra-flexible cables are ideal for flexing and reciprocating machinery such as robots
- *Periscope* sensing heads or accessories save space in right angle detection
- Convergent beam sensing heads allow accurate positioning, even for shiny objects
- Narrow detection zone of concentric beam sensing heads helps eliminate background objects and gives consistent sensing, regardless of object direction
- Most fiber cables offer IP67 protection and temperature ratings of -40°C to 70°C (-40°F to 158°F)





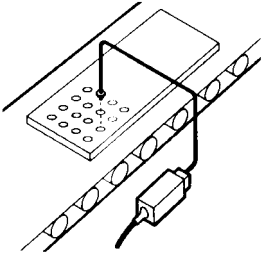
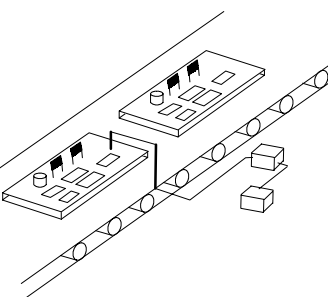
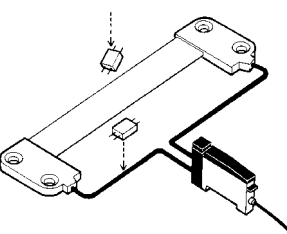
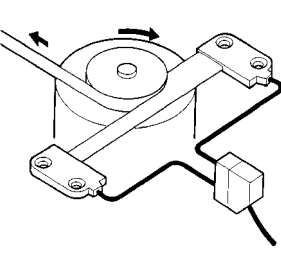

## Application Examples

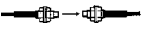
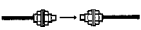

Detect small holes in machine parts	Detecting presence of printed circuit board components	Detects metal or non-metal chips within a sensing area as large as 2 x 11-mm	Detects when tape roll has reached selected diameter
		 <p data-bbox="834 596 1084 617">Chips need not be in a straight line.</p> <p data-bbox="834 638 1073 674">Sensor, used vertically, will detect object as tiny as 1.3 mm.</p>	 <p data-bbox="1170 632 1398 667">Outputs a signal when selected diameter is reached.</p>

## Ordering Information

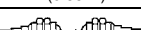
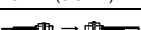
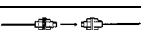
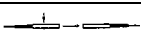
### ■ THROUGH-BEAM TYPE

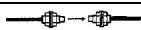
#### General Purpose

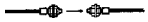
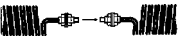
Part Number	Appearance	Cable Length	Sensing Distance	Minimum Object Size	Fiber Material		Remarks
					Core	Sheath	
E32-T11	 M4 threaded head x 11.7 mm (0.46 in) L	2 m	18 cm (7 in) 1 m (3.28 ft) with E39-F1	0.5 mm (0.02 in) dia.	PMMA	PE	1.5 mm ID fiber Ultra flexible cable
E32-T11L	 M4 threaded head x 11.7 mm (0.46 in) L		35 cm (13.8 in) 1 m (3.28 ft) with E39-F1 lens kit				1.4 mm ID fiber
E32-T12L	 3 mm dia. (0.12 in) x 14 mm (0.55 in)		35 cm (13.8 in)				1 mm ID fiber
E32-T17L	 M4 threaded head x 23 mm (0.91 in) L	10 m	7 m (23 ft)				1 mm ID fiber Long distance
E32-T21	 M3 threaded head x 11 mm (0.43 in) L	2 m	5 cm (1.97 in)	0.2 mm (0.01 in) dia.		Plastic extra flexible	0.5 mm ID fiber Ultra flexible cable
E32-T21L	 M3 threaded head x 9 mm (0.35 in) L		10 cm (3.94 in)				0.5 mm ID fiber
E32-T22	 2 mm dia. (0.8 in) x 22 mm (0.87 in)		5 cm (2 in)				0.5 mm ID fiber Easy to align
E32-T22L	 2 mm dia. (0.8 in) x 22 mm (0.87 in)		10 cm (3.94 in)				0.5 mm ID fiber
E32-TC50	 M4 threaded head x 14 mm (0.55 in) L	50 cm (19 in)	20 cm (7.88 in)				1 mm ID fiber
E32-TC200		2 m (6.4 ft)	1 m (3.28 ft) with E39-F1 lens kit				Low cost, general purpose
E32-TC500		5 m (16.4 ft)					
E32-TC1000		10 m (32.8 ft)					

Part Number	Appearance	Cable Length	Sensing Distance	Minimum Object Size	Fiber Material		Remarks
					Core	Sheath	
E32-TC200A	 M3 threaded head x 12.5 mm (0.49 in) L	2 m	12 cm (4.72 in)	0.2 mm (0.01 in) dia.	PMMA	PE	1 mm ID fiber
E32-TC200C	 M4 threaded head x 11 mm (0.43 in) L	Coiled 56.5 cm (22.2) L; 2 m extended	10 cm (3.9 in) 60 cm (2.0 ft) with E39-F1 lens kit				
E32-TC200E	 M3 threaded head x 11 mm (0.43 in) L	2 m	3.5 cm (1.38 in)				0.5 mm ID fiber Easy to align

### Armored Type

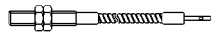
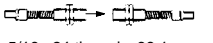
Part Number	Appearance	Cable Length	Sensing Distance	Minimum Object Size	Fiber Material		Remarks
					Core	Sheath	
E32-UTAT1-3F	 5/16 - 24 thread x 3.8 mm (1.5 in) L	0.91 m (3 ft)	20 cm (7.9 in)	0.2 mm (0.01 in) dia.	Glass	Stainless steel	General purpose Can withstand temperatures to 150°C (302°F)
E32-UTAT1-6F		1.83 m (6 ft)	17 cm (6.7 in)				
E32-UTBT1-3F*	 5/16 - 24 thread x 38.1 mm (1.5 in) L	0.91 m (3 ft)	40 cm (15.7 in)	0.25 mm (0.01 in) dia			General purpose Can withstand temperatures to 200°C (392°F)
E32-UTBT1-6F*		1.83 m (6 ft)					

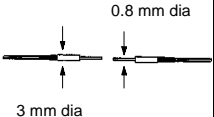
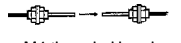
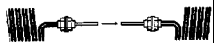
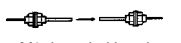

\*For use with E3JU-X only

### Probe Type

Part Number	Appearance	Cable Length	Sensing Distance	Minimum Object Size	Fiber Material		Remarks
					Core	Sheath	
E32-T33-1	 0.8 mm dia 3 mm dia	2 m	15 mm (0.59 in)	0.15 mm (0.06 in) dia.	PMMA	PE	0.25 mm ID fiber Ultra small sensing
E32-TC200B	 M4 threaded head		18 cm (7 in)				
E32-TC200B4					Probe = 40 mm		
E32-TC200D	 M4 threaded head	0.56 m (3.3 m) when extended	15 cm (5.9 in)				1 mm ID fiber Probe = 90 mm
E32-TC200D4							
E32-TC200F	 M3 threaded head	2 m	5 cm (2 in)				0.5 mm ID fiber Probe = 90 mm
E32-TC200F4							

## THROUGH-BEAM TYPE, CONTINUED

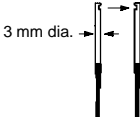
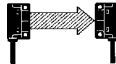

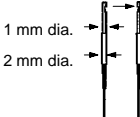
### Side Beam Type

Part Number	Appearance	Cable Length	Sensing Distance	Minimum Object Size	Fiber Material		Remarks
					Core	Sheath	
E32-T14		2 m	90 cm (3 ft)	0.1 mm (0.004 in) dia.	PMMA	PE	1 mm ID fiber Built-in lens offers long sensing distance
E32-T14L			12 cm (4.7 in)				1 mm ID fiber
E32-T16			75 cm (29 in)	—			1 mm ID fiber includes 0.5 mm and 1.0 mm slit masks
E32-T16P			20 cm (8 in)	—			
E32-T24			4.5 cm (1.8 in)	0.1 mm (0.004 in) dia.			0.5 mm ID fiber

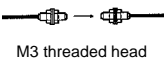
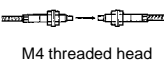
### High Temperature Type



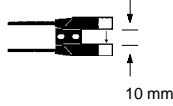
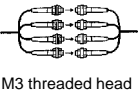
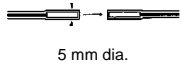
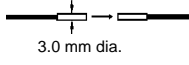
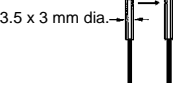







Part Number	Appearance	Maximum Temperature	Sensing Distance	Minimum Object Size	Fiber Material		Remarks
					Core	Sheath	
E32-T51	 M3 threaded head	150°C (302°F)	15 cm (5.9 in)	1 mm (0.04 in) dia.	PMMA	PE	1.5 mm ID fiber
E32-T61	 M4 threaded head	300°C (572°F)	15 cm (5.9 in) 1.5 m (4.9 ft) with E39-F1 lens	0.2 mm (0.01 in) dia.	Glass	SUS 304	1 mm ID fiber

### Special Purpose Type

Part Number	Appearance	Cable Length	Sensing Distance	Minimum Object Size	Fiber Material		Remarks	
					Core	Sheath		
E32-G14	 10 mm	2 m	10 mm (0.39 in)	0.5 mm (0.02 in) dia.	PMMA	PE	1 mm ID fiber Ideal for mark sensing or belt alignment	
E32-M21	 M3 threaded head		15 cm (6 in)	0.3 mm (0.01 in) dia.			0.5 mm ID fiber Use with E3XA-CC4A for shape recognition	
E32-T12F	 5 mm dia.		60 cm (23.6 in)	0.9 mm (0.04 in) dia.			Teflon®	1 mm ID fiber Ideal for harsh chemical environments
E32-T22S	 3.0 mm dia.		500 mm	0.5 mm (0.02 in) dia.			PVC	Ideal for sensing silicon wafers Ultra-narrow beam
E32-T24S	 3.5 x 3 mm dia.		350 mm					Side-view Ideal for sensing silicon wafers Ultra-narrow beam
E32-T84S			450-480 mm	0.3 mm			Glass	SUS 304

## ■ DIFFUSE TYPE

### General Purpose

Part Number	Appearance	Cable Length	Sensing Distance	Minimum Object Size	Fiber Material		Remarks
					Core	Sheath	
E32-CC200	 M6 threaded head x 20 mm (0.79 in) L	2 m	7.5 cm (3 in)	0.03 mm (0.001 in) dia.	PMMA	PE	1 mm ID fiber Concentric beam
E32-D11	 M6 threaded head x 17 mm (0.67 in) L		4.5 cm (1.8 in)				0.25 mm ID fiber Ultra-flexible cable
E32-D11L	 M6 threaded head x 17 mm (0.67 in) L		10 cm (4 in)	0.015 mm (0.0006 in) dia.			1 mm ID fiber Long distance
E32-D21	 M3 threaded head x 11 mm (0.43 in) L		0.7 cm (0.28 in)	0.03 mm (0.001 in) dia.			0.25 mm ID fiber Ultra-flexible cable
E32-D21L	 M4 threaded head x 12 mm (0.47 in) L		2.5 cm (1 in)				0.5 mm ID fiber
E32-D22L	 3 mm (0.12 in) dia. x 15 mm (0.59 in) L		2 cm (0.79 in)	0.25 mm ID fiber Concentric beam			
E32-D32	 2 mm dia.						
E32-D32L	 3 mm dia.		4 cm (1.57 in)	0.04 mm (0.002 in) dia.			Long distance Concentric beam
E32-DC50	 M6 threaded head x 12 mm (0.47 in) L	0.5 m (19 in)	7.5 cm (3 in)	0.015 mm (0.0006 in) dia.	1 mm ID fiber Low cost, general purpose		
E32-DC200		2 m (6.4 ft)					
E32-DC500		5 m (16.4 ft)					
E32-DC1000		10 m (32.8 ft)					
E32-DC200C	 M6 threaded head x 17 mm (0.67 in) L	0.64 m 2.49 m when extended	7.5 cm (3 in)	0.03 mm (0.001 in) dia.	1 mm ID fiber		
E32-DC200E	 M3 threaded head x 11 mm (0.43 in) L	2 m	1.8 cm (0.71 in)		0.5 mm ID fiber		

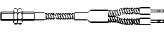
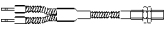

### Armored Type

Part Number	Appearance	Cable Length	Sensing Distance	Minimum Object Size	Fiber Material		Remarks		
					Core	Sheath			
E32-UDAT1-3F	 5/16 - 24 thread x 38.1 mm (1.5 in) L	0.91 m (3 ft)	8 cm (3.1 in)	0.03 mm (0.001 in) dia.	Glass	Stainless steel	General purpose Can withstand temperatures to 150°C (302°F)		
E32-UDAT1-6F		1.83 m (6 ft)	6.5 cm (2.6 in)						
E32-UDBT1-3F*	 5/16 - 24 thread x 38.1 mm (1.5 in) L	0.91 m (3 ft)	9 cm (3.5 in)	0.05 mm. (0.002 in) dia			Glass	Stainless steel	General purpose Can withstand temperatures to 200°C (392°F)
E32-UDBT1-6F*		1.83 m (6 ft)	8 cm (3.1 in)						

\*For use with E3JU-X only

## ■ DIFFUSE TYPE, CONTINUED

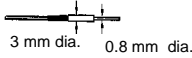
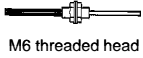
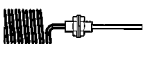
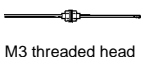
### Probe Type

Part Number	Appearance	Cable Length	Sensing Distance	Minimum Object Size	Fiber Material		Remarks
					Core	Sheath	
E32-D33	 3 mm dia. 0.8 mm dia.	2 m	5 mm (0.2 in)	0.015 mm (0.0006 in) dia.	PMMA	PE	0.25 mm ID fiber Ultra small sensing
E32-DC200B	 M6 threaded head		7.5 cm (3 in)				1 mm ID fiber Probe = 90 mm
E32-DC200B4							Probe = 40 mm
E32-DC200D	 M6 threaded head	0.64 m (2.49 when extended)	2.2 cm (0.87 in)				1 mm ID fiber Probe = 90 mm
E32-DC200D4							Probe = 40 mm
E32-DC200F	 M3 threaded head	2 m	1.8 cm (0.71 in)				0.5 mm ID fiber Probe = 90 mm
E32-DC200F4							
E32-DC9G		No cable	3 cm (1.2 in)			N/A	1 mm ID fiber Probe = 90 mm
E32-DC9G4	1.2 mm dia.						



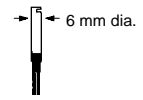
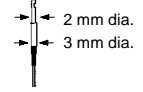

### Side Beam Type

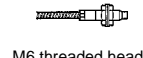
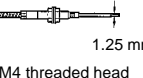
Part Number	Appearance	Cable Length	Sensing Distance	Minimum Object Size	Fiber Material		Remarks
					Core	Sheath	
E32-D14L	 6 mm dia.	2 m	4 cm (1.6 in)	0.03 mm (0.001 in) dia.	PMMA	PE	1 mm ID fiber
E32-D24	 2 mm dia. 3 mm dia.		1.5 cm (0.6 in)				0.5 mm ID fiber

### High Temperature Type

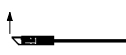
Part Number	Appearance	Maximum Temperature	Sensing Distance	Minimum Object Size	Fiber Material		Remarks
					Core	Sheath	
E32-D51	 M6 threaded head	150°C (302°F)	6 cm (2.4 in)	0.03 mm (0.001 in) dia.	PMMA	PE	1.5 mm ID fiber
E32-D61	 M6 threaded head	300°C (572°F)	4.5 cm (1.8 in)		Glass	SUS 304	1.4 mm ID fiber
E32-D73	 1.25 mm dia. M4 threaded head	400°C (752°F)	3 cm (1.2 in)				1 mm ID fiber

### Convergent Type and Special Purpose

Part Number	Appearance	Cable Length	Sensing Distance	Minimum Object Size	Fiber Material		Remarks
					Core	Sheath	
E32-D12F	 6-mm dia.	2 m	5 cm (2 in)	0.03 mm (0.01 in) dia.	PMMA	Teflon®	1 mm ID fiber Ideal for harsh chemical environ- ments
E32-L24L			4 ±2 mm (0.16 ±0.07 in)	0.15 mm (0.006 in) dia.		PE	Side view Convergent beam Ideal for sensing silicon wafers
E32-L25			3.3 mm (0.13 in)	0.25 mm (0.01 in) dia.			Convergent beam Ideal for sensing silicon wafers
E32-L25A							
E32-L25L			7.2 ±1.8 mm (0.28 ±0.07 in)	0.15 mm (0.006 in) dia.			

### ■ RETROREFLECTIVE TYPE

#### Special Purpose

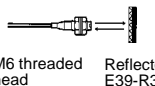
Part Number	Appearance	Cable Length	Sensing Distance	Minimum Object Size	Fiber Material		Remarks
					Core	Sheath	
E32-R16	 Reflector E39-R1	2 m	15 to 150 cm (5.91 to 59.05 in) with E39-R1 reflector	0.03 mm (0.001 in) dia.	PMMA	PE	For detection of shiny transparent or opaque objects E39-R1 included
E32-R21	 M6 threaded head Reflector E39-R3		1 to 25 cm (0.39 to 9.84 in) with E39-R3 reflector				For detection of shiny transparent or opaque objects E39-R3 included

# Specifications

## ■ FIBER UNIT

### Through-beam (Separate) Sensors

Part Number	Operating Ambient Temperature	Operating Ambient Humidity	Permissible Bending Radius	Sheath Material	Enclosure Rating	
E32-M21	-40°C to 70°C (-40°F to 158°F) with no icing	35% to 85%	25 mm min.	Black polyethylene	IEC IP67	
E32-T11			4 mm min.	Vinyl chloride		
E32-T11L			25 mm min.	Black polyethylene		
E32-T12F	-30°C to 70°C (-22°F to 158°F) with no icing		40 mm min.	Teflon-covered black polyethylene		
E32-T12L	-40°C to 70°C (-40°F to 158°F) with no icing		25 mm min.	Black polyethylene		
E32-T14						
E32-T14L						
E32-T16						
E32-T16P			10 mm min.	Vinyl chloride		IEC IP50
E32-T17L			25 mm min.	Black polyethylene		IEC IP67
E32-T21			4 mm min.	Vinyl chloride		
E32-T21L			25 mm min.	Black polyethylene		
E32-T22						
E32-T22L						
E32-T24						
E32-T51	-40°C to 150°C* (-40°F to 302°F) with no icing	35 mm min.	Fluoride resin			
E32-T61	-40°C to 300°C (-40°F to 572°F) with no icing	25 mm min.	SUS			
E32-TC200	-40°C to 70°C (-40°F to 158°F) with no icing		Black polyethylene			
E32-TC200A						
E32-TC200B						
E32-TC200B4						
E32-TC200C						
E32-TC200D						
E32-TC200D4						
E32-TC200E						
E32-TC200F						
E32-TC200F4						

\*When used continuously between -40°C and 130°C (-40°F and 266°F)



## Reflective Sensors

Part Number	Differential Travel	Operating Ambient Temperature	Operating Ambient Humidity	Permissible Bending Radius	Material	Enclosure Rating			
E32-CC200	20% of max. detection sensing distance (Adjustable in a range of 0% to 20% when the E3X-H11 is used.)	-40°C to 70°C (-40°F to 158°F) with no icing	35% to 85%	25 mm min.	Black polyethylene	IEC IP67			
E32-D11				4 mm min.	Vinyl chloride				
E32-D11L				25 mm min.	Black polyethylene				
E32-D12F		-30°C to 70°C (-22°F to 158°F) with no icing		40 mm min.	Teflon-covered black polyethylene*				
E32-D14L		-40°C to 70°C (-40°F to 158°F) with no icing		25 mm min.	Black polyethylene				
E32-D21				4 mm min.	Vinyl chloride				
E32-D21L				25 mm min.	Black polyethylene				
E32-D22L									
E32-D24									
E32-D32									
E32-D32L									
E32-D33									
E32-D51							-40°C to 150°C (-40°F to 302°F) with no icing**	35 mm min.	Fluoride resin
E32-D61							-40°C to 300°C (-40°F to 572°F) with no icing	25 mm min.	SUS
E32-D73		-40°C to 400°C (-40°F to 752°F) with no icing							
E32-DC200		-40°C to 70°C (-40°F to 158°F) with no icing		10 mm min. (average at 10% decrease of sensing distance)	Reinforced polyethylene		IEC IP50		
E32-DC200B E32-DC200B4									
E32-DC200C									
E32-DC200D E32-DC200D4									
E32-DC200E									
E32-DC200F E32-DC200F4									
E32-DC9G E32-DC9G4									
E32-L24L***									

\*Teflon is a registered trademark of the Dupont Company and the Mitsui Dupont Chemical Company for their fluoride resin.

\*\*When used continuously between -40°C and 130°C (-40°F and 266°F)

\*\*\*Beam size: 2 mm dia.

Part Number	Differential Travel	Operating Ambient Temperature	Operating Ambient Humidity	Permissible Bending Radius	Material	Enclosure Rating
E32-L25	20% of max. detection sensing distance (Adjustable in a range of 0% to 20% when the E3X-H11 is used.)	-40°C to 70°C (-40°F to 158°F) with no icing	35% to 85%	25 mm min.	Black polyethylene	IEC IP50
E32-L25A						
E32-L25L***		-40°C to 105°C (-40°F to 221°F) with no icing		10 mm min. (average at 10% decrease of sensing distance)	Reinforced polyethylene	
E32-R16 E39-R1		-25°C to 55°C (-13°F to 131°F) with no icing		25 mm min.	Black polyethylene	IEC IP66
E32-R21 E39-R3	-40°C to 70°C (-40°F to 158°F) with no icing				IEC IP67	

\*Teflon is a registered trademark of the Dupont Company and the Mitsui Dupont Chemical Company for their fluoride resin

\*\*When used continuously between -40°C and 130°C (-40°F and 266°F)

\*\*\*Beam size: 2 mm dia.

### Fine Through-beam Sensors

Part Number	Beam Size	Differential Travel	Horizontal Positioning Accuracy	Operating Ambient Temperature	Operating Ambient Humidity	Permissible Bending Radius*	Material	Enclosure Rating
E32-T22S	13 mm dia. (at a distance of 200 mm)	---	---	-40°C to 70°C (-40°F to 158°F) with no icing	35% to 85%	10 mm min.	Reinforced laminated vinyl chloride	IEC IP67
E32-T24S								
E32-T84S				-40°C to 200°C (-40°F to 392°F) with no icing		25 mm min.	SUS	

\*Average at 30% of sensing distance

### Slot Sensors

Part Number	Operating Ambient Temperature	Operating Ambient Humidity	Permissible Bending Radius	Material	Enclosure Rating
E32-G14	-40°C to 70°C (-40°F to 158°F) with no icing	35% to 85%	25 mm min.	Black polyethylene	IEC IP67

# Engineering Data

## ■ EXCESS GAIN RATIO

### Through-beam Type

**E32-T22**

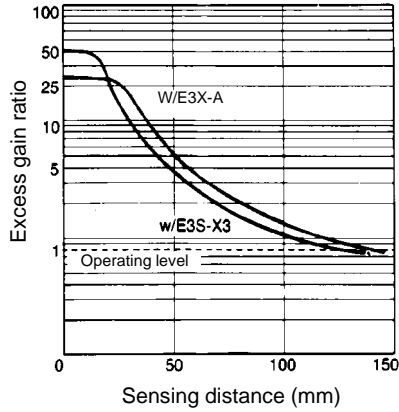

**E32-T21L, E32-T22L**

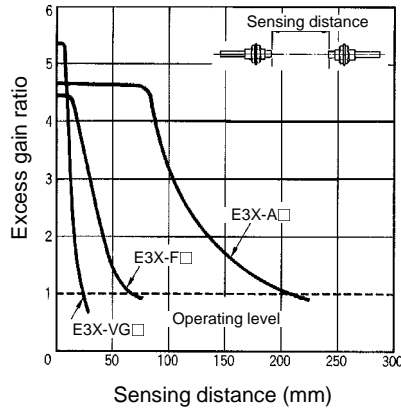

**E32-T11L, E32-T12L**

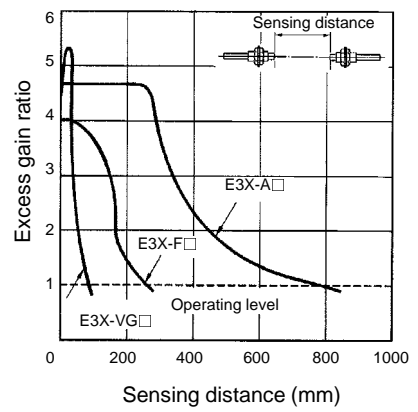

**E32-TC200E, E32-TC200F, E32-TC200F4**

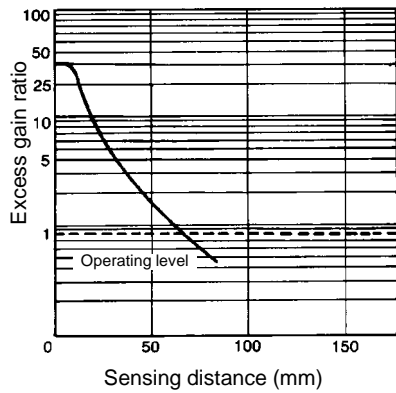

**E32-T21**

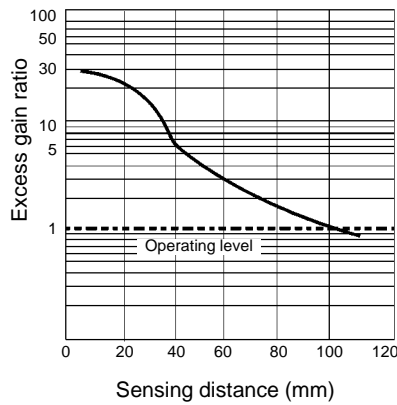

**E32-TC50/200/500/1000, E32-TC200A, E32-TC200B, E32-TC200B4**

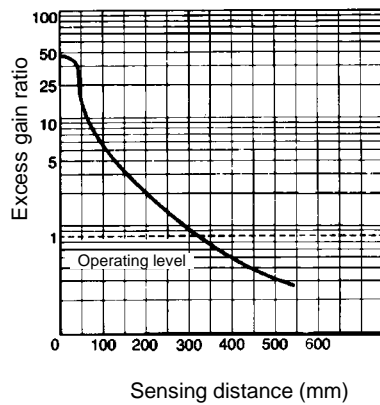

**E32-TC200 + E39-F1**

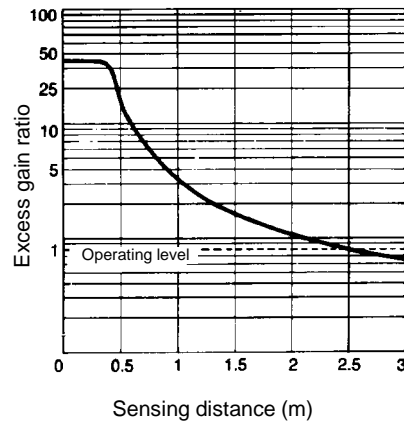

**E32-TC200 + E39-F2**

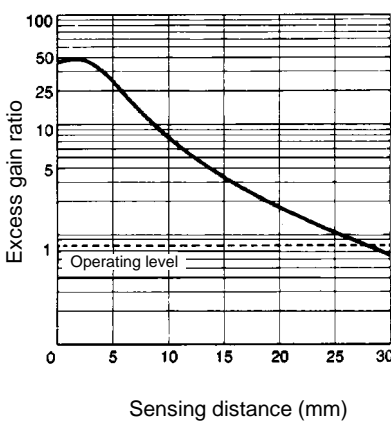

**E32-T11**

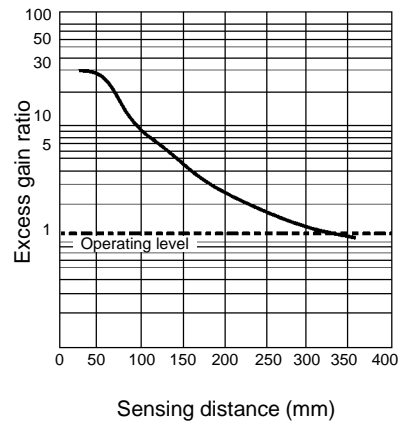

E32-UTAT1-3F

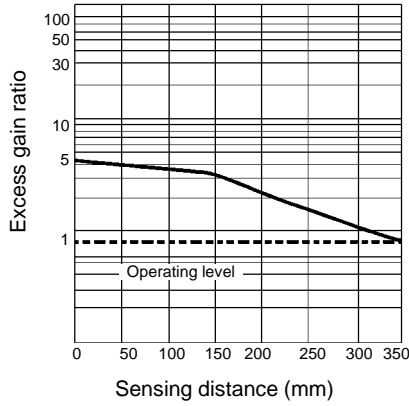

E32-UTAT1-6F

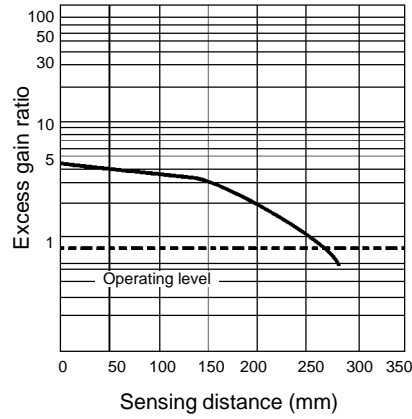

E32-T17L

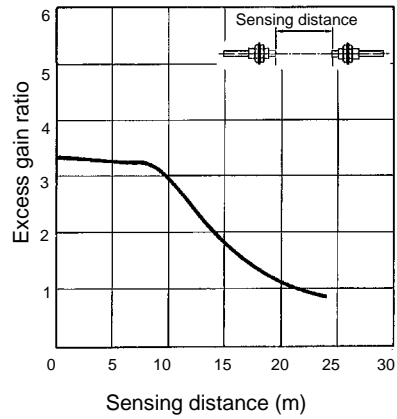

E32-M21

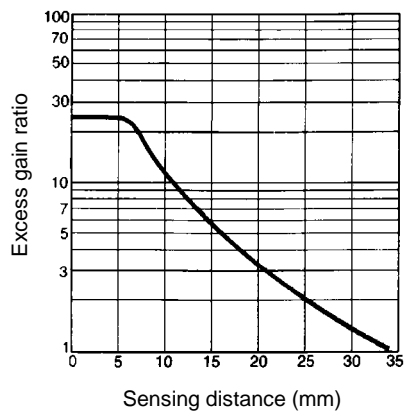

E32-TC200B  
E32-TC200B4

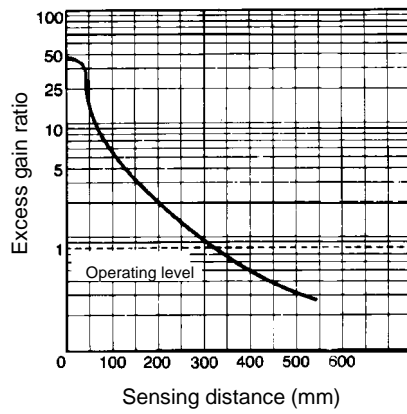

E32-T24

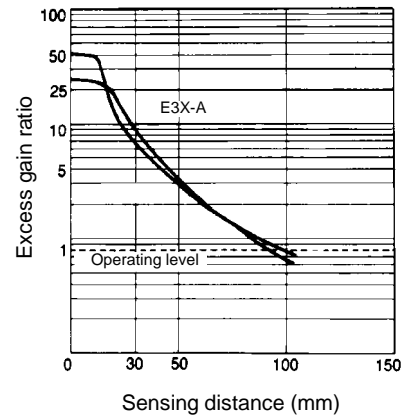

E32-T14L

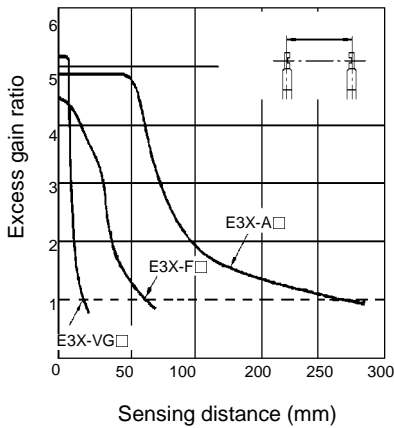

E32-T14

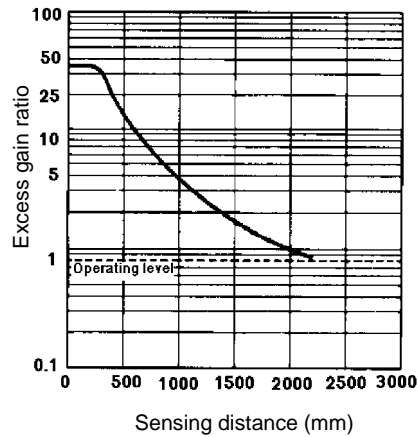

E32-T16

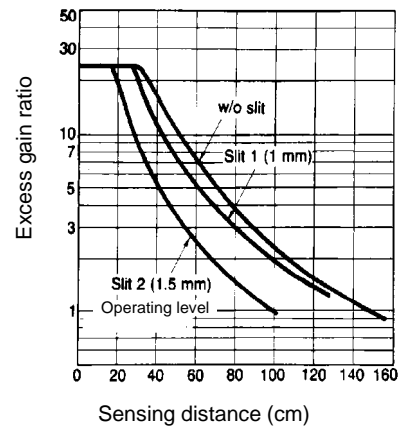

E32-T51

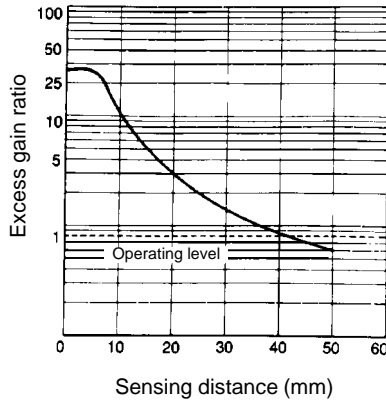

E32-T61

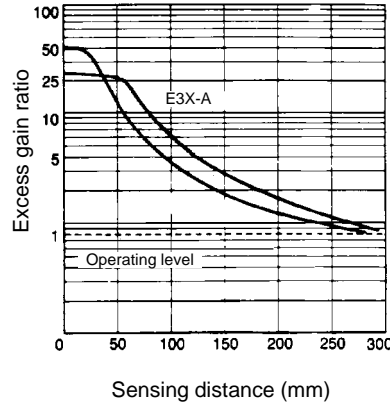

E32-T12F

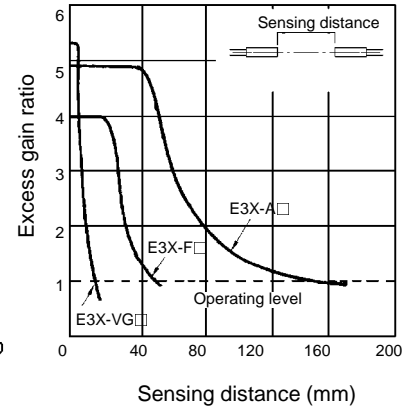

Diffuse Type

E32-D32, E32-DC9G

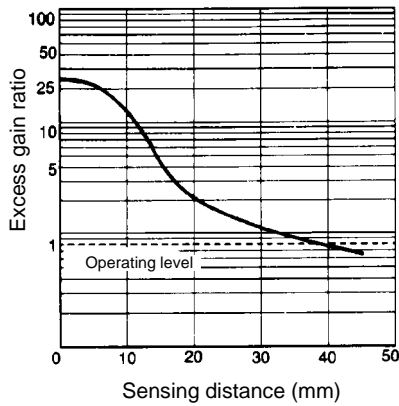

E32-D21L, E32-D22L

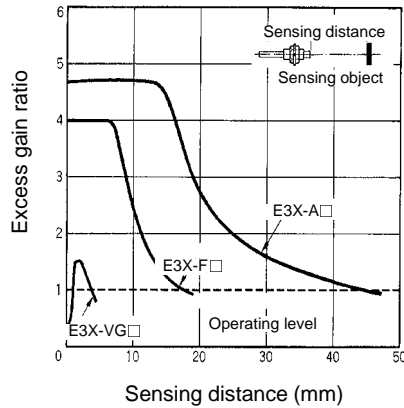

E32-D21

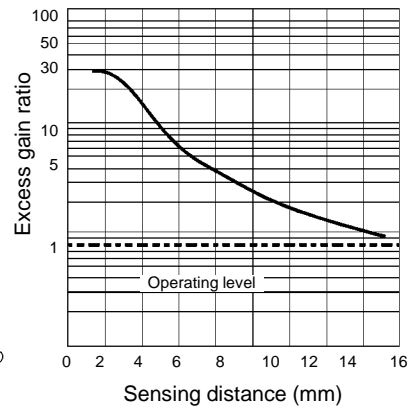

E32-DC50, E32-DC200,  
E32-DC500, E32-DC1000

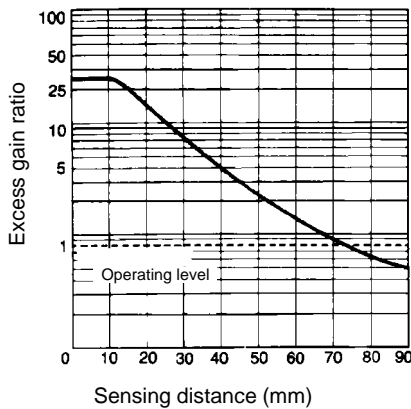

E32-D11

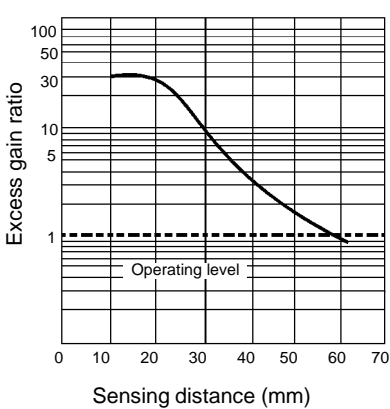

E32-D11L

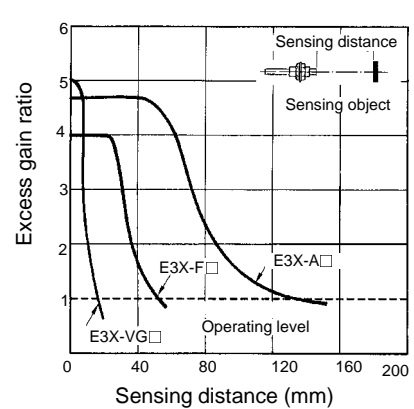

E32-UDAT1-3F

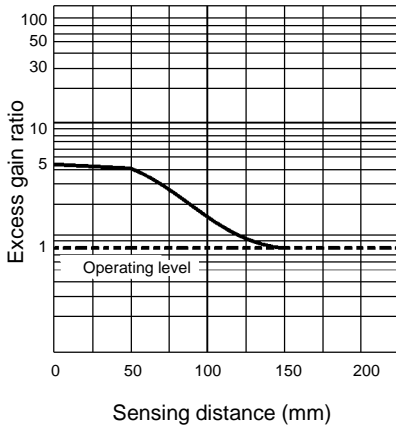

E32-UDAT1-6F

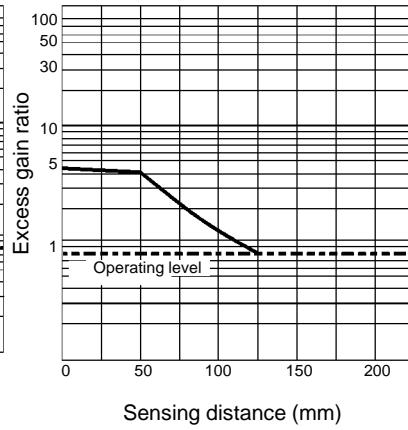

E32-D33

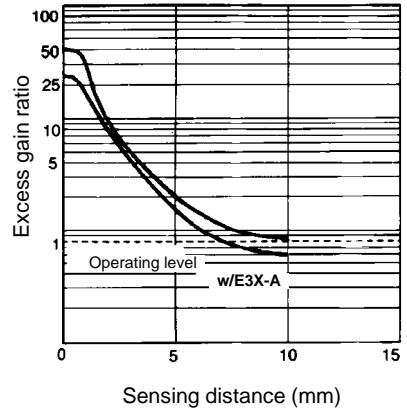

E32-D24

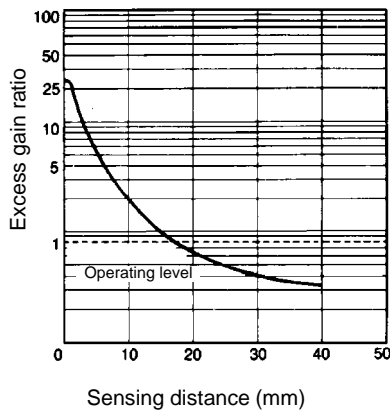

E32-D14L

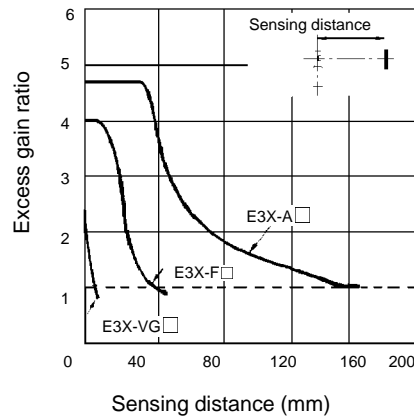

E32-D51

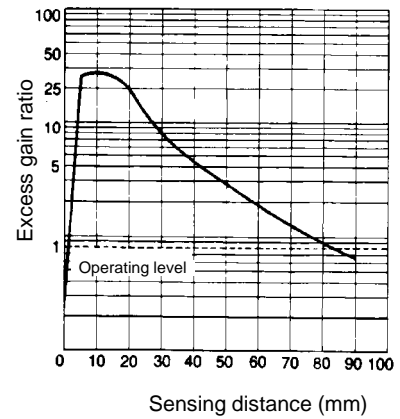

E32-D61

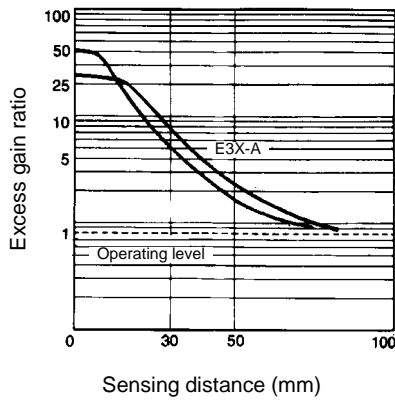

E32-D73

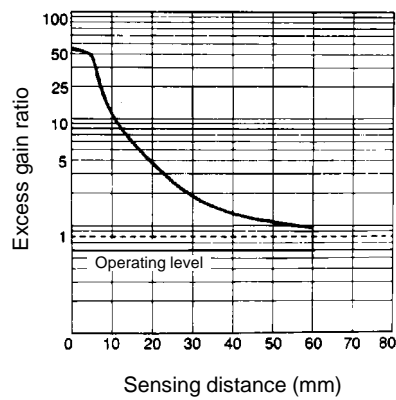

E32-D12F

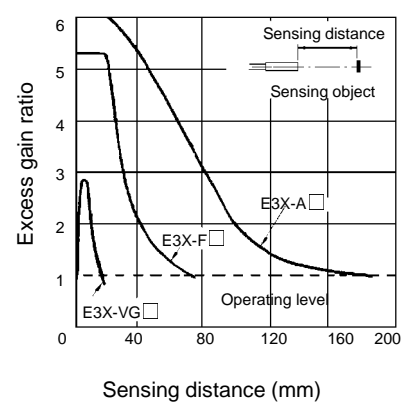

**Convergent Type**

**E32-L25, E32-L25A**

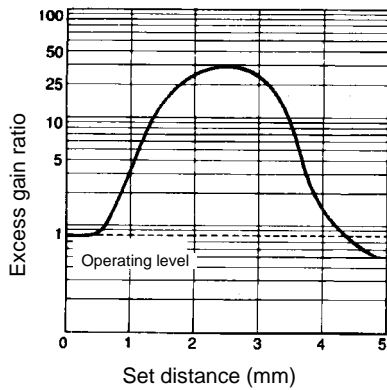

**Retroreflective Type**

**E32-R21**

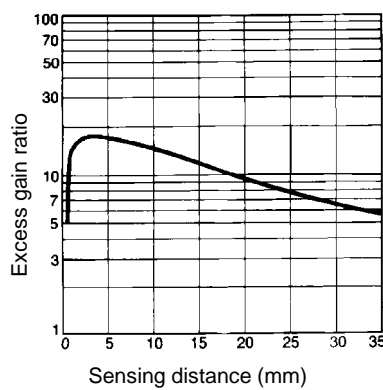

**E32-R16**

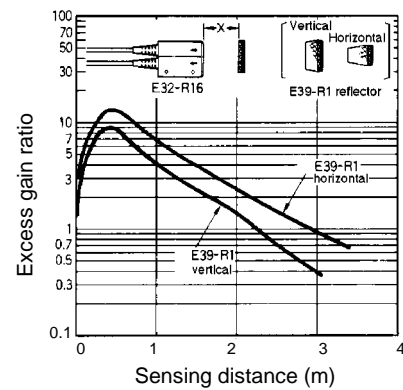

**OPERATING RANGE**

**Through-beam Type**

Operating range with E3X-A11 amplifier

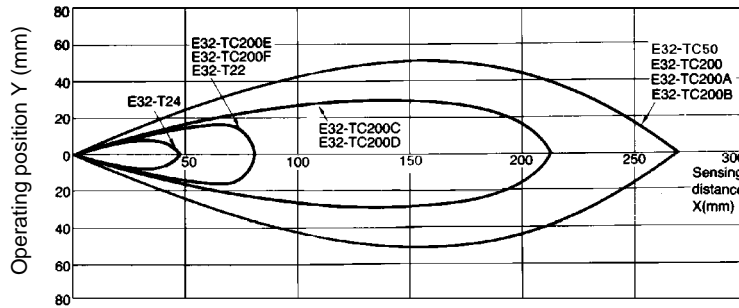

**E32-T11L + E39-F3**

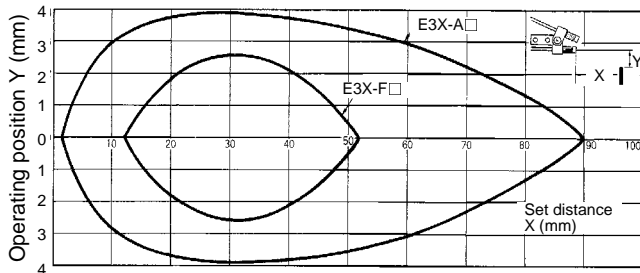

Note: With E3X-A: Adjust the angle of E39-F3 so that the sensor can detect an object at a distance of 90 mm. (For E3X-F: 50 mm).

**E32-T22, E32-T24 with E3X-A11 amplifier**

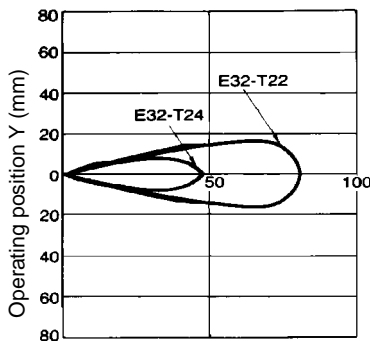

**E32-T14 with E3X-A11 amplifier**

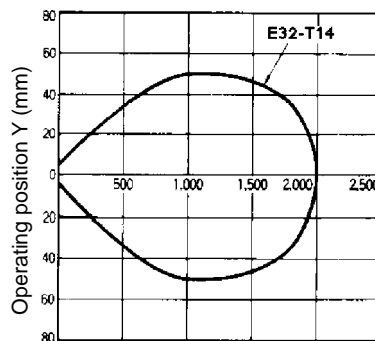

**E32-T16 with E3X-A11 amplifier**

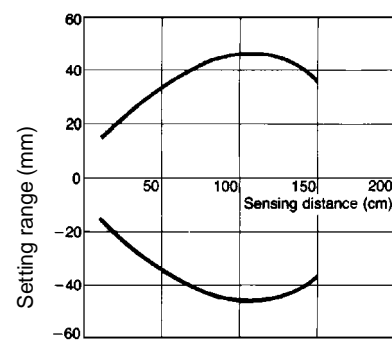

**E32-T51, E32-T61  
with E3X-A11 amplifier**

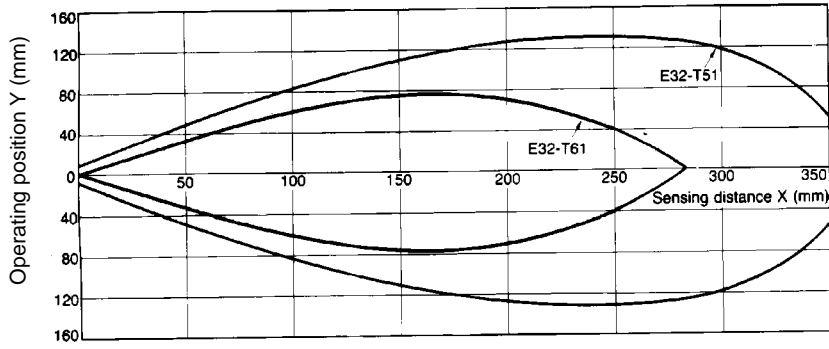

**E32-M21  
with E3X-A11 amplifier**

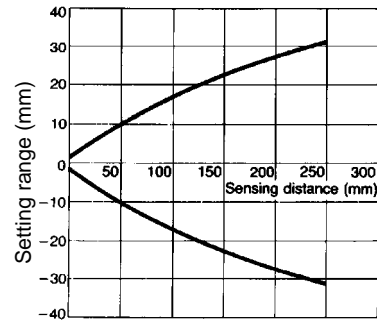

**Diffuse Type**

**E32-D21L, E32-D22L**

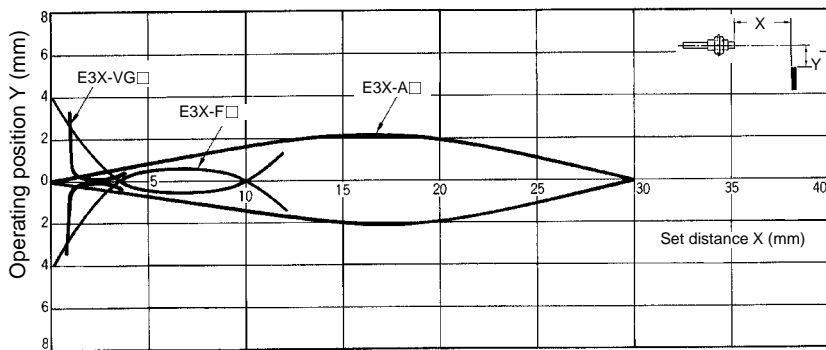

**E32-D11L**

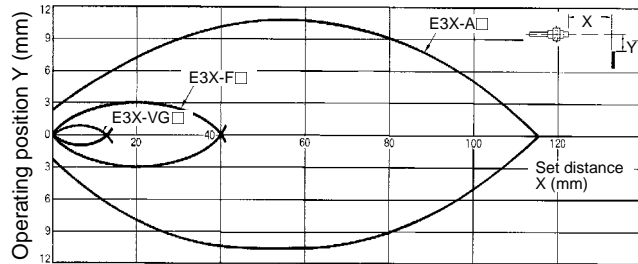

**E32-DC200C**

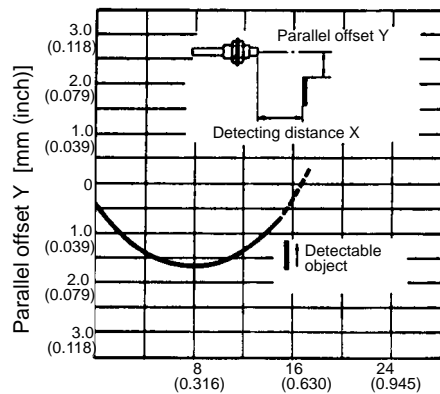

Detecting distance X [mm (inch)] with 5 x 5 cm (2 x 2 in) 90% reflective mat paper

**Operating range with E3X-A11 amplifier**

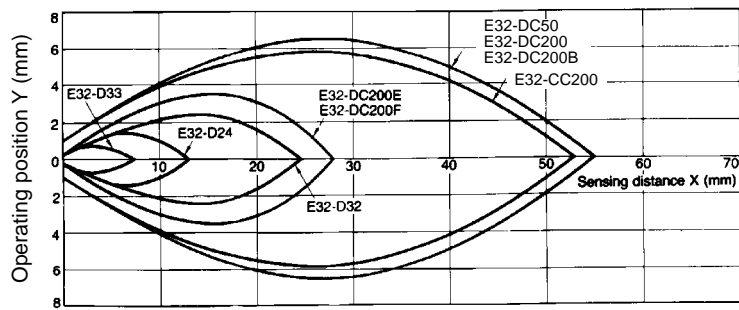



**E32-D12F**

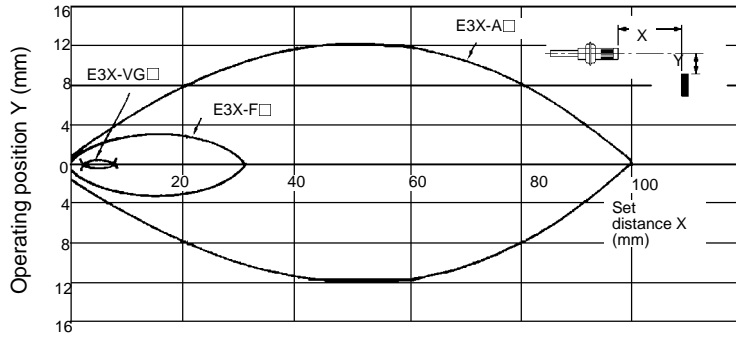

**E32-UDAT1-3F with E3X-A amplifier**

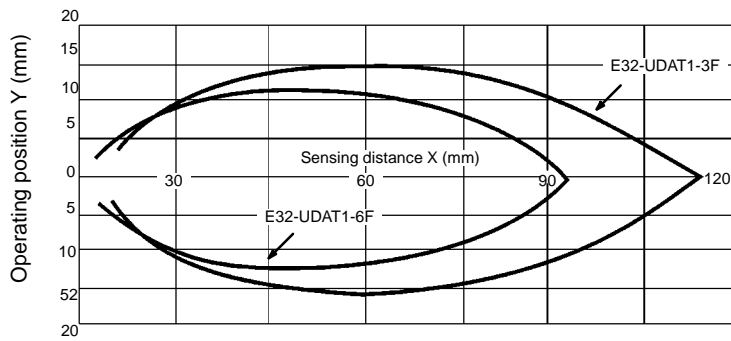

**E32-D24, E32-D32, E32-D33**

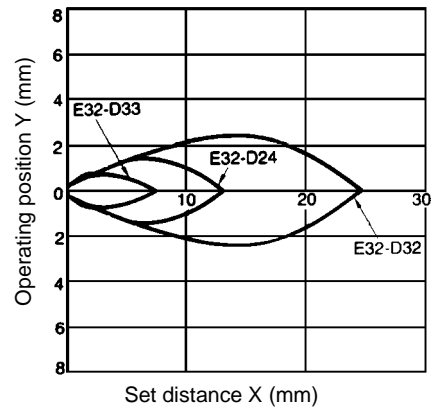

**E32-D14L**

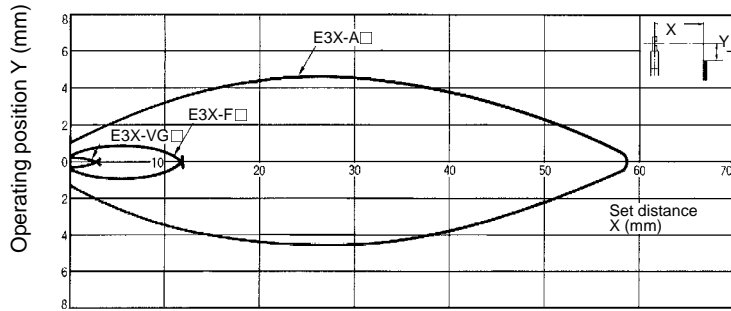

**E32-D51, E32-D61, E32-D73**

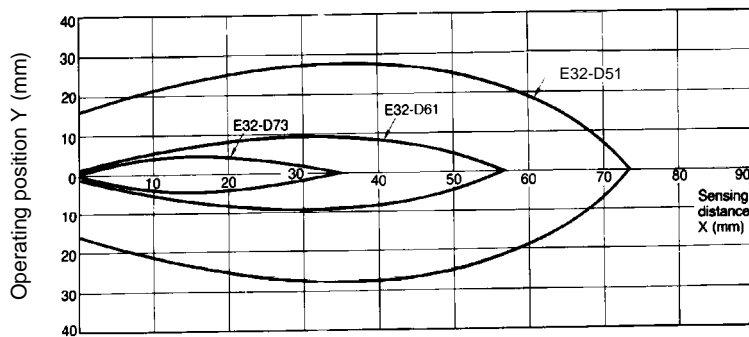

**Convergent Type**

E32-L25, E32-L25A

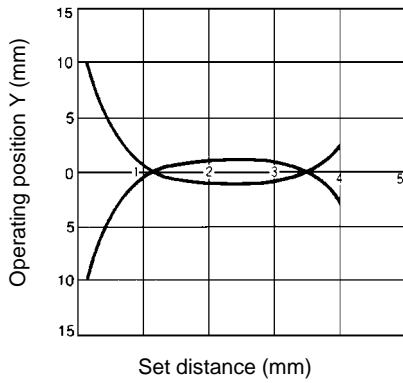

**Retroreflective Type**

E32-R21 with E3X-A11 amplifier

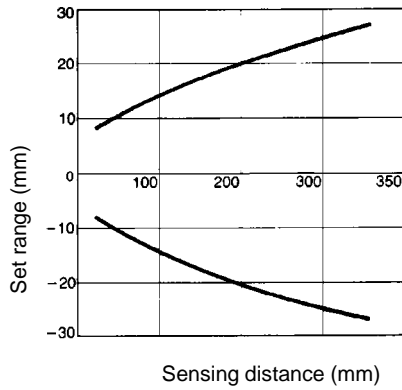

**Dimensions**

Unit: mm (inch)

**THROUGH-BEAM TYPE**  
(Sold in pairs)

**General Purpose**

E32-T11

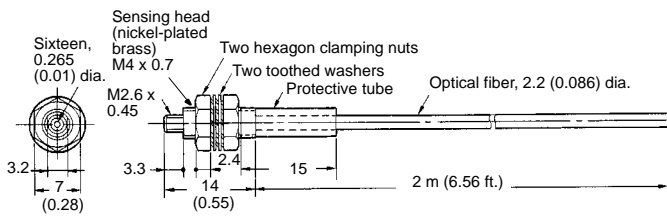

E32-T11L

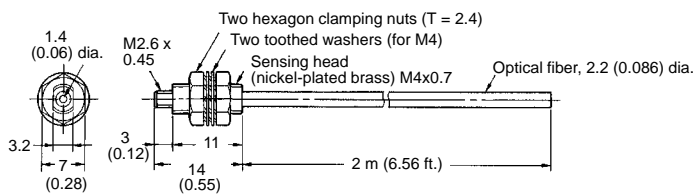

E32-T12L

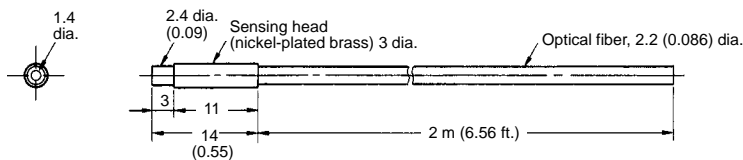

E32-T17L

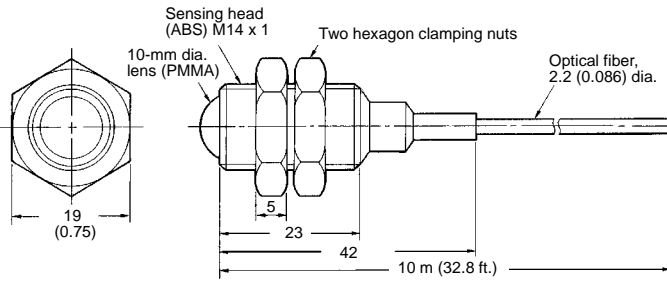

E32-T21

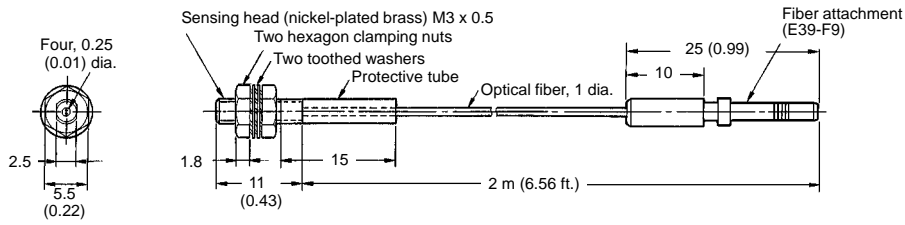

E32-T21L

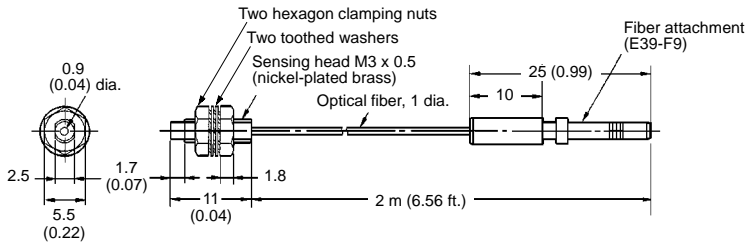

E32-T22

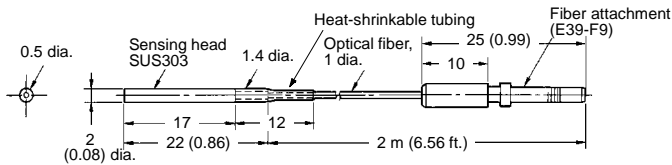

E32-T22L

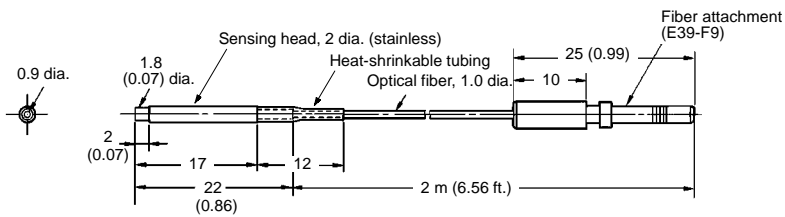

**E32-TC50, E32-TC200, E32-TC500,  
E32-TC1000**

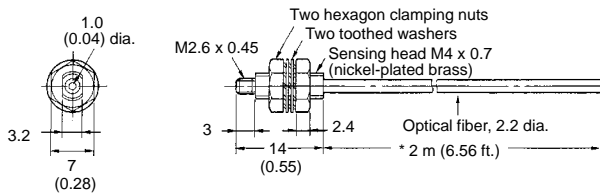

\* This length is 50 cm for E32-TC50, 5 m for E32-TC500 and 10 m for E32-TC10000.

**E32-TC200A**

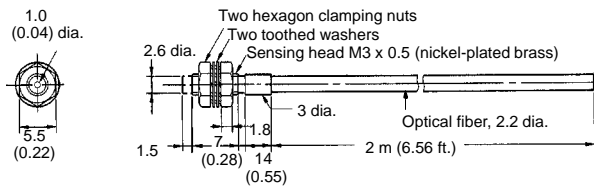

**E32-TC200C**

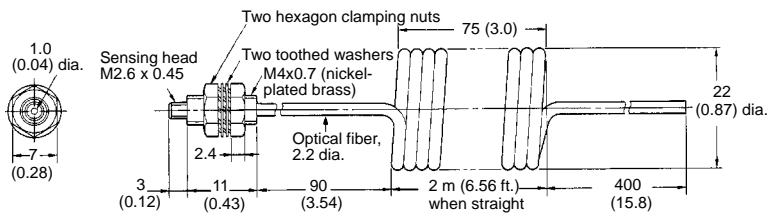

**E32-TC200E**

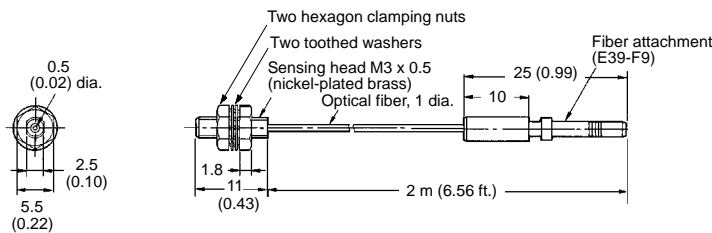

**Armored Type**

**E32-UTAT1-3F  
E32-UTAT1-6F**

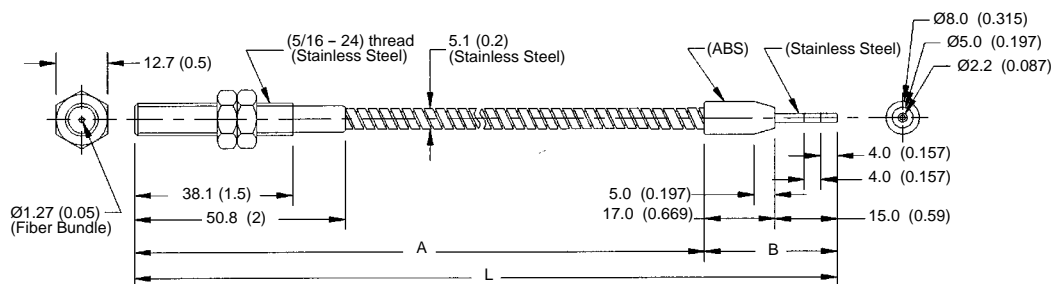

Note: Distance A can withstand 150°C (302°F); Distance B can withstand 70°C (158°F);  
L=3ft. or 6ft.

**E32-UTBT1-3F**  
**E32-UTBT1-6F**

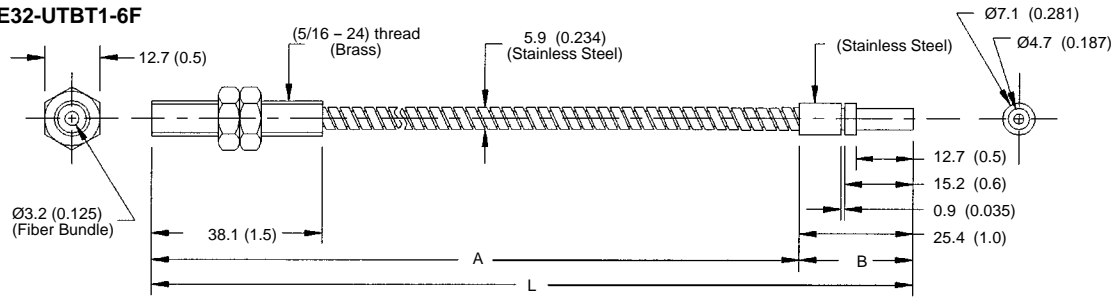

Note: Distance A can withstand 200°C (392°F); Distance B can withstand 70°C (158°F);  
L=3ft. or 6ft.

**Probe Type**

**E32-T33-1**

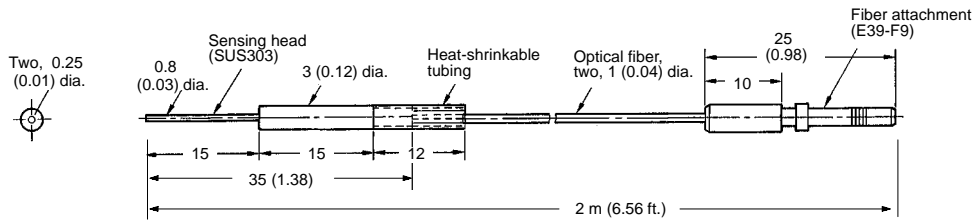

**E32-TC200B**  
**E32-TC200B4**

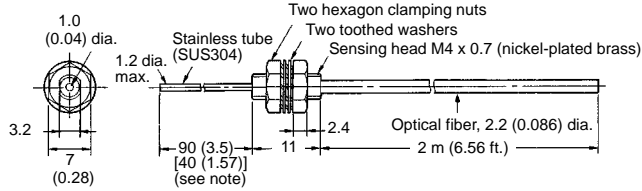

Note: The values in the brackets are for the E32-TC200B4.

**E32-TC200D**  
**E32-TC200D4**

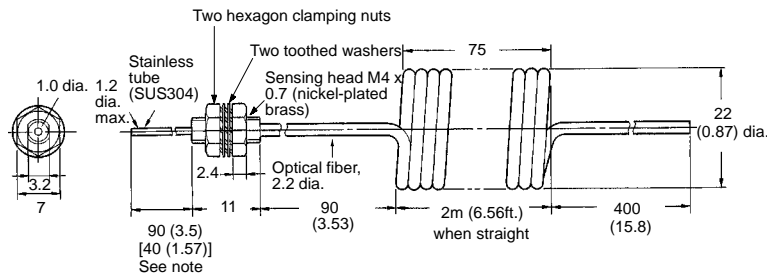

Note: The values in the brackets are for the E32-TC200D4.

**E32-TC200F**  
**E32-TC200F4**

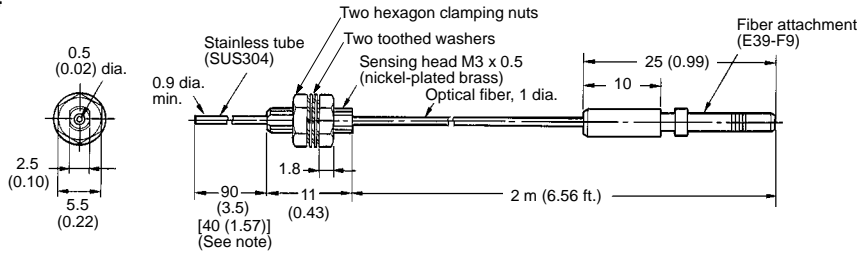

Note: The values in the brackets are for the E32-TC200F4.

**Side Beam Type**

**E32-T14**

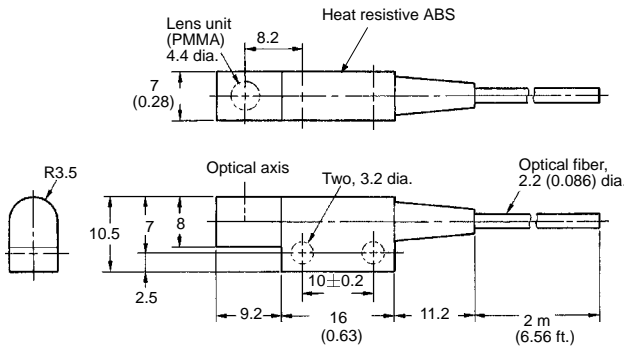

**E32-T14L**

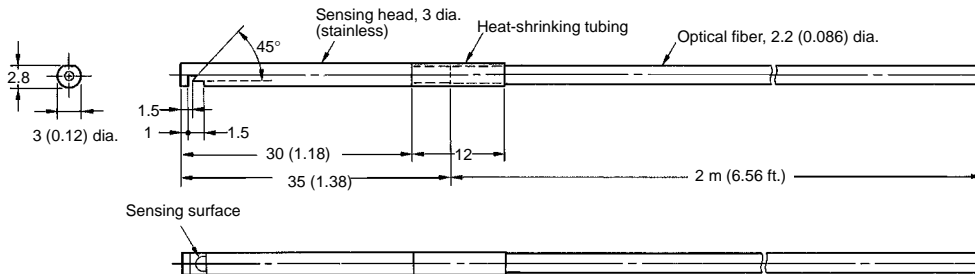

E32-T16

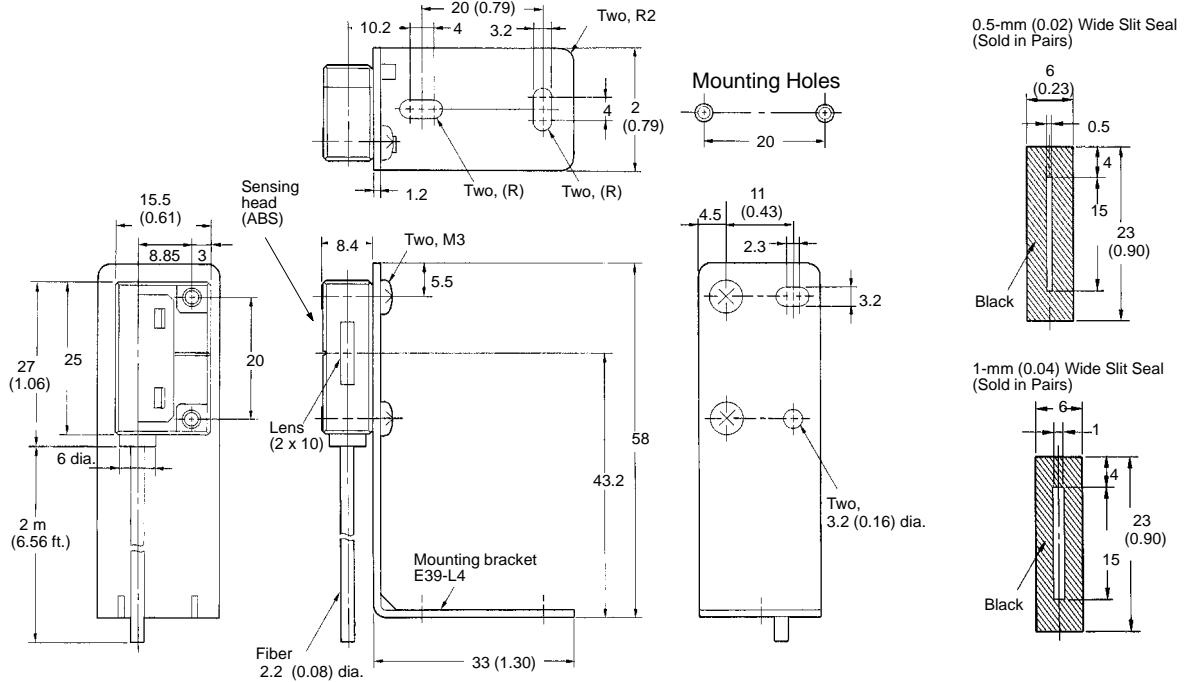

E32-T16P

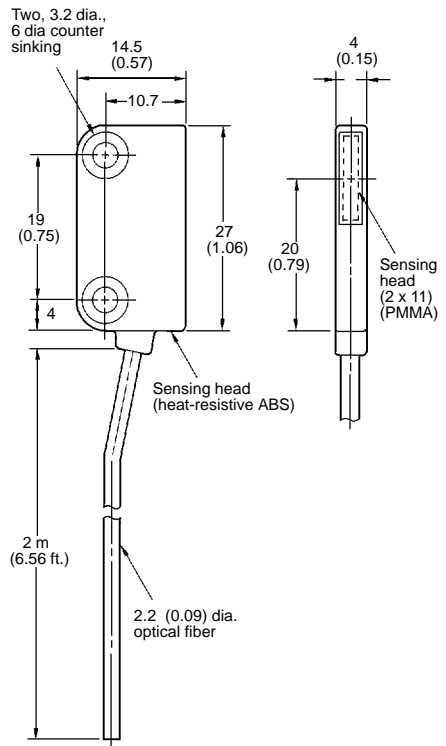

0.5-mm (0.02) wide Seal Slit (Two slits are provided)

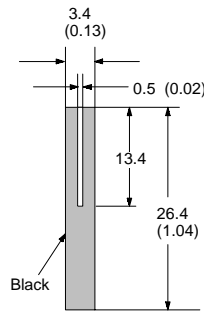

1-mm (0.04) wide Seal Slit (Two slits are provided)

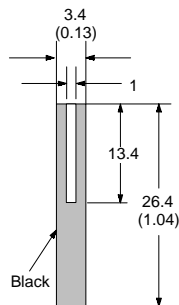

E32-T16P + E39-L94 Mounting

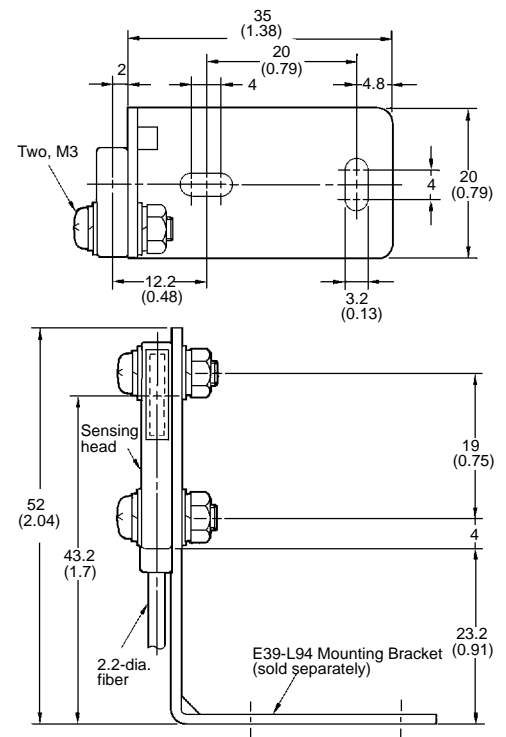

E32-T24

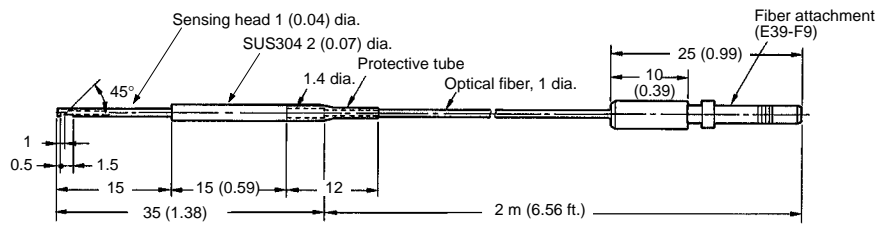

High Temperature Type

E32-T51

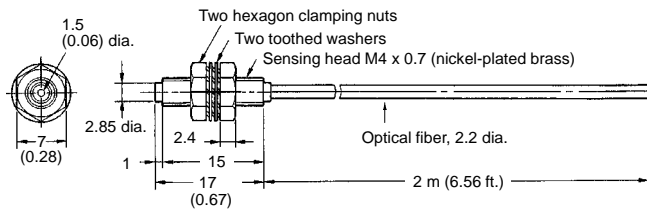

Note: Resistant temperature is 150°C (302°F). Resistant temperature is 130°C (266°F) when used continuously.

E32-T61

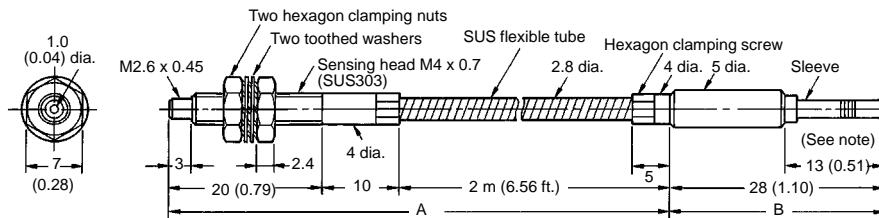

Note: Section A resists 300°C and section B (which is inserted to the amplifier) resists 110°C. The operating temperature of section B must also be within the withstand temperature range of the amplifier.

Special Purpose

E32-G14

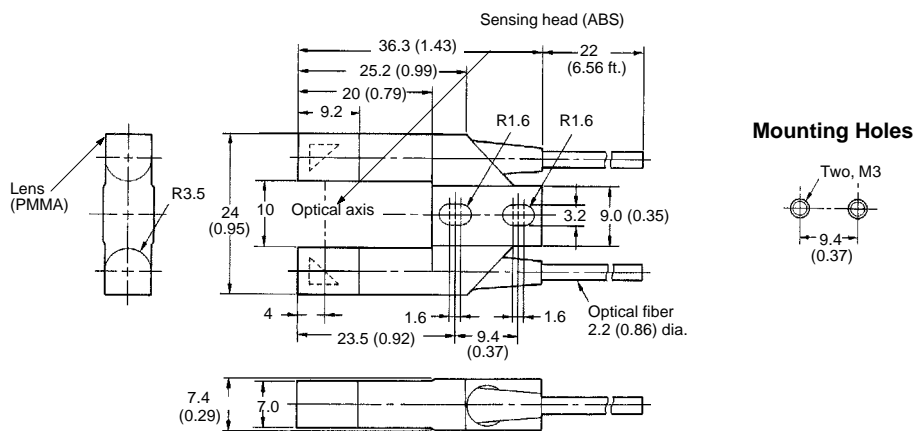



**E32-M21**

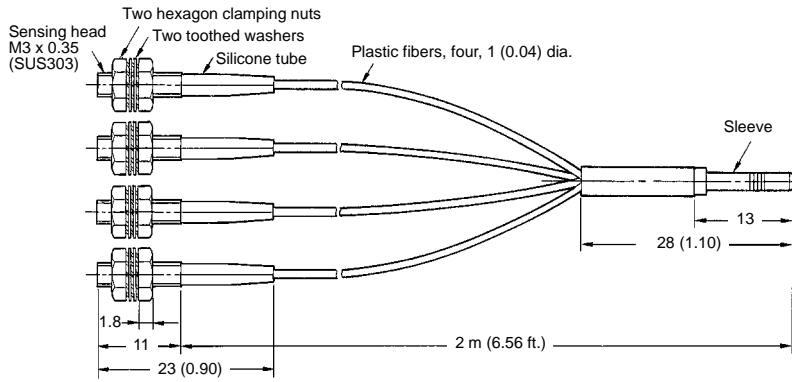

Note: One set of silicone tubes is black while the other set is gray for easy identification when they are connected to the light source and receiver.

**E32-T12F**

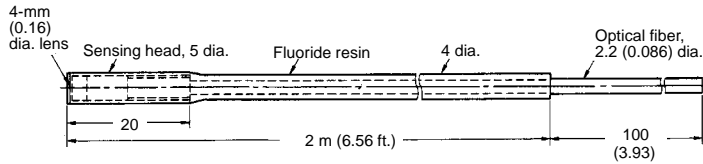

**E32-T22S**

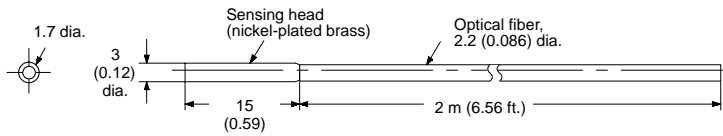

**E32-T24S**

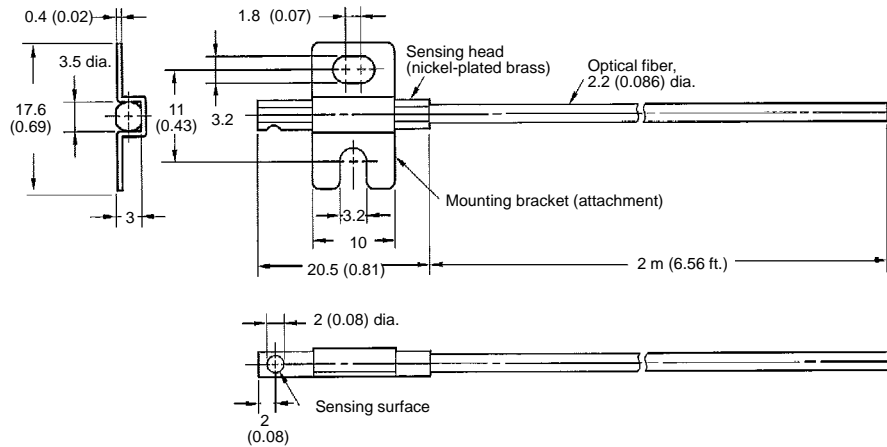

E32-T84S

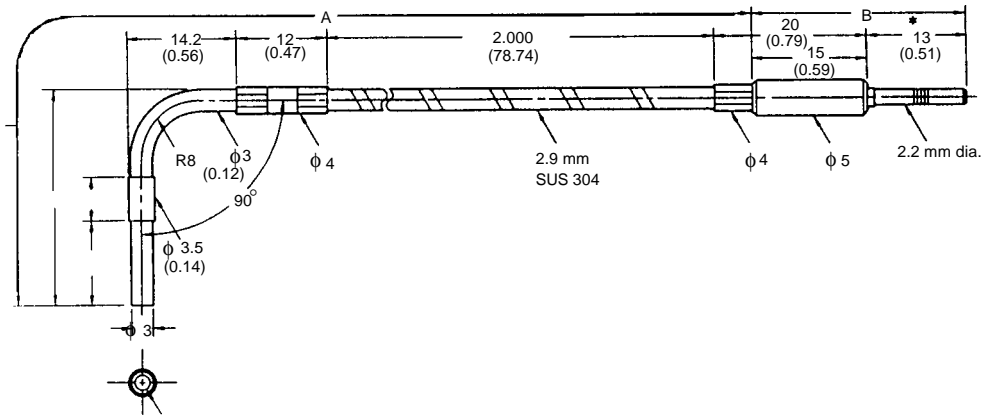

■ DIFFUSE TYPE

General Purpose

E32-CC200

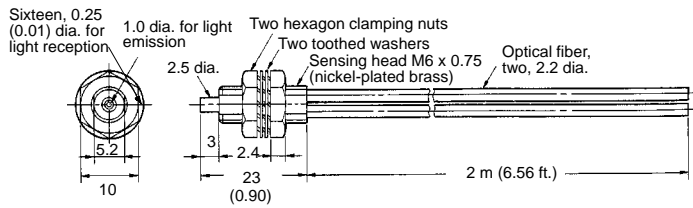

E32-D11

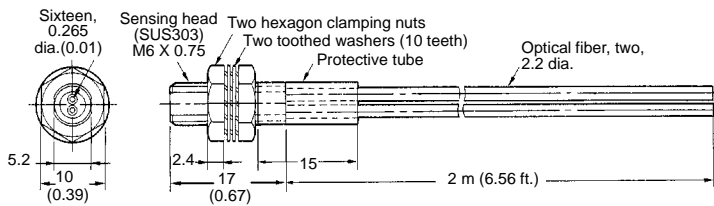

E32-D11L

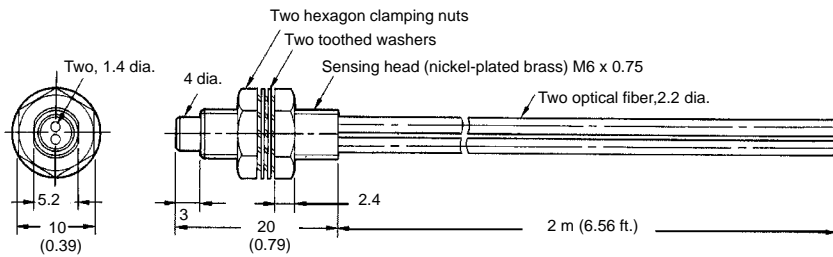

E32-D21

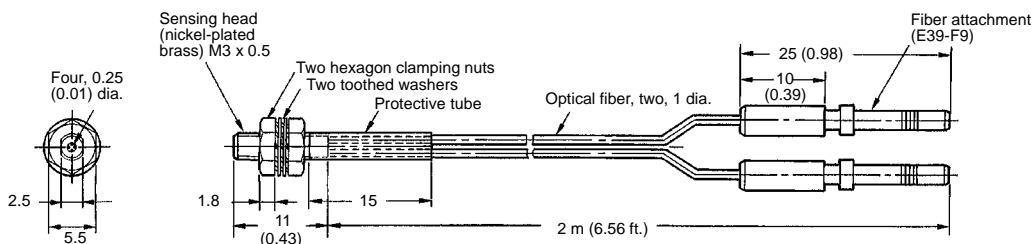

E32-D21L

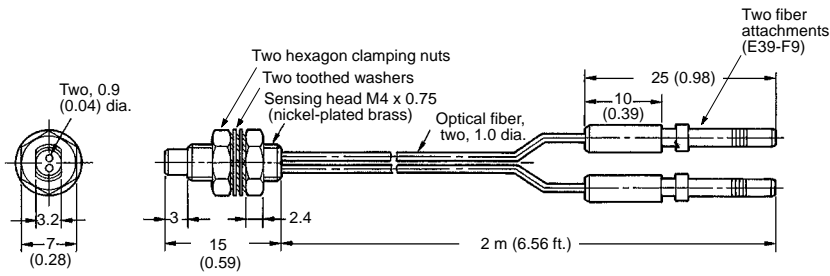

E32-D22L

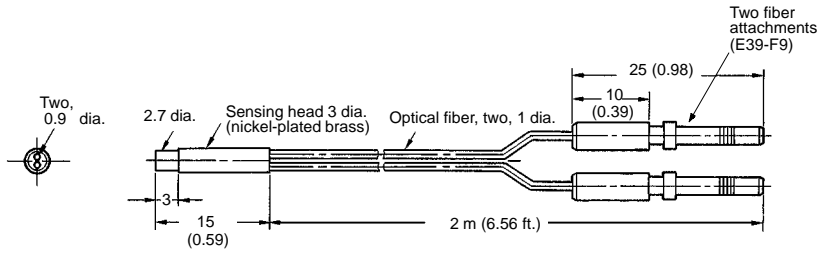

E32-D32

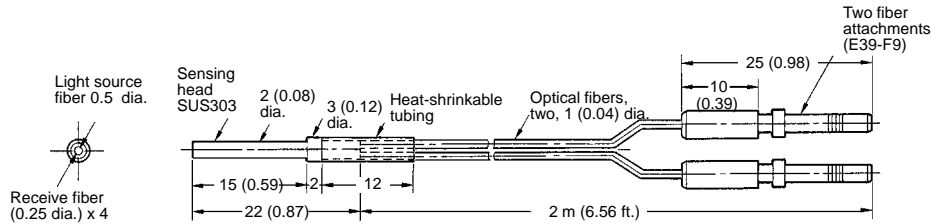

E32-D32L

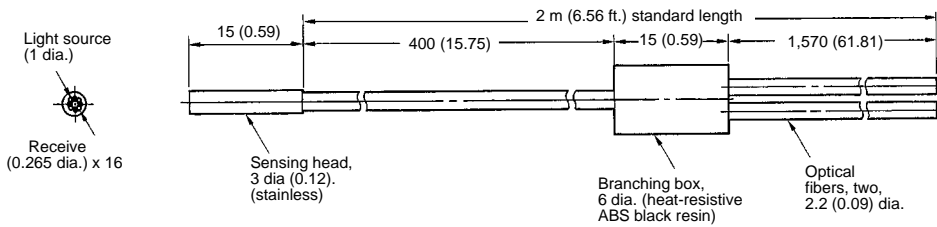

E32-DC50, E32-DC200, E32-DC500, E32-DC1000

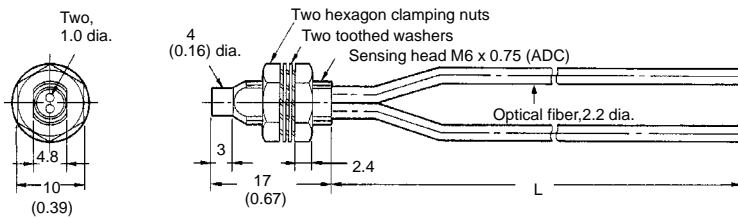

Part number	L
E32-DC50	50 cm (19 in)
E32-DC200	2 m (6.56 ft.)
E32-DC500	5 m (16.3 ft.)
E32-DC1000	10 m (32.8 ft.)

E32-DC200C

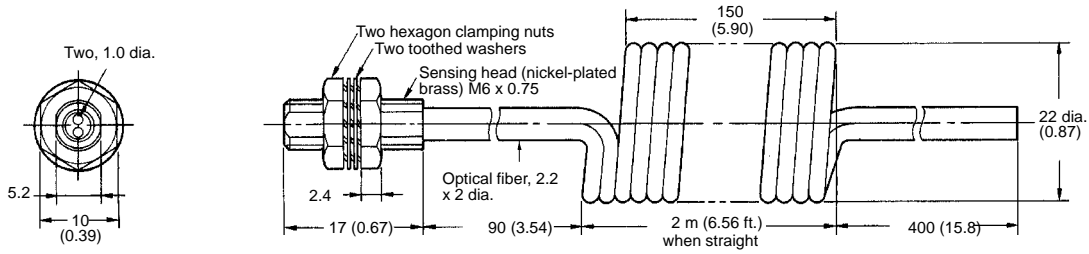

E32-DC200E

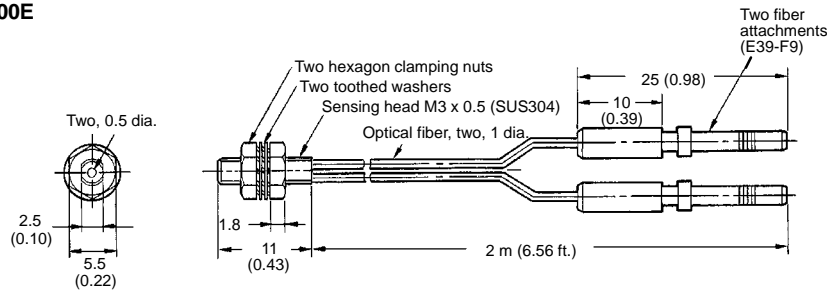

Armored Type

E32-UDAT1-3F  
E32-UDAT1-6F

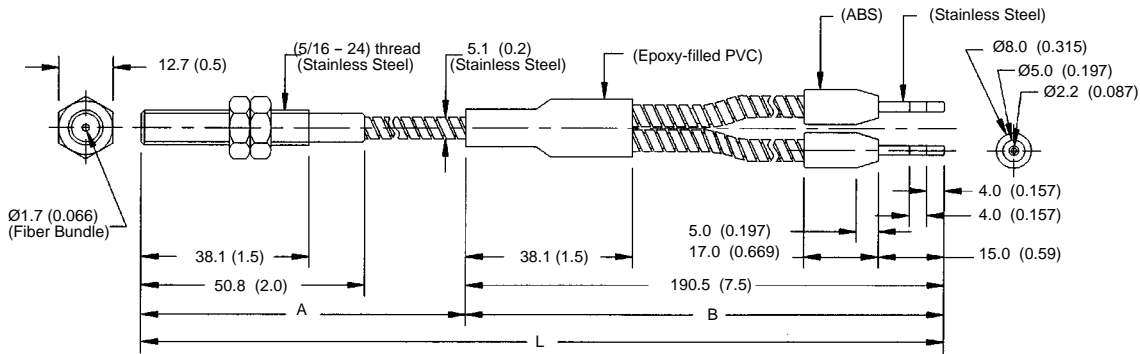

Note: Distance A can withstand 150°C (302°F); Distance B can withstand 70°C (158°F); L=3ft. or 6ft.

E32-UDBT1-3F  
E32-UDBT1-6F

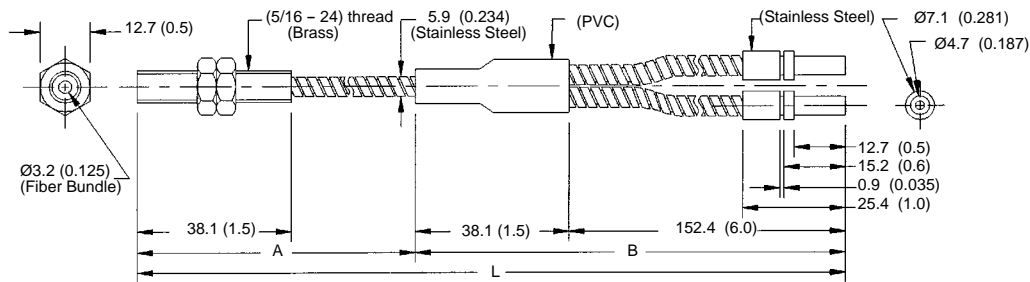

Note: Distance A can withstand 200°C (392°F); Distance B can withstand 70°C (158°F); L=3ft. or 6ft.

Probe Type

E32-DC33

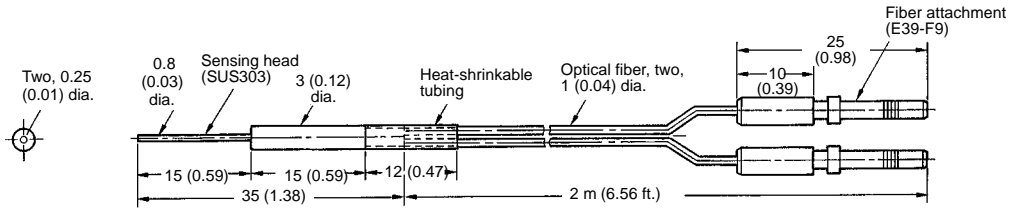

E32-DC200B  
E32-DC200B4

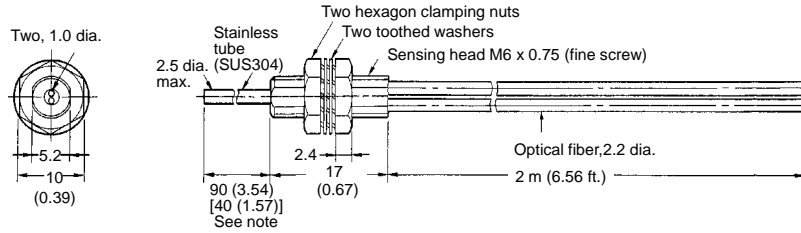

Note: The values in the brackets are for the E32-DC200B4.

E32-DC200D  
E32-DC200D4

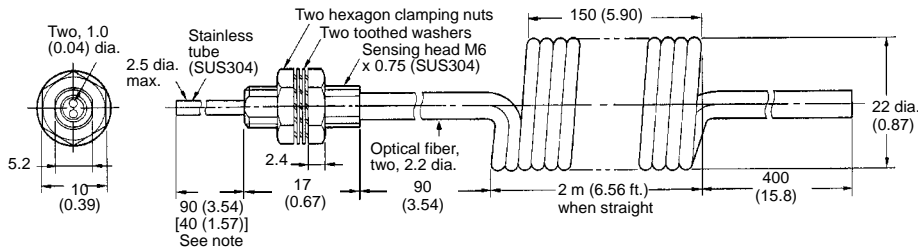

Note: The value in the brackets is for the E32-DC200D4.

E32-DC200F  
E32-DC200F4

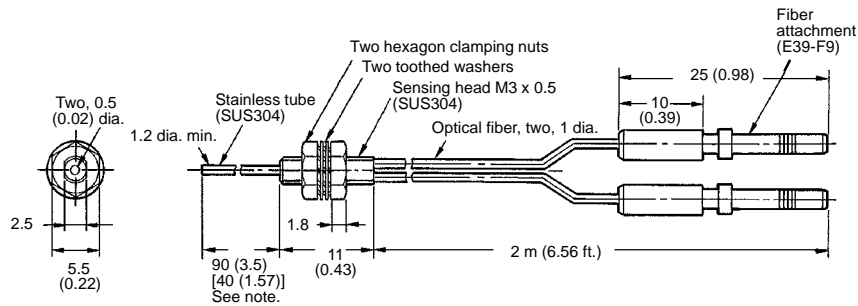

Note: The values in the brackets are for the E32-TC200F4.

**E32-DC9G**  
**E32-DC9G4**

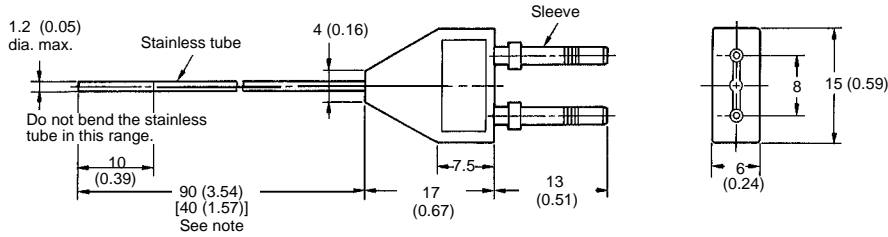

Note: The values in the brackets are for the E32-DC9G4.

**Side Beam Type**

**E32-D14L**

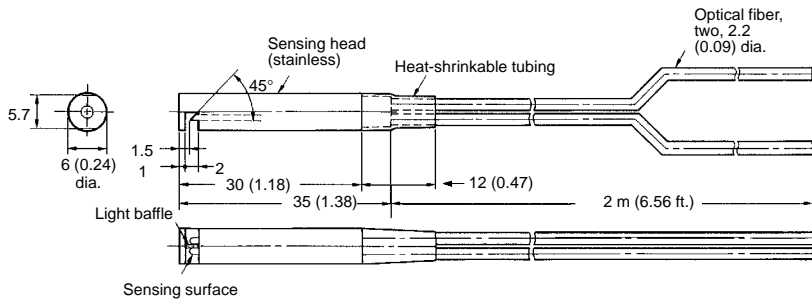

**E32-D24**

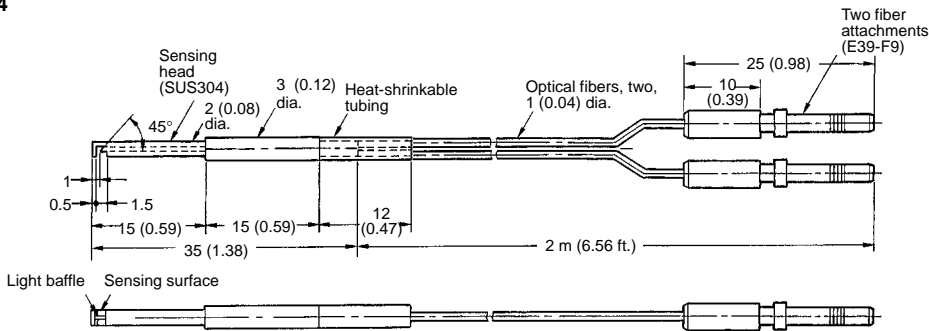

**High Temperature Type**

**E32-D51**

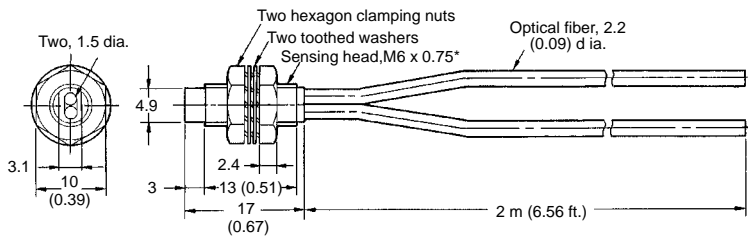

\*nickel-plated brass

Note: Resistant temperature is 150°C (302°F). Resistant temperature is 130°C (266°F) when used continuously.

E32-D61

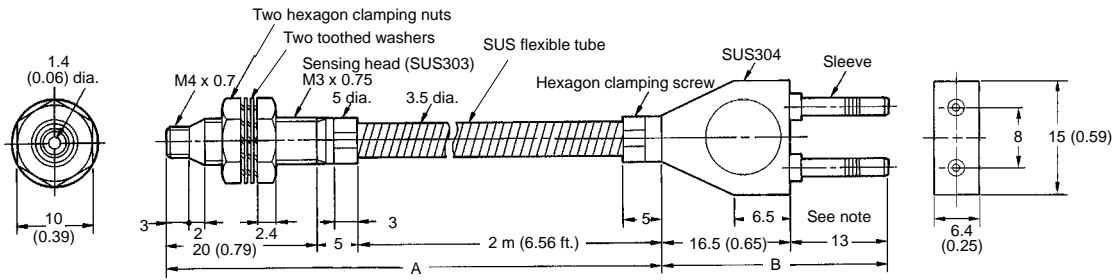

Note: Section A resists 300°C (572°F) and section B (which is inserted to the amplifier) resists 110°C (230°F). The operating temperature of section B must also be within the withstand temperature range of the amplifier.

E32-D73

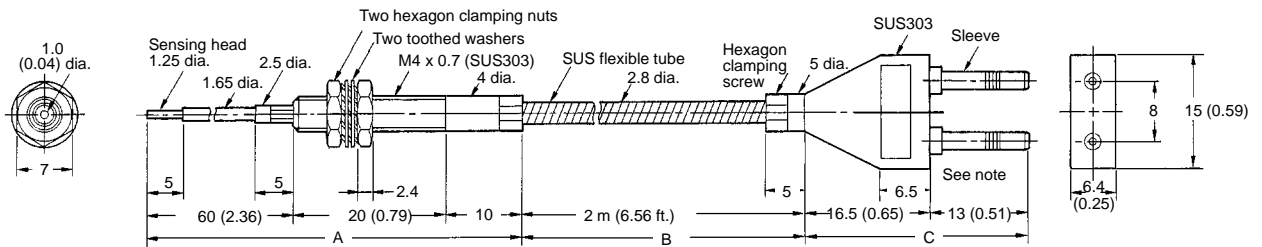

Note: Section A resists 400°C (752°F), section B resists 300°C (572°F) and section C (which is inserted to the amplifier) resists 110°C (230°F). The operating temperature of section C must also be within the withstand temperature range of the amplifier.

Convergent Type and Special Purpose

E32-D12F

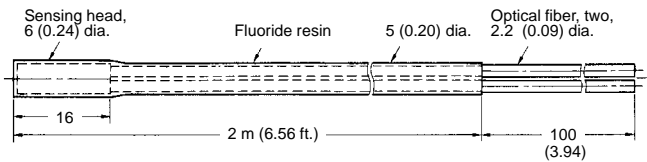

E32-L24L

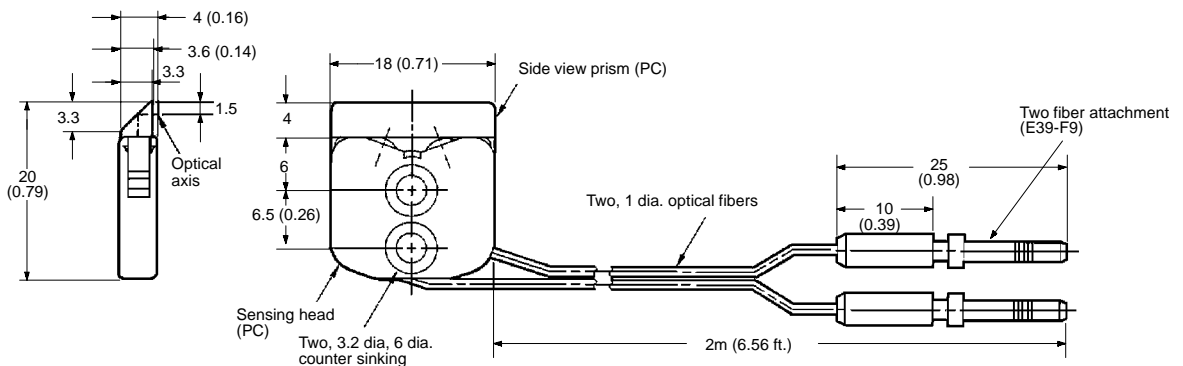

E32-L25

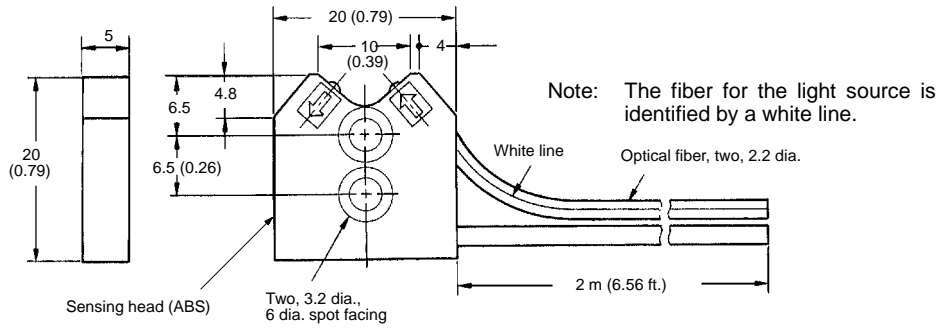

E32-L25A

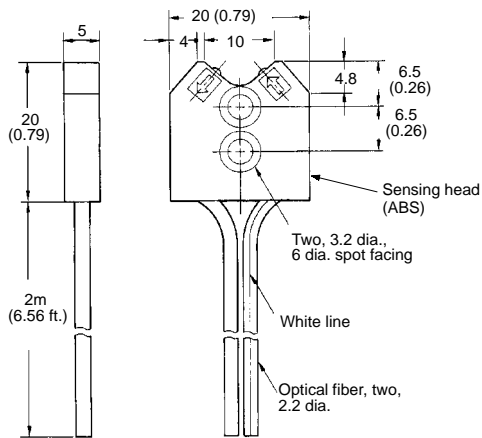

E32-L25L

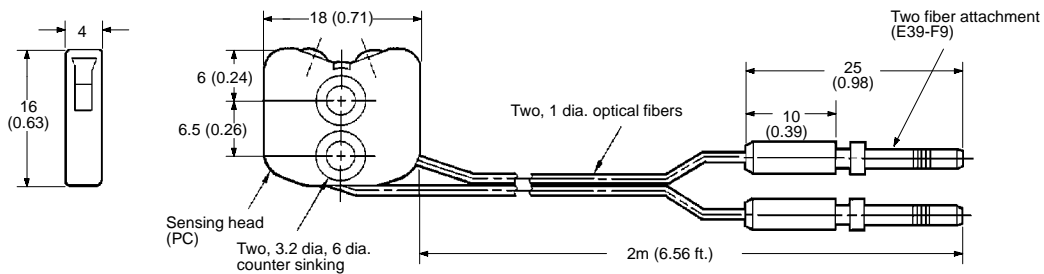



■ RETROREFLECTIVE TYPE

Special Purpose

E32-R16

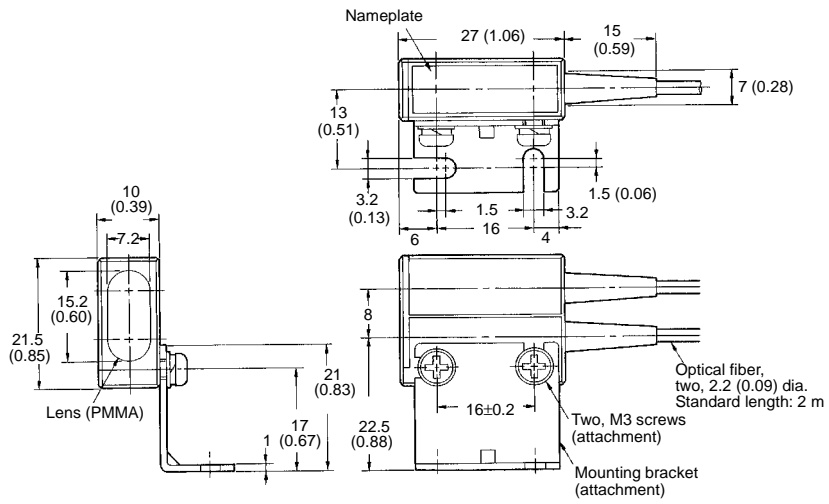

E32-R21

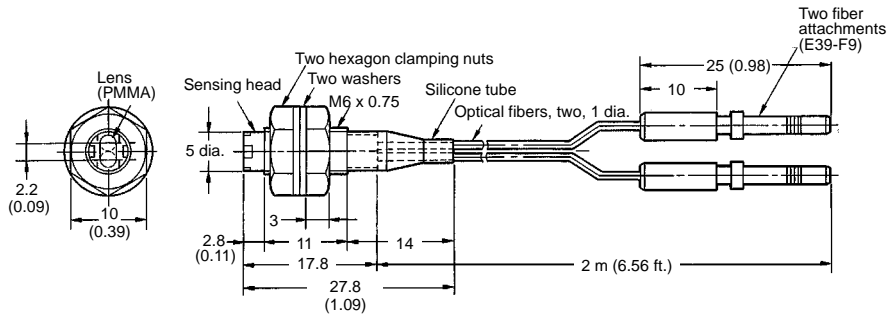

# Installation

## ■ CUTTING FIBER

Insert a fiber into the Fiber Cutter and determine the length of the fiber to be cut.

Press down the Fiber Cutter in a single stroke to cut the fiber.

When the fiber is cut, an insertion mark is inscribed on the fiber.

For a 2.2-mm dia. standard fiber only.

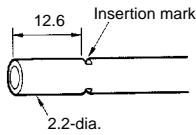

Insert a fiber into the Fiber Cutter in the direction indicated by the arrow (refer to the following figure).

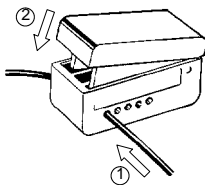

The cutting holes cannot be used twice. If the same hole is used twice, the cutting face of the fiber will be rough and the sensing distance will be reduced. Always use an unused hole.

Use either one of the two holes on the right (refer to the following figure) to cut a thin fiber as follows:

1. An attachment is temporarily fitted to a thin fiber before shipment.

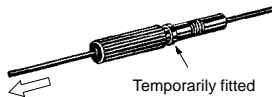

2. Secure the attachment after adjusting the position of it in the direction indicated by the arrow.
3. Insert the fiber into the E39-F4 to cut.

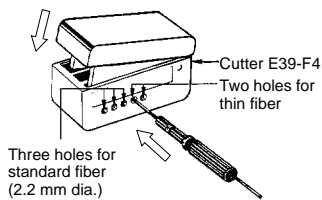

Note: Insert the fiber in the direction indicated by the arrow.

## ■ BENDING RADIUS

### E39-F11 Sleeve Bender

The bending radius of the stainless tube should be as large as possible. The smaller the bending radius becomes, the shorter the sensing distance will be.

Insert the tip of the stainless sleeve to the Sleeve Bender and bend the stainless sleeve slowly along the curve of the Sleeve Bender (refer to the figure).

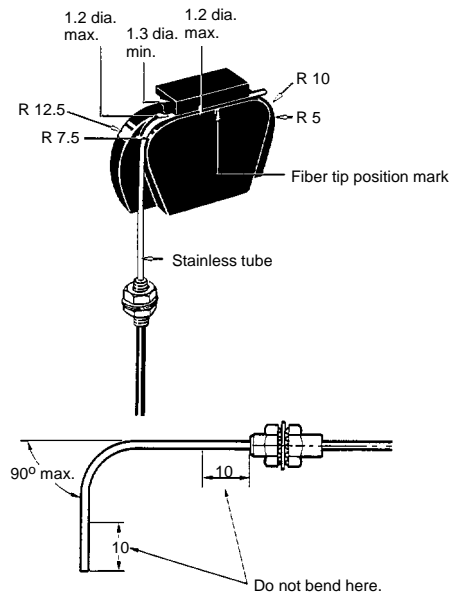

## ■ FIBER UNITS WITH 90° BEND IN STAINLESS STEEL TUBE

### Applicable Models

E32-TC200B/TC200F/DC200F

### Appearance

#### Stainless Steel Tube with a 90° Bend at the Tip

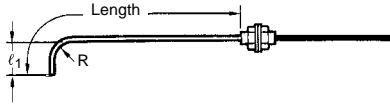

Bending radius	$l_1 (+1)$	
R 5.0	10.0 mm	15.0 mm
R 7.5	12.5 mm	17.5 mm
R 10.0	15.0 mm	20.0 mm
R 12.5	17.5 mm	22.5 mm

The length overall is 120 mm max.

Note: If larger  $l_1$  is required, use the E39-F11 Sleeve Bender.

#### Stainless Steel Tube with a 90° Bend at the Base

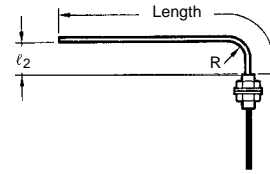

Bending radius	$l_2 (+1)$	
R 5.0	5.0 mm	10.0 mm
R 7.5	7.5 mm	17.5 mm
R 10.0	10.0 mm	20.0 mm
R 12.5	12.5 mm	22.5 mm

The length overall is 120 mm max.

Note: If larger  $l_2$  is required, use the E39-F11 Sleeve Bender.

### Sensing Distance for Tubes with 90° Bends

Part Number	Amplifier	Bending Radius				
		Standard	R5.0	R7.5	R10.0	R12.5
E32-TC200B	E3X-H11	400 mm	260 mm	330 mm	360 mm	400 mm
	E3X-A□□	180 mm	110 mm	140 mm	160 mm	180 mm
E32-TC200F	E3X-H11	100 mm	55 mm	100 mm	100 mm	100 mm
	E3X-A□□	50 mm	30 mm	50 mm	50 mm	50 mm
E32-DC200F	E3X-H11	36 mm	30 mm	36 mm	36 mm	36 mm
	E3X-A□□	18 mm	10 mm	18 mm	18 mm	18 mm

## ■ FIBER UNIT WITH LONGER FIBER

### Applicable Models

E32-TC200/-DC200  
E32-TC200B/-DC200B  
E32-TC200E/-DC200E  
E32-TC200F/-DC200F  
E32-TC200A

### Appearance

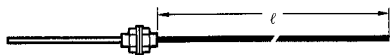

The length can be ordered in increments of 1 m between 6 m min. and 20 m max.. (2-m and 5-m fiber length types are standard for E32-TC200, E32-DC200.)

## ■ HANDLING

### E32-D51/-T51 Heat-resisting Fiber

The bending radius of the fibers should be 35 mm min.

Connecting fibers via the E39-F10 Fiber Connector is not possible.

The withstand temperature of the Heat-Resisting Fibers is 150°C max. In continuous operation, the ambient temperature should be 130°C max.

### E32-T14/-T51

If the sensor is ON because some object in front of the lenses reflects light, attach the black seals (sold together) to the lenses.

### E32-T14/-G14

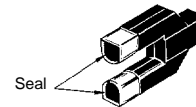

### E32-L25 (A) Wafer Sensor

Insert the fiber with a white line into the light projection side of the Amplifier.

The tightening force of the sensor head is 8 kgf • cm (0.75 N • m).

Avoid places where water could be sprayed onto the E32-L25(A).

### E32-T16 Slit Seal (Attachment)

Peel the E32-T16 Slit Seal off the ground paper and affix the Slit Seal to the sensing face of the sensor so that the corners of the Slit Seal fit in with the corners of the sensing face. To sense an object at a distance of 30 cm max., a 0.5-mm wide Slit Seal must be used.

### E32-T16 Sensing Head

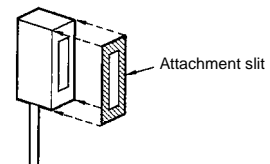

## ■ ATTACHMENT UNITS

### Applications

#### E39-F10 Fiber Connector

Use the following procedure (refer to the figure) to connect fibers via the Fiber Connector.

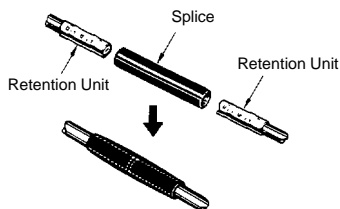

Each fiber should be as close as possible before they are connected.

Sensing distance will be reduced by approximately 25% when fibers are connected.

Only fibers with 2.2 mm dia. can be connected.

#### Protective Spiral Tube

Insert a fiber into the Protective Spiral Tube from the head connector side (screwed) of the tube.

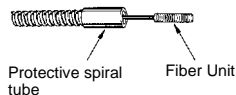

Push the fiber into the Protective Spiral Tube. The tube should be straight so that the fiber is not twisted when inserted. Then turn the end cap of the spiral tube.

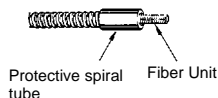

Secure the Protective Spiral Tube on a suitable place with the attached nut.

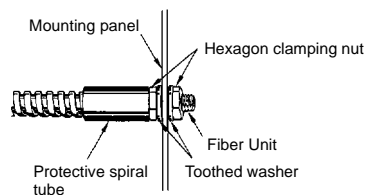

Use the attached saddle to secure the end cap of the Protective Spiral Tube. To secure the Protective Spiral Tube at a position other than the end cap, apply tape to the tube so that the portion becomes thicker in diameter.

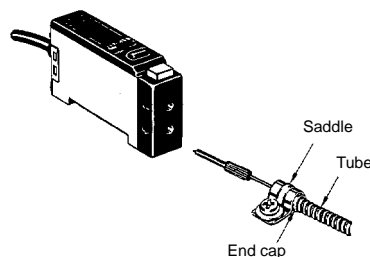

#### E39-F3A Reflective Unit Lens

When the E39-F3A is attached to the fiber, the E3X can sense the light reflected from the interior of the E39-F3A. If this happens, adjust the sensitivity of the E3X Amplifier with Sensitivity Adjustor.

Place a sensing object or white paper at the sensing distance set and adjust the insertion length of the Fiber Unit to the E39-F3A so that the light spot is as small as possible. Then fix the position of the Fiber Unit with the hexagonal wrench (attachment)

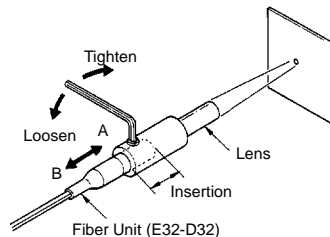

A: The focus is farther than the E39-F3A.  
B: The focus is closer than the E39-F3A

**NOTE: DIMENSIONS SHOWN ARE IN MILLIMETERS. To convert millimeters to inches divide by 25.4.**

# OMRON®

Omron Europe B.V. EMA-ISD, tel:+31 23 5681390, fax:+31 23 5681397, <http://www.eu.omron.com/ema>