

LDO Regulator - Very Low Dropout, CMOS, Bias Rail 700 mA

NCP136

The NCP136 is a 700 mA VLDO equipped with NMOS pass transistor and a separate bias supply voltage (V_{BIAS}). The device provides very stable, accurate output voltage with low noise suitable for space constrained, noise sensitive applications. In order to optimize performance for battery operated portable applications, the NCP136 features low I_Q consumption. The WLCSP6 1.4 mm x 0.8 mm Chip Scale package is optimized for use in space constrained applications.

Features

- Input Voltage Range: V_{OUT} to 5.5 V
- Bias Voltage Range: 2.5 V to 5.5 V
- Fixed Voltage Version Available
- Output Voltage Range: 0.4 V to 1.8 V (Fixed)
- $\pm 1\%$ Accuracy over Temperature, $0.5\% V_{OUT}$ @ 25°C
- Ultra-Low Dropout: Typ. 40 mV at 700 mA
- Very Low Bias Input Current of Typ. $80 \mu\text{A}$
- Very Low Bias Input Current in Disable Mode: Typ. $0.5 \mu\text{A}$
- Logic Level Enable Input for ON/OFF Control
- Output Active Discharge Option Available
- Stable with a $10 \mu\text{F}$ Ceramic Capacitor
- Available in WLCSP6 – 1.4 mm x 0.8 mm, 0.4 mm pitch Package
- These Devices are Pb-Free, Halogen Free/BFR Free and are RoHS Compliant

Typical Applications

- Battery-powered Equipment
- Smartphones, Tablets
- Cameras, DVRs, STB and Camcorders

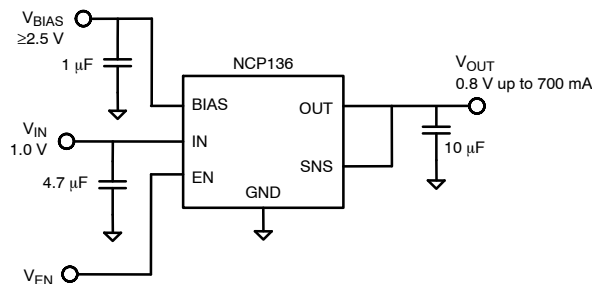

Figure 1. Typical Application Schematic



ON Semiconductor®

www.onsemi.com



WLCSP6, 1.4x0.8x0.33
CASE 567XK



WLCSP6, 1.4x0.8x0.37
CASE 567YU

MARKING DIAGRAM



XX = Specific Device Code
M = Month Code
▪ = Pb-Free Package

PIN CONNECTIONS

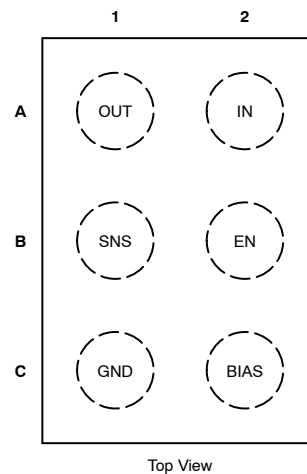

ORDERING INFORMATION

See detailed ordering, marking and shipping information on page 11 of this data sheet.

NCP136

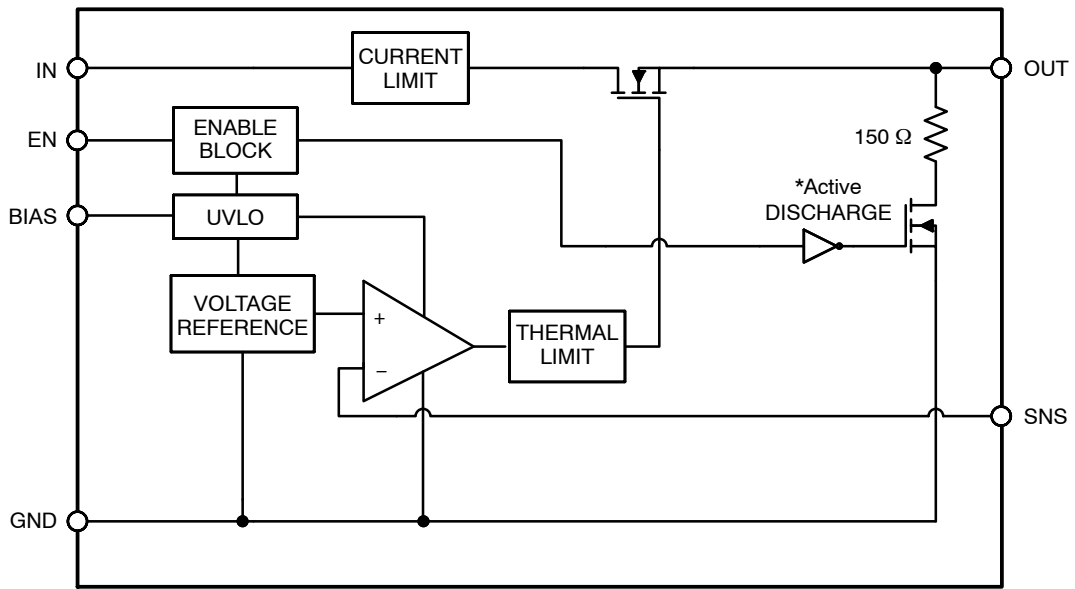

*Active output discharge function is present only in NCP136A and NCP136C option devices.

Figure 2. Simplified Schematic Block Diagram – Fixed Version

NCP136

PIN FUNCTION DESCRIPTION

Pin No. WLCSP6	Pin Name	Description
A1	OUT	Regulated Output Voltage pin
A2	IN	Input Voltage Supply pin
B1	SNS	Output voltage Sensing Input. Connect to Output on the PCB to output the voltage corresponding to the part version.
B2	EN	Enable pin. Driving this pin high enables the regulator. Driving this pin low puts the regulator into shutdown mode.
C1	GND	Ground pin
C2	BIAS	Bias voltage supply for internal control circuits. This pin is monitored by internal Under-Voltage Lockout Circuit.

ABSOLUTE MAXIMUM RATINGS

Rating	Symbol	Value	Unit
Input Voltage (Note 1)	V_{IN}	-0.3 to 6	V
Output Voltage	V_{OUT}	-0.3 to $(V_{IN}+0.3) \leq 6$	V
Chip Enable, Bias and SNS Input	$V_{EN}, V_{BIAS}, V_{SNS}$	-0.3 to 6	V
Output Short Circuit Duration	t_{SC}	unlimited	s
Maximum Junction Temperature	T_J	150	°C
Storage Temperature	T_{STG}	-55 to 150	°C
ESD Capability, Human Body Model (Note 2)	ESD_{HBM}	2000	V
ESD Capability, Machine Model (Note 2)	ESD_{MM}	200	V

Stresses exceeding those listed in the Maximum Ratings table may damage the device. If any of these limits are exceeded, device functionality should not be assumed, damage may occur and reliability may be affected.

1. Refer to ELECTRICAL CHARACTERISTICS and APPLICATION INFORMATION for Safe Operating Area.
2. This device series incorporates ESD protection (except OUT pin) and is tested by the following methods:
 ESD Human Body Model tested per EIA/JESD22-A114
 ESD Machine Model tested per EIA/JESD22-A115
 Latchup Current Maximum Rating tested per JEDEC standard: JESD78.

THERMAL CHARACTERISTICS

Rating	Symbol	Value	Unit
Thermal Characteristics, WLCSP6 1.4 mm x 0.8 mm Thermal Resistance, Junction-to-Air (Note 3)	$R_{\theta JA}$	69	°C/W

3. This junction-to-ambient thermal resistance under natural convection was derived by thermal simulations based on the JEDEC JESD51 series standards methodology. Only a single device mounted at the center of a high_K (2s2p) 80 mm x 80 mm multilayer board with 1-ounce internal planes and 2-ounce copper on top and bottom. Top copper layer has a dedicated 1.6 sqmm copper area.

NCP136

ELECTRICAL CHARACTERISTICS $-40^{\circ}\text{C} \leq T_J \leq 85^{\circ}\text{C}$; $V_{\text{BIAS}} = 2.7\text{ V}$ or $(V_{\text{OUT}} + 1.6\text{ V})$, whichever is greater, $V_{\text{IN}} = V_{\text{OUT(NOM)}} + 0.3\text{ V}$, $I_{\text{OUT}} = 1\text{ mA}$, $V_{\text{EN}} = 1\text{ V}$, $C_{\text{IN}} = 4.7\text{ }\mu\text{F}$, $C_{\text{OUT}} = 10\text{ }\mu\text{F}$, $C_{\text{BIAS}} = 1\text{ }\mu\text{F}$, unless otherwise noted. Typical values are at $T_J = +25^{\circ}\text{C}$. Min/Max values are for $-40^{\circ}\text{C} \leq T_J \leq 85^{\circ}\text{C}$ unless otherwise noted. (Note 4)

Parameter	Test Conditions	Symbol	Min	Typ	Max	Unit
Operating Input Voltage Range		V_{IN}	$V_{\text{OUT}} + V_{\text{DO}}$		5.5	V
Operating Bias Voltage Range		V_{BIAS}	$(V_{\text{OUT}} + 1.50) \geq 2.5$		5.5	V
Undervoltage Lock-out	V_{BIAS} Rising Hysteresis	UVLO		1.6 0.2		V
Output Voltage Accuracy		V_{OUT}		± 0.5		%
Output Voltage Accuracy	$-40^{\circ}\text{C} \leq T_J \leq 85^{\circ}\text{C}$, $V_{\text{OUT(NOM)}} + 0.1\text{ V} \leq V_{\text{IN}} \leq V_{\text{OUT(NOM)}} + 1.0\text{ V}$, 2.7 V or $(V_{\text{OUT(NOM)}} + 1.6\text{ V})$, whichever is greater < $V_{\text{BIAS}} < 5.5\text{ V}$, $1\text{ mA} < I_{\text{OUT}} < 700\text{ mA}$	V_{OUT}	-1.0		+1.0	%
V_{IN} Line Regulation	$V_{\text{OUT(NOM)}} + 0.1\text{ V} \leq V_{\text{IN}} \leq 5.0\text{ V}$	LineReg		0.01		%/V
V_{BIAS} Line Regulation	2.7 V or $(V_{\text{OUT(NOM)}} + 1.6\text{ V})$, whichever is greater < $V_{\text{BIAS}} < 5.5\text{ V}$	LineReg		0.01		%/V
Load Regulation	$I_{\text{OUT}} = 1\text{ mA}$ to 700 mA	LoadReg		1.5		mV
V_{IN} Dropout Voltage	$I_{\text{OUT}} = 700\text{ mA}$ (Note 5)	V_{DO}		40	60	mV
V_{BIAS} Dropout Voltage	$I_{\text{OUT}} = 700\text{ mA}$, $V_{\text{IN}} = V_{\text{BIAS}}$ (Notes 5, 6)	V_{DO}		1.1	1.5	V
Output Current Limit	$V_{\text{OUT}} = 90\% V_{\text{OUT(NOM)}}$	I_{CL}	800	1450	2000	mA
SNS Pin Operating Current		I_{SNS}		0.1	0.5	μA
Bias Pin Quiescent Current	$V_{\text{BIAS}} = 2.7\text{ V}$, $I_{\text{OUT}} = 0\text{ mA}$	I_{BIASQ}		70	110	μA
Bias Pin Disable Current	$V_{\text{EN}} \leq 0.4\text{ V}$	$I_{\text{BIAS(DIS)}}$		0.5	1	μA
Input Pin Disable Current	$V_{\text{EN}} \leq 0.4\text{ V}$	$I_{\text{VIN(DIS)}}$		0.5	1	μA
EN Pin Threshold Voltage	EN Input Voltage "H"	$V_{\text{EN(H)}}$	0.9			V
	EN Input Voltage "L"	$V_{\text{EN(L)}}$			0.4	
EN Pull Down Current	$V_{\text{EN}} = 5.5\text{ V}$	I_{EN}		0.3	1	μA
Power Supply Rejection Ratio	V_{IN} to V_{OUT} , $f = 1\text{ kHz}$, $I_{\text{OUT}} = 10\text{ mA}$, $V_{\text{IN}} \geq V_{\text{OUT}} + 0.5\text{ V}$, $V_{\text{OUT(NOM)}} = 1.2\text{ V}$, $V_{\text{BIAS}} = 3.0\text{ V}$	PSRR(V_{IN})		75		dB
	V_{BIAS} to V_{OUT} , $f = 1\text{ kHz}$, $I_{\text{OUT}} = 10\text{ mA}$, $V_{\text{IN}} \geq V_{\text{OUT}} + 0.5\text{ V}$, $V_{\text{OUT(NOM)}} = 1.2\text{ V}$, $V_{\text{BIAS}} = 3.0\text{ V}$	PSRR(V_{BIAS})		80		
Output Noise Voltage	$V_{\text{IN}} = V_{\text{OUT}} + 0.5\text{ V}$, $f = 10\text{ Hz}$ to 100 kHz , $V_{\text{OUT(NOM)}} = 1.2\text{ V}$	V_{N}		40		μV_{RMS}
Thermal Shutdown Threshold	Temperature increasing			160		$^{\circ}\text{C}$
	Temperature decreasing			140		
Output Discharge Pull-Down	$V_{\text{EN}} \leq 0.4\text{ V}$, $V_{\text{OUT}} = 0.5\text{ V}$, NCP136A and NCP136C option	R_{DISCH}		150		Ω

Product parametric performance is indicated in the Electrical Characteristics for the listed test conditions, unless otherwise noted. Product performance may not be indicated by the Electrical Characteristics if operated under different conditions.

4. Performance guaranteed over the indicated operating temperature range by design and/or characterization. Production tested at $T_A = 25^{\circ}\text{C}$. Low duty cycle pulse techniques are used during the testing to maintain the junction temperature as close to ambient as possible.
5. Dropout voltage is characterized when V_{OUT} falls 3% below $V_{\text{OUT(NOM)}}$.
6. For fixed output voltages below 1.5 V, V_{BIAS} dropout does not apply due to a minimum Bias operating voltage of 2.5 V.

NCP136

ELECTRICAL CHARACTERISTICS $-40^{\circ}\text{C} \leq T_J \leq 85^{\circ}\text{C}$; $I_{\text{OUT}} = 1 \text{ mA}$, $V_{\text{EN}} = 1 \text{ V}$, $C_{\text{IN}} = 4.7 \mu\text{F}$, $C_{\text{OUT}} = 10 \mu\text{F}$, $C_{\text{BIAS}} = 1 \mu\text{F}$. Typical values are at $T_J = +25^{\circ}\text{C}$. Min/Max values are for $-40^{\circ}\text{C} \leq T_J \leq 85^{\circ}\text{C}$ unless otherwise noted. (Note 7)

Parameter	Test conditions	Symbol	Min	Typ	Max	Unit
-----------	-----------------	--------	-----	-----	-----	------

NCP136xFCRC040T2G $V_{\text{BIAS}} = 3 \text{ V}$, $V_{\text{IN}} = 0.6 \text{ V}$

Delay time	From assertion of V_{EN} to output voltage increase	'A' option	t_{DELAY}		73	μs
Rise time	V_{OUT} rise from 10% to 90% $V_{\text{OUT(NOM)}}$	'A' option	t_{RISE}		15	
Turn-On Time	From assertion of V_{EN} to $V_{\text{OUT}} = 98\% V_{\text{OUT(NOM)}}$	'A' option	t_{ON}		98	

NCP136xFCT080T2G & NCP136xFCRC080T2G $V_{\text{BIAS}} = 3 \text{ V}$, $V_{\text{IN}} = 1.0 \text{ V}$

Delay time	From assertion of V_{EN} to output voltage increase	'A' and 'B' option	t_{DELAY}		55	μs
Rise time	V_{OUT} rise from 10% to 90% $V_{\text{OUT(NOM)}}$	'A' and 'B' option	t_{RISE}		17	
Turn-On Time	From assertion of V_{EN} to $V_{\text{OUT}} = 98\% V_{\text{OUT(NOM)}}$	'A' and 'B' option	t_{ON}		80	

NCP136xFCT088T2G $V_{\text{BIAS}} = 3 \text{ V}$, $V_{\text{IN}} = 1.1 \text{ V}$

Delay time	From assertion of V_{EN} to output voltage increase	'A' option	t_{DELAY}		71	μs
Rise time	V_{OUT} rise from 10% to 90% $V_{\text{OUT(NOM)}}$	'A' option	t_{RISE}		16	
Turn-On Time	From assertion of V_{EN} to $V_{\text{OUT}} = 98\% V_{\text{OUT(NOM)}}$	'A' option	t_{ON}		97	

NCP136xFCT105T2G $V_{\text{BIAS}} = 3 \text{ V}$, $V_{\text{IN}} = 1.25 \text{ V}$

Delay time	From assertion of V_{EN} to output voltage increase	'A' option	t_{DELAY}		71	μs
Rise time	V_{OUT} rise from 10% to 90% $V_{\text{OUT(NOM)}}$	'A' option	t_{RISE}		18	
Turn-On Time	From assertion of V_{EN} to $V_{\text{OUT}} = 98\% V_{\text{OUT(NOM)}}$	'A' option	t_{ON}		102	

NCP136xFCT110T2G $V_{\text{BIAS}} = 3 \text{ V}$, $V_{\text{IN}} = 1.3 \text{ V}$

Delay time	From assertion of V_{EN} to output voltage increase	'A' option	t_{DELAY}		71	μs
Rise time	V_{OUT} rise from 10% to 90% $V_{\text{OUT(NOM)}}$	'A' option	t_{RISE}		19	
Turn-On Time	From assertion of V_{EN} to $V_{\text{OUT}} = 98\% V_{\text{OUT(NOM)}}$	'A' option	t_{ON}		105	

NCP136xFCT120T2G $V_{\text{BIAS}} = 3 \text{ V}$, $V_{\text{IN}} = 1.4 \text{ V}$

Delay time	From assertion of V_{EN} to output voltage increase	'A' option	t_{ON}		70	μs
		'C' option			80	
Rise time	V_{OUT} rise from 10% to 90% $V_{\text{OUT(NOM)}}$	'A' option	t_{RISE}		21	
		'C' option			80	
Turn-On Time	From assertion of V_{EN} to $V_{\text{OUT}} = 98\% V_{\text{OUT(NOM)}}$	'A' option	t_{ON}		108	
		'C' option			210	

Product parametric performance is indicated in the Electrical Characteristics for the listed test conditions, unless otherwise noted. Product performance may not be indicated by the Electrical Characteristics if operated under different conditions.

7. Performance guaranteed over the indicated operating temperature range by design and/or characterization. Production tested at $T_A = 25^{\circ}\text{C}$. Low duty cycle pulse techniques are used during the testing to maintain the junction temperature as close to ambient as possible.

TYPICAL CHARACTERISTICS

At $T_J = +25^\circ\text{C}$, $V_{IN} = V_{OUT(NOM)} + 0.3\text{ V}$, $V_{BIAS} = 2.8\text{ V}$, $V_{EN} = V_{BIAS}$, $V_{OUT(NOM)} = 1.2\text{ V}$, $I_{OUT} = 700\text{ mA}$, $C_{IN} = 4.7\text{ }\mu\text{F}$, $C_{BIAS} = 1\text{ }\mu\text{F}$, and $C_{OUT} = 10\text{ }\mu\text{F}$ (effective capacitance), unless otherwise noted.

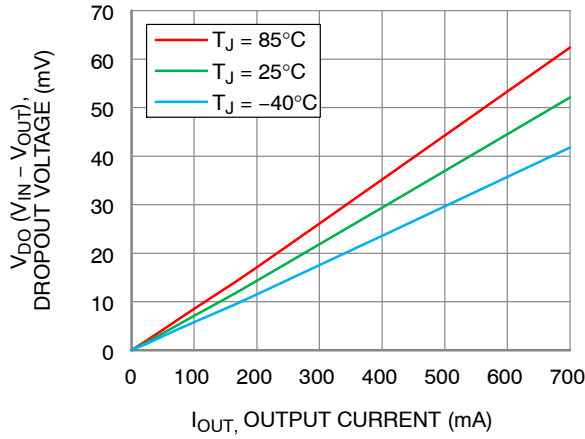

Figure 3. V_{IN} Dropout Voltage vs. I_{OUT} and T_J

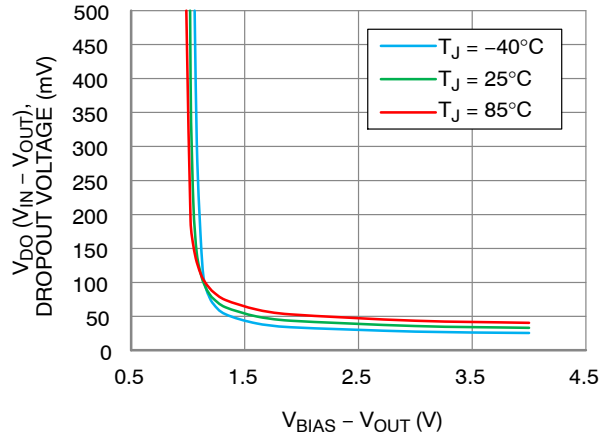

Figure 4. V_{IN} Dropout Voltage vs. $V_{BIAS} - V_{OUT}$ and T_J

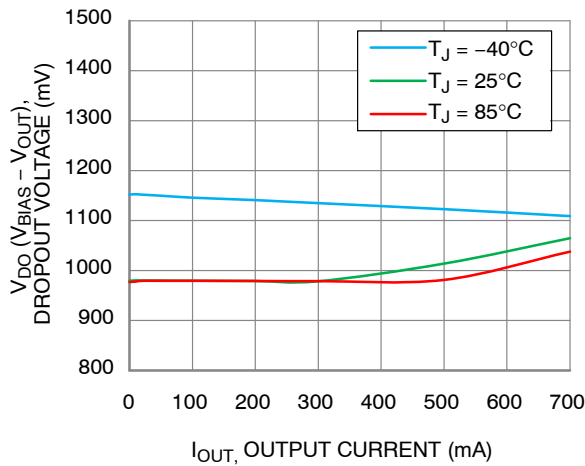

Figure 5. V_{BIAS} Dropout Voltage vs. I_{OUT} and T_J

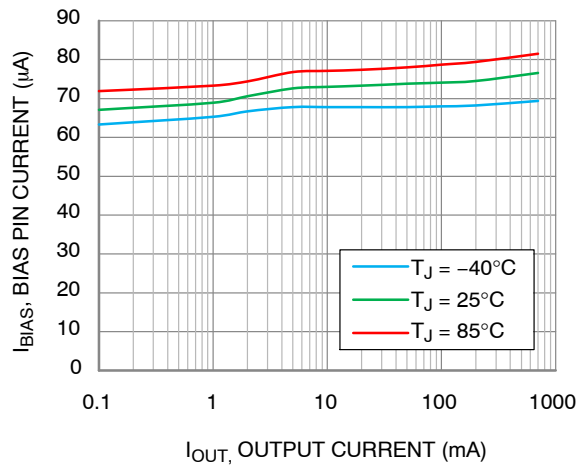

Figure 6. BIAS Pin Current vs. I_{OUT} and T_J

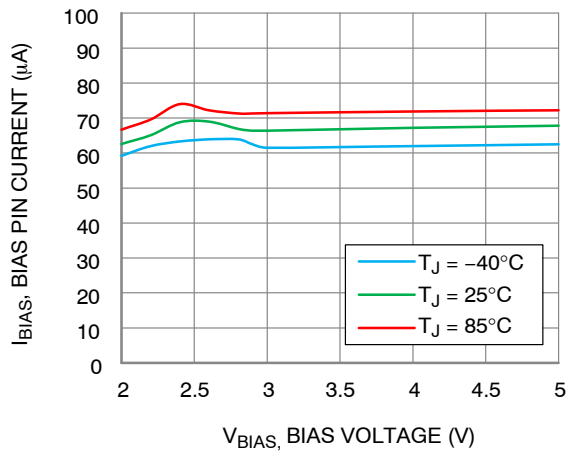

Figure 7. BIAS Pin Current vs. V_{BIAS} and T_J

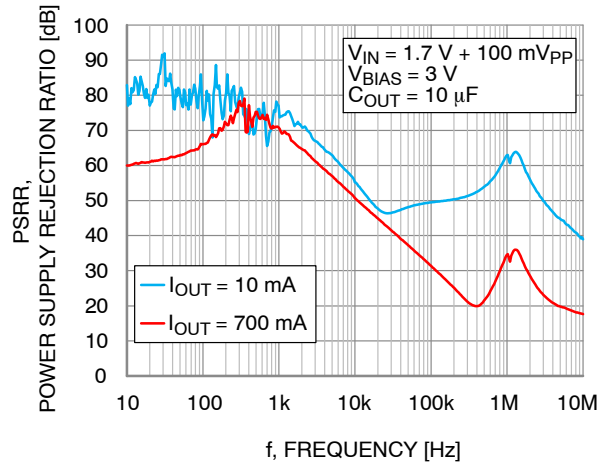

Figure 8. V_{IN} PSRR vs. Frequency

TYPICAL CHARACTERISTICS (continued)

At $T_J = +25^\circ\text{C}$, $V_{IN} = V_{OUT(NOM)} + 0.3\text{ V}$, $V_{BIAS} = 2.8\text{ V}$, $V_{EN} = V_{BIAS}$, $V_{OUT(NOM)} = 1.2\text{ V}$, $I_{OUT} = 700\text{ mA}$, $C_{IN} = 4.7\text{ }\mu\text{F}$, $C_{BIAS} = 1\text{ }\mu\text{F}$, and $C_{OUT} = 10\text{ }\mu\text{F}$ (effective capacitance), unless otherwise noted.

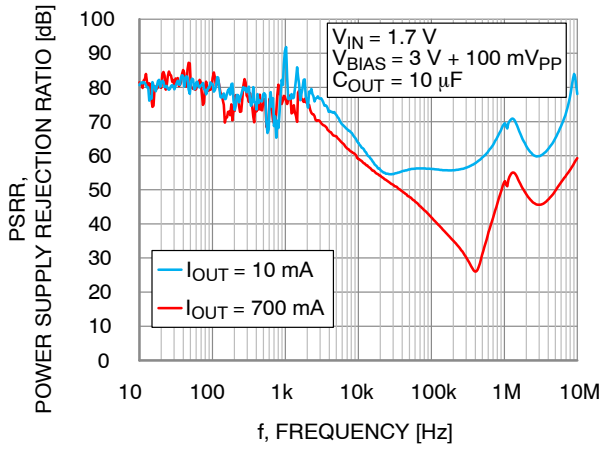

Figure 9. V_{BIAS} PSRR vs. Frequency

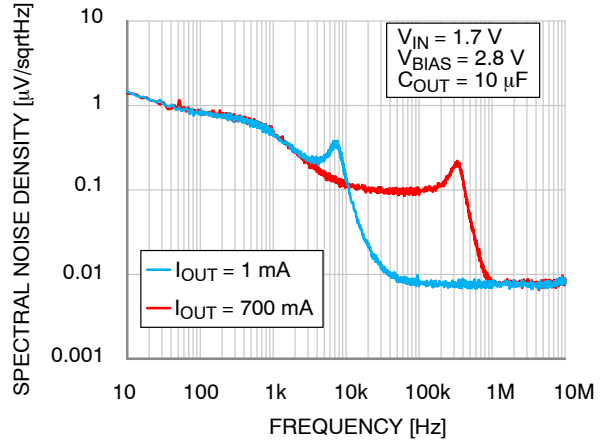

Figure 10. Output Voltage Spectral Noise Density vs. Frequency

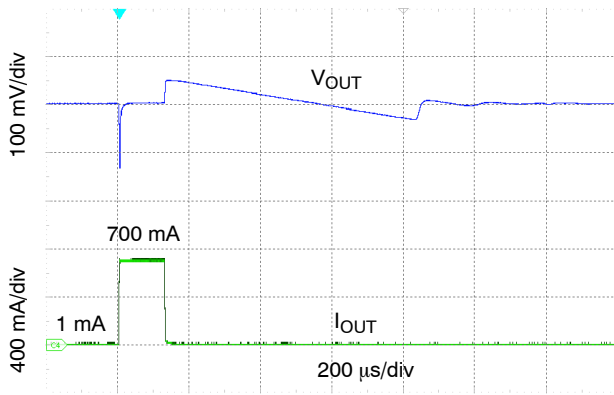

Figure 11. Load Transient Response, $I_{OUT} = 1\text{ mA}$ to 700 mA in $1\text{ }\mu\text{s}$, $C_{OUT} = 10\text{ }\mu\text{F}$

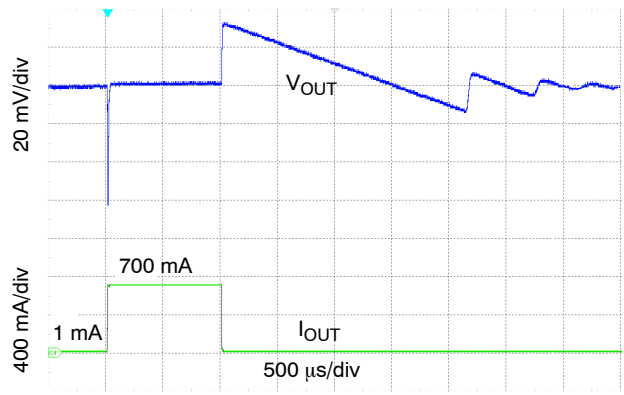

Figure 12. Load Transient Response, $I_{OUT} = 1\text{ mA}$ to 700 mA in $1\text{ }\mu\text{s}$, $C_{OUT} = 47\text{ }\mu\text{F}$

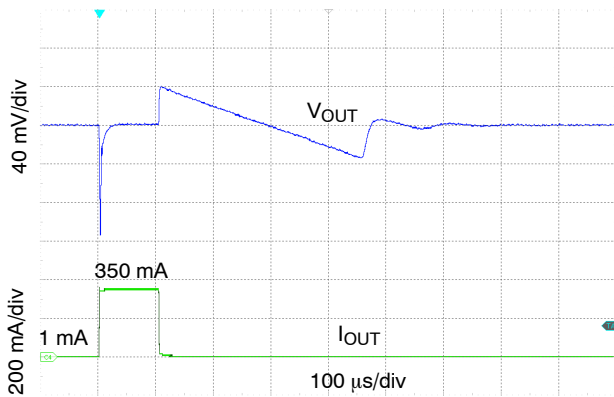

Figure 13. Load Transient Response, $I_{OUT} = 1\text{ mA}$ to 350 mA in $1\text{ }\mu\text{s}$, $C_{OUT} = 4.7\text{ }\mu\text{F}$

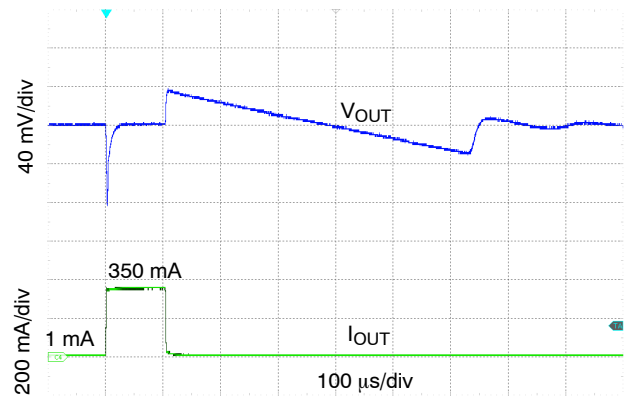

Figure 14. Load Transient Response, $I_{OUT} = 1\text{ mA}$ to 350 mA in $1\text{ }\mu\text{s}$, $C_{OUT} = 10\text{ }\mu\text{F}$

NCP136

TYPICAL CHARACTERISTICS (continued)

At $T_J = +25^\circ\text{C}$, $V_{IN} = V_{OUT(NOM)} + 0.3\text{ V}$, $V_{BIAS} = 2.8\text{ V}$, $V_{EN} = V_{BIAS}$, $V_{OUT(NOM)} = 1.2\text{ V}$, $I_{OUT} = 700\text{ mA}$, $C_{IN} = 4.7\text{ }\mu\text{F}$, $C_{BIAS} = 1\text{ }\mu\text{F}$, and $C_{OUT} = 10\text{ }\mu\text{F}$ (effective capacitance), unless otherwise noted.

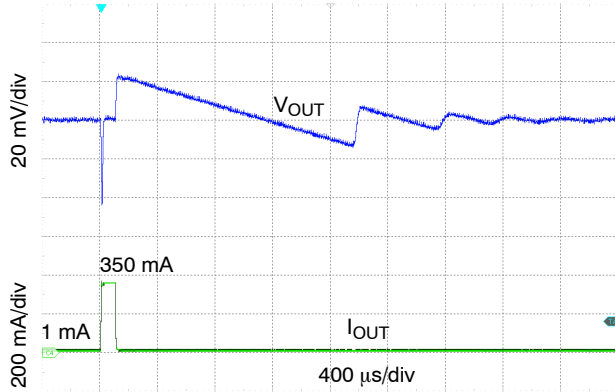

Figure 15. Load Transient Response,
 $I_{OUT} = 1\text{ mA}$ to 350 mA in $1\text{ }\mu\text{s}$, $C_{OUT} = 47\text{ }\mu\text{F}$

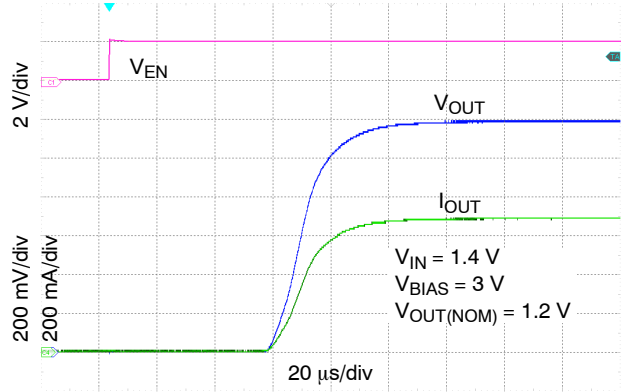

Figure 16. Enable Transient Response, $C_{OUT} = 10\text{ }\mu\text{F}$,
 $I_{OUT} = 700\text{ mA}$ – A Option (Normal)

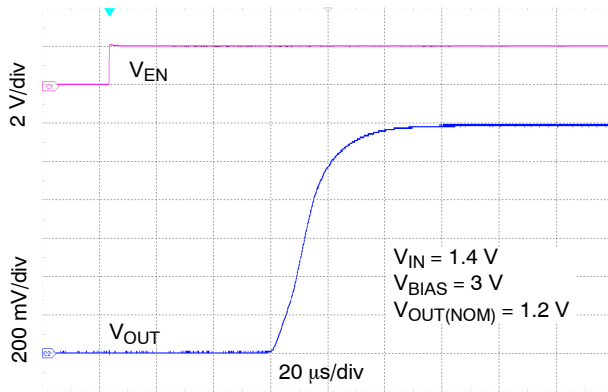

Figure 17. Enable Transient Response, $C_{OUT} = 10\text{ }\mu\text{F}$,
 $I_{OUT} = 0\text{ mA}$ – A Option (Normal)

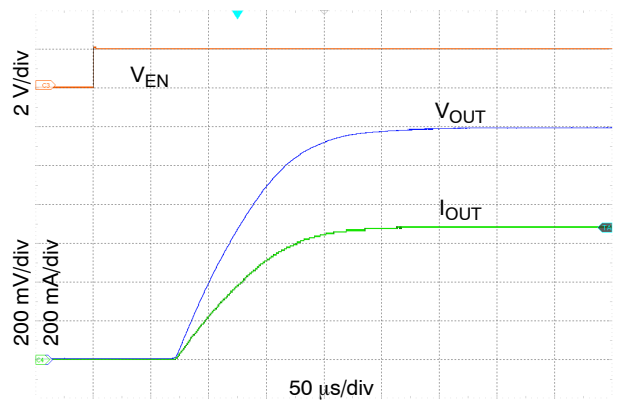

Figure 18. Enable Transient Response,
 $C_{OUT} = 10\text{ }\mu\text{F}$, $I_{OUT} = 700\text{ mA}$ – C Option (Slow)

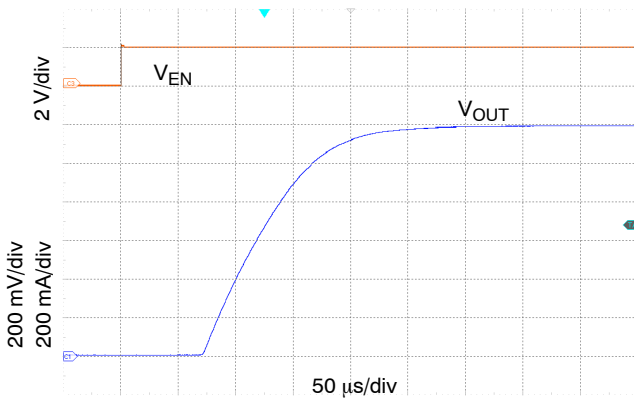

Figure 19. Enable Transient Response,
 $C_{OUT} = 10\text{ }\mu\text{F}$, $I_{OUT} = 0\text{ mA}$ – C Option (Slow)

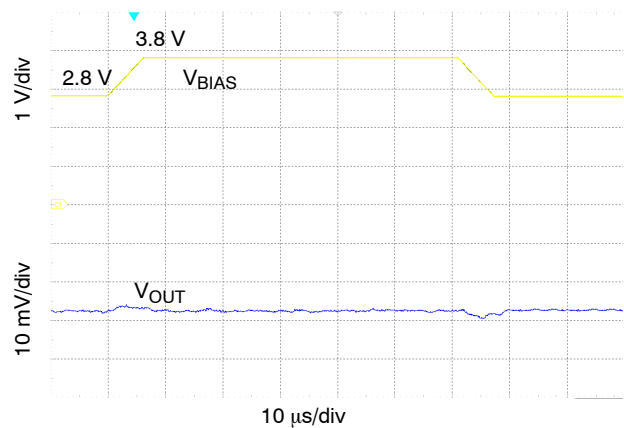
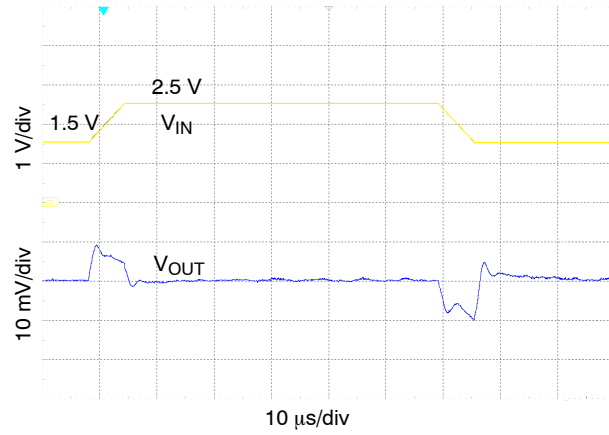

Figure 20. BIAS Line Transient Response,
 $V_{BIAS} = 2.8\text{ V}$ to 3.8 V in $5\text{ }\mu\text{s}$

NCP136

TYPICAL CHARACTERISTICS (continued)

At $T_J = +25^\circ\text{C}$, $V_{IN} = V_{OUT(\text{NOM})} + 0.3\text{ V}$, $V_{BIAS} = 2.8\text{ V}$, $V_{EN} = V_{BIAS}$, $V_{OUT(\text{NOM})} = 1.2\text{ V}$, $I_{OUT} = 700\text{ mA}$, $C_{IN} = 4.7\text{ }\mu\text{F}$, $C_{BIAS} = 1\text{ }\mu\text{F}$, and $C_{OUT} = 10\text{ }\mu\text{F}$ (effective capacitance), unless otherwise noted.



**Figure 21. IN Line Transient Response,
 $V_{IN} = 1.5\text{ V}$ to 2.5 V in $5\text{ }\mu\text{s}$**

APPLICATIONS INFORMATION

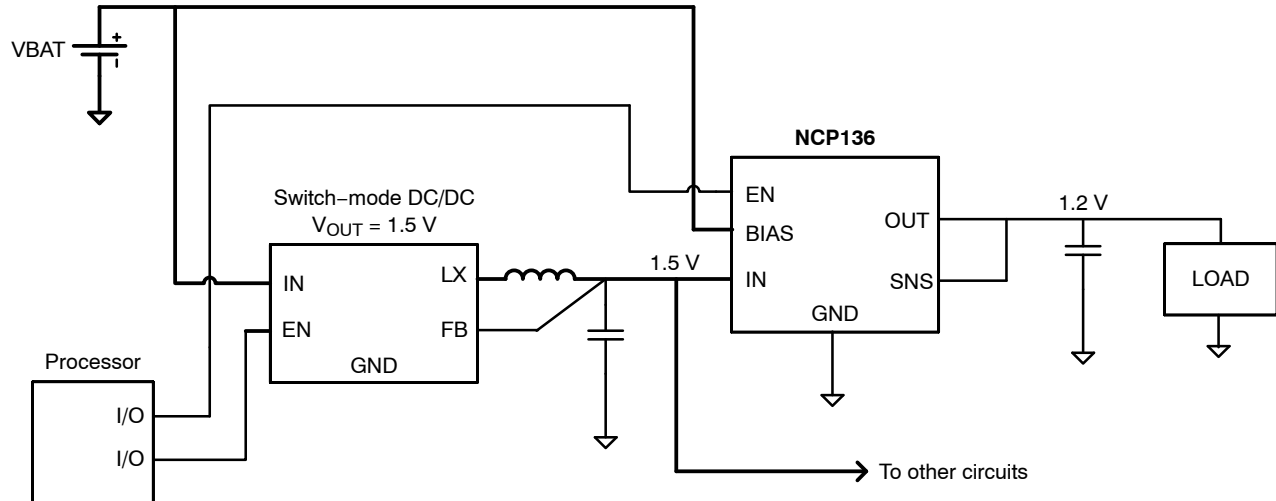

Figure 22. Typical Application: Low-Voltage DC/DC Post-Regulator with ON/OFF Functionality

The NCP136 dual-rail very low dropout voltage regulator is using NMOS pass transistor for output voltage regulation from V_{IN} voltage. All the low current internal control circuitry is powered from the V_{BIAS} voltage.

The use of an NMOS pass transistor offers several advantages in applications. Unlike PMOS topology devices, the output capacitor has reduced impact on loop stability. V_{in} to V_{out} operating voltage difference can be very low compared with standard PMOS regulators in very low V_{in} applications.

The NCP136 offers smooth monotonic start-up. The controlled voltage rising limits the inrush current.

The Enable (EN) input is equipped with internal hysteresis. NCP136 Voltage linear regulator Fixed version is available.

Dropout Voltage

Because of two power supply inputs V_{IN} and V_{BIAS} and one V_{OUT} regulator output, there are two Dropout voltages specified.

The first, the V_{IN} Dropout voltage is the voltage difference ($V_{IN} - V_{OUT}$) when V_{OUT} starts to decrease by percent specified in the Electrical Characteristics table. V_{BIAS} is high enough; specific value is published in the Electrical Characteristics table.

The second, V_{BIAS} dropout voltage is the voltage difference ($V_{BIAS} - V_{OUT}$) when V_{IN} and V_{BIAS} pins are joined together and V_{OUT} starts to decrease.

Input and Output Capacitors

The NCP136 device is designed to be stable for ceramic output capacitors with Effective capacitance in the range from $4.7 \mu\text{F}$ to $47 \mu\text{F}$. The device is also stable with multiple capacitors in parallel, having the total effective capacitance in the specified range.

In applications where no low input supplies impedance available (PCB inductance in V_{IN} and/or V_{BIAS} inputs as example), the recommended $C_{IN} = 1 \mu\text{F}$ and $C_{BIAS} = 0.1 \mu\text{F}$ or greater. Ceramic capacitors are recommended. For the best performance all the capacitors should be connected to the NCP136 respective pins directly in the device PCB copper layer, not through vias having not negligible impedance.

When using small ceramic capacitor, their capacitance is not constant but varies with applied DC biasing voltage, temperature and tolerance. The effective capacitance can be much lower than their nominal capacitance value, most importantly in negative temperatures and higher LDO output voltages. That is why the recommended Output capacitor capacitance value is specified as Effective value in the specific application conditions.

NCP136

Enable Operation

The enable pin will turn the regulator on or off. The threshold limits are covered in the electrical characteristics table in this data sheet. To get the full functionality of Soft Start, it is recommended to turn on the V_{IN} and V_{BIAS} supply voltages first and activate the Enable pin no sooner than V_{IN} and V_{BIAS} are on their nominal levels. If the enable function is not to be used then the pin should be connected to V_{IN} or V_{BIAS} .

If the EN pin voltage is $< 0.4\text{ V}$ the device is guaranteed to be disabled. The pass transistor is turned off so that there is virtually no current flow between the IN and OUT. The active discharge transistor is active (devices with Output Active Discharge feature only) so that the output voltage V_{OUT} is pulled down to GND through a $150\ \Omega$ resistor. In the disable state the device consumes as low as typ. $0.5\ \mu\text{A}$ from the V_{IN} and $0.5\ \mu\text{A}$ from V_{BIAS} . If the EN pin voltage $> 0.9\text{ V}$ the device is guaranteed to be enabled. The NCP136 regulates the output voltage and the active discharge transistor is turned off. The EN pin has internal pull-down

current source with typ. value of $0.3\ \mu\text{A}$ which assures that the device is turned off when the EN pin is not connected.

Current Limitation

The internal Current Limitation circuitry allows the device to supply the full nominal current and surges but protects the device against Current Overload or Short.

Thermal Protection

Internal thermal shutdown (TSD) circuitry is provided to protect the integrated circuit in the event that the maximum junction temperature is exceeded. When TSD activated, the regulator output turns off. When cooling down under the low temperature threshold, device output is activated again. This TSD feature is provided to prevent failures from accidental overheating.

Activation of the thermal protection circuit indicates excessive power dissipation or inadequate heatsinking. For reliable operation, junction temperature should be limited to $+105^{\circ}\text{C}$ maximum.

ORDERING INFORMATION

Device	Nominal Output Voltage	Marking	Option	Package	Shipping†
NCP136AFCT080T2G	0.80 V	7A	Output Active Discharge, Normal Turn-On Slew Rate	WLCSP6 Case 567XK (Pb-Free)	5000 / Tape & Reel
NCP136BFCT080T2G	0.80 V	7H	Non – Active Discharge, Normal Turn-On Slew Rate		
NCP136AFCT088T2G	0.88 V	7J	Output Active Discharge, Normal Turn-On Slew Rate		
NCP136AFCT105T2G	1.05 V	7K	Output Active Discharge, Normal Turn-On Slew Rate		
NCP136AFCT110T2G	1.10 V	7L	Output Active Discharge, Normal Turn-On Slew Rate		
NCP136AFCT120T2G	1.20 V	7E	Output Active Discharge, Normal Turn-On Slew Rate		
NCP136CFCT120T2G	1.20 V	7C	Output Active Discharge, Slow Turn-On Slew Rate		
NCP136AFCRC040T2G (In Development)	0.40 V	7M	Output Active Discharge, Normal Turn-On Slew Rate Back Side Coating	WLCSP6 Case 567YU (Pb-Free)	5000 / Tape & Reel
NCP136AFCRC080T2G (In Development)	0.80 V	7A	Output Active Discharge, Normal Turn-On Slew Rate Back Side Coating		

†For information on tape and reel specifications, including part orientation and tape sizes, please refer to our Tape and Reel Packaging Specifications Brochure, BRD8011/D.

To order other package and voltage variants, please contact your ON Semiconductor sales representative.

NCP136

PACKAGE DIMENSIONS

WLCSP6 1.4x0.8x0.33
CASE 567XK
ISSUE O

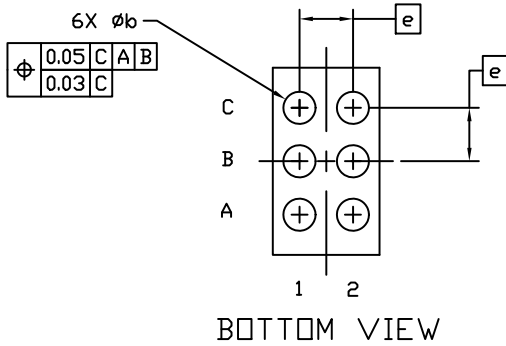
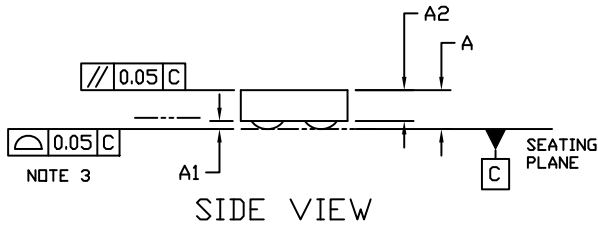
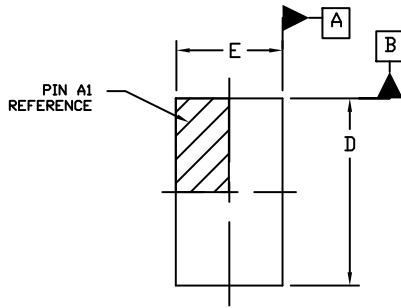

NOTES:

1. DIMENSIONING AND TOLERANCING PER ASME Y14.5M, 1994.
2. CONTROLLING DIMENSION: MILLIMETERS
3. COPLANARITY APPLIES TO THE SPHERICAL CROWNS OF THE SOLDER BALLS.

DIM	MILLIMETERS		
	MIN.	NOM.	MAX.
A	---	---	0.33
A1	0.040	0.060	0.080
A2	0.23 REF		
b	0.220	0.240	0.260
D	1.370	1.400	1.430
E	0.770	0.800	0.830
e	0.40 BSC		

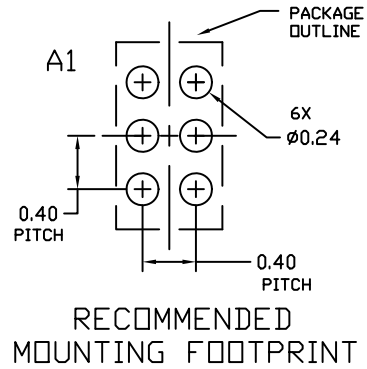

NCP136

PACKAGE DIMENSIONS

WLCSP6 1.4x0.8x0.37
CASE 567YU
ISSUE O

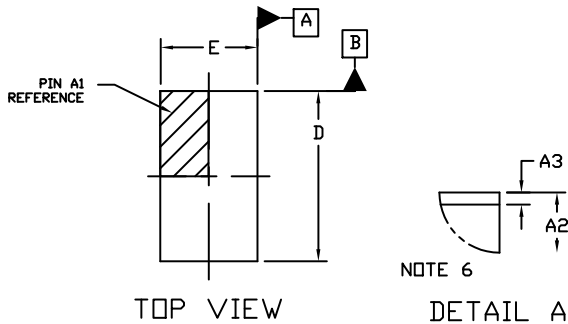

NOTES:

1. DIMENSIONING AND TOLERANCING PER ASME Y14.5M, 1994.
2. CONTROLLING DIMENSION: MILLIMETERS
3. COPLANARITY APPLIES TO THE SPHERICAL CROWNS OF THE SOLDER BALLS.
4. DATUM C, THE SEATING PLANE, IS DEFINED BY THE SPHERICAL CROWNS OF THE SOLDER BALLS.
5. DIMENSION b IS MEASURED AT THE MAXIMUM SOLDER BALL DIAMETER PARALLEL TO DATUM C.
6. BACKSIDE COATING IS OPTIONAL.

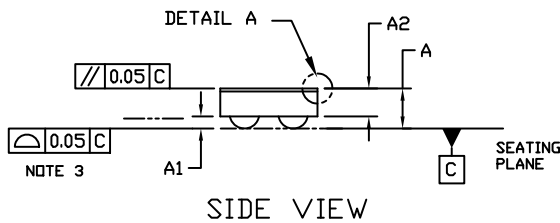

DIM	MILLIMETERS		
	MIN.	NOM.	MAX.
A	---	0.330	0.370
A1	0.080	0.100	0.120
A2	0.230 REF		
A3	0.020	0.025	0.030
b	0.220	0.240	0.260
D	1.370	1.400	1.430
E	0.770	0.800	0.830
e	0.400 BSC		

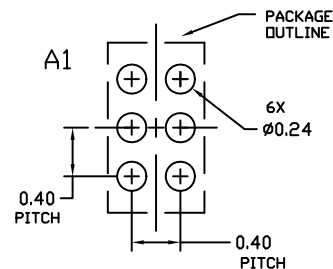
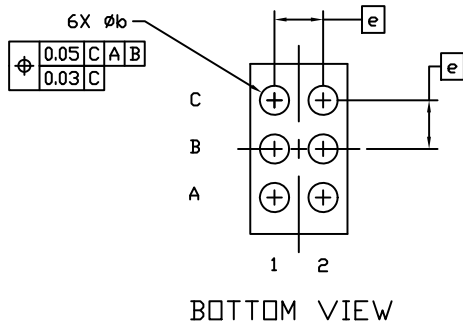

RECOMMENDED MOUNTING FOOTPRINT

- * For additional information on our Pb-Free strategy and soldering details, please download the ON Semiconductor Soldering and Mounting Techniques Reference Manual, SOLDERRM/D.

ON Semiconductor and are trademarks of Semiconductor Components Industries, LLC dba ON Semiconductor or its subsidiaries in the United States and/or other countries. ON Semiconductor owns the rights to a number of patents, trademarks, copyrights, trade secrets, and other intellectual property. A listing of ON Semiconductor's product/patent coverage may be accessed at www.onsemi.com/site/pdf/Patent-Marketing.pdf. ON Semiconductor reserves the right to make changes without further notice to any products herein. ON Semiconductor makes no warranty, representation or guarantee regarding the suitability of its products for any particular purpose, nor does ON Semiconductor assume any liability arising out of the application or use of any product or circuit, and specifically disclaims any and all liability, including without limitation special, consequential or incidental damages. Buyer is responsible for its products and applications using ON Semiconductor products, including compliance with all laws, regulations and safety requirements or standards, regardless of any support or applications information provided by ON Semiconductor. "Typical" parameters which may be provided in ON Semiconductor data sheets and/or specifications can and do vary in different applications and actual performance may vary over time. All operating parameters, including "Typicals" must be validated for each customer application by customer's technical experts. ON Semiconductor does not convey any license under its patent rights nor the rights of others. ON Semiconductor products are not designed, intended, or authorized for use as a critical component in life support systems or any FDA Class 3 medical devices or medical devices with a same or similar classification in a foreign jurisdiction or any devices intended for implantation in the human body. Should Buyer purchase or use ON Semiconductor products for any such unintended or unauthorized application, Buyer shall indemnify and hold ON Semiconductor and its officers, employees, subsidiaries, affiliates, and distributors harmless against all claims, costs, damages, and expenses, and reasonable attorney fees arising out of, directly or indirectly, any claim of personal injury or death associated with such unintended or unauthorized use, even if such claim alleges that ON Semiconductor was negligent regarding the design or manufacture of the part. ON Semiconductor is an Equal Opportunity/Affirmative Action Employer. This literature is subject to all applicable copyright laws and is not for resale in any manner.

PUBLICATION ORDERING INFORMATION

LITERATURE FULFILLMENT:
Email Requests to: orderlit@onsemi.com

TECHNICAL SUPPORT
North American Technical Support:
Voice Mail: 1 800-282-9855 Toll Free USA/Canada
Phone: 011 421 33 790 2910

Europe, Middle East and Africa Technical Support:
Phone: 00421 33 790 2910
For additional information, please contact your local Sales Representative