

## Features

- Medium Body Design
- Solid Ceramic Construction
- No Internal Dendrite Growth
- Requires 30% Less Board Space Than Molded Products of the Same Power Rating
- Meets EIA PDP SOGN-0001 Outline
- Packaged in Tape & Reel or Slide Packs
- Application Specific Circuits Are Available
- Compatible With All Solder Processes Wave, IR Reflow, Vapor Phase Reflow
- RoHS Compliant Version Available

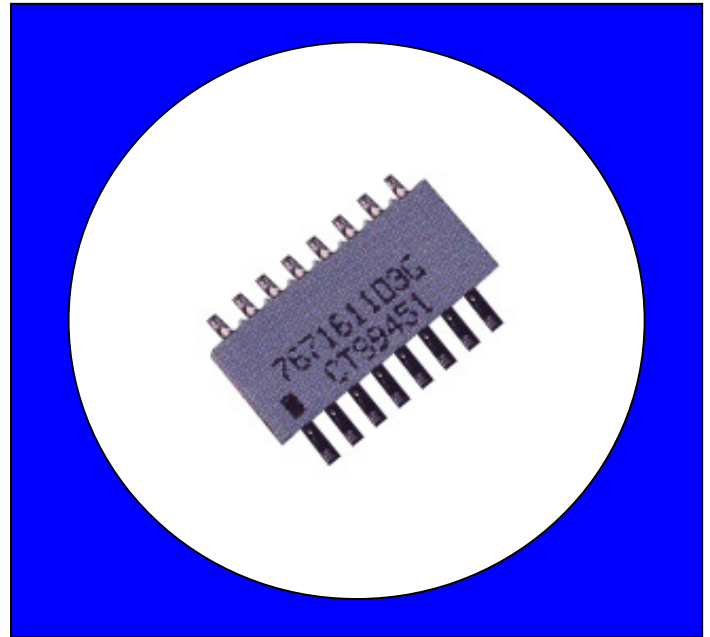

### Resistance Tolerance:

Standard:  $\pm 2\%$  or  $0.5\Omega$  (whichever is greater)  
 Special:  $\pm 0.25\%$  or  $0.3\Omega$  (whichever is greater)

### Resistance Range:

Standard:  $10\Omega$  to 1 Meg $\Omega$

### Operating Temperature Range:

$-55^{\circ}\text{C}$  to  $+125^{\circ}\text{C}$

### Dielectric Strength:

100 VAC

### Temperature Coefficient:

Standard: 100 $\Omega$  to 1 Meg $\Omega$   
 100PPM/ $^{\circ}\text{C}$  typical  
 10 $\Omega$  to 99 $\Omega$   
 $\pm 200\text{PPM}/^{\circ}\text{C}$  typical

### Maximum Operating Voltage:

50V not to exceed rated power

### Power Rating (Total Network Power):

	14 Pin	16 Pin
@25 $^{\circ}\text{C}$	2.0w	2.3w
@70 $^{\circ}\text{C}$	1.3w	1.5w

### Maximum Resistor Power:

(Not to Exceed Total Network Power)

Schematic	1	3	5	7
@25 $^{\circ}\text{C}$	0.15w	0.30w	0.15w	0.15w
@70 $^{\circ}\text{C}$	0.10w	0.20w	0.10w	0.10w

## Types of Circuits

**Bussed (Schematic 1)**

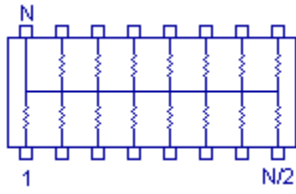

**Isolated (Schematic 3)**

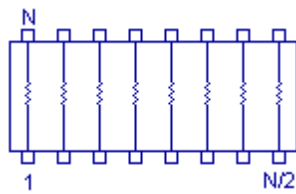

**Dual Terminator (Schematic 5)**

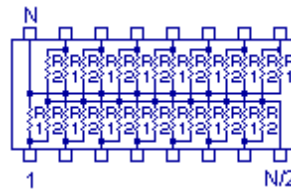

**R/2R Ladder (Schematic 7)**

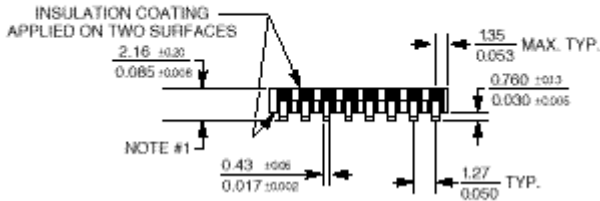
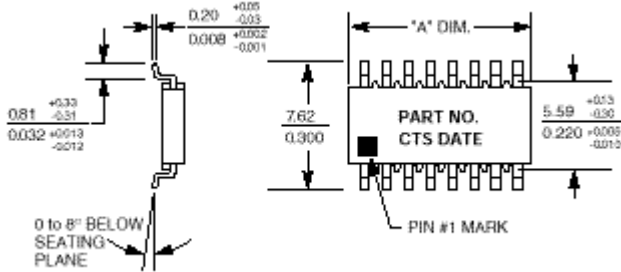
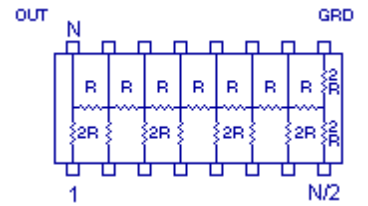

No. of Pins	"A" Dimension	
	mm	in.
14	9.91 ±0.25	0.390 ±0.010
16	11.18 ±0.25	0.440 ±0.010
Notes		
1. Lead COPLANARITY	mm 0.10 MAX in. 0.004	
2. General Tolerances	mm ±0.25 in. ±0.010	
3. mm & in. DIMENSIONS ARE NOT EQUIVALENT		

## Land Patterns

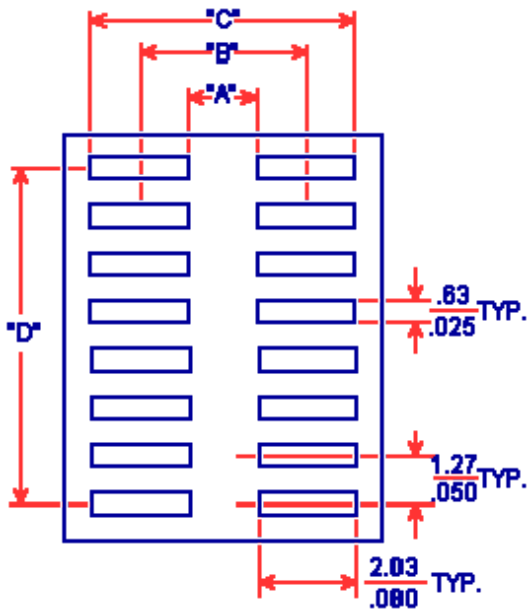

LEAD COUNT		A	B	C	D
14P	mm	5.34	7.37	9.40	7.60
	in.	0.21	0.29	0.37	0.30
16P	mm	5.34	7.37	9.40	7.60
	in.	0.21	0.29	0.37	0.35

## Standard Resistor Values & EIA Code

Ohms	Code	Ohms	Code	Ohms	Code	Ohms	Code	Ohms	Code	Ohms	Code
0	000X	68	680	470	471	3.3K	332	27K	273	220K	224
10	100	75	750	510	511	3.9K	392	33K	333	270K	274
12	120	82	820	560	561	4.7K	472	39K	393	330K	334
15	150	100	101	680	681	5.1K	512	47K	473	390K	394
18	180	110	111	820	821	5.6K	562	51K	513	470K	474
22	220	120	121	1K	102	6.8K	682	56K	563	510K	514
27	270	150	151	1.2K	122	8.2K	822	68K	683	560K	564
33	330	180	181	1.5K	152	10K	103	82K	823	680K	684
39	390	220	221	1.8K	182	12K	123	100K	104	820K	824
47	470	270	271	2.0K	202	15K	153	120K	124	1M	105
51	510	330	331	2.2K	222	18K	183	150K	154		
56	560	390	391	2.7K	272	22K	223	180K	184		

## Dual Terminator Resistor Values

The Series 766, 767, 768 part numbers include the EIA Code value of the Thevenin equivalent resistances of R1 and R2. The Thevenin equivalent resistance is calculated in the following way: The suffix letter relates only to the sequence of variations that equal the same equivalent resistance. Reference chart.

$$R_{eq} = R_1 R_2 / (R_1 + R_2)$$

Examples:			
766165131A	R1=220 Ohms	R2=330 Ohms	Req=132 Ohms
767145191A	R1=330 Ohms	R2=470 Ohms	Req=194 Ohms
768205131C	R1=180 Ohms	R2=470 Ohms	Req=130 Ohms

Pin N/2 is common to R2 and Pin N is common to R1 on CTS Series 766, 767 and 768.

R1	R2	Thevenin Equivalent	CTS Code	R1	R2	Thevenin Equivalent	CTS Code
Ohms				Ohms			
25	50	17 ohm	150A	81	130	50 ohm	500A
30	50	19 ohm	190A	81	2.2K	78 ohm	780A
30	620	29 ohm	290A	100	200	67 ohm	670B
33	4.7K	33 ohm	330A	100	430	81 ohm	810A
36	620	34 ohm	340A	100	150	60 ohm	600A
43	620	40 ohm	400A	106	169	65 ohm	650A
68	189	50 ohm	500B	110	220	73 ohm	730A
75	620	67 ohm	670A	118	178	71 ohm	710A
80	220	59 ohm	590A	120	200	75 ohm	750B

R1	R2	Thevenin Equivalent	CTS Code	R1	R2	Thevenin Equivalent	CTS Code
Ohms				Ohms			
120	180	72 ohm	720A	390	620	239 ohm	241A
120	120	60 ohm	600B	470	1K	320 ohm	321A
150	150	75 ohm	750A	470	680	278 ohm	281A
160	260	99 ohm	990A	470	940	313 ohm	311A
160	240	96 ohm	960A	500	500	250 ohm	251A
160	270	100 ohm	101D	560	910	347 ohm	351A
162	260	100 ohm	101B	560	1K	359 ohm	361A
180	300	113 ohm	111B	680	1K	405 ohm	401A
180	470	130 ohm	131C	750	750	375 ohm	381A
180	390	123 ohm	121A	750	2.3K	566 ohm	571A
180	270	108 ohm	111A	1K	3.3K	767 ohm	771A
180	220	99 ohm	101A	1K	2K	667 ohm	671A
200	1.5K	176 ohm	171D	1.1K	2.2K	733 ohm	731A
220	330	132 ohm	131A	1.2K	1.2K	600 ohm	601A
220	270	121 ohm	121B	1.5K	1.5K	750 ohm	751A
220	220	110 ohm	111D	1.5K	3.3K	1031 ohm	102A
240	170	100 ohm	101C	2K	2K	1000 ohm	102B
240	620	173 ohm	171C	2.2K	5.6K	1579 ohm	162A
250	250	125 ohm	131B	2.2K	4.4K	1467 ohm	152A
270	470	171 ohm	171A	2.2K	3.3K	1320 ohm	132A
270	180	108 ohm	111C	3K	6.2K	2022 ohm	202A
271	131	88 ohm	880A	3K	2K	1200 ohm	122A
330	470	194 ohm	191A	3.3K	4.7K	1939 ohm	192A
330	680	222 ohm	221A	3.9K	3.3K	1788 ohm	182A
330	390	179 ohm	181A	4.7K	22K	3873 ohm	392A
330	220	132 ohm	131D	5K	5K	2500 ohm	252A
330	330	165 ohm	171B	6.8K	22K	5194 ohm	522A
360	720	240 ohm	241B	10K	51K	8361 ohm	842A
360	600	225 ohm	231A	50K	100K	33,333 ohm	333A

1. All tolerances +/-2%. 2. Other values available on request. 3. Suffix letter has no significance - assigned in sequential order.

### How to Order

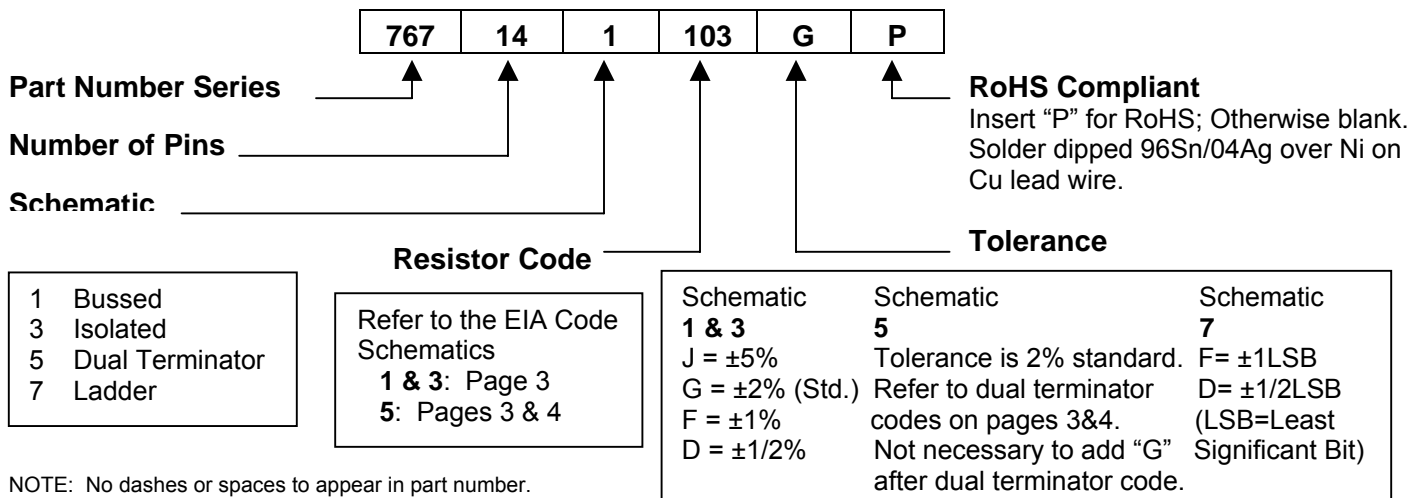

## Packaging

Tape & Reel	14P	16P
Tape width	24mm	24mm
Tape pitch	12mm	12mm
Reel diameter	13"	13"
#parts/reel	2,000	2,000
Slide Packs		
Tube length	20"	20"
#parts/slide pac	48	43

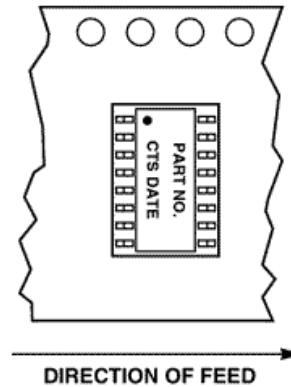

## Environmental Performance Specifications

Test	Max. % Delta R	Mil. Std. 202 Method	Test Cond.	Test Description
Thermal Cycling	0.25%	107	B	5 cycles, -65°C to +125°C
Short Time Overload	0.25%			2 1/2 x rated voltage, 5 sec (100V Max.)
Moisture Resistance	0.5%	106		240 hours, 0.1 rated load, -10°C to +65°C, 90% RH
Load Humidity	1.0%			1000 hours, 0.1 rated load, 70°C, 85-92% RH
High Temp Exposure	1.0%			240 hours, no load, @ 125°C
Load Life	1.0%	108	F	2000 hours @ 70°C rated load
Resistance to Solder Heat	0.25%			30 seconds @ 218°C, dwell
Mechanical Shock	0.25%	213	I	100g, 1 msec., 3 shocks each plane
Vibration	0.25%	204	D	20g, 10-2000Hz, 4 hours/plane
Terminal Strength	0.25%			0.9 Kg. Pull, 30 sec., two 45° bends
Low Temp Storage	0.25%			24 hours @ -65°C, no load
Low Temp Operation	0.25%			45 min @ -65°C, full load
Flammability	N/A			94V-0
Non-Fungus per MIL-STD 810C				
Resistance to Solvents				Isopropyl alcohol
Solderability				RMA Flux, 230°C, 5 seconds dip, 95% coverage