

**Small Signal Diode**

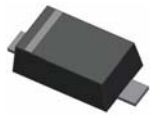

**Features**

- ✧ Wide zener voltage range selection : 2.4V to 75V
- ✧ Vz Tolerance Selection of ±2%
- ✧ Moisture sensitivity level 1
- ✧ Matte Tin(Sn) lead finish with Nickel(Ni) underplate
- ✧ Pb free version and RoHS compliant
- ✧ Green compound (Halogen free) with suffix "G" on packing code and prefix "G" on date code

**Mechanical Data**

- ✧ Case : Flat lead SOD-123 small outline plastic package
- ✧ Terminal: Matte tin plated, lead free., solderable per MIL-STD-202, Method 208 guaranteed
- ✧ High temperature soldering guaranteed: 260 °C/10s
- ✧ Polarity : Indicated by cathode band
- ✧ Weight : 8.85±0.5 mg

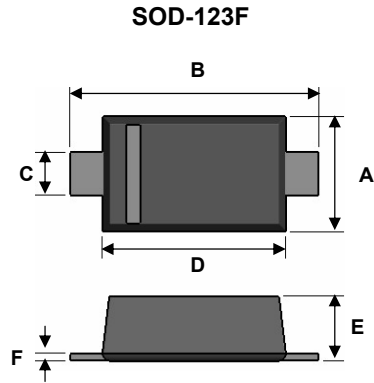

Dimensions	Unit (mm)		Unit (inch)	
	Min	Max	Min	Max
A	1.5	1.7	0.059	0.067
B	3.3	3.7	0.130	0.146
C	0.5	0.7	0.020	0.028
D	2.5	2.7	0.098	0.106
E	0.8	1.0	0.031	0.039
F	0.05	0.2	0.002	0.008

**Ordering Information**

Part No.	Package	Packing
BZT52Bxx RH	SOD-123F	3Kpcs / 7" Reel

**Maximum Ratings and Electrical Characteristics**

Rating at 25°C ambient temperature unless otherwise specified.

**Maximum Ratings**

Type Number	Symbol	Value	Units
Power Dissipation	$P_D$	500	mW
Forward Voltage	$V_F$ (I <sub>F</sub> =10mA)	1	V
Thermal Resistance (Junction to Ambient)	R $\theta$ JA (Note 1)	350	°C/W
Junction and Storage Temperature Range	T <sub>J</sub> , T <sub>STG</sub>	-65 to + 150	°C

Notes:1. Valid provided that electrodes are kept at ambient temperature

**Zener I vs. V Characteristics**

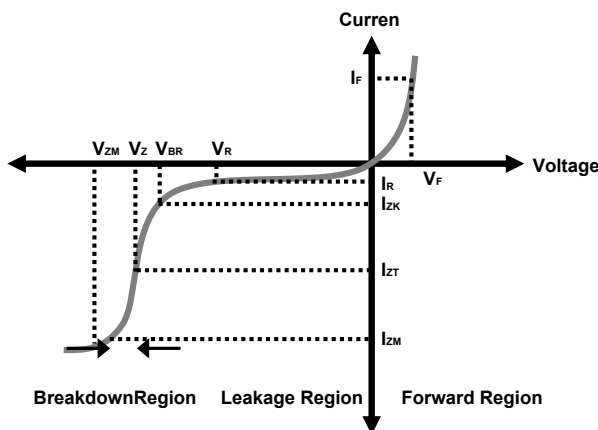

- $V_{BR}$  : Voltage at  $I_{ZK}$
- $I_{ZK}$  : Test current for voltage  $V_{BR}$
- $Z_{ZK}$  : Dynamic impedance at  $I_{ZK}$
- $I_{ZT}$  : Test current for voltage  $V_Z$
- $V_Z$  : Voltage at current  $I_{ZT}$
- $Z_{ZT}$  : Dynamic impedance at  $I_{ZT}$
- $I_{ZM}$  : Maximum steady state current
- $V_{ZM}$  : Voltage at  $I_{ZM}$

**Small Signal Diode**

**Electrical Characteristics**

Ta = 25°C unless otherwise noted

VF Forward Voltage = 1 V Maximum @ IF = 10mA for all part numbers

Part Number	Device Marking	Vz @ IZT (Volt)			IZT(mA)	ZZT @ IZT(Ω) Max	IZK(mA)	ZZK @ IZK(Ω) Max	IR @ VR(μA) Max	VR(V)
		Min	Nom	Max						
BZT52B2V4	2V4B	2.35	2.40	2.45	5	100	1	564	45	1
BZT52B2V7	2V7B	2.65	2.70	2.75	5	100	1	564	18	1
BZT52B3V0	3V0B	2.94	3.00	3.06	5	100	1	564	9	1
BZT52B3V3	3V3B	3.23	3.30	3.37	5	95	1	564	4.5	1
BZT52B3V6	3V6B	3.53	3.60	3.67	5	90	1	564	4.5	1
BZT52B3V9	3V9B	3.82	3.90	3.98	5	90	1	564	2.7	1
BZT52B4V3	4V3B	4.21	4.30	4.39	5	90	1	564	2.7	1
BZT52B4V7	4V7B	4.61	4.70	4.79	5	80	1	470	2.7	2.0
BZT52B5V1	5V1B	5.00	5.10	5.20	5	60	1	451	1.8	2.0
BZT52B5V6	5V6B	5.49	5.60	5.71	5	40	1	376	0.9	2.0
BZT52B6V2	6V2B	6.08	6.20	6.32	5	10	1	141	2.7	4.0
BZT52B6V8	6V8B	6.66	6.80	6.94	5	15	1	75	1.8	4.0
BZT52B7V5	7V5B	7.35	7.50	7.65	5	15	1	75	0.9	5.0
BZT52B8V2	8V2B	8.04	8.20	8.36	5	15	1	75	0.63	5.0
BZT52B9V1	9V1B	8.92	9.10	9.28	5	15	1	94	0.45	6.0
BZT52B10	10VB	9.80	10.00	10.20	5	20	1	141	0.18	7.0
BZT52B11	11VB	10.78	11.00	11.22	5	20	1	141	0.09	8.0
BZT52B12	12VB	11.76	12.00	12.24	5	25	1	141	0.09	8.0
BZT52B13	13VB	12.74	13.00	13.26	5	30	1	160	0.09	8.0
BZT52B15	15VB	14.70	15.00	15.30	5	30	1	188	0.045	10.5
BZT52B16	16VB	15.68	16.00	16.32	5	40	1	188	0.045	11.2
BZT52B18	18VB	17.64	18.00	18.36	5	45	1	212	0.045	12.6
BZT52B20	20VB	19.60	20.00	20.40	5	55	1	212	0.045	14.0
BZT52B22	22VB	21.56	22.00	22.44	5	55	1	235	0.045	15.4
BZT52B24	24VB	23.52	24.00	24.48	5	70	1	235	0.045	16.8
BZT52B27	27VB	26.46	27.00	27.54	2	80	0.5	282	0.045	18.9
BZT52B30	30VB	29.40	30.00	30.60	2	80	0.5	282	0.045	21.0
BZT52B33	33VB	32.34	33.00	33.66	2	80	0.5	306	0.045	23.0
BZT52B36	36VB	35.28	36.00	36.72	2	90	0.5	329	0.045	25.2
BZT52B39	39VB	38.22	39.00	39.78	2	130	0.5	329	0.045	27.3
BZT52B43	43VB	42.14	43.00	43.86	2	150	0.5	353	0.045	30.1
BZT52B47	47VB	46.06	47.00	47.94	2	170	0.5	353	0.045	33.0
BZT52B51	51VB	49.98	51.00	52.02	2	180	0.5	376	0.045	35.7
BZT52B56	56VB	54.88	56.00	57.12	2	200	0.5	400	0.045	39.2
BZT52B62	62VB	60.76	62.00	63.24	2	215	0.5	423	0.045	43.4
BZT52B68	68VB	66.64	68.00	69.36	2	240	0.5	447	0.045	47.6
BZT52B75	75VB	73.50	75.00	76.50	2	255	0.5	470	0.045	52.5

**Notes:**

1. The Zener Voltage (Vz) is tested under pulse condition of 10ms.
2. The device numbers listed have a standard tolerance on the nominal zener voltage of  $\pm 2\%$ .
3. For detailed information on price, availability and delivery of nominal zener voltages between the voltages shown and tighter voltage tolerances, contact your nearest **Taiwan semiconductor** representative.
4. The Zener impedance is derived from the 60-cycle ac voltage, which results when an ac current having an rms value equal to 10% of the dc zener current (IZT or IZK) is superimposed to IZT or IZK.

**Small Signal Diode**

**Rating and Sharacteristic Curves**

**FIG 1 Typical Forward Characteristics**

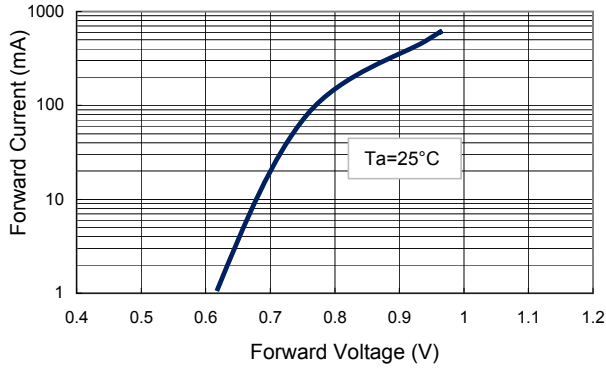

**FIG 2 Zener Breakdown Characteristics**

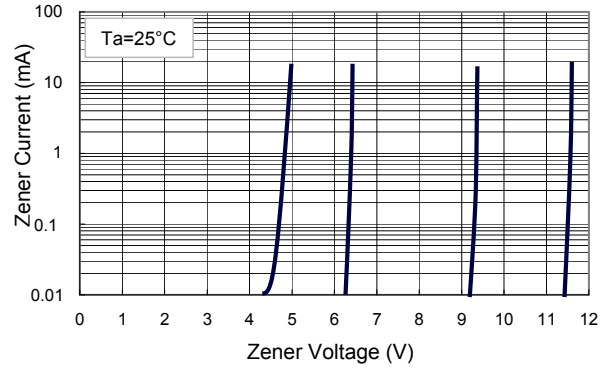

**FIG 3 Zener Breakdown Characteristics**

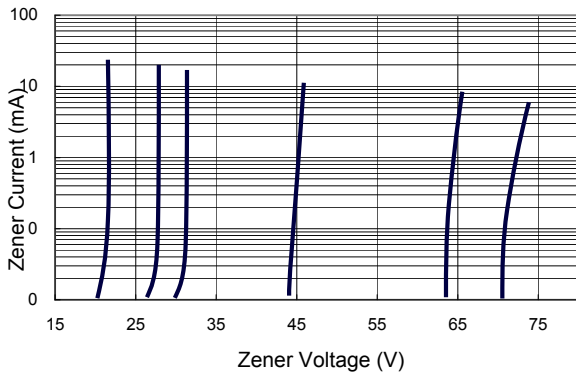

**FIG 4 Admissible Power Dissipation Curve**

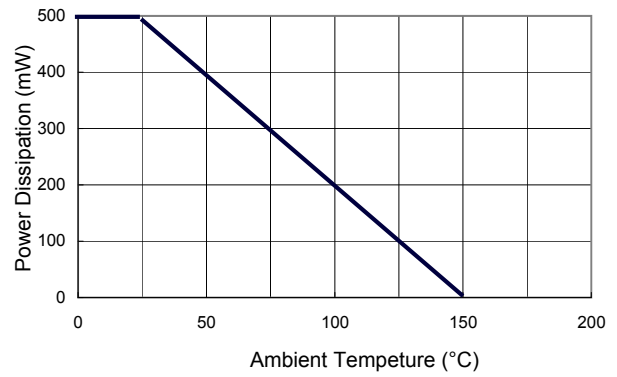

**FIG 5 Typical Capacitance**

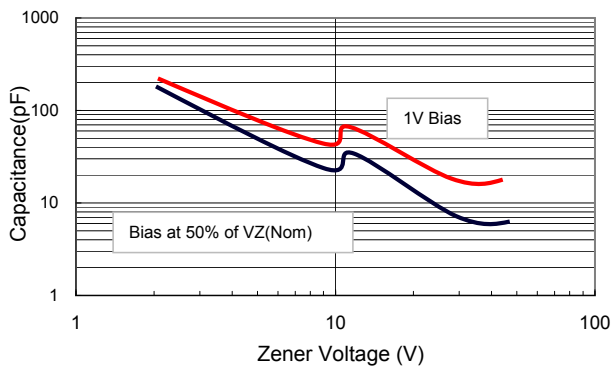

**FIG 6 Effect of Zener Voltage on Impedance**

