

## FEATURES

- isoPower* integrated, isolated dc-to-dc converter
- Regulated 5 V or 3.3 V output
- Up to 400 mW output power
- 16-lead SOIC wide-body package (RW-16)
- 16-lead SOIC wide-body package with enhanced creepage (RI-16-2)
- High temperature operation: 105°C maximum
- High common-mode transient immunity: >25 kV/μs
- Thermal overload protection
- Safety and regulatory approvals
  - UL recognition
    - 5000 V rms for 1 minute per UL 1577
  - CSA Component Acceptance Notice #5A (pending)
    - IEC 60601-1: 250 V rms, 8 mm package (RI-16-2)
    - IEC 60950-1: 400 V rms, 8 mm package (RI-16-2)
  - VDE certificate of conformity (RW-16) (pending)
    - IEC 60747-5-2 (VDE 0884 Part 2):2003-01
    - $V_{IORM} = 846$  V peak
  - VDE certificate of conformity (RI-16-2)
    - DIN V VDE V 0884-10 (VDE V 0884-10):2006-12
    - $V_{IORM} = 846$  V peak

## APPLICATIONS

- USB peripheral power
- RS-232/RS-422/RS-485 transceiver power
- Industrial field bus power
- Industrial PLCs

## GENERAL DESCRIPTION

The ADuM6000<sup>1</sup> is an isolated dc-to-dc converter based on the Analog Devices, Inc., *iCoupler*® technology. The dc-to-dc converter in this device provides regulated, isolated power in several combinations of input and output voltages as listed in Table 1.

The Analog Devices chip scale transformer *iCoupler* technology transfers isolated power in this dc-to-dc converter with up to 31% efficiency. The result is a small form factor, total isolation solution.

Higher output power levels are obtained by using the ADuM6000 to augment the power output of the ADuM5401, ADuM5402, ADuM5403, ADuM5404, ADuM520x, and ADuM620x *iCouplers* with *isoPower*®.

*isoPower* uses high frequency switching elements to transfer power through its transformer. Special care must be taken during printed circuit board (PCB) layout to meet emissions standards. See the AN-0971 Application Note for board layout recommendations.

Table 1. Power Levels

| Input Voltage | Output Voltage | Output Power |
|---------------|----------------|--------------|
| 5 V           | 5 V            | 400 mW       |
| 5 V           | 3.3 V          | 330 mW       |
| 3.3 V         | 3.3 V          | 132 mW       |

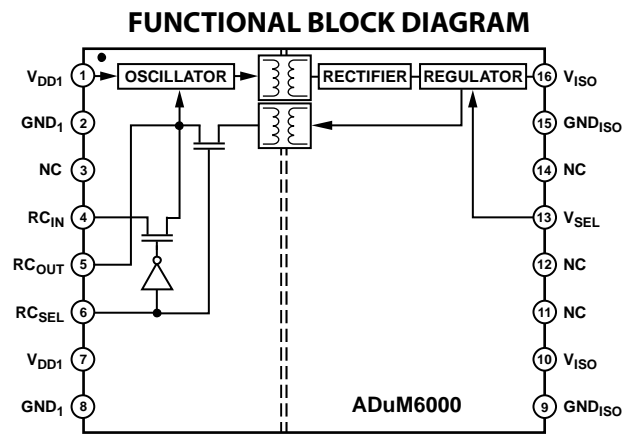

Figure 1.

<sup>1</sup> Protected by U.S. Patents 5,952,849; 6,873,065; 6,903,578; and 7,075,329; other patents pending.

### Rev. D

### Document Feedback

Information furnished by Analog Devices is believed to be accurate and reliable. However, no responsibility is assumed by Analog Devices for its use, nor for any infringements of patents or other rights of third parties that may result from its use. Specifications subject to change without notice. No license is granted by implication or otherwise under any patent or patent rights of Analog Devices. Trademarks and registered trademarks are the property of their respective owners.

## TABLE OF CONTENTS

|  |   |   |    |
|--|---|---|----|
| Features .....   | 1 | Recommended Operating Conditions .....              | 7  |
| Applications .....   | 1 | Absolute Maximum Ratings .....                      | 8  |
| General Description .....  | 1 | ESD Caution.....                                    | 8  |
| Functional Block Diagram .....   | 1 | Pin Configuration and Function Descriptions.....    | 9  |
| Revision History .....   | 2 | Typical Performance Characteristics .....           | 10 |
| Specifications.....  | 3 | Applications Information .....                      | 12 |
| Electrical Characteristics—5 V Primary Input Supply/5 V<br>Secondary Isolated Supply .....                         | 3 | PCB Layout .....                                    | 12 |
| Electrical Characteristics—3.3 V Primary Input Supply/3.3 V<br>Secondary Isolated Supply .....                     | 3 | Start-Up Behavior.....                              | 12 |
| Electrical Characteristics—5 V Primary Input Supply/3.3 V<br>Secondary Isolated Supply .....                       | 4 | EMI Considerations.....                             | 13 |
| Package Characteristics .....  | 4 | Thermal Analysis .....                              | 13 |
| Regulatory Information.....  | 5 | Current Limit and Thermal Overload Protection ..... | 13 |
| Insulation and Safety-Related Specifications.....  | 5 | Power Considerations.....                           | 13 |
| DIN V VDE V 0884-10 (VDE V 0884-10) and IEC 60747-5-2<br>(VDE 0884 Part 2):2003-01 Insulation Characteristics..... | 6 | Increasing Available Power .....                    | 14 |
|  |   | Insulation Lifetime .....                           | 15 |
|  |   | Outline Dimensions .....                            | 16 |
|  |   | Ordering Guide .....                                | 16 |

## REVISION HISTORY

### 7/13—Rev. C to Rev. D

|   |    |
|---|----|
| Changed RI-16-1 Package to RI-16-2 Package (Throughout) ... | 1  |
| Changes to Table 8 and Figure 2.....                        | 6  |
| Updated Outline Dimensions .....                            | 16 |
| Changes to Ordering Guide .....                             | 16 |

### 5/12—Rev. B to Rev. C

|   |    |
|---|----|
| Created Hyperlink for Safety and Regulatory Approvals<br>Entry in Features Section..... | 1  |
| Changes to Ordering Guide .....   | 16 |

### 9/11—Rev. A to Rev. B

|                                  |   |
|----------------------------------|---|
| Change to Features Section ..... | 1 |
| Changes to Table 6.....          | 5 |

### 9/11—Rev. 0 to Rev. A

|  |    |
|--|----|
| Changes to Features and Applications Sections .....  | 1  |
| Changes to Table 6 and Table 7.....  | 5  |
| Changes to DIN V VDE V 0844-10 (VDE V 0884-10) and<br>IEC 60747-5-2 (VDE 0884 Part 2):2003-01 Insulation<br>Characteristics Section..... | 6  |
| Changes to Table 11.....   | 8  |
| Updated Outline Dimensions .....   | 16 |
| Changes to Ordering Guide .....  | 16 |

### 10/10—Revision 0: Initial Version

## SPECIFICATIONS

### ELECTRICAL CHARACTERISTICS—5 V PRIMARY INPUT SUPPLY/5 V SECONDARY ISOLATED SUPPLY

$4.5\text{ V} \leq V_{DD1} \leq 5.5\text{ V}$ ,  $V_{SEL} = V_{ISO}$ ; each voltage is relative to its respective ground. Minimum/maximum specifications apply over the entire recommended operating range, unless otherwise noted. Typical specifications are at  $T_A = 25^\circ\text{C}$ ,  $V_{DD1} = 5.0\text{ V}$ ,  $V_{ISO} = 5.0\text{ V}$ , and  $V_{SEL} = V_{ISO}$ .

Table 2.

| Parameter  | Symbol          | Min | Typ | Max | Unit   | Test Conditions/Comments  |
|--|-----------------|-----|-----|-----|--------|---|
| DC-TO-DC CONVERTER POWER SUPPLY                        |                 |     |     |     |        |   |
| Setpoint   | $V_{ISO}$       | 4.7 | 5.0 | 5.4 | V      | $I_{ISO} = 0\text{ mA}$   |
| Line Regulation  | $V_{ISO(LINE)}$ |     | 1   |     | mV/V   | $I_{ISO} = 40\text{ mA}$ , $V_{DD1} = 4.5\text{ V to }5.5\text{ V}$                                   |
| Load Regulation  | $V_{ISO(LOAD)}$ |     | 1   | 5   | %      | $I_{ISO} = 8\text{ mA to }72\text{ mA}$   |
| Output Ripple  | $V_{ISO(RIP)}$  |     | 75  |     | mV p-p | 20 MHz bandwidth, $C_{BO} = 0.1\text{ }\mu\text{F}  10\text{ }\mu\text{F}$ , $I_{ISO} = 72\text{ mA}$ |
| Output Noise   | $V_{ISO(N)}$    |     | 200 |     | mV p-p | $C_{BO} = 0.1\text{ }\mu\text{F}  10\text{ }\mu\text{F}$ , $I_{ISO} = 72\text{ mA}$                   |
| Switching Frequency                                    | $f_{OSC}$       |     | 180 |     | MHz    |   |
| PWM Frequency  | $f_{PWM}$       |     | 625 |     | kHz    |   |
| $I_{DD1}$ Supply Current, Full $V_{ISO}$ Load          | $I_{DD1(MAX)}$  |     | 290 |     | mA     |   |
| Maximum Output Supply Current                          | $I_{ISO(MAX)}$  | 80  |     |     | mA     | $V_{ISO} > 4.5\text{ V}$  |
| Efficiency at Maximum Output Supply Current            |                 |     | 31  |     | %      | $I_{ISO} = 80\text{ mA}$  |
| $I_{DD1}$ Supply Current, No $V_{ISO}$ Load            | $I_{DD1(Q)}$    |     | 7   | 16  | mA     | $I_{ISO} = 0\text{ mA}$   |
| Undervoltage Lockout, $V_{DD1}$ and $V_{ISO}$ Supplies |                 |     |     |     |        |   |
| Positive-Going Threshold                               | $V_{UV+}$       |     | 2.7 |     | V      |   |
| Negative-Going Threshold                               | $V_{UV-}$       |     | 2.4 |     | V      |   |
| Hysteresis   | $V_{UVH}$       |     | 0.3 |     | V      |   |

### ELECTRICAL CHARACTERISTICS—3.3 V PRIMARY INPUT SUPPLY/3.3 V SECONDARY ISOLATED SUPPLY

$3.0\text{ V} \leq V_{DD1} \leq 3.6\text{ V}$ ,  $V_{SEL} = \text{GND}_{ISO}$ ; each voltage is relative to its respective ground. Minimum/maximum specifications apply over the entire recommended operating range, unless otherwise noted. Typical specifications are at  $T_A = 25^\circ\text{C}$ ,  $V_{DD1} = 3.3\text{ V}$ ,  $V_{ISO} = 3.3\text{ V}$ , and  $V_{SEL} = \text{GND}_{ISO}$ .

Table 3.

| Parameter  | Symbol          | Min | Typ | Max | Unit   | Test Conditions/Comments  |
|--|-----------------|-----|-----|-----|--------|---|
| DC-TO-DC CONVERTER POWER SUPPLY                        |                 |     |     |     |        |   |
| Setpoint   | $V_{ISO}$       | 3.0 | 3.3 | 3.6 | V      | $I_{ISO} = 0\text{ mA}$   |
| Line Regulation  | $V_{ISO(LINE)}$ |     | 1   |     | mV/V   | $I_{ISO} = 20\text{ mA}$ , $V_{DD1} = 3.0\text{ V to }3.6\text{ V}$                                   |
| Load Regulation  | $V_{ISO(LOAD)}$ |     | 1   | 5   | %      | $I_{ISO} = 4\text{ mA to }36\text{ mA}$   |
| Output Ripple  | $V_{ISO(RIP)}$  |     | 50  |     | mV p-p | 20 MHz bandwidth, $C_{BO} = 0.1\text{ }\mu\text{F}  10\text{ }\mu\text{F}$ , $I_{ISO} = 36\text{ mA}$ |
| Output Noise   | $V_{ISO(N)}$    |     | 130 |     | mV p-p | $C_{BO} = 0.1\text{ }\mu\text{F}  10\text{ }\mu\text{F}$ , $I_{ISO} = 36\text{ mA}$                   |
| Switching Frequency                                    | $f_{OSC}$       |     | 180 |     | MHz    |   |
| PWM Frequency  | $f_{PWM}$       |     | 625 |     | kHz    |   |
| $I_{DD1}$ Supply Current, Full $V_{ISO}$ Load          | $I_{DD1(MAX)}$  |     | 175 |     | mA     |   |
| Maximum Output Supply Current                          | $I_{ISO(MAX)}$  | 40  |     |     | mA     | $V_{ISO} > 3.0\text{ V}$  |
| Efficiency at Maximum Output Supply Current            |                 |     | 31  |     | %      | $I_{ISO} = 40\text{ mA}$  |
| $I_{DD1}$ Supply Current, No $V_{ISO}$ Load            | $I_{DD1(Q)}$    |     | 5   | 13  | mA     | $I_{ISO} = 0\text{ mA}$   |
| Undervoltage Lockout, $V_{DD1}$ and $V_{ISO}$ Supplies |                 |     |     |     |        |   |
| Positive-Going Threshold                               | $V_{UV+}$       |     | 2.7 |     | V      |   |
| Negative-Going Threshold                               | $V_{UV-}$       |     | 2.4 |     | V      |   |
| Hysteresis   | $V_{UVH}$       |     | 0.3 |     | V      |   |

**ELECTRICAL CHARACTERISTICS—5 V PRIMARY INPUT SUPPLY/3.3 V SECONDARY ISOLATED SUPPLY**

$4.5\text{ V} \leq V_{DD1} \leq 5.5\text{ V}$ ,  $V_{SEL} = \text{GND}_{\text{ISO}}$ , each voltage is relative to its respective ground. Minimum/maximum specifications apply over the entire recommended operating range, unless otherwise noted. Typical specifications are at  $T_A = 25^\circ\text{C}$ ,  $V_{DD1} = 5.0\text{ V}$ ,  $V_{\text{ISO}} = 3.3\text{ V}$ , and  $V_{SEL} = \text{GND}_{\text{ISO}}$ .

Table 4.

| Parameter   | Symbol                       | Min | Typ | Max | Unit   | Test Conditions/Comments  |
|---|------------------------------|-----|-----|-----|--------|---|
| <b>DC-TO-DC CONVERTER POWER SUPPLY</b>                        |                              |     |     |     |        |   |
| Setpoint  | $V_{\text{ISO}}$             | 3.0 | 3.3 | 3.6 | V      | $I_{\text{ISO}} = 0\text{ mA}$  |
| Line Regulation   | $V_{\text{ISO(LINE)}}$       |     | 1   |     | mV/V   | $I_{\text{ISO}} = 50\text{ mA}$ , $V_{DD1} = 4.5\text{ V to }5.5\text{ V}$                              |
| Load Regulation   | $V_{\text{ISO(LOAD)}}$       |     | 1   | 5   | %      | $I_{\text{ISO}} = 10\text{ mA to }90\text{ mA}$   |
| Output Ripple   | $V_{\text{ISO(RIP)}}$        |     | 50  |     | mV p-p | 20 MHz bandwidth, $C_{\text{BO}} = 0.1\ \mu\text{F}  10\ \mu\text{F}$ , $I_{\text{ISO}} = 90\text{ mA}$ |
| Output Noise  | $V_{\text{ISO(N)}}$          |     | 130 |     | mV p-p | $C_{\text{BO}} = 0.1\ \mu\text{F}  10\ \mu\text{F}$ , $I_{\text{ISO}} = 90\text{ mA}$                   |
| Switching Frequency   | $f_{\text{OSC}}$             |     | 180 |     | MHz    |   |
| PWM Frequency   | $f_{\text{PWM}}$             |     | 625 |     | kHz    |   |
| $I_{DD1}$ Supply Current, Full $V_{\text{ISO}}$ Load          | $I_{DD1(\text{MAX})}$        |     | 250 |     | mA     |   |
| Maximum Output Supply Current                                 | $I_{\text{ISO}(\text{MAX})}$ | 100 |     |     | mA     | $V_{\text{ISO}} > 3.0\text{ V}$   |
| Efficiency at Maximum Output Supply Current                   |                              |     | 26  |     | %      | $I_{\text{ISO}} = 100\text{ mA}$  |
| $I_{DD1}$ Supply Current, No $V_{\text{ISO}}$ Load            | $I_{DD1(\text{Q})}$          |     | 4   | 12  | mA     | $I_{\text{ISO}} = 0\text{ mA}$  |
| Undervoltage Lockout, $V_{DD1}$ and $V_{\text{ISO}}$ Supplies | UVLO                         |     |     |     |        |   |
| Positive-Going Threshold                                      | $V_{\text{UV+}}$             |     | 2.7 |     | V      |   |
| Negative-Going Threshold                                      | $V_{\text{UV-}}$             |     | 2.4 |     | V      |   |
| Hysteresis  | $V_{\text{UVH}}$             |     | 0.3 |     | V      |   |

**PACKAGE CHARACTERISTICS**

Table 5.

| Parameter                                  | Symbol               | Min | Typ       | Max | Unit               | Test Conditions/Comments  |
|--|----------------------|-----|-----------|-----|--------------------|---|
| <b>RESISTANCE AND CAPACITANCE</b>          |                      |     |           |     |                    |   |
| Resistance (Input-to-Output) <sup>1</sup>  | $R_{\text{I-O}}$     |     | $10^{12}$ |     | $\Omega$           |   |
| Capacitance (Input-to-Output) <sup>1</sup> | $C_{\text{I-O}}$     |     | 2.2       |     | pF                 | $f = 1\text{ MHz}$  |
| Input Capacitance <sup>2</sup>             | $C_{\text{I}}$       |     | 4.0       |     | pF                 |   |
| IC Junction-to-Ambient Thermal Resistance  | $\theta_{\text{JA}}$ |     | 45        |     | $^\circ\text{C/W}$ | Thermocouple is located at the center of the package underside; test conducted on a 4-layer board with thin traces <sup>3</sup> |
| <b>THERMAL SHUTDOWN</b>                    |                      |     |           |     |                    |   |
| Thermal Shutdown Threshold                 | $T_{\text{SSD}}$     |     | 150       |     | $^\circ\text{C}$   | $T_{\text{J}}$ rising   |
| Thermal Shutdown Hysteresis                | $T_{\text{SSD-HYS}}$ |     | 20        |     | $^\circ\text{C}$   |   |

<sup>1</sup> This device is considered a 2-terminal device; Pin 1 through Pin 8 are shorted together, and Pin 9 through Pin 16 are shorted together.

<sup>2</sup> Input capacitance is from any input data pin to ground.

<sup>3</sup> Refer to the Thermal Analysis section for thermal model definitions.

**REGULATORY INFORMATION**

The ADuM6000 is approved by the organizations listed in Table 6. Refer to Table 11 and the Insulation Lifetime section for more information about the recommended maximum working voltages for specific cross-isolation waveforms and insulation levels.

**Table 6.**

| UL <sup>1</sup>  | CSA   | VDE <sup>2</sup>   |
|--|---|--|
| Recognized under UL 1577 component recognition program | Approved under CSA Component Acceptance Notice #5A  | RI-16-2 package:<br>Certified according to DIN V VDE V 0884-10 (VDE V 0884-10):2006-12 <sup>3</sup><br>Reinforced insulation, 846 V peak |
| Single protection, 5000 V rms isolation voltage        | Basic insulation per CSA 60950-1-07 and IEC 60950-1, 600 V rms (848 V peak) maximum working voltage<br><br>RW-16 package:<br>Reinforced insulation per CSA 60950-1-07 and IEC 60950-1, 380 V rms (537 V peak) maximum working voltage<br>Reinforced insulation per IEC 60601-1, 125 V rms (176 V peak) maximum working voltage<br>RI-16-2 package (pending):<br>Reinforced insulation per CSA 60950-1-07 and IEC 60950-1, 400 V rms (565 V peak) maximum working voltage<br>Reinforced insulation per IEC 60601-1, 250 V rms (353 V peak) maximum working voltage | RW-16 package (pending):<br>Certified according to IEC 60747-5-2 (VDE 0884 Part 2):2003-01<br>Basic insulation, 846 V peak               |
| File E214100   | File 205078   | File 2471900-4880-0001   |

<sup>1</sup> In accordance with UL 1577, each ADuM6000 is proof-tested by applying an insulation test voltage  $\geq 6000$  V rms for 1 sec (current leakage detection limit = 15  $\mu$ A).

<sup>2</sup> In accordance with IEC 60747-5-2 (VDE 0884 Part 2):2003-01, each ADuM6000 is proof-tested by applying an insulation test voltage  $\geq 1590$  V peak for 1 sec (partial discharge detection limit = 5 pC). The asterisk (\*) marking branded on the component designates IEC 60747-5-2 (VDE 0884 Part 2):2003-01 approval.

<sup>3</sup> In accordance with DIN V VDE V 0884-10, each ADuM6000 is proof-tested by applying an insulation test voltage  $\geq 1050$  V peak for 1 sec (partial discharge detection limit = 5 pC). The asterisk (\*) marking branded on the component designates DIN V VDE V 0884-10 approval.

**INSULATION AND SAFETY-RELATED SPECIFICATIONS****Table 7.**

| Parameter  | Symbol | Value     | Unit  | Test Conditions/Comments   |
|--|--------|-----------|-------|--|
| Rated Dielectric Insulation Voltage                  |        | 5000      | V rms | 1-minute duration  |
| Minimum External Air Gap (Clearance)                 | L(I01) | 8.0       | mm    | Measured from input terminals to output terminals, shortest distance through air     |
| Minimum External Tracking (Creepage) RW-16 Package   | L(I02) | 7.6       | mm    | Measured from input terminals to output terminals, shortest distance path along body |
| Minimum External Tracking (Creepage) RI-16-2 Package | L(I02) | 8.3 min   | mm    | Measured from input terminals to output terminals, shortest distance path along body |
| Minimum Internal Distance (Internal Clearance)       |        | 0.017 min | mm    | Distance through insulation  |
| Tracking Resistance (Comparative Tracking Index)     | CTI    | >175      | V     | DIN IEC 112/VDE 0303, Part 1   |
| Material Group                                       |        | IIIa      |       | Material Group (DIN VDE 0110, 1/89, Table 1)   |

## DIN V VDE V 0884-10 (VDE V 0884-10) AND IEC 60747-5-2 (VDE 0884 PART 2):2003-01 INSULATION CHARACTERISTICS

This power module is suitable for reinforced electrical isolation only within the safety limit data. Maintenance of the safety data is ensured by protective circuits. The asterisk (\*) marking branded on the component designates DIN V VDE V 0884-10 (VDE V 0884-10) or IEC 60747-5-2 (VDE 0884 Part 2):2003-01 approval.

Table 8.

| Description   | Conditions   | Symbol                    | Characteristic                                   | Unit                |
|---|--|---------------------------|--|---------------------|
| Installation Classification per DIN VDE 0110<br>For Rated Mains Voltage $\leq 150$ V rms<br>For Rated Mains Voltage $\leq 300$ V rms<br>For Rated Mains Voltage $\leq 400$ V rms<br>Climatic Classification<br>Pollution Degree per DIN VDE 0110, Table 1 |  |                           | I to IV<br>I to IV<br>I to III<br>40/105/21<br>2 |                     |
| Maximum Working Insulation Voltage<br>Input-to-Output Test Voltage, Method B1   | $V_{IORM} \times 1.875 = V_{pd(m)}$ , 100% production test, $t_{ini} = t_m = 1$ sec, partial discharge $< 5$ pC                        | $V_{IORM}$<br>$V_{pd(m)}$ | 849<br>1592                                      | V peak<br>V peak    |
| Input-to-Output Test Voltage, Method A  | $V_{IORM} \times 1.5 = V_{pd(m)}$ , $t_{ini} = 60$ sec, $t_m = 10$ sec, partial discharge $< 5$ pC                                     | $V_{pd(m)}$               |  |                     |
| After Environmental Tests Subgroup 1<br>After Input and/or Safety Test Subgroup 2 and Subgroup 3  | $V_{IORM} \times 1.2 = V_{pd(m)}$ , $t_{ini} = 60$ sec, $t_m = 10$ sec, partial discharge $< 5$ pC                                     | $V_{pd(m)}$               | 1273<br>1018                                     | V peak<br>V peak    |
| Highest Allowable Overvoltage<br>Surge Isolation Voltage<br>Safety-Limiting Values  | $V_{PEAK} = 10$ kV, 1.2 $\mu$ s rise time, 50 $\mu$ s, 50% fall time<br>Maximum value allowed in the event of a failure (see Figure 2) | $V_{IOTM}$<br>$V_{IOSM}$  | 6000<br>6000                                     | V peak<br>V peak    |
| Maximum Junction Temperature<br>Total Power Dissipation @ 25°C<br>Insulation Resistance at $T_s$  | $V_{IO} = 500$ V   | $T_s$<br>$P_s$<br>$R_s$   | 150<br>2.78<br>$>10^9$                           | °C<br>W<br>$\Omega$ |

### Thermal Derating Curve

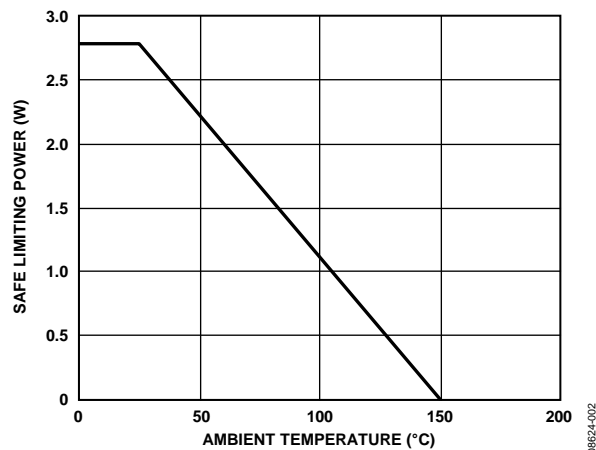

Figure 2. Thermal Derating Curve, Dependence of Safety-Limiting Values on Case Temperature, per DIN EN 60747-5-2

**RECOMMENDED OPERATING CONDITIONS**

Table 9.

| Parameter                            | Symbol    | Min | Max  | Unit | Test Conditions/Comments  |
|--------------------------------------|-----------|-----|------|------|---|
| TEMPERATURE<br>Operating Temperature | $T_A$     | -40 | +105 | °C   | Operation at 105°C requires reduction of the maximum load current, as specified in Table 10 |
| SUPPLY VOLTAGES                      |           |     |      |      | Each voltage is relative to its respective ground   |
| $V_{DD1} @ V_{SEL} = 0V$             | $V_{DD1}$ | 3.0 | 5.5  | V    |   |
| $V_{DD1} @ V_{SEL} = V_{ISO}$        | $V_{DD1}$ | 4.5 | 5.5  | V    |   |

## ABSOLUTE MAXIMUM RATINGS

$T_A = 25^\circ\text{C}$ , unless otherwise noted.

**Table 10.**

| Parameter   | Rating   |
|---|--|
| Storage Temperature ( $T_{ST}$ )                        | $-55^\circ\text{C}$ to $+150^\circ\text{C}$                  |
| Ambient Operating Temperature ( $T_A$ )                 | $-40^\circ\text{C}$ to $+105^\circ\text{C}$                  |
| Supply Voltages ( $V_{DD1}$ , $V_{ISO}$ ) <sup>1</sup>  | $-0.5\text{ V}$ to $+7.0\text{ V}$                           |
| Input Voltage ( $RC_{IN}$ , $RC_{SEL}$ ) <sup>1,2</sup> | $-0.5\text{ V}$ to $V_{DD1} + 0.5\text{ V}$                  |
| Output Voltage ( $RC_{OUT}$ ) <sup>1,2</sup>            | $-0.5\text{ V}$ to $V_{DD0} + 0.5\text{ V}$                  |
| Average Total Output Current ( $I_{ISO}$ ) <sup>3</sup> | 80 mA  |
| Common-Mode Transients <sup>4</sup>                     | $-100\text{ kV}/\mu\text{s}$ to $+100\text{ kV}/\mu\text{s}$ |

<sup>1</sup> Each voltage is relative to its respective ground.

<sup>2</sup>  $V_{DD1}$  and  $V_{DD0}$  refer to the supply voltages on the input and output sides of a given channel, respectively. See the PCB Layout section.

<sup>3</sup> See Figure 2 for maximum rated current values for various temperatures.

<sup>4</sup> Refers to common-mode transients across the isolation barrier. Common-mode transients exceeding the absolute maximum ratings may cause latch-up or permanent damage.

Stresses above those listed under Absolute Maximum Ratings may cause permanent damage to the device. This is a stress rating only; functional operation of the device at these or any other conditions above those indicated in the operational section of this specification is not implied. Exposure to absolute maximum rating conditions for extended periods may affect device reliability.

### ESD CAUTION



**ESD (electrostatic discharge) sensitive device.** Charged devices and circuit boards can discharge without detection. Although this product features patented or proprietary protection circuitry, damage may occur on devices subjected to high energy ESD. Therefore, proper ESD precautions should be taken to avoid performance degradation or loss of functionality.

**Table 11. Maximum Continuous Working Voltage<sup>1</sup>**

| Parameter                     | Max | Unit   | Applicable Certification              |
|-------------------------------|-----|--------|---------------------------------------|
| AC Voltage, Bipolar Waveform  | 424 | V peak | All certifications, 50-year operation |
| AC Voltage, Unipolar Waveform |     |        |                                       |
| Basic Insulation              | 600 | V peak | Working voltage per IEC 60950-1       |
| Reinforced Insulation         | 565 | V peak |                                       |
| DC Voltage                    |     |        |                                       |
| Basic Insulation              | 600 | V peak | Working voltage per IEC 60950-1       |
| Reinforced Insulation         | 565 | V peak |                                       |

<sup>1</sup> Refers to the continuous voltage magnitude imposed across the isolation barrier. See the Insulation Lifetime section for more information.



## PIN CONFIGURATION AND FUNCTION DESCRIPTIONS

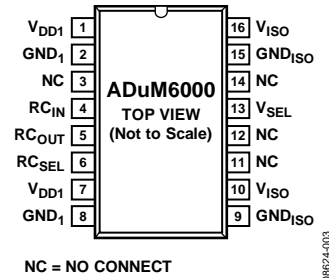

Figure 3. Pin Configuration

Table 12. Pin Function Descriptions

| Pin No.       | Mnemonic           | Description   |
|---------------|--------------------|---|
| 1, 7          | V <sub>DD1</sub>   | Primary Supply Voltage, 3.0 V to 5.5 V. Pin 1 and Pin 7 are internally connected to each other, and it is recommended that both pins be externally connected to a common power source.  |
| 2, 8          | GND <sub>1</sub>   | Ground Reference for the Primary Side of the Converter. Pin 2 and Pin 8 are internally connected to each other, and it is recommended that both pins be connected to a common ground.   |
| 3, 11, 12, 14 | NC                 | No Internal Connection.   |
| 4             | RC <sub>IN</sub>   | Regulation Control Input. In slave power configuration (RC <sub>SEL</sub> low), this pin is connected to the RC <sub>OUT</sub> pin of a master <i>iso</i> Power device, or it is tied low to disable the converter. In master or standalone mode (RC <sub>SEL</sub> high), this pin has no function. This pin is weakly pulled to the low state. In noisy environments, it should be tied low or tied to a PWM control source. This pin must not be tied high if RC <sub>SEL</sub> is low; this combination causes excessive voltage on the secondary side of the converter, damaging the ADuM6000 and possibly the devices that it powers. |
| 5             | RC <sub>OUT</sub>  | Regulation Control Output. In master power configuration (RC <sub>SEL</sub> high), this pin is connected to the RC <sub>IN</sub> pin of a slave <i>iso</i> Power device to allow the ADuM6000 to regulate additional devices.   |
| 6             | RC <sub>SEL</sub>  | Control Input. Sets either standalone/master mode (RC <sub>SEL</sub> high) or slave mode (RC <sub>SEL</sub> low). This pin is weakly pulled to the high state. In noisy environments, tie this pin either high or low.  |
| 9, 15         | GND <sub>ISO</sub> | Ground Reference for the Secondary Side of the Converter. Pin 9 and Pin 15 are internally connected to each other, and it is recommended that both pins be connected to a common ground.  |
| 10, 16        | V <sub>ISO</sub>   | Secondary Supply Voltage Output for External Loads. 3.3 V (V <sub>SEL</sub> low) or 5.0 V (V <sub>SEL</sub> high). The 5.0 V output functionality is not guaranteed for a 3.3 V primary supply input. Pin 10 and Pin 16 are internally connected to each other, and it is recommended that both pins be externally connected.   |
| 13            | V <sub>SEL</sub>   | Output Voltage Selection. When V <sub>SEL</sub> = V <sub>ISO</sub> , the V <sub>ISO</sub> setpoint is 5.0 V. When V <sub>SEL</sub> = GND <sub>ISO</sub> , the V <sub>ISO</sub> setpoint is 3.3 V. This pin is weakly pulled to the high state. In noisy environments, tie this pin either high or low. In slave mode, this pin has no function.   |

Table 13. Truth Table (Positive Logic)

| RC <sub>SEL</sub> Input | RC <sub>IN</sub> Input | RC <sub>OUT</sub> Output | V <sub>SEL</sub> Input | V <sub>DD1</sub> Input | V <sub>ISO</sub> Output | Operation  |
|-------------------------|------------------------|--------------------------|------------------------|------------------------|-------------------------|--|
| H                       | X                      | PWM <sup>1</sup>         | H                      | 5.0 V                  | 5.0 V                   | Master mode operation, self regulating.  |
| H                       | X                      | PWM <sup>1</sup>         | L                      | 5.0 V                  | 3.3 V                   | Master mode operation, self regulating.  |
| H                       | X                      | PWM <sup>1</sup>         | H                      | 3.3 V                  | 5.0 V                   | This configuration is not recommended due to poor efficiency.  |
| H                       | X                      | PWM <sup>1</sup>         | L                      | 3.3 V                  | 3.3 V                   | Master mode operation, self regulating.  |
| L                       | RC <sub>OUT(EXT)</sub> | RC <sub>IN</sub>         | X                      | X <sup>2</sup>         | X                       | Slave mode, RC <sub>OUT(EXT)</sub> supplied by a master <i>iso</i> Power device.   |
| L                       | L                      | L                        | X                      | X                      | 0 V                     | Low power mode, converter disabled.  |
| L                       | H                      | H                        | X                      | X                      | X                       | This combination of RC <sub>IN</sub> and RC <sub>SEL</sub> is prohibited. Damage occurs on the secondary side of the converter due to excess output voltage at V <sub>ISO</sub> . RC <sub>IN</sub> must be low, or it must be connected to a PWM signal from a master <i>iso</i> Power part. |

<sup>1</sup> PWM refers to the regulation control signal. This signal is derived from the secondary side regulator or from the RC<sub>IN</sub> input, depending on the value of RC<sub>SEL</sub>.<sup>2</sup> V<sub>DD1</sub> must be common between all *iso*Power devices being regulated by a master *iso*Power part.

TYPICAL PERFORMANCE CHARACTERISTICS

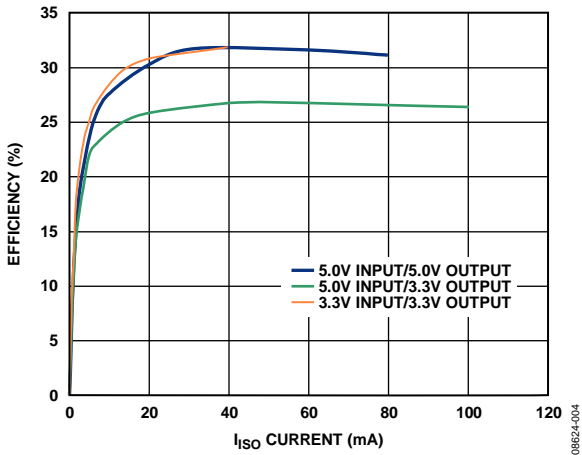

Figure 4. Typical Power Supply Efficiency in All Supported Power Configurations

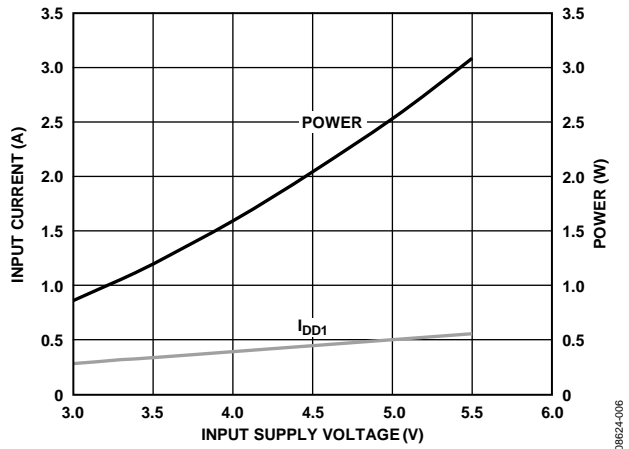

Figure 7. Typical Short-Circuit Input Current and Power vs.  $V_{DD1}$  Supply Voltage

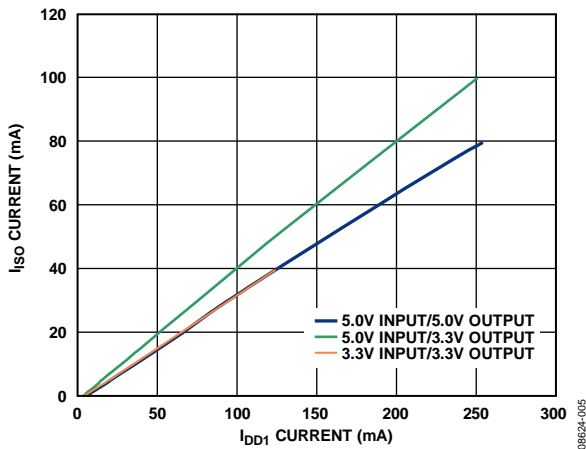

Figure 5. Typical Isolated Output Supply Current vs. Input Current in All Supported Power Configurations

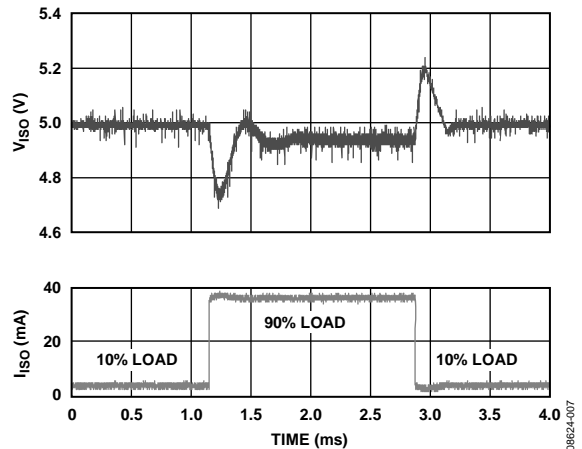

Figure 8. Typical  $V_{ISO}$  Transient Load Response, 5 V Output, 10% to 90% Load Step

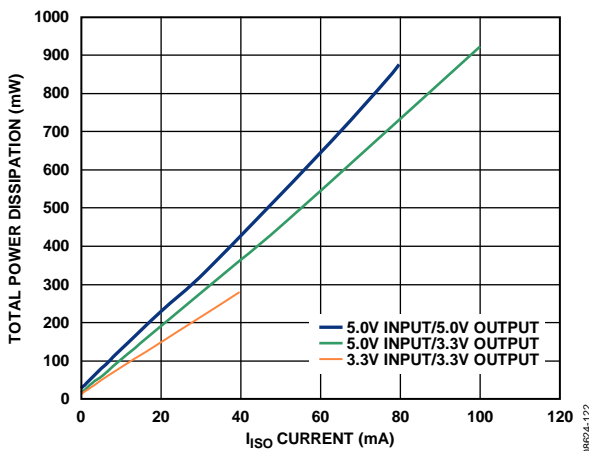

Figure 6. Typical Total Power Dissipation vs. Isolated Output Supply Current in All Supported Power Configurations

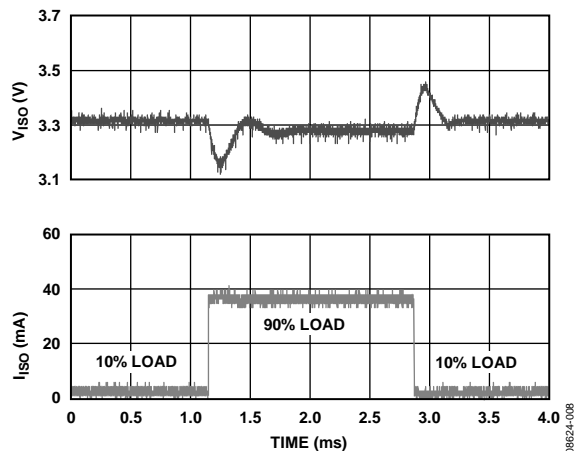

Figure 9. Typical  $V_{ISO}$  Transient Load Response, 3.3 V Output, 10% to 90% Load Step

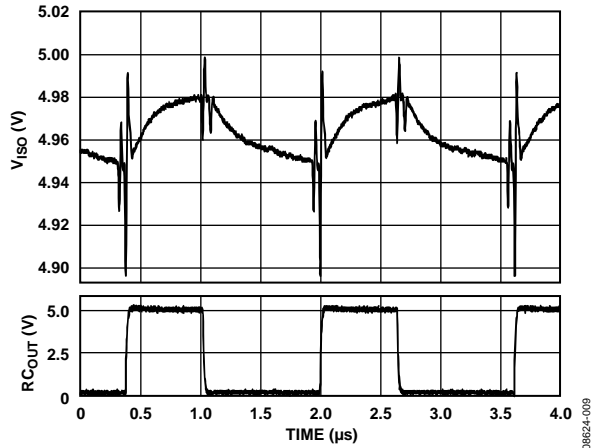

Figure 10. Typical Output Voltage Ripple at 90% Load,  $V_{ISO} = 5 V$

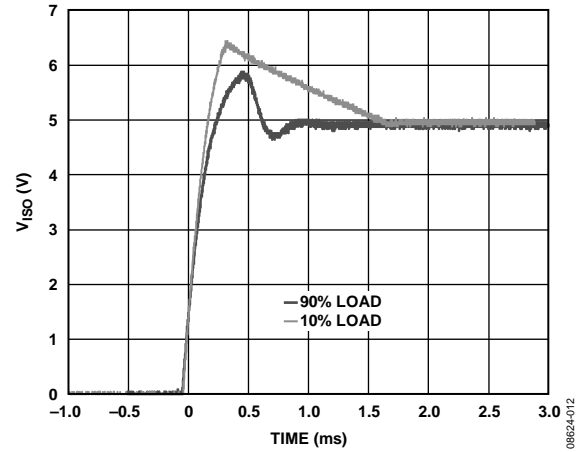

Figure 12. Typical Output Voltage Start-Up Transient at 10% and 90% Load,  $V_{ISO} = 5 V$

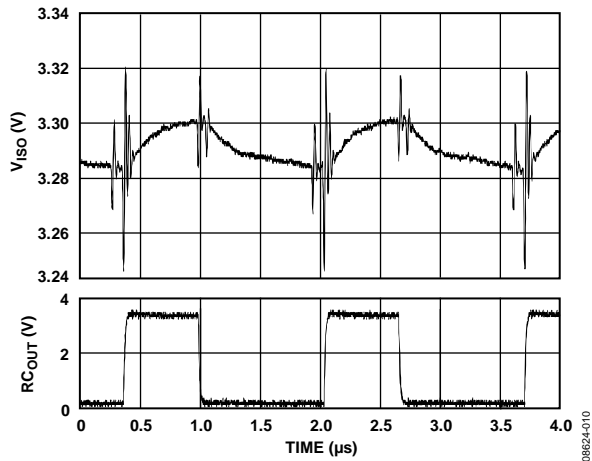

Figure 11. Typical Output Voltage Ripple at 90% Load,  $V_{ISO} = 3.3 V$

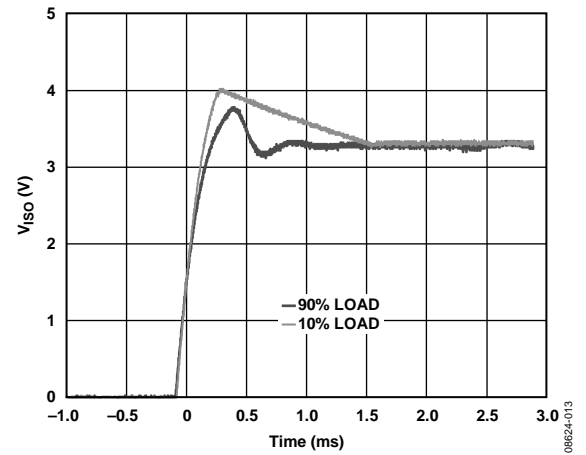

Figure 13. Typical Output Voltage Start-Up Transient at 10% and 90% Load,  $V_{ISO} = 3.3 V$

## APPLICATIONS INFORMATION

The dc-to-dc converter section of the [ADuM6000](#) works on principles that are common to most switching power supplies. It has a secondary side controller architecture with isolated pulse-width modulation (PWM) feedback.  $V_{DD1}$  power is supplied to an oscillating circuit that switches current into a chip scale air core transformer. Power transferred to the secondary side is rectified and regulated to either 3.3 V or 5 V. The secondary ( $V_{ISO}$ ) side controller regulates the output by creating a PWM control signal that is sent to the primary ( $V_{DD1}$ ) side by a dedicated *iCoupler* data channel. The PWM modulates the oscillator circuit to control the power being sent to the secondary side. Feedback allows for significantly higher power and efficiency.

The [ADuM6000](#) provides a regulation control output ( $RC_{OUT}$ ) signal that can be connected to other *isoPower* devices. This feature allows a single regulator to control multiple power modules without contention. When auxiliary power modules are present, the  $V_{ISO}$  pins can be connected together to work as a single supply. Because there is only one feedback control path, the supplies work together seamlessly. The [ADuM6000](#) can be a source of regulation control (master mode), and it can also be controlled by another *isoPower* device (slave mode).

The [ADuM6000](#) implements undervoltage lockout (UVLO) with hysteresis in the  $V_{DD1}$  input protection circuitry. When the input voltage rises above the UVLO threshold, the dc-to-dc converter becomes active. The input voltage must be decreased below the turn-on threshold by the hysteresis value to disable the converter. This feature has many benefits in the power-up sequence of the converter. For example, UVLO ensures that the system supply rises to a minimum level before the [ADuM6000](#) demands current. Also, it prevents any voltage drop due to converter current from turning the supply off and causing oscillation.

### PCB LAYOUT

The [ADuM6000](#) digital isolator is a 0.4 W *isoPower* integrated dc-to-dc converter that requires no external interface circuitry for the logic interfaces. Power supply bypassing is required at the input and output supply pins (see Figure 14).

The power supply section of the [ADuM6000](#) uses a 180 MHz oscillator frequency to pass power efficiently through its chip scale transformers. In addition, the normal operation of the data section of the *iCoupler* introduces switching transients on the power supply pins. Bypass capacitors are required for several operating frequencies. Noise suppression requires a low inductance, high frequency capacitor, whereas ripple suppression and proper regulation require a large value capacitor. These capacitors are most conveniently connected between Pin 1 and Pin 2 for  $V_{DD1}$ , and between Pin 15 and Pin 16 for  $V_{ISO}$ .

To suppress noise and reduce ripple, a parallel combination of at least two capacitors is required. The recommended capacitor values are 0.1  $\mu\text{F}$  and 10  $\mu\text{F}$ . Best practice recommends using a very low inductance ceramic capacitor, or its equivalent, for the smaller value. The total lead length between both ends of the capacitor and the input power supply pin should not exceed 10 mm. Consider bypassing between Pin 1 and Pin 8 and between Pin 9 and Pin 16 unless both common ground pins are connected together close to the package.

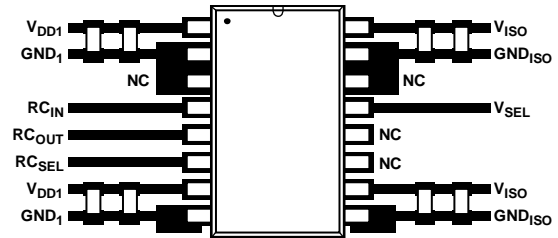

Figure 14. Recommended PCB Layout

In applications involving high common-mode transients, ensure that board coupling across the isolation barrier is minimized. Furthermore, design the board layout such that any coupling that does occur affects all pins equally on a given component side. Failure to ensure this can cause voltage differentials between pins exceeding the absolute maximum ratings for the device as specified in Table 10, thereby leading to latch-up and/or permanent damage.

The [ADuM6000](#) is a power device that dissipates approximately 1 W of power when fully loaded. Because it is not possible to apply a heat sink to an isolation device, the device primarily depends on heat dissipation into the PCB through the GND pins. If the device is used at high ambient temperatures, provide a thermal path from the GND pins to the PCB ground plane. The board layout in Figure 14 shows enlarged pads for Pin 2 and Pin 8 ( $GND_1$ ) and for Pin 9 and Pin 15 ( $GND_{ISO}$ ). Implement multiple vias from the pad to the ground plane to significantly reduce the temperature inside the chip. The dimensions of the expanded pads are at the discretion of the designer and depend on the available board space.

### START-UP BEHAVIOR

The [ADuM6000](#) device does not contain a soft start circuit. Therefore, the start-up current and voltage behavior must be taken into account when designing with this device.

When power is applied to  $V_{DD1}$ , the input switching circuit begins to operate and draw current when the UVLO minimum voltage is reached. The switching circuit drives the maximum available power to the output until it reaches the regulation voltage where PWM control begins. The amount of current and the time required to reach regulation voltage depends on the load and the  $V_{DD1}$  slew rate.

With a fast  $V_{DD1}$  slew rate (200  $\mu$ s or less), the peak current draws up to 100 mA/V of  $V_{DD1}$ . The input voltage goes high faster than the output can turn on, so the peak current is proportional to the maximum input voltage.

With a slow  $V_{DD1}$  slew rate (in the millisecond range), the input voltage is not changing quickly when  $V_{DD1}$  reaches the UVLO minimum voltage. The current surge is approximately 300 mA because  $V_{DD1}$  is nearly constant at the 2.7 V UVLO voltage. The behavior during startup is similar to when the device load is a short circuit; these values are consistent with the short-circuit current shown in Figure 7.

When starting the device for  $V_{ISO} = 5$  V operation, do not limit the current available to the  $V_{DD1}$  power pin to less than 300 mA. The ADuM6000 device may not be able to drive the output to the regulation point if a current-limiting device clamps the  $V_{DD1}$  voltage during startup. As a result, the ADuM6000 device can draw large amounts of current at low voltage for extended periods of time.

The output voltage of the ADuM6000 device exhibits  $V_{ISO}$  overshoot during startup. If this overshoot could potentially damage components attached to  $V_{ISO}$ , a voltage-limiting device such as a Zener diode can be used to clamp the voltage. Typical behavior is shown in Figure 12 and Figure 13.

## EMI CONSIDERATIONS

The dc-to-dc converter section of the ADuM6000 must operate at 180 MHz to allow efficient power transfer through the small transformers. This creates high frequency currents that can propagate in circuit board ground and power planes, causing edge emissions and dipole radiation between the primary and secondary ground planes. Grounded enclosures are recommended for applications that use these devices. If grounded enclosures are not possible, follow good RF design practices in the layout of the PCB. See the AN-0971 Application Note for board layout recommendations.

## THERMAL ANALYSIS

The ADuM6000 consists of four internal silicon die attached to a split lead frame with two die attach paddles. For the purposes of thermal analysis, it is treated as a thermal unit with the highest junction temperature reflected in the  $\theta_{JA}$  value from Table 5. The value of  $\theta_{JA}$  is based on measurements taken with the part mounted on a JEDEC standard 4-layer board with fine width traces and still air. Under normal operating conditions, the ADuM6000 operates at full load across the full temperature range without derating the output current. However, following the recommendations in the PCB Layout section decreases the thermal resistance to the PCB, allowing increased thermal margin at high ambient temperatures.

## CURRENT LIMIT AND THERMAL OVERLOAD PROTECTION

The ADuM6000 is protected against damage due to excessive power dissipation by thermal overload protection circuits. Thermal overload protection limits the junction temperature to a maximum of 150°C (typical). Under extreme conditions (that is, high ambient temperature and power dissipation), when the junction temperature starts to rise above 150°C, the PWM is turned off, turning off the output current. When the junction temperature drops below 130°C (typical), the PWM turns on again, restoring the output current to its nominal value.

Consider the case where a hard short from  $V_{ISO}$  to ground occurs. At first, the ADuM6000 reaches its maximum current, which is proportional to the voltage applied at  $V_{DD1}$ . Power dissipates on the primary side of the converter (see Figure 7). If self-heating of the junction becomes great enough to cause its temperature to rise above 150°C, thermal shutdown is activated, turning off the PWM and turning off the output current. As the junction temperature cools and drops below 130°C, the PWM turns on and power dissipates again on the primary side of the converter, causing the junction temperature to rise to 150°C again. This thermal oscillation between 130°C and 150°C causes the part to cycle on and off as long as the short remains at the output.

Thermal limit protections are intended to protect the device against accidental overload conditions. For reliable operation, externally limit device power dissipation to prevent junction temperatures from exceeding 130°C.

## POWER CONSIDERATIONS

The ADuM6000 converter primary side is protected from premature operation by undervoltage lockout (UVLO) circuitry. Below the minimum operating voltage, the power converter holds its oscillator inactive.

When the primary side oscillator begins to operate, it transfers power to the secondary power circuits. The secondary  $V_{ISO}$  voltage starts below its UVLO limit, making it inactive and unable to generate a regulation control signal. The primary side power oscillator is allowed to free run under this condition, supplying the maximum amount of power to the secondary side.

As the secondary side voltage rises to its regulation setpoint, a large inrush current transient is present at  $V_{DD1}$ . When the regulation point is reached, the regulation control circuit produces the regulation control signal that modulates the oscillator on the primary side. The  $V_{DD1}$  current is then reduced and is proportional to the load current. The inrush current is less than the short-circuit current shown in Figure 7. The duration of the inrush current depends on the  $V_{ISO}$  loading conditions and on the current and voltage available at the  $V_{DD1}$  pin.

## INCREASING AVAILABLE POWER

The ADuM6000 device is designed to work in combination with other compatible *isoPower* devices. The RC<sub>OUT</sub>, RC<sub>IN</sub>, and RC<sub>SEL</sub> pins allow the ADuM6000 to provide its PWM signal to another device through its RC<sub>OUT</sub> pin, acting as a master. It can also receive a PWM signal from another device through its RC<sub>IN</sub> pin and act as a slave to that control signal. The RC<sub>SEL</sub> pin chooses whether the part acts as a master or slave device.

When the ADuM6000 acts as a slave, its power is regulated by the master device, allowing multiple *isoPower* parts to be combined in parallel while sharing the load equally. When the ADuM6000 is configured as a master or standalone device, it generates its own PWM feedback signal to regulate itself and any slave devices.

The ADuM6000 can function as a master, slave, or standalone device. All devices in the ADuM5xxx and ADuM6xxx family can function as standalone devices. Some of these devices also function as master devices or slave devices, but not both (see Table 14).

Table 15 illustrates how *isoPower* devices can provide many combinations of data channel count and multiples of the single-unit power.

Table 14. Function of *isoPower* Parts

| Part No.             | Function |       |            |
|----------------------|----------|-------|------------|
|                      | Master   | Slave | Standalone |
| ADuM6000             | Yes      | Yes   | Yes        |
| ADuM620x             | No       | Yes   | Yes        |
| ADuM640x             | No       | No    | Yes        |
| ADuM5000             | Yes      | Yes   | Yes        |
| ADuM520x             | No       | Yes   | Yes        |
| ADuM5400             | No       | No    | Yes        |
| ADuM5401 to ADuM5404 | Yes      | No    | Yes        |

Another feature that is allowed by the RC<sub>SEL</sub> and RC<sub>IN</sub> control architecture is the ability to completely shut down the oscillator in the dc-to-dc converter. This places the part in a low power standby mode and reduces the current draw to a fraction of a milliamp.

When the ADuM6000 is placed in slave mode by driving RC<sub>SEL</sub> low, the oscillator is controlled by RC<sub>IN</sub>. If RC<sub>IN</sub> is held low, the oscillator is shut down and the part is in low power standby mode. With no oscillator driving power to the secondary side, V<sub>ISO</sub> turns off. This mode is useful for applications where an isolated subsystem may be shut down to conserve power. To reactivate the power module, drive RC<sub>SEL</sub> high; the power supply resumes operation.

Table 15. Configurations for Power and Data Channels

| Power Units         | Number of Data Channels   |   |   |
|---------------------|---|---|---|
|                     | 0 Channels  | 2 Channels  | 4 Channels  |
| <b>1-Unit Power</b> | ADuM6000 or ADuM5000 (standalone)   | ADuM620x or ADuM520x (standalone)   | ADuM5401, ADuM5402, ADuM5403, ADuM5404, or ADuM640x (standalone)                              |
| <b>2-Unit Power</b> | ADuM6000 or ADuM5000 (master)<br>ADuM6000 or ADuM5000 (slave)                                 | ADuM6000 or ADuM5000 (master)<br>ADuM620x or ADuM520x (slave)                                 | ADuM5401, ADuM5402, ADuM5403, ADuM5404 (master)<br>ADuM6000 or ADuM5000 (slave)               |
| <b>3-Unit Power</b> | ADuM6000 or ADuM5000 (master)<br>ADuM6000 or ADuM5000 (slave)<br>ADuM6000 or ADuM5000 (slave) | ADuM6000 or ADuM5000 (master)<br>ADuM6000 or ADuM5000 (slave)<br>ADuM620x or ADuM520x (slave) | ADuM6000 or ADuM5000 (master)<br>ADuM620x or ADuM520x (slave)<br>ADuM620x or ADuM520x (slave) |

## INSULATION LIFETIME

All insulation structures eventually break down when subjected to voltage stress over a sufficiently long period. The rate of insulation degradation is dependent on the characteristics of the voltage waveform applied across the insulation. In addition to the testing performed by the regulatory agencies, Analog Devices carries out an extensive set of evaluations to determine the lifetime of the insulation structure within the ADuM6000.

Analog Devices performs accelerated life testing using voltage levels higher than the rated continuous working voltage. Acceleration factors for several operating conditions are determined. These factors allow calculation of the time to failure at the actual working voltage. The values shown in Table 11 summarize the peak voltage for 50 years of service life for a bipolar ac operating condition and the maximum CSA/VDE approved working voltages. In many cases, the approved working voltage is higher than the 50-year service life voltage. Operation at these high working voltages can lead to shortened insulation life in some cases.

The insulation lifetime of the ADuM6000 depends on the voltage waveform imposed across the isolation barrier. The iCoupler insulation structure degrades at different rates depending on whether the waveform is bipolar ac, unipolar ac, or dc. Figure 15, Figure 16, and Figure 17 illustrate these different isolation voltage waveforms.

Bipolar ac voltage is the most stringent environment. The goal of a 50-year operating lifetime under the bipolar ac condition determines the maximum working voltage recommended by Analog Devices.

In the case of unipolar ac or dc voltage, the stress on the insulation is significantly lower. This allows operation at higher working voltages while still achieving a 50-year service life. The working voltages listed in Table 11 can be applied while maintaining the 50-year minimum lifetime, provided that the voltage conforms to either the unipolar ac or dc voltage cases.

Any cross-insulation voltage waveform that does not conform to Figure 16 or Figure 17 should be treated as a bipolar ac waveform and its peak voltage limited to the 50-year lifetime voltage value listed in Table 11. The voltage presented in Figure 16 is shown as sinusoidal for illustration purposes only. It is meant to represent any voltage waveform varying between 0 V and some limiting value. The limiting value can be positive or negative, but the voltage cannot cross 0 V.

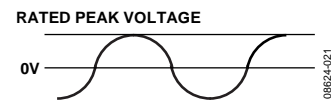

Figure 15. Bipolar AC Waveform

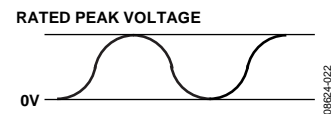

Figure 16. Unipolar AC Waveform

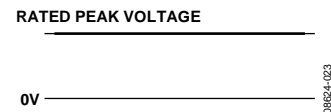
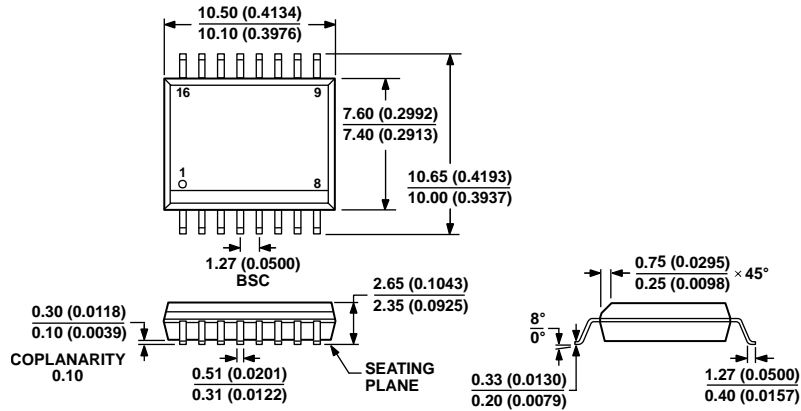

Figure 17. DC Waveform

OUTLINE DIMENSIONS



COMPLIANT TO JEDEC STANDARDS MS-013-AA  
 CONTROLLING DIMENSIONS ARE IN MILLIMETERS; INCH DIMENSIONS  
 (IN PARENTHESES) ARE ROUNDED-OFF MILLIMETER EQUIVALENTS FOR  
 REFERENCE ONLY AND ARE NOT APPROPRIATE FOR USE IN DESIGN.

Figure 18. 16-Lead Standard Small Outline Package [SOIC\_W]  
 Wide Body  
 (RW-16)  
 Dimensions shown in millimeters and (inches)

03-27-2007-B

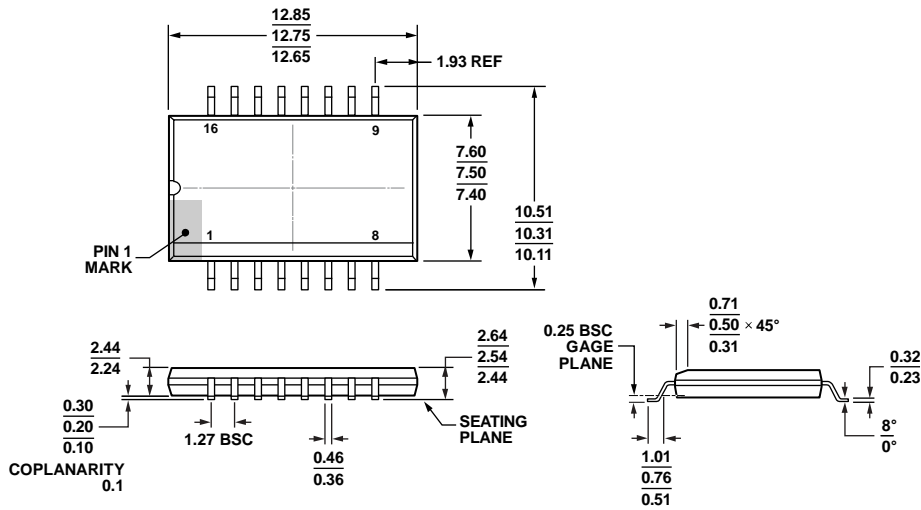

COMPLIANT TO JEDEC STANDARDS MS-013-AC

Figure 19. 16-Lead Standard Small Outline Package, with Increased Creepage [SOIC\_IC]  
 Wide Body  
 (RI-16-2)  
 Dimensions shown in millimeters

11-15-2011-A

ORDERING GUIDE

| Model <sup>1</sup> | Temperature Range | Package Description <sup>2</sup> | Package Option |
|--------------------|-------------------|----------------------------------|----------------|
| ADuM6000ARWZ       | -40°C to +105°C   | 16-Lead SOIC_W                   | RW-16          |
| ADuM6000ARIZ       | -40°C to +105°C   | 16-Lead SOIC_IC                  | RI-16-2        |

<sup>1</sup> Z = RoHS Compliant Part.

<sup>2</sup> Tape and reel are available. The additional -RL suffix designates a 13-inch (1,000 units) tape and reel option.