

Features

- RoHS compliant*
- Space saving design
- Wide range of resistance values
- PC pin or solder lug terminals
- Metric shaft and bushing option
- Mounting brackets available

PC - "Slimline" 22 mm Square Single-Turn Panel Control

Electrical Characteristics¹

Standard Resistance Range	
Linear Tapers	500 ohms to 1 megohm
Audio Tapers	1 K ohms to 500 K ohms
Total Resistance Tolerance	±20 %
Independent Linearity	±5 %
Absolute Minimum Resistance	5 ohms maximum
Effective Electrical Angle	270 ° ± 5 °
Contact Resistance Variation	7 % of total resistance
Dielectric Withstanding Voltage (MIL-STD-202, Method 301)	
Sea Level	1,000 VAC minimum
70,000 Feet	500 VAC minimum
Insulation Resistance (500 V)	1,000 ohms minimum
Power Rating @ 70 °C (Voltage Limited by Power Dissipation or 350 VAC, Whichever is Less)	
Linear75 watt
Audio25 watt
Theoretical Resolution	Essentially infinite

Environmental Characteristics

Operating Temperature Range	+1 °C to +125 °C
Storage Temperature Range	-40 °C to +125 °C
Temperature Coefficient Over Storage Temperature Range	±1000 ppm/°C
Vibration20 G
Total Resistance Shift	±1 % maximum
Voltage Ratio Shift	±20 % maximum
Shock50 G
Total Resistance Shift	±1 % maximum
Voltage Ratio Shift	±20 % maximum
Load Life	1,000 Hours @ Rated Power, 20 % RH, 70 °C
Total Resistance Shift	±10 % maximum
Rotational Life (No Load)	50,000 cycles
Total Resistance Shift (Linear taper)	±10 ohms or 12 %, whichever is greater
Total Resistance Shift (Audio taper)	±20 % maximum
Contact Resistance Variation	±5 % maximum
Moisture Resistance	MIL-STD-202, Method 103, Condition B
Total Resistance Shift	±20 % maximum
IP Rating	IP 40

Mechanical Characteristics

Stop Strength (1/4" and 6 mm Shaft Diameters)	79.09 N-cm (7 lb.-in.)
Mechanical Angle	300 ° ± 5 °
Torque	
Starting (Detented)	0.5-1.5 N-cm (0.75-2.25 oz.-in.)
Starting (Undetented)	1.5 N-cm (2.25 oz.-in.) maximum
Running (Undetented)	0.18 to 1.06 N-cm (0.25 to 1.5 oz.-in.)
Mounting	79.09 N-cm (7 lb.-in.) maximum
Weight (Single Section)	21 gm (0.75 oz.) maximum
Terminals	PC pin or solder lug
Soldering Condition	
Manual Soldering	96.5Sn/3.0Ag/0.5Cu solid wire or no-clean rosin cored wire 370 °C (700 °F) max. for 3 seconds
Wave Soldering	96.5Sn/3.0Ag/0.5Cu solder with no-clean flux 260 °C (500 °F) max. for 5 seconds
Wash processes	Not recommended
Marking	Manufacturer's trademark, resistance value, part number, and date code
Ganging	1 cup maximum
Hardware	One lockwasher (H-37-2) and one mounting nut (H-38-11) is shipped with each potentiometer
Detents	Center, 10, 20, 30, none

For additional features or specifications not shown, consult factory.

FOR ORDERING INFORMATION SEE PAGE 4.

¹ Electrical specifications tested at 200 RPM, at room ambient: +25 °C nominal.

*RoHS Directive 2015/863, Mar 31, 2015 and Annex.

Specifications are subject to change without notice. Users should verify actual device performance in their specific applications. The products described herein and this document are subject to specific legal disclaimers as set forth on the last page of this document, and at www.bourns.com/docs/legal/disclaimer.pdf.



WARNING
Cancer and Reproductive Harm
www.P65Warnings.ca.gov

PC – “Slimline” 22 mm Square Single-Turn Panel Control

BOURNS®

Product Dimensions

Axial PC Pins

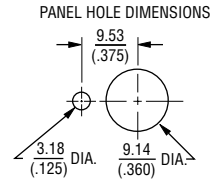
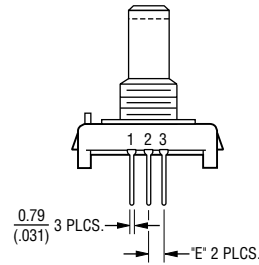
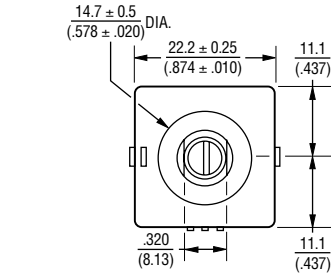
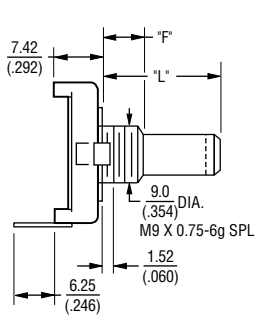

$$F' = \frac{6.35}{(.250)} \text{ OR } \frac{9.53}{(.375)}$$

$$E' = \frac{2.54}{(.100)} \text{ OR } \frac{5.08}{(.200)}$$

L = SEE SHAFT LENGTH TABLE

Radial PC Pins

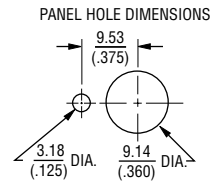
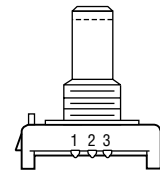
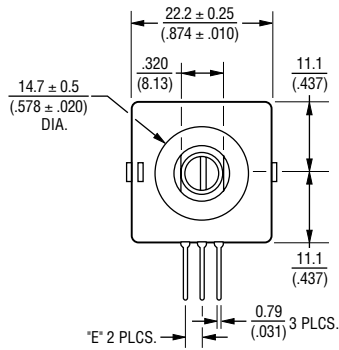
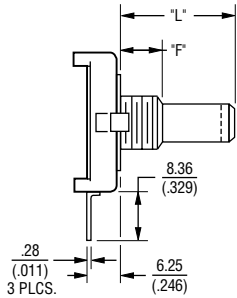

$$F' = \frac{6.35}{(.250)} \text{ OR } \frac{9.53}{(.375)}$$

$$E' = \frac{2.54}{(.100)} \text{ OR } \frac{5.08}{(.200)}$$

L = SEE SHAFT LENGTH TABLE

DIMENSIONS: $\frac{\text{MM}}{\text{(INCHES)}}$

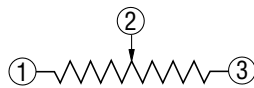

TOLERANCES EXCEPT WHERE NOTED:

$$.XX = \pm \frac{.25}{(.010)}$$

$$.XXX = \pm \frac{.13}{(.005)}$$

Hardware

LOCKWASHER H-37-2

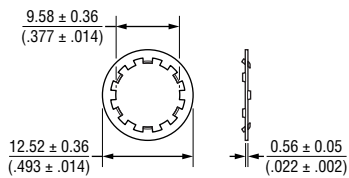

NUT H-38-11

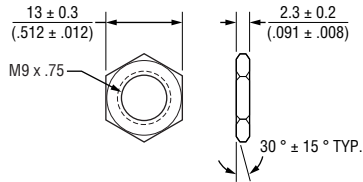

DIMENSIONS: $\frac{\text{MM}}{\text{(INCHES)}}$

Date Code Description

YYWWMM

- M = COUNTRY OF MANUFACTURE (MEXICO)
- WW = WEEK NUMBER
- YY = LAST TWO DIGITS OF YEAR MANUFACTURED

Specifications are subject to change without notice.

Users should verify actual device performance in their specific applications.

The products described herein and this document are subject to specific legal disclaimers as set forth on the last page of this document, and at www.bourns.com/docs/legal/disclaimer.pdf.

PC – “Slimline” 22 mm Square Single-Turn Panel Control

BOURNS®

Product Dimensions

SOLDER LUGS

(Dimensions not given are the same as Axial PC pins.)

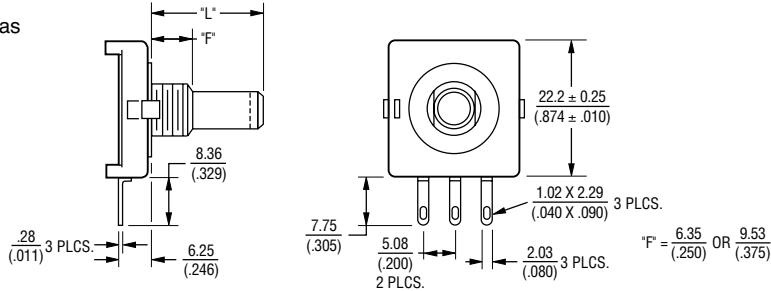

Axial PC PINS With Rear Mounting Bracket

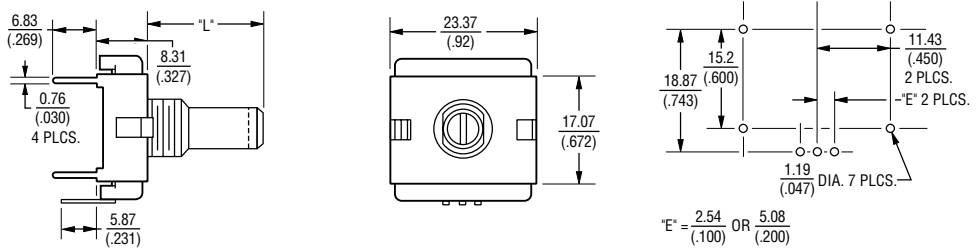

Radial PC PINS With Side Mounting Bracket

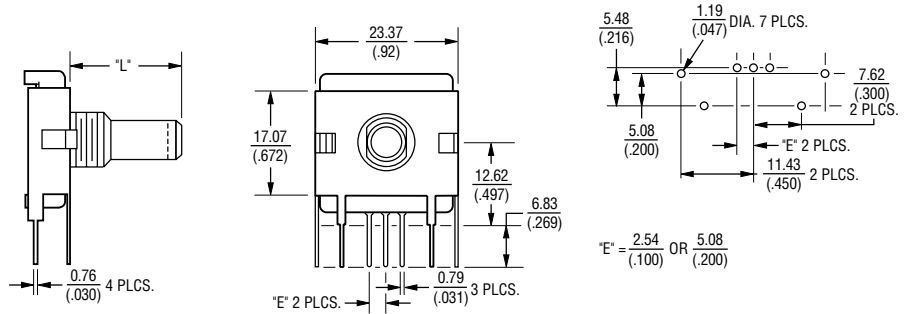

SHAFT STYLES AND ORIENTATION (Full CCW Rotation)

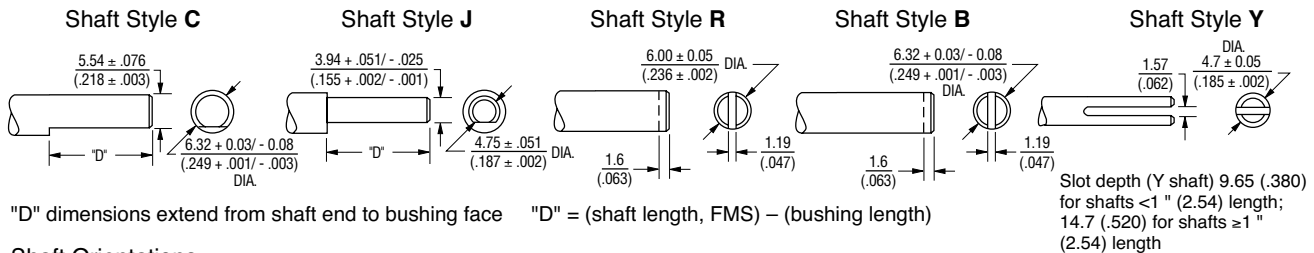

"D" dimensions extend from shaft end to bushing face "D" = (shaft length, FMS) – (bushing length)

Shaft Orientations

Shaft Styles C, J

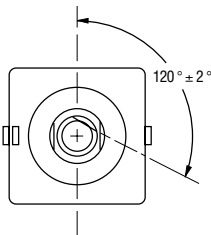

Shaft Styles B, R

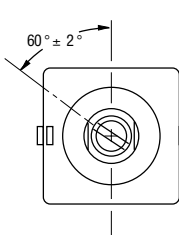

Shaft Style Y

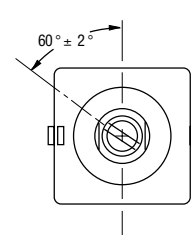

DIMENSIONS: $\frac{\text{MM}}{\text{(INCHES)}}$

TOLERANCES EXCEPT WHERE NOTED:

.XX ± $\frac{.25}{(.010)}$
 .XXX ± $\frac{.13}{(.005)}$

Specifications are subject to change without notice.

Users should verify actual device performance in their specific applications.

The products described herein and this document are subject to specific legal disclaimers as set forth on the last page of this document, and at www.bourns.com/docs/legal/disclaimer.pdf.

How to Order PC "Slimline" Panel Controls

BOURNS®

P C W 1 J - B 2 4 - B A B 1 0 3 L

RoHS IDENTIFIER	
Code	Description
L	Compliant

SHAFT LENGTH (FMS)		
Code	Description	Available Shaft Styles
16	1/2 " (12.7 mm) Length	B
20	5/8 " (15.9 mm) Length	J
24	3/4 " (19 mm) Length	B, C, J, Y
28	7/8 " (22.2 mm) Length	B, C, J, Y
32	1 " (25.4 mm) Length	B, C, J, Y
36	1-1/8 " (28.6 mm) Length	B, C, J, Y
Metric		
19	19 mm Length	R
22	22 mm Length	R
24	24 mm Length	R

RESISTANCE VALUES					
Code	TR	Code	TR	Code	TR
501	500 Ω	103	10 KΩ	104	100 KΩ
102	1 KΩ	203	20 KΩ	254	250 KΩ
252	2.5 KΩ	253	25 KΩ	504	500 KΩ
502	5 KΩ	503	50 KΩ	105	1 MΩ

ELEMENT TAPER VERSIONS	
Code	Taper Description
B	Lin. CP ±20 %
D	CW Audio CP ±20 %
G	CCW Audio CP ±20 %

SHAFT STYLES (See Outline Drawing)	
Code	Description
B	1/4 " (6.35 mm) Dia. Slotted
C	1/4 " (6.35 mm) Dia. Flatted
J	3/16 " (4.76 mm) Dia. Flatted
R	6 mm Dia. Slotted (Use Metric Lengths Only)
Y	3/16 " (4.76 mm) Dia. Split Shaft

DETENT CONFIGURATIONS	
Code	Taper Description
A	No Detents
B	10 Detents
C	Center Detent Only
D	20 Detents
E	30 Detents
F	CCW Detent Only

ANTI-ROTATION LUG	
Code	Description
J	9:00 Position
D	None

NO. SECTIONS	
Code	Description
1	Single

Features	HOUSING TERMINAL CONFIGURATION												
	Code												
	A	B	C	D	E	F	G	H	J	K	L	M	N
Rear Mounting Bracket		X							X	X		X	X
Side Mounting Bracket					X			X			X	X	
Axial Terminals .100 " (2.54 mm) Centers	X	X									X		
Radial Terminals .100 " (2.54 mm) Centers				X	X							X	
Radial Terminals .200 " (5.08 mm) Centers						X	X						X
Solder Lugs .200" (5.08 mm) Centers			X										
Axial Terminals .200 " (5.08 mm) Centers								X	X				X
Hardware Included	X	X	X	X	X	X	X	X	X	X	X	X	X

BUSHING CONFIGURATION		
Code	Description	Available Shaft Styles
W	9 mm x .250 " (6.35 mm) Length Threaded M9 x 0.75 6g 5 Pl	All
L	9 mm x .375 " (9.53 mm) Length Threaded M9 x 0.75 6g 5 Pl	B, C, R

Panel mount hardware not included as standard on bracketed versions. The sample part number demonstrates the identification code for Bourns Slimline Potentiometers. The part number shown is a commonly used model, typically available from stock.

Boldface features are Bourns standard options. All others are available with higher minimum order quantities.

BOURNS®

Asia-Pacific: Tel: +886-2 2562-4117 • Email: asiacus@bourns.com

EMEA: Tel: +36 88 885 877 • Email: eurocus@bourns.com

The Americas: Tel: +1-951 781-5500 • Email: americus@bourns.com

www.bourns.com

REV. 10/20

Specifications are subject to change without notice.

Users should verify actual device performance in their specific applications.

The products described herein and this document are subject to specific legal disclaimers as set forth on the last page of this document, and at www.bourns.com/docs/legal/disclaimer.pdf.

This legal disclaimer applies to purchasers and users of Bourns® products manufactured by or on behalf of Bourns, Inc. and its affiliates (collectively, “Bourns”).

Unless otherwise expressly indicated in writing, Bourns® products and data sheets relating thereto are subject to change without notice. Users should check for and obtain the latest relevant information and verify that such information is current and complete before placing orders for Bourns® products.

The characteristics and parameters of a Bourns® product set forth in its data sheet are based on laboratory conditions, and statements regarding the suitability of products for certain types of applications are based on Bourns’ knowledge of typical requirements in generic applications. The characteristics and parameters of a Bourns® product in a user application may vary from the data sheet characteristics and parameters due to (i) the combination of the Bourns® product with other components in the user’s application, or (ii) the environment of the user application itself. The characteristics and parameters of a Bourns® product also can and do vary in different applications and actual performance may vary over time. Users should always verify the actual performance of the Bourns® product in their specific devices and applications, and make their own independent judgments regarding the amount of additional test margin to design into their device or application to compensate for differences between laboratory and real world conditions.

Unless Bourns has explicitly designated an individual Bourns® product as meeting the requirements of a particular industry standard (e.g., ISO/TS 16949) or a particular qualification (e.g., UL listed or recognized), Bourns is not responsible for any failure of an individual Bourns® product to meet the requirements of such industry standard or particular qualification. Users of Bourns® products are responsible for ensuring compliance with safety-related requirements and standards applicable to their devices or applications.

Bourns® products are not recommended, authorized or intended for use in nuclear, lifesaving, life-critical or life-sustaining applications, nor in any other applications where failure or malfunction may result in personal injury, death, or severe property or environmental damage. Unless expressly and specifically approved in writing by two authorized Bourns representatives on a case-by-case basis, use of any Bourns® products in such unauthorized applications might not be safe and thus is at the user’s sole risk. Life-critical applications include devices identified by the U.S. Food and Drug Administration as Class III devices and generally equivalent classifications outside of the United States.

Bourns expressly identifies those Bourns® standard products that are suitable for use in automotive applications on such products’ data sheets in the section entitled “Applications.” Unless expressly and specifically approved in writing by two authorized Bourns representatives on a case-by-case basis, use of any other Bourns® standard products in an automotive application might not be safe and thus is not recommended, authorized or intended and is at the user’s sole risk. If Bourns expressly identifies a sub-category of automotive application in the data sheet for its standard products (such as infotainment or lighting), such identification means that Bourns has reviewed its standard product and has determined that if such Bourns® standard product is considered for potential use in automotive applications, it should only be used in such sub-category of automotive applications. Any reference to Bourns® standard product in the data sheet as compliant with the AEC-Q standard or “automotive grade” does not by itself mean that Bourns has approved such product for use in an automotive application.

Bourns® standard products are not tested to comply with United States Federal Aviation Administration standards generally or any other generally equivalent governmental organization standard applicable to products designed or manufactured for use in aircraft or space applications. Bourns expressly identifies Bourns® standard products that are suitable for use in aircraft or space applications on such products’ data sheets in the section entitled “Applications.” Unless expressly and specifically approved in writing by two authorized Bourns representatives on a case-by-case basis, use of any other Bourns® standard product in an aircraft or space application might not be safe and thus is not recommended, authorized or intended and is at the user’s sole risk.

The use and level of testing applicable to Bourns® custom products shall be negotiated on a case-by-case basis by Bourns and the user for which such Bourns® custom products are specially designed. Absent a written agreement between Bourns and the user regarding the use and level of such testing, the above provisions applicable to Bourns® standard products shall also apply to such Bourns® custom products.

Users shall not sell, transfer, export or re-export any Bourns® products or technology for use in activities which involve the design, development, production, use or stockpiling of nuclear, chemical or biological weapons or missiles, nor shall they use Bourns® products or technology in any facility which engages in activities relating to such devices. The foregoing restrictions apply to all uses and applications that violate national or international prohibitions, including embargos or international regulations. Further, Bourns® products and Bourns technology and technical data may not under any circumstance be exported or re-exported to countries subject to international sanctions or embargoes. Bourns® products may not, without prior authorization from Bourns and/or the U.S. Government, be resold, transferred, or re-exported to any party not eligible to receive U.S. commodities, software, and technical data.

To the maximum extent permitted by applicable law, Bourns disclaims (i) any and all liability for special, punitive, consequential, incidental or indirect damages or lost revenues or lost profits, and (ii) any and all implied warranties, including implied warranties of fitness for particular purpose, non-infringement and merchantability.

For your convenience, copies of this Legal Disclaimer Notice with German, Spanish, Japanese, Traditional Chinese and Simplified Chinese bilingual versions are available at:

Web Page: <http://www.bourns.com/legal/disclaimers-terms-and-policies>

PDF: <http://www.bourns.com/docs/Legal/disclaimer.pdf>

Mouser Electronics

Authorized Distributor

Click to View Pricing, Inventory, Delivery & Lifecycle Information:

Bourns:

[PCW1D-C24-BAB503](#) [PCW1D-R19-BAB103](#) [PCW1J-J20-DAD104](#) [PCW1J-B24-AEB103](#) [PCW1D-C24-BAB501](#)
[PCW1D-C24-BAB502](#) [PCW1J-B24-AEB501](#) [PCW1J-B24-AEB503](#) [PCW1J-B24-CCB103](#) [PCW1J-B24-CCB104](#)
[PCW1J-B24-CCB102](#) [PCW1J-B28-CCB103](#) [PCW1J-B36-BAB254](#) [PCW1J-B24-BAB203](#) [PCW1D-B24-CEB105](#)
[PCW1J-J20-BAB103](#) [PCL1D-B24-KDB102](#) [PCW1J-C24-AAD502](#) [PCW1D-B16-MAB753](#) [PCW1D-B24-FAB103](#)
[PCW1J-B24-BAB104](#) [PCW1J-B24-BAB105](#) [PCW1J-B24-BAB103](#) [PCW1D-B24-BCD103](#) [PCW1J-B36-BAB503](#)
[PCW1J-B28-BAB102](#) [PCW1J-B24-BAB102](#) [PCW1J-B28-BAB104](#) [PCL1D-B24-CAB103](#) [PCW1J-B28-BAB103](#)
[PCW1J-B16-BAD103](#) [PCW1J-J20-EAB103](#) [PCW1D-B16-KAB502](#) [PCW1D-C24-GAB103](#) [PCW1J-C24-KAB103](#)
[PCW1D-C24-KAB254](#) [PCW1J-C28-KAB103](#) [PCW1J-C28-KAB102](#) [PCW1D-B24-BAD502](#) [PCW1J-C24-KAB104](#)
[PCW1J-B24-KAB502](#) [PCW1J-B28-KAB502](#) [PCW1J-B28-JCB103](#) [PCW1J-R24-CAB503](#) [PCW1D-J20-FAB104](#)
[PCW1J-C24-BAB504](#) [PCW1J-C24-BAB503](#) [PCW1J-C24-BAB502](#) [PCW1J-C28-BAB503](#) [PCW1J-C28-BAB502](#)
[PCW1J-C36-BAB103](#) [PCW1J-C32-BAB103](#) [PCW1J-B24-CAD254](#) [PCW1J-B24-CAD203](#) [PCW1J-B28-BAB503](#)
[PCW1J-B24-BAB502](#) [PCW1J-B28-BAB502](#) [PCL1J-B28-BAB504](#) [PCW1J-R24-BBB502](#) [PCW1J-B32-BAB103](#)
[PCW1J-B24-BAB504](#) [PCL1J-B24-BAB503](#) [PCW1J-B24-BAB503](#) [PCW1J-R24-LAB103](#) [PCW1D-B32-BCB102](#)
[PCW1D-B24-BCB502](#) [PCW1J-B24-BCD103](#) [PCW1D-C24-BEB105](#) [PCW1J-R24-CAB102](#) [PCW1J-R24-CAB104](#)
[PCW1J-R24-CAB103](#) [PCW1D-B24-CAB502](#) [PCW1D-B24-BAB103](#) [PCW1D-B28-BAB103](#) [PCW1D-B24-BAB104](#)
[PCW1D-B24-BAB102](#) [PCW1D-B32-BAB502](#) [PCW1D-B24-EAD103](#) [PCW1D-C24-BAB254](#) [PCW1J-C28-BAB102](#)
[PCW1J-C28-BAB103](#) [PCW1J-C28-BAB104](#) [PCW1J-R24-BCB103](#) [PCW1J-C24-DAB102](#) [PCW1D-R24-BAB252](#)
[PCW1D-B24-EAB501](#) [PCL1D-R24-KAB252](#) [PCW1D-R24-KAB252](#) [PCW1J-B24-KBB103](#) [PCW1J-B24-CAB104](#)
[PCW1J-B36-CAB502](#) [PCW1J-B24-CAB102](#) [PCW1J-B24-CAB103](#) [PCW1D-R19-EAB502](#) [PCW1J-C24-CAB252](#)
[PCW1J-C28-CAB254](#) [PCW1J-B28-CEB105](#) [PCW1J-C24-BCB502](#) [PCW1J-B24-CEB104](#) [PCW1J-C24-CAB503](#)