

# Solid-State Relays

Panel Mount Package—VDC Input / VAC Output  
OSSRD0001A thru OSSRD0006A



## Features:

- Molded Epoxy package
- Zero crossing circuit
- High Input/output Optical Isolation 4k Vrms
- Superior heat sink package
- Includes LED indicator
- Fast switching time
- Non-contact switch
- UL Certification No: E321810



## Description:

The OSSR Solid State Relay series are electronic controlled switches, they contain no moving parts. When voltage is applied to the input, a Light Emitting Diode or LED illuminates a Photosensor which controls the internal output circuit. The output circuit is utilized to drive high current loads. The input and output are optically isolated. The OSSR series incorporates a zero crossing circuit which minimizes current and noise surges due to resistive and inductive loads. Optek provides three different electrical configurations of the OSSR series: DC input – AC output, AC input – AC output and DC input – DC output. These configurations meet most industry applications.

The **OSSRD000XA** family comes in a standard panel mount package, commonly known as a “hockey puck” package. The package offers a robust molded epoxy body with exceptional thermal dissipation capability for a long reliable operational life. The input circuit features a DC range from 4 to 32 VDC. The output consists of a Triac circuit featuring load current ratings from 10 to 40 Amps and maximum load voltages from 250 to 480VAC with normally open output.

Protective plastic covers are included with shipment of OSSRD series.  
Installation of the protection cover is necessary.

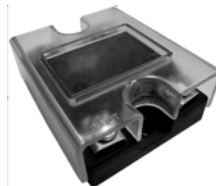

## Applications:

- Temperature controlled systems
- Office equipment
- Motor controls
- Industrial Equipment
- Light controls systems
- Heater control
- Appliances
- HVAC temperature control
- Plastic molding
- Packaging industry
- Food processing temperature controls



Moisture

OPTEK reserves the right to make changes at any time in order to improve design and to supply the best product possible.

# Solid-State Relays

Panel Mount Package—VDC Input / VAC Output  
OSSRD0001A thru OSSRD0006A



Package Outline Dimensions: Panel Mount

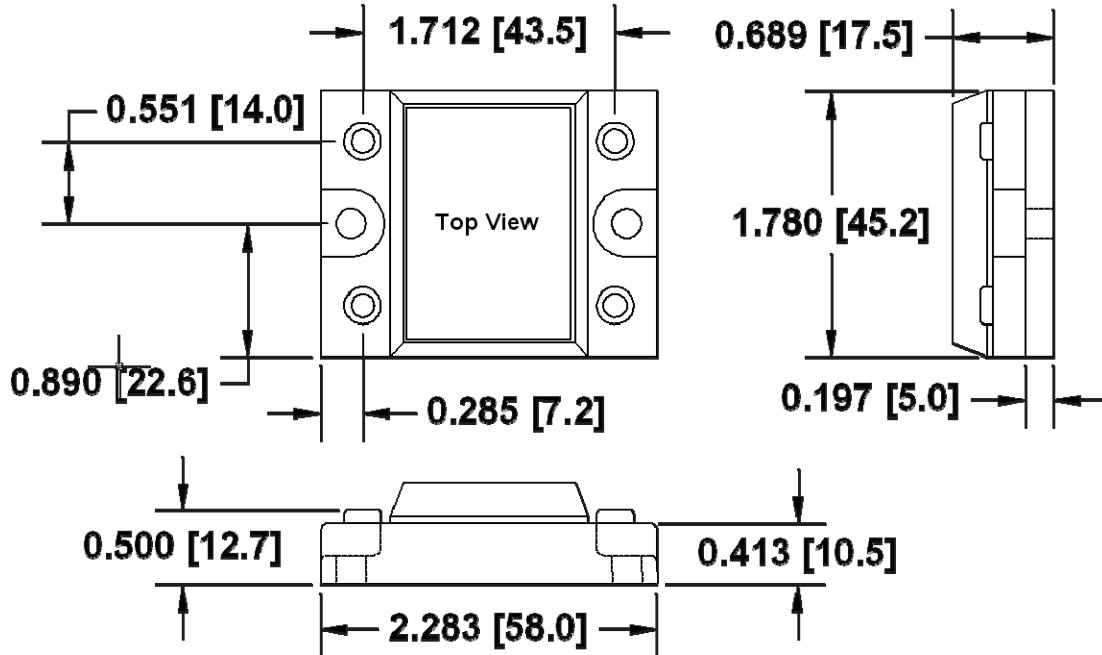

All dimensions in: inches [millimeters]  
Tolerance: ±0.004 inches [0.10 millimeters]

Schematic: Top View

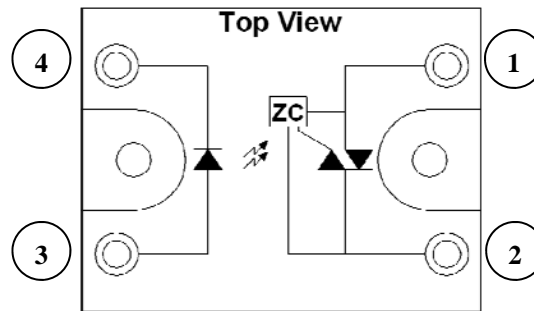

OSSRD0001A—OSSRD0006A

## Pin Configuration

Part Number	Pin #			
	1	2	3	4
OSSRD0001A	A (-)	A (+)	A	K
OSSRD0002A	A (-)	A (+)	A	K
OSSRD0003A	A (-)	A (+)	A	K
OSSRD0004A	A (-)	A (+)	A	K
OSSRD0005A	A (-)	A (+)	A	K
OSSRD0006A	A (-)	A (+)	A	K

OPTEK reserves the right to make changes at any time in order to improve design and to supply the best product possible.

# Solid-State Relays

Panel Mount Package—VDC Input / VAC Output  
OSSRD0001A thru OSSRD0006A



## VDC Input / VAC Output Devices Ordering Information

Part Number	Input	Min. Tgr Current I <sub>ft</sub>	Max. Output Current	Min. Ouput Current	Max. Vout	Min. Vout	Output Type	Br. Vol. Input to Output	Configuration
OSSRD0001A	4-32VDC	5mA	10A	0.05A	250VAC	50VAC	AC	4000VAC	A K—A1(+) A2(-)
OSSRD0002A	4-32VDC	5mA	15A	0.05A	250VAC	50VAC	AC	4000VAC	A K—A1(+) A2(-)
OSSRD0003A	4-32VDC	5mA	25A	0.05A	250VAC	50VAC	AC	4000VAC	A K—A1(+) A2(-)
OSSRD0004A	4-32VDC	5mA	40A	0.05A	250VAC	75VAC	AC	4000VAC	A K—A1(+) A2(-)
OSSRD0005A	4-32VDC	5mA	25A	0.05A	480VAC	75VAC	AC	4000VAC	A K—A1(+) A2(-)
OSSRD0006A	4-32VDC	5mA	40A	0.05A	480VAC	75VAC	AC	4000VAC	A K—A1(+) A2(-)

Configuration: Definition of Terms  
LED Identification—Sensor Identification

Configuration Information	LED	A = Anode	K = Cathode
	Sensor	A1(+) and A2(-) = Main Terminals of Triac	

## Part Number Symbolization

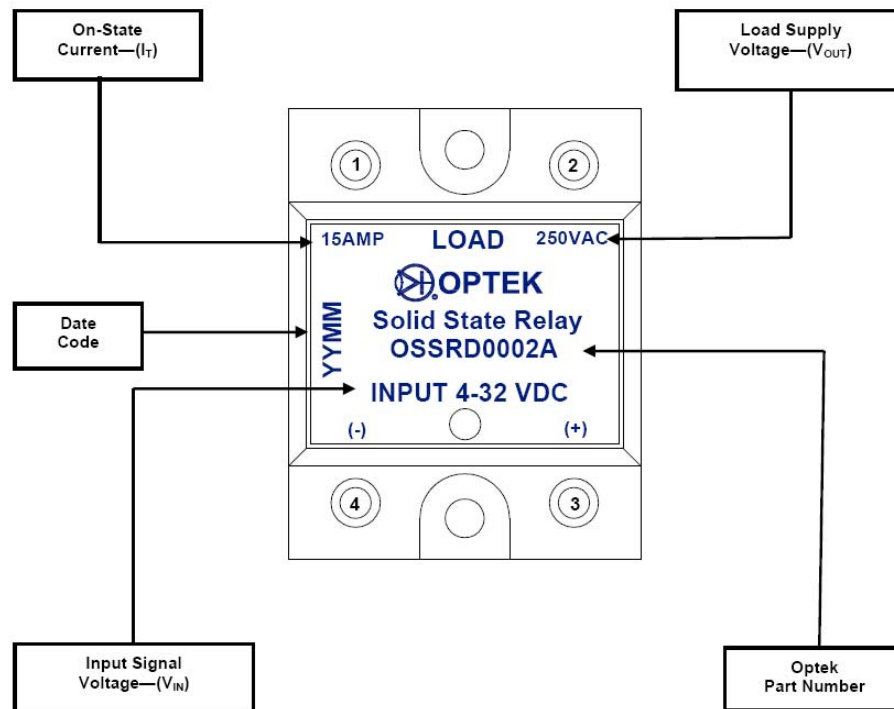

OPTEK reserves the right to make changes at any time in order to improve design and to supply the best product possible.

# Solid-State Relays

Panel Mount Package—VDC Input / VAC Output

OSSRD0001A thru OSSRD0006A



## Absolute Maximum Ratings ( $T_A = 25^\circ\text{C}$ unless otherwise noted)

<b>Storage Temperature</b> OSSRD0001A thru OSSRD0006A	-30° C to +125° C
<b>Operating Temperature</b> OSSRD0001A thru OSSRD0006A	-30° C to +100° C
<b>Isolation Voltage (Input to Output)</b> OSSRD0001A thru OSSRD0006A	4,000 Vrms

### Input Diode

<b>Input Signal Voltage—(<math>V_{IN}</math>)</b> OSSRD0001A thru OSSRD0006A	4- 32 VDC
<b>Drop-out Voltage—(<math>V_{do}</math>)</b> OSSRD0001A thru OSSRD0006A	1 VDC

### Output Triac

<b>RMS On-State Current - (<math>I_T</math>)</b> OSSRD0001A OSSRD0002A OSSRD0003A, OSSRD0005A OSSRD0004A, OSSRD0006A	10 Arms 15 Arms 25 Arms 40 Arms
<b>Peak One Cycle Surge Current - (<math>I_{surge}</math>)</b> OSSRD0001A OSSRD0002A OSSRD0003A, OSSRD0005A OSSRD0004A, OSSRD0006A	100 A 150 A 250 A 400 A
<b>Repetitive Peak-Off State Voltage—(<math>V_{DRM}</math>)</b> OSSRD0001A thru OSSRD0004A OSSRD0005A, OSSRD0006A	600 V 800 V
<b>Operating Frequency—(<math>f</math>)</b> OSSRD0001A thru OSSRD0006A	47—70 Hz
<b>Critical Rate of Rise of On-State Current—(<math>di/dt</math>)</b> OSSRD0001A thru OSSRD0006A	50 A/ $\mu$ S
<b>Load Supply Voltage—(<math>V_{OUT}</math>)</b> OSSRD0001A thru OSSRD0004A OSSRD0005A, OSSRD0006A	250 Vrms AC 480 Vrms AC

OPTEK reserves the right to make changes at any time in order to improve design and to supply the best product possible.

# Solid-State Relays

## Panel Mount Package—VDC Input / VAC Output

### OSSRD0001A thru OSSRD0006A



#### Electrical Characteristics ( $T_A = 25^\circ\text{C}$ unless otherwise noted)

SYMBOL	PARAMETER	MIN	TYP	MAX	UNITS	TEST CONDITIONS
<b>Input Diode</b>						
$V_{PU}$	<b>Pick-up Voltage</b> OSSRD0001A thru OSSRD0006A	-	-	4	VDC	$I_T = 1\text{Arms}$
$I_{IN}$	<b>Input Current</b> OSSRD0001A thru OSSRD0006A	5	-	12	mA	$V_{IN} = 4 - 32\text{ V}$
<b>Output Triac</b>						
$V_T$	<b>On-State Voltage</b> OSSRD0001A thru OSSRD0006A	-	-	1.5	Vrms	$I_T = 1\text{Arms}$
$I_{OP}$	<b>Operating Current</b> OSSRD0001A thru OSSRD0004A OSSRD0005A, OSSRD0006A	50 50	- -	- -	mArms	$V_{out} = 240\text{Vrms}$ $V_{out} = 480\text{Vrms}$
$I_{leak}$	<b>Leakage Current</b> OSSRD0001A thru OSSRD0004A OSSRD0005A, OSSRD0006A	- -	3.5 -	7 14	mArms	$V_{out} = 240\text{Vrms}$ $V_{out} = 480\text{Vrms}$
$dv/dt$	<b>Critical Rate of Rise of Off-State Voltage</b> OSSRD0001A thru OSSRD0006A	50	200	-	V/ $\mu\text{s}$	See Note 1.
ZC	<b>Zero-Cross Voltage</b> OSSRD0001A thru OSSRD0006A	-	Yes	-	-	-
$V_{OUT}$	<b>Load Voltage Rating</b> OSSRD0001A thru OSSRD0004A OSSRD0005A, OSSRD0006A	50 75	- -	280 480	VAC	$I_T = 50\text{mArms MIN}$
$I_{FT}$	<b>Minimum Trigger Current</b> OSSRD0001A thru OSSRD0004A OSSRD0005A, OSSRD0006A	- -	- -	10 25	mA	$V_{DRM} = 600\text{ V}$ $V_{DRM} = 800\text{ V}$
$R_{iso}$	<b>Isolation resistance Input to Output</b> OSSRD0001A thru OSSRD0006A	$10^{10}$	-	-	$\Omega$	DC500 V
$T_{ON}$	<b>Turn-on Time</b> OSSRD0001A thru OSSRD0006A	-	-	8.3	mS	60Hz AC
$T_{OFF}$	<b>Turn-off Time</b> OSSRD0001A thru OSSRD0006A	-	-	8.3	mS	60Hz AC
$R_{th(j-c)}$	<b>Thermal Resistance (between junction and case)</b>	-	1.3	-	$^\circ\text{C/W}$	-

**Note1:** Output (dv/dt) protection is provided in all models, and they are designed to switch resistive or inductive loads to 0.2 factor. The dv/dt rating is based on source impedance of 50 ohms.

OPTEK reserves the right to make changes at any time in order to improve design and to supply the best product possible.

# Solid-State Relays

## Panel Mount Package—VDC Input / VAC Output

### OSSRD0001A thru OSSRD0006A



## OSSRD0001A, OSSRD0002A, OSSRD0003A, OSSRD0004A

### Characteristic Data Curves

**Fig.1** RMS On-state Current vs. Ambient Temperature

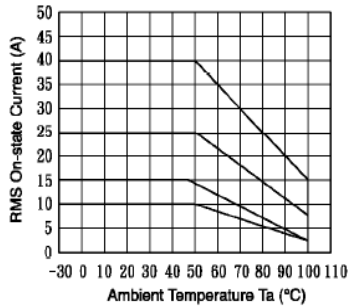

**Fig.2** Surge Current vs. Time  
f=60Hz  
Tj=25°C

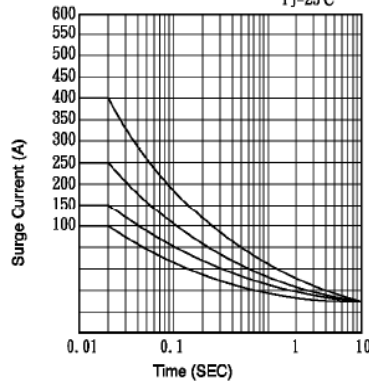

**Fig.3** Open Circuit Leak Current vs. Supply Voltage  
Ta=25°C

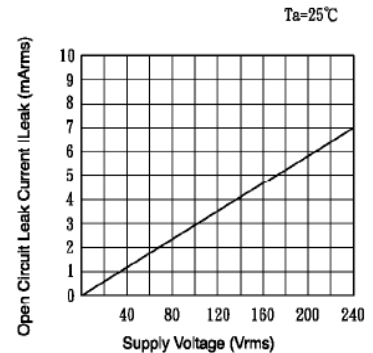

**Fig.4** RMS On-state Current vs. Case Temperature

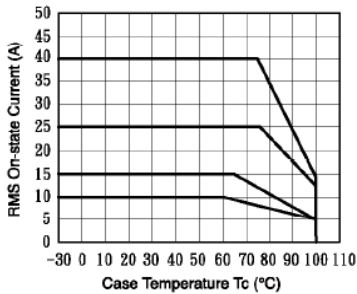

**Fig.5** Input Voltage vs. Ambient Temperature

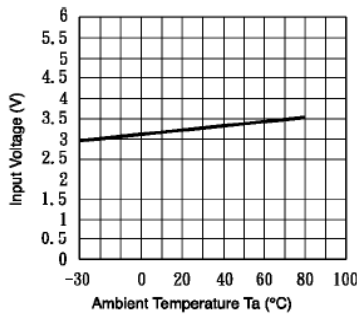

**Fig.6** Input Current vs. Input voltage

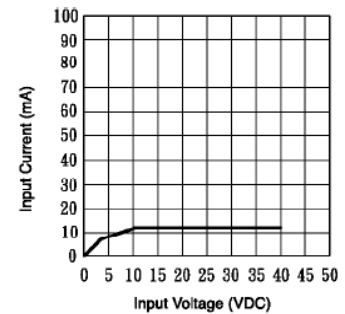

**Fig.7** Action waveform

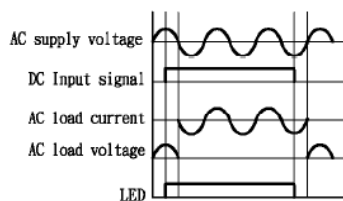

**Fig.8** WIRING DIAGRAM

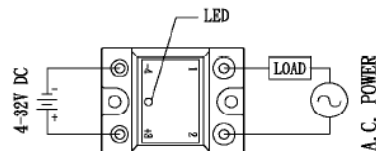

OPTEK reserves the right to make changes at any time in order to improve design and to supply the best product possible.

# Solid-State Relays

## Panel Mount Package—VDC Input / VAC Output

### OSSRD0001A thru OSSRD0006A



## OSSRD0005A

### Characteristic Data Curves

**Fig.1** RMS On-state Current vs. Ambient Temperature

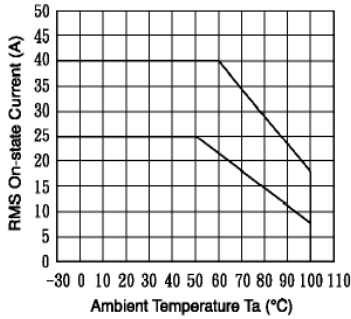

**Fig.2** Surge Current vs. Time

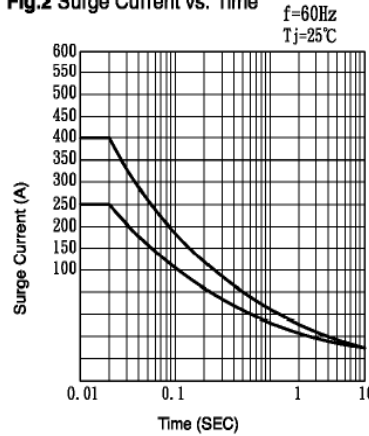

**Fig.3** Open Circuit Leak Current vs. Supply Voltage

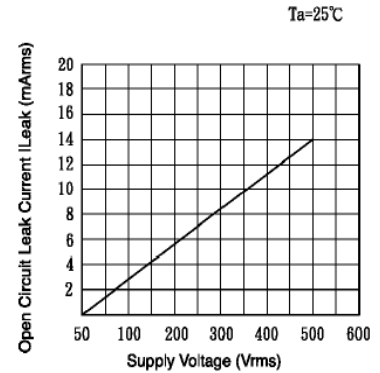

**Fig.4** RMS On-state Current vs. Case Temperature

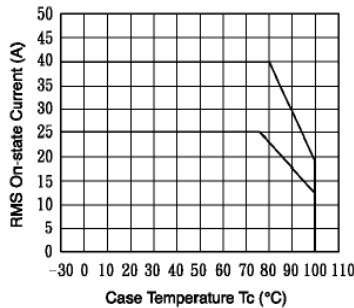

**Fig.5** Input Voltage vs. Ambient Temperature

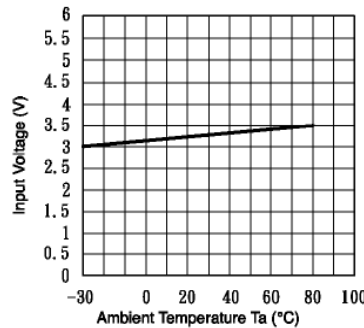

**Fig.6** Input Current vs. Input voltage

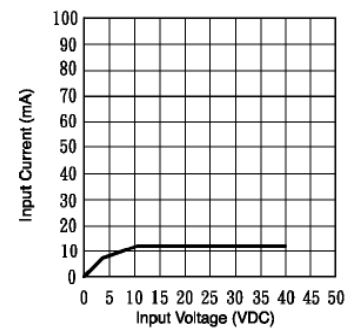

**Fig.7** Action waveform

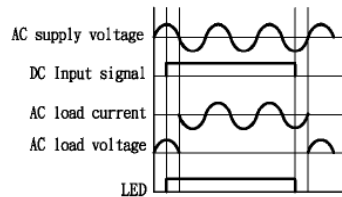

**Fig.8** WIRING DIAGRAM

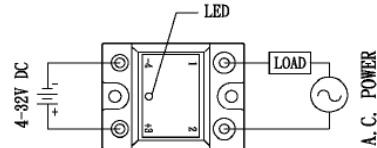

OPTEK reserves the right to make changes at any time in order to improve design and to supply the best product possible.

# Solid-State Relays

## Panel Mount Package—VDC Input / VAC Output

### OSSRD0001A thru OSSRD0006A



## OSSRD0006A

### Characteristic Data Curves

**Fig.1** RMS On-state Current vs. Ambient Temperature

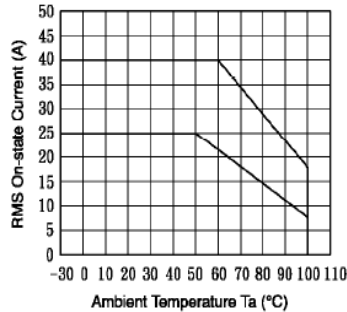

**Fig.2** Surge Current vs. Time

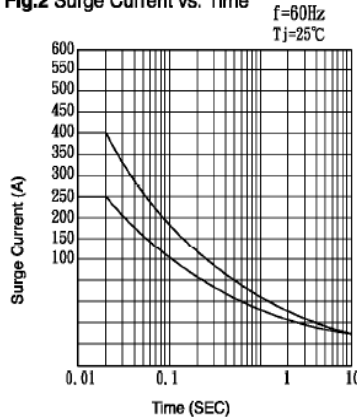

**Fig.3** Open Circuit Leak Current vs. Supply Voltage

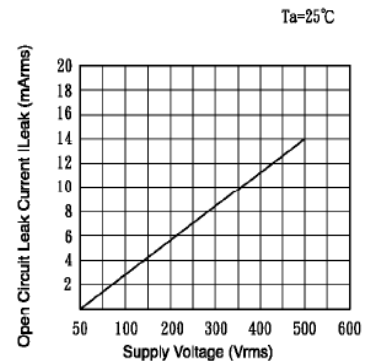

**Fig.4** RMS On-state Current vs. Case Temperature

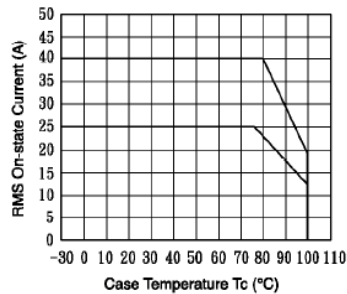

**Fig.5** Input Voltage vs. Ambient Temperature

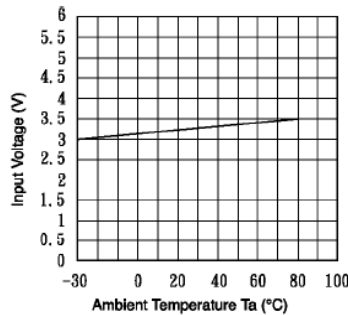

**Fig.6** Input Current vs. Input voltage

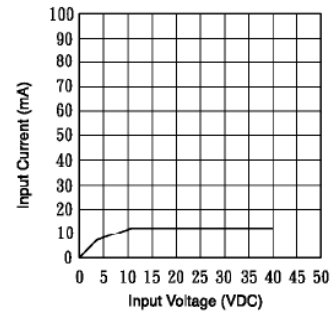

**Fig.7** Action waveform

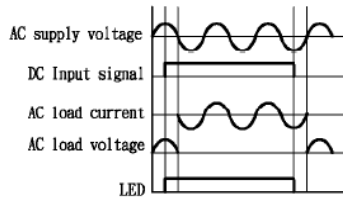

**Fig.8** WIRING DIAGRAM

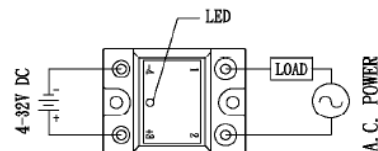

OPTEK reserves the right to make changes at any time in order to improve design and to supply the best product possible.



# Solid-State Relays

Panel Mount Package—VDC Input / VAC Output  
OSSRD0001A thru OSSRD0006A



## Quality and Reliability Requirements

Parameter	Failure Criteria	Test Conditions
Room Temperature Operating Life (for light emitting diodes only)	± 20%	T <sub>A</sub> = 25°C, I <sub>F</sub> = 60mA or max. rated, Time = 1000 hours
High Humidity, High Temperature Reverse Bias	± 20%	JEDEC, Method A101-B T <sub>A</sub> = 85°C, Humidity = 85%RH, Time = 1000 hours,
High Temperature Forward Bias	± 20%	JEDEC, Method A108-A T <sub>A</sub> = 70°C, I <sub>F</sub> = 20mA, Time = 1000 hours
Autoclave	0 Fail	T <sub>A</sub> = 121°C, Pressure = 15psi, Humidity = 100%
IR Reflow / Solderability Test	0 Fail	JEDEC (J-STD-020) / MIL-STD-883E, Method 2003.7
MTTF @ 90% confidence	150,000 Min.	@ 25°C, 25mADC
Moisture Sensitivity Level	MSL 1	per JDEC stnd J-STD-020B
Glass Transition of body	125°C Min.	DSC test method
Temperature Humidity-Bias	± 20%	85°C, 85%RH, 500Hrs, 80% min lceo
Temperature Cycle	± 20%	per Method 1010.7 of MIL-STD-883E
High Temperature Storage	± 20%	85°C, 500Hrs

## Label Identification

### DESCRIPTION:

Size: 3" (7.5 cm) X 2.2" (5.5 cm)  
Lettering shall be black on white background.  
Format shall be as:

### Notes:

- The DATE CODE is a 4-digit code for date of manufacture where YY is the last two digits of the year, and WW is week number of manufacture.
- The LOT I.D. is the manufacturing location lot identification where Y is the year of manufacture, NNNN is a sequential lot identifier, and DDD is the day of the year of manufacture. – or use equivalent label format.

 Carrollton, TX, USA MADE IN TAIWAN RoHS compliant
OPTEK P/N <u>  OSSRD0001A  </u> 
QTY. <u>          —          </u> 
DATE CODE <u>  (Y Y W W)  </u> 
LOT I.D. <u>  (Y - N N N N D D D)  </u> 

OPTEK reserves the right to make changes at any time in order to improve design and to supply the best product possible.

# Solid-State Relays

Panel Mount Package—VDC Input / VAC Output

OSSRD0001A thru OSSRD0006A



## Packaging Information:

Optek's Solid-State Relays Part Numbers (4-Pin SIP)		Packaging Quantities	Tubes		Inner		Medium Carton			Large Carton		
			Qty	Weight (g)	53.5 x 7.0 x 7.5 cm		55.5 x 30.7 x 16.5 cm			55.5 x 30.7 x 23.5 cm		
		Package Type	Qty	Weight (g)	Qty	Weight (kg)	Qty	Net Weight (kg)	Gross Weight (kg)	Qty	Net Weight (kg)	Gross Weight (kg)
SSR	OSSRD2001D, OSSRD2002A	4 Pin SIP (24mm x 37mm)	10	213	80	1.80	640	14.4	15.4	960	21.6	22.9
	OSRRD1001A - OSSRD1006A	4 Pin SIP (32mm x 24mm)	20	421	80	1.90	640	15.2	16.2	960	22.8	24.1

  

Optek's Solid-State Relays Part Numbers (Panel Mounts)		Packaging Quantities	Trays		Small Carton			Medium Carton			Large Carton		
			36 x 20 x 37 cm		37 x 21 x 11 cm			37 x 21 x 17 cm			37 x 21 x 32 cm		
		Package Type	Qty	Weight (g)	Qty	Net Weight (kg)	Gross Weight (kg)	Qty	Net Weight (kg)	Gross Weight (kg)	Qty	Net Weight (kg)	Gross Weight (kg)
SSR	OSSRD0001A - OSSRD0006A OSSRA0007A - OSSRA0012A	Panel Mounts (42.5mm x 58mm)	10	920	30	2.80	3.3	50	4.7	5.4	100	9.5	10.5

## Tray and Carton Packaging Specifications:

### Tray Packaging Dimensions

All dimensions in centimeters (mm)

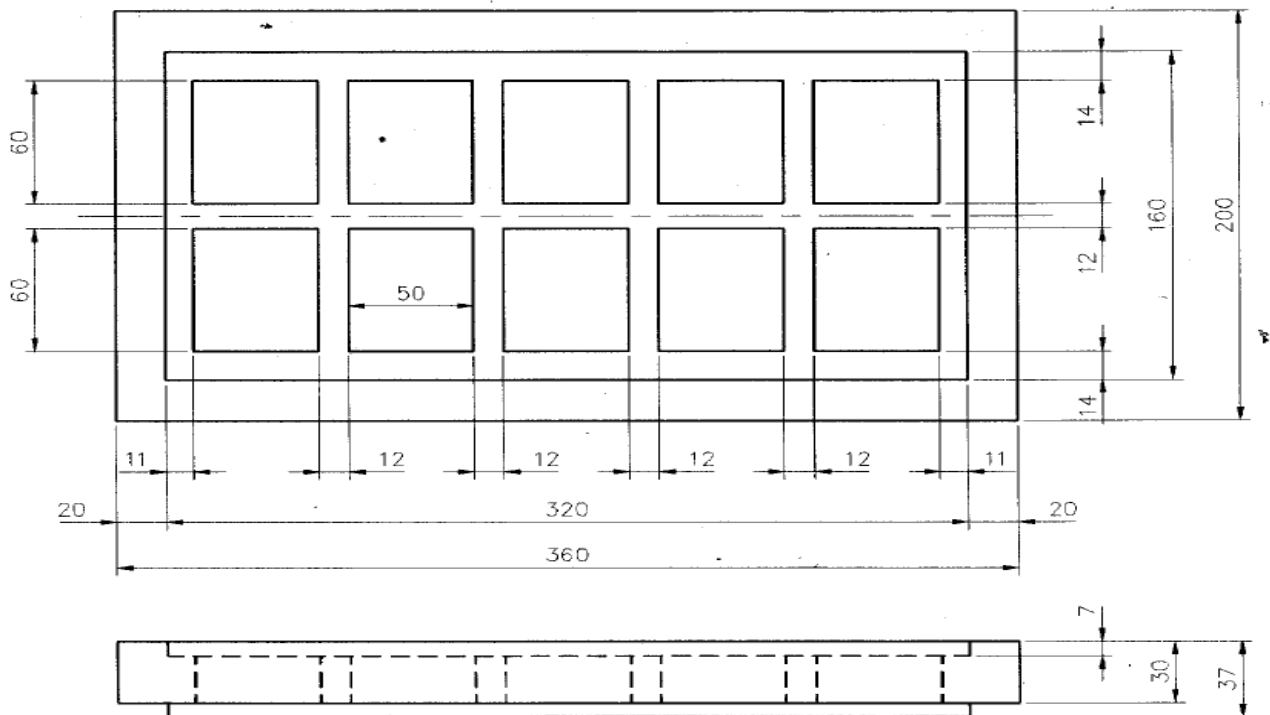

All dimensions in millimeters (mm)

OPTEK reserves the right to make changes at any time in order to improve design and to supply the best product possible.

# Solid-State Relays

Panel Mount Package—VDC Input / VAC Output  
OSSRD0001A thru OSSRD0006A



## Tray and Carton Packaging Specifications (Cont.):

### Carton Packaging Dimensions

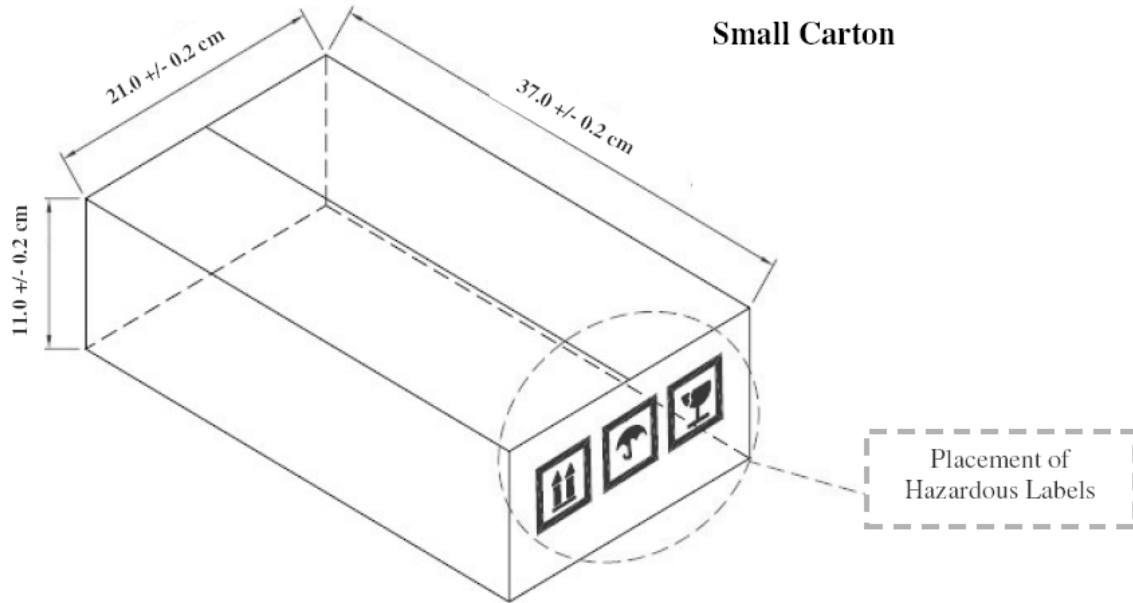

All dimensions in centimeters (cm)

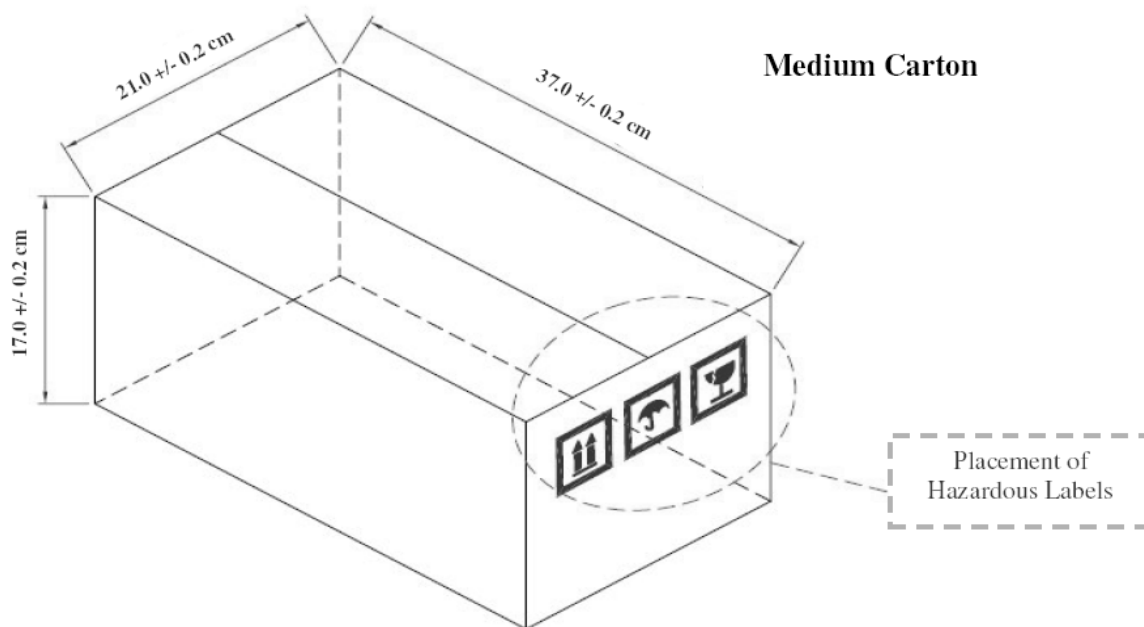

All dimensions in centimeters (cm)

OPTEK reserves the right to make changes at any time in order to improve design and to supply the best product possible.

# Solid-State Relays

## Panel Mount Package—VDC Input / VAC Output

### OSSRD0001A thru OSSRD0006A



### Tray and Carton Packaging Specifications (Cont.):

#### Carton Packaging Dimensions

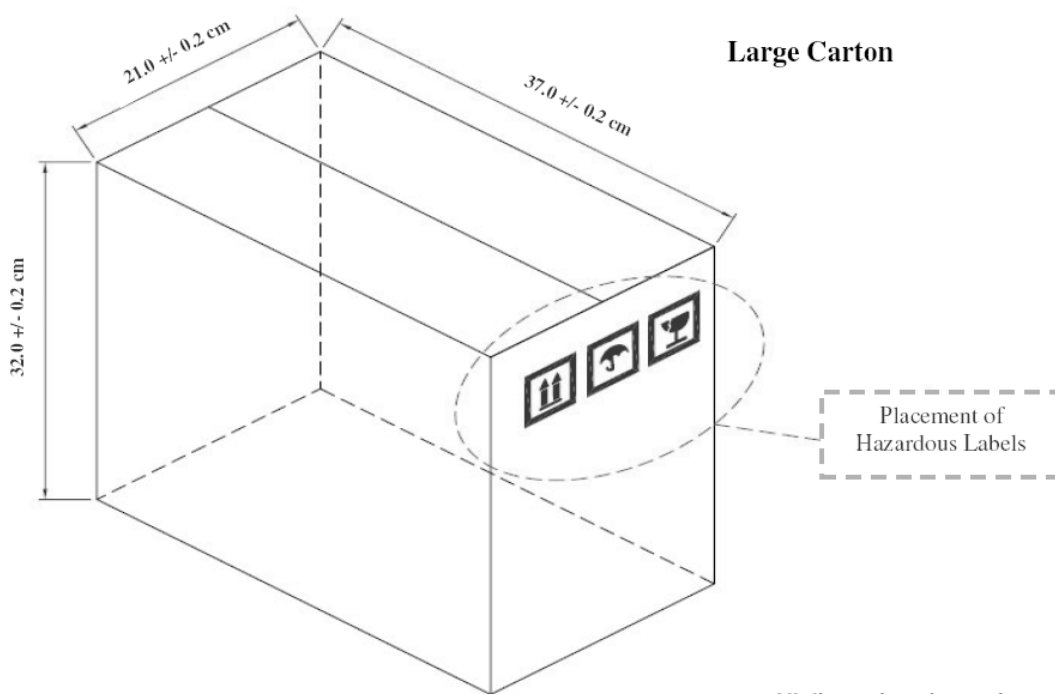

All dimensions in centimeters (cm)

OPTEK reserves the right to make changes at any time in order to improve design and to supply the best product possible.