

5

4

3

2

1

D



C

B

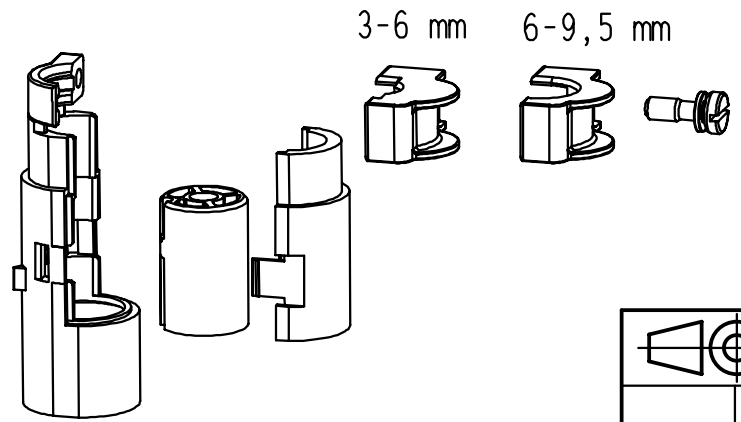
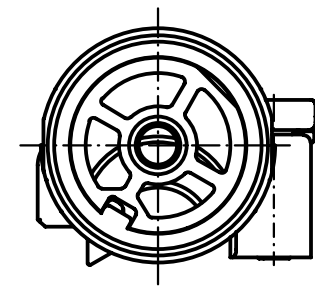
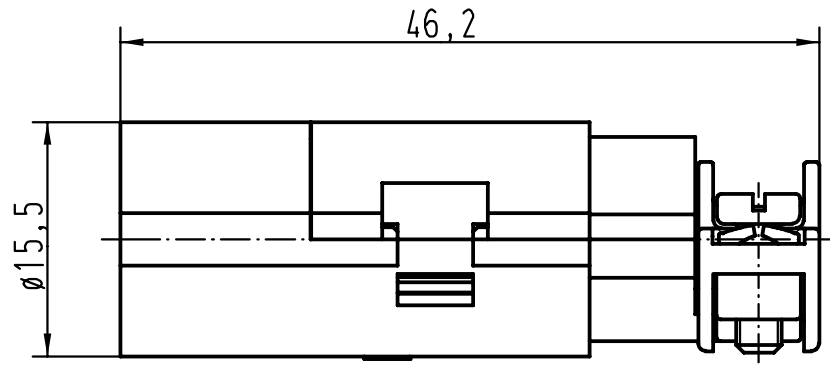
A



Lieferform: Einzelteile/
Kind of delivery: piece parts

 All Dimensions in mm Original Size DIN A 4			Techn. Character.			Nicht tolerierte Masse/ Free size tolerances		
				Dat.	Name	Massstab/Scale 2:1	Han Koax m-c Kabeldurchmesser 3-6 und 6-9,5 mm/ cable diameter 3-6 and 6-9,5 mm	
			Detail.	15.06.00	ROH.			
			Insp.		Sdt			
			Stand.					
28181	05.07.00	Gä	HARTING KGaA				TB 09 15 001 3013	
28176			D-32339 ESPELKAMP					
Mod.	Dat.	Name						
							Sub.	Blatt/ page

5

4

3

2

1

D

C

B

A

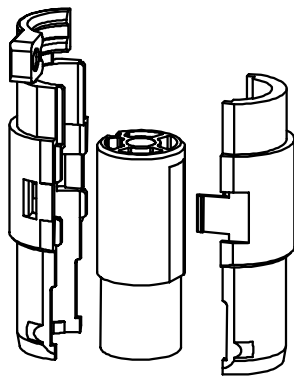
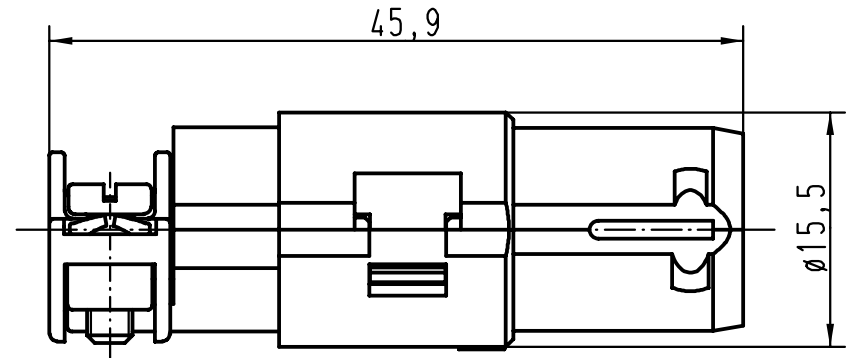
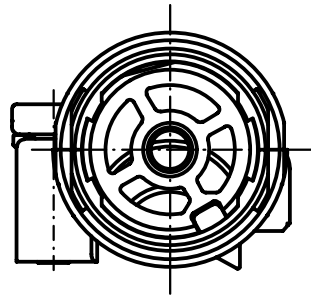

3-6 mm

6-9,5 mm

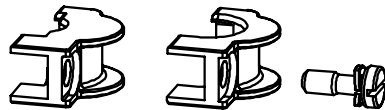

Lieferform: Einzelteile/
Kind of delivery: piece parts

All Dimensions in mm Original Size DIN A 4			Techn. Character.			Nicht tolerierte Masse/ Free size tolerances		
				Dat.	Name	Massstab/ Scale 2:1	Han Koax f-c Kabeldurchmesser 3-6 und 6-9,5 mm/ <i>cable diameter 3-6 and 6-9,5 mm</i>	
			Detail.	15.06.00	ROH.			
			Insp.		Sdt			
			Stand.					
28181	05.07.00	Gä	HARTING KGaA				TB 09 15 001 3113	
28176			D-32339 ESPELKAMP					
Mod.	Dat.	Name						
							Sub.	Blatt/ page