

—• Interface Modules

Full Line Catalog 2010/2011



WAGO Registered Trademarks



WAGO®

CAGE CLAMP®

CAGE CLAMP® **S**

POWER CAGE CLAMP

FIT CLAMP®

PUSH WIRE®

TOPJOB®

TOPJOB® **S**

X-COM®

X-COM® **S**

WINSTA®

JUMPFLEX®

TO-PASS®

ProServe®

WAGO Full Line Catalogs

Volume 1, Rail-Mounted Terminal Block Systems

- Rail-Mounted Terminal Blocks
- Modular Connectors (X-COM®-SYSTEM)
- Terminal Strips
- Patchboard Systems
- Shield (Screen) Connecting System
- PUSH WIRE® Connectors for Junction Boxes

Volume 2, Connectors and PCB Terminal Blocks

- PCB Terminal Blocks
- Feedthrough Terminal Blocks
- MULTI CONNECTION SYSTEM
- PCB Connectors
- Specialty Connectors

Volume 3, I/O-SYSTEM

- Modular I/O-SYSTEM IP20
- Wireless Technology, TO-PASS® Telecontrol Technology
- Industrial Switches, PERSPECTO
- Modular I/O-SYSTEM IP67, Block I/O-SYSTEM IP67
- Sensor/Actuator Boxes IP67, Cables and Connectors IP67
- Power Supplies

Volume 4, Interface Modules

- Relay - Optocouplers - Special Functions
- Interface Modules
- Transducers
- Power Supplies
- Overvoltage Protection
- Wireless Technology
- Empty Housings and Mounting Carriers

Volume 5, WINSTA® Connector System

- WINSTA® MINI Connectors
- WINSTA® MIDI Connectors
- WINSTA® MAXI Connectors
- WINSTA® RD Cable Assemblies
- WINSTA® KNX Connectors
- WINSTA® IDC Flat Cables



Handling of WAGO Connection Technologies*

CAGE CLAMP®S



Universal connection with "SPECIAL"

Handling:
Open the clamp, insert wire and release the clamp - done! Solid conductors and fine-stranded conductors with ferrules are connected by simply pushing them in - no operating tool needed.

CAGE CLAMP®

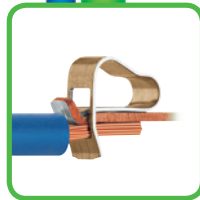

Universal connection of solid, stranded and fine-stranded conductors

Handling:
Open the clamp, insert wire and release the clamp - done!

POWER CAGE CLAMP®

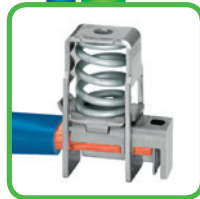

Universal connection of conductors larger than 6 AWG (16 mm²)

Handling:
- To open the clamp with a standard hex wrench or operating tool, and turn approximately twice counter-clockwise.
- Latch holds clamp open.
- Insert conductor.
- A small counter-clockwise rotation releases the latch.

FIT CLAMP®



Insulation displacement connection (IDC)

Handling:
Push unstripped conductor into the IDC contact using an operating tool.

PUSH WIRE®

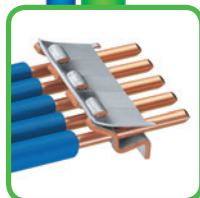

PUSH WIRE® connection for solid wires and stranded wires (depending on product used)

Handling:
Solid and stranded conductors that are rigid enough are connected by simply pushing them in - no operating tool needed.

* Please follow the product instructions for product-specific handling.

Contents

Volume 4

1

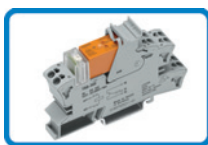

Relays – Optocouplers – Special Functions

1

2



Interface Modules

2

3



Transducers

3

4



Power Supplies

4

5

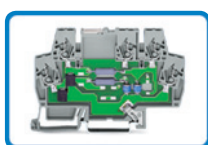

Overvoltage Protection

5

6



Wireless Technology

6

7



Empty Housings and Mounting Carriers

7

8



Accessories

8

9



Technical Section

9

An Interface Solution for

JUMPFLEX® - Transducers / Relay and Optocoupler Modules
857 Series

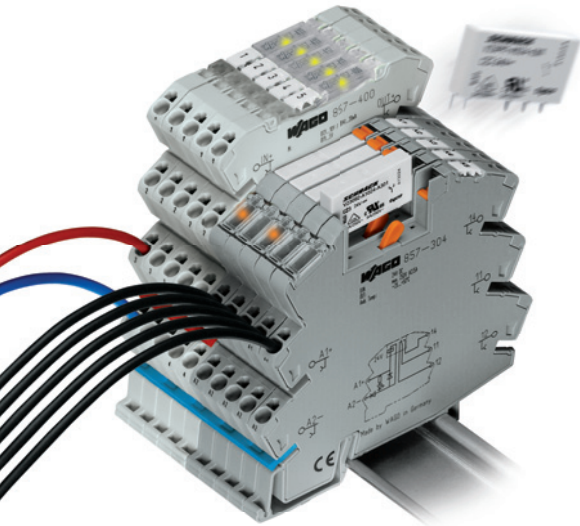

JUMPFLEX® - 8-Channel Adapter
857 Series

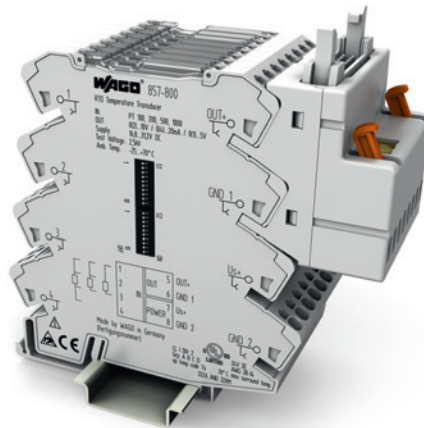

Interface Modules
289 Series

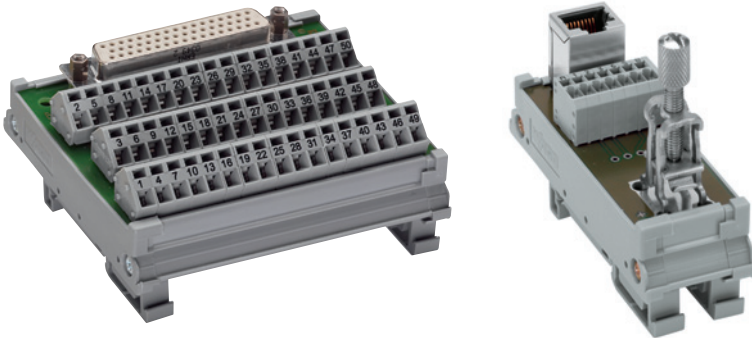

EPSITRON - Power Supplies
787 Series

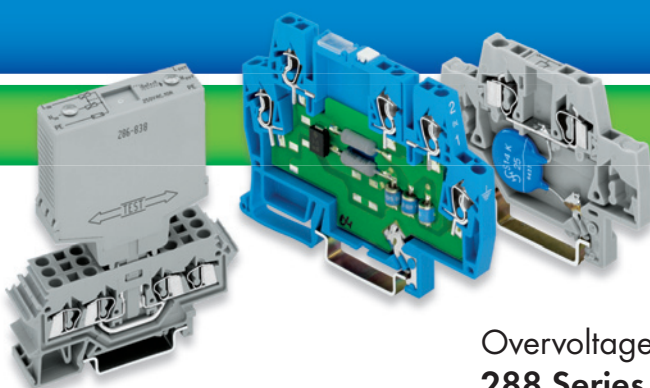

Overvoltage Protection
288 Series



All Applications

Relay Modules and
Optocoupler Modules
859 Series

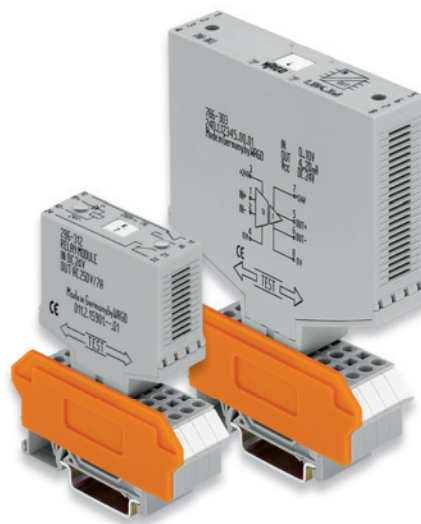
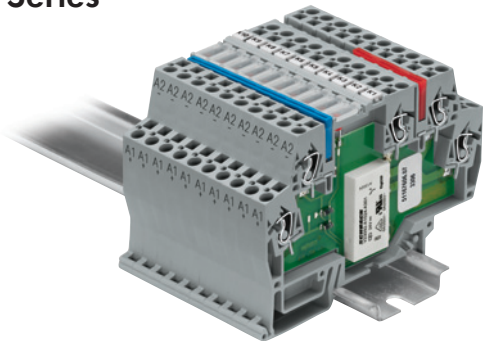

Pluggable Function Modules
286 and 786 Series

Sockets for Miniature Switching Relay /
Optocoupler
788 Series

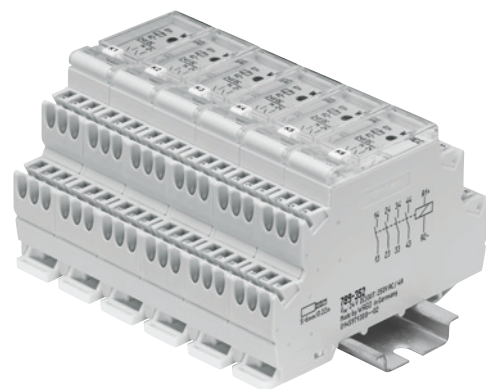
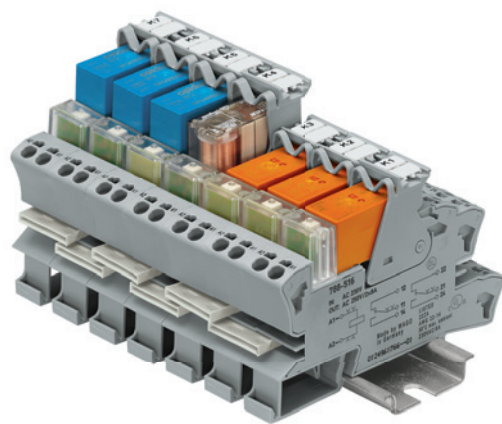

Relay Modules in
DIN-Rail Mounted Enclosure
789 Series

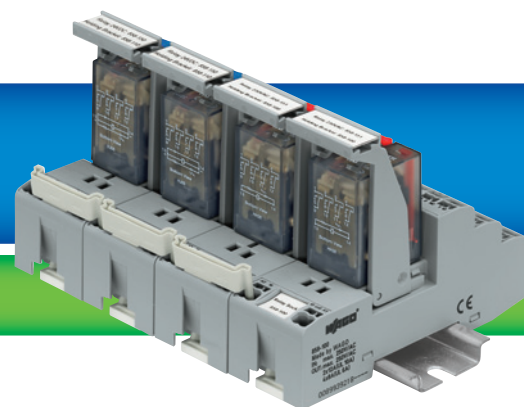

Sockets with Industrial Relay
858 Series

WAGO Interface Modules

Design and housing possibilities

Nowadays when equipment is designed many scenarios need to be considered. Some of which are user and maintenance friendly, limited budgets, safety, availability, space requirements and simplicity in design and usage.

WAGO AUTOMATION offers interface modules in various shapes and sizes to overcome any of the restraints posed by space requirements.

This enables any demands and needs to be fulfilled using these different designs, such as pluggable function and interface modules, relay and optocoupler modules, etc.

788 Series Relay Sockets with Pluggable Miniature Switching Relay

The WAGO Series 788 relay socket forms an excellent basis for switching applications using pluggable miniature switching relays (1 or 2 changeover contacts) in industrial and process automation.

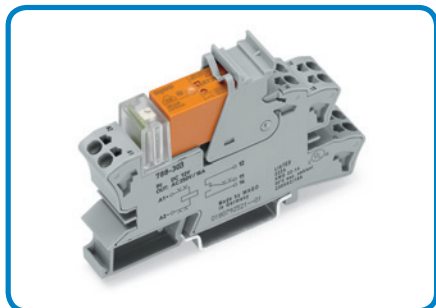

Relay socket with pluggable miniature switching relay

In addition to its compact design 15x53x86mm (W x H x D), the relay socket also stands out thanks to a number of user-oriented features, with the associated benefits for the user.

The lever facilitates relay replacement even when the relay sockets are placed close to each other.

The sockets can be ordered as complete components including relay and status indication or as a single component.

857 Series Transducers and Relay Modules



Transducers and relay modules

The new 6mm-wide WAGO isolation amplifiers and transducers not only share a common profile, but in addition one in line jumper can be used to connect the supply voltages, etc. to all modules, doing away with the need to wire each connection. The smaller relay modules also fit perfectly in this scenario. The pluggable relays can simply be replaced from the top.

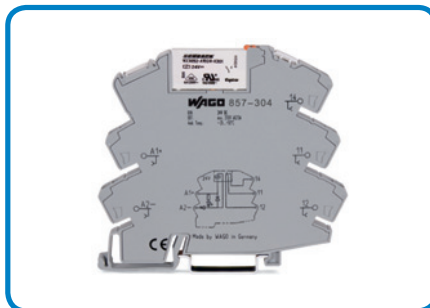

Relay module with pluggable miniature switching relay

In order to cover all application areas with one product family, it is intended to offer five different groups for the transducers alone: these include fixed and configurable isolating amplifiers, passive isolators, power supply isolators (also for HART applications), signal duplicators and temperature transducers for Pt100 and thermocouples.

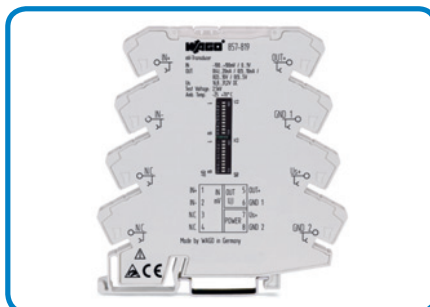

Transducer

286 / 786 Series Pluggable Function Modules

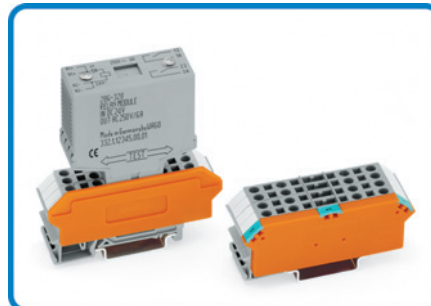

Pluggable function modules

The terminal blocks for pluggable modules offer the greatest degree of flexibility and maintenance-friendly service. The terminal block for pluggable modules is mounted on the carrier rail and wired like a normal terminal block. If service is required, this element can be replaced in one step, without having to deal with the system wiring. This saves space and additional wiring effort.



Pluggable function modules

The optocoupler and relay modules are ideal additions to a comprehensive function module program, allowing any required functions to be implemented in a control cabinet by means of a pluggable module system. Large enclosures of the Series 786 are available for more complex functions, such as transducers.



Pluggable signal conditioning modules

859 Series Relay Modules and Optocoupler Modules

The Series 859 is a complete product series that is ideal for the interface level in any industrial application, thanks to the wide range of relays and optocouplers.

287 / 288 Series DIN-Rail-Mountable Modules - Relay Modules and Sockets

The relay and PLC interface modules in the mounting socket that can be fitted on carrier rails ensure quick and easy linking of signals from periphery devices. The fully wired modules, with up to 16 high-performance relay outputs, provide for direct switching of actuators and other coupling elements in the field.

789 Series Relay Modules in DIN-Rail-Mountable Enclosure

The range of uses for the WAGO latching relays and switching relays of Series 789 spans from simple lighting controls in building services, such as in construction of apartments, hotels, office buildings or parking garages, etc., up to installations in industrial control cabinets.

The 17.5mm-wide design in series bay enclosures is particularly well-suited for installation in distribution boards and meter mounting boards.

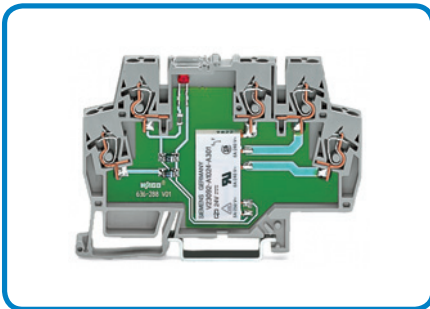

Relay module

These units excel in tight spaces, thanks to their narrow 6mm design. Simple commoning at the control and load side enables quick and easy looping through of common input and output potential.

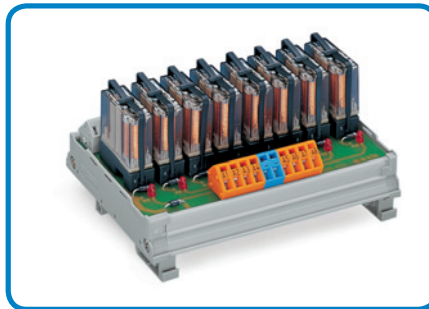

DIN-rail-mountable modules - relay modules

The requisite free-wheeling and reverse voltage protection diodes are also integrated to ensure a long service life of the products.

Other interface modules available as:

Multiple modules with plugged relays that are easy to replace, without affecting existing wiring.

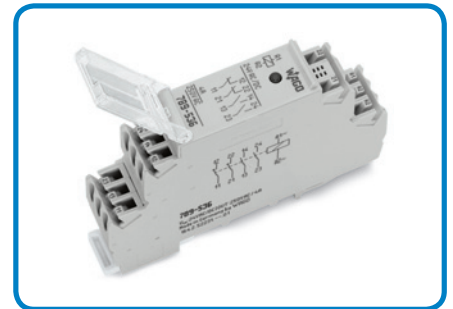

Relay modules in DIN-rail-mountable enclosure

The series bay enclosures are used for installation of other electronics devices having a large scope of functions and higher switching capacities; these come in sizes of 2 module spaces (35mm) and 4 module spaces (70mm).



Optocoupler module

Its robust design and the shock-proof CAGE-CLAMP® connecting technology used ensures continuous and uninterrupted operation of any kind of system.

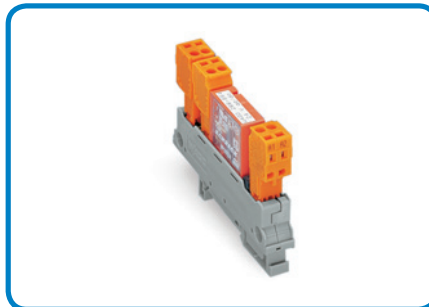

DIN-rail-mountable modules - relay modules



EnOcean radio receiver in DIN-rail-mountable enclosure

PCB terminal blocks and connectors from the extensive WAGO program can be installed in the enclosures to obtain customized development of interface components.

Installation is quick and reliable on the 35mm carrier rail.

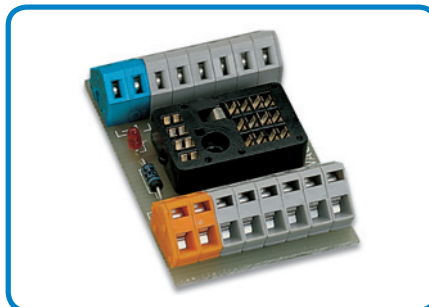

Relay socket

WAGO Transducers and Relay Modules

JUMPFLEX®, 857 Series

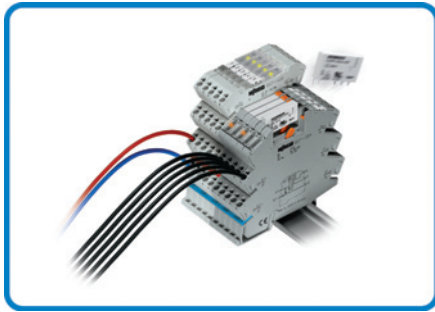

The perfect match of housing and electronics is the key to a highly successful device. This is exactly what has been achieved by WAGO with the transducers and relay modules of the 857 Series.

Analog systems technology – Basics

Problems can arise in signal processing in industrial systems of analog standard signals (such as 0-10V or 0-20mA) which can have an adverse effect on overall fault-free signal processing. Problems such as potential differentials arising from interlinked measuring circuits can be efficiently prevented using WAGO transducers, with their associated electrical isolation.

Decoupling (Isolation) methods

A basic distinction is made between active and passive isolation.

Active isolation

Depending on the design and model in use, devices are available that incorporate electrical 3-way isolation. 4-way isolation is provided in a signal duplicator. This means that all inputs, outputs and supply circuits are electrically isolated from one another with a 2.5 kV proof voltage.

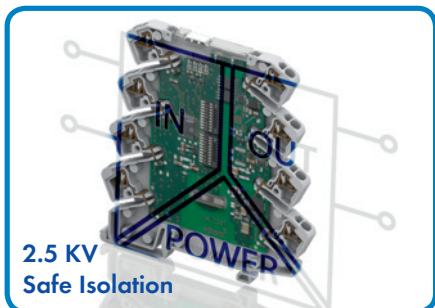

This ensures that the greatest possible safety and reliability is achieved for the system and any devices connected to the system. For 3-way isolation provides for electrical isolation between the transducers and the control system and between the control system and the control elements.

At the input side the devices required active signals, i.e., the sensor signal is generated by a dedicated supply voltage.

These devices provide a filtered and amplified signal at the output side.

Passive isolation

A passive isolator draws power for signal transmission from the input circuit. In this case, the sensor must supply a power level adequate for the device and must also drive the working resistance.

As a result, it must be ensured that the current-driving power of the sensor is sufficient to drive the maximum current of 20mA via the passive isolator (with the device-specific voltage drop), as well as the working resistance.

This can be calculated using the following equation:

$$U_S \geq U_E = U_V + 20 \text{ mA} \times R_B$$

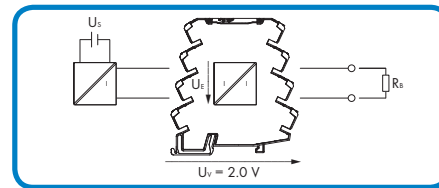

Typical equation for a passive isolator (857-451) for a 20mA signal.

$$U_S \geq U_E = 2.0 \text{ V} + 20 \text{ mA} \times 600 \Omega$$

$$U_S \geq U_E = 14 \text{ V}$$

Temperature measuring techniques

Resistance thermometers, such as Pt100 sensors, alter their resistance level as a function of temperature. For example, a rise in temperature will result in an increase in the resistance level. This resistance level is registered by the JUMPFLEX® devices (for example 857-800) and transformed into an analog output signal and simultaneously electrically isolated using a 2.5kV proof voltage.

The analog standard signal can be a current signal in the 0-20 mA, 4-20 mA 0-10 mA or 2-10 mA range, or a voltage signal in the 0-10 V, 2-10 V, 0-5 V or 1-5 V range.

Parameterization, commissioning and diagnostics using WAGO-frame

A portion of the JUMPFLEX® transducer can be configured for parameterization, commissioning and diagnostics of field devices using WAGOframe, a software based on the FDT/DTM standard.

The WAGOframe FDT frame application provides a wizard, which simplifies the operation of components, such as WAGO JUMPFLEX® DTMs. This wizard guides the user through the different operating modes of DTM device drivers.

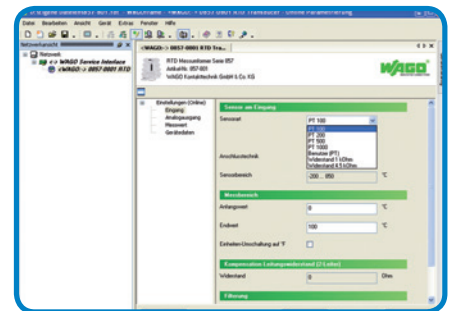

3 different connecting techniques are employed for acquisition of resistance thermometers:

2-wire connecting technique

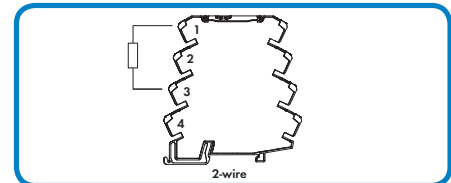

The resistance thermometer is connected to the JUMPFLEX® transducer via a two-wire conductor. As the feed-in resistance can directly affect results, which would invalidate them, it must be ensured that the distance between the measuring point and the device is kept as small as possible. This distance should not exceed 10m in this case. If this distance can not be ensured, the 857-801 unit can be used provide compensation for the incoming resistance using the configuration software.

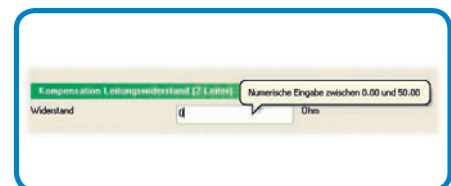

Compensation for line resistance (2-wire)

A resistance value can be input into this field for compensation of the line resistance for 2-wire sensors within a range of 0-50 Ω .

Adjusting the values for resistance compensation is only possible by setting the sensor wire connection to 2-wire. Otherwise the field is displayed in gray and no values can be entered. Using 3- and 4-wire sensors, the input cable resistance is compensated via the connection technology and does not enter into the measuring results.

3-wire connecting technique

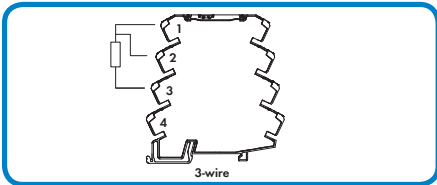

The 3-wire connecting technique minimizes the effect of line resistance. The resistance thermometer is gauged via two measuring circuits implemented in the JUMPFLEX® transducer. One measuring circuit serves as the reference circuit. Line resistance can be compensated for in this manner.

The measuring results can, however, nevertheless be affected by different line lengths or by different ambient temperatures. No further line adjustment is usually necessary, as the same line lengths and the same ambient temperatures exist in most cases.

4-wire connecting technique

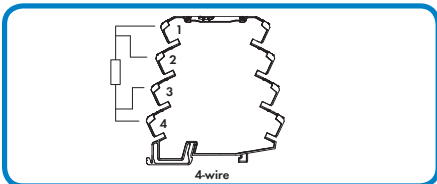

The most accurate measuring method employs the 4-wire connecting technique. This involves feeding in a low supply current via two fully isolated measuring circuits via two lines and measuring the voltage drop across the resistance thermometer via the other two lines. This method offers the advantage not being influenced by line resistance or temperature-induced fluctuations, as the voltage

drop for the incoming and outgoing lines can be measured separately and compensation provided for as required. Again, no line adjustment is required here.

Thermocouples

In contrast to resistance thermometers, thermocouples are active sources that generate output in the microvolts range. Thermocouples have very low resistance and are therefore noise-free. Preferred applications include tasks in environments with high temperatures, such as in ovens or machines in the plastics industry.

The joining of two different materials at the thermocouple results in different energy of formation of the metal atom electrons, yielding a thermoelectric voltage. The level of this thermoelectric voltage is a function of the material and of temperature.

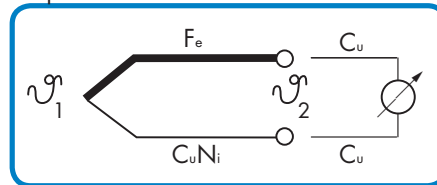

If the temperature at measuring point θ1 is the same as the temperature at reference point θ2, no current will flow, as the two component voltages cancel one another out. However, if the temperatures at the measuring point and at the reference point are different, differing voltage levels are produced which do not completely cancel one another out, resulting in a flow of current.

To summarize then, a thermocouple only measures a difference in temperature. This is yielded from the difference between the thermoelectric voltage levels at the measuring point and at the reference point. The voltage fluctuation produced by the thermoelectric effect is very low and is generally only a few microvolts per Kelvin. Therefore, only the difference between the thermoelectric voltages of the materials used is of significance, for example, thermocouple type J, iron (Fe) and constantan (CuNi).

Also of some significance in the connection point temperature. This temperature must be known in order to derive the ambient temperature from the thermoelectric voltage level. This is why the temperature at the connection point is measured by JUMPFLEX® transducers. This value, also referred to as the reference or cold junction, can then be compensated for. (cold junction compensation)

Cold-junction compensation can be acti-

vated and de-activated just by a click using the configuration software (default setting: ON (activated)).

Table for Thermocouples

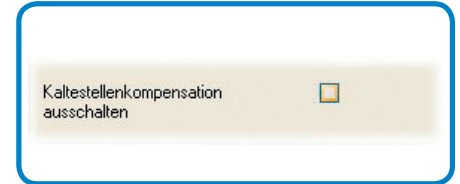

Type of sensor	Thermocouple materials	Measuring range
J *)	Fe-CuNi	-210 °C ... +1200 °C
K *)	NiCr-Ni	-200 °C ... +1372 °C
E *)	NiCr-CuNi	-200 °C ... +1000 °C
N *)	NiCrSi-NiSi	-200 °C ... +1300 °C
R *)	Pt13Rh-Pt	+250 °C ... +1768 °C
S *)	Pt10Rh-Pt	-50 °C ... +1664 °C
T *)	Cu-CuNi	-200 °C ... +400 °C
B *)	Pt30Rh-Pt6Rh	+250 °C ... +1820 °C
C		0 °C ... +2320 °C

*) Thermocouples based on IEC 584 / EN 60584
Other thermocouples available upon request.

Relay modules with mounted miniature switching relays

The JUMPFLEX® product family is rounded out by the relay modules that fit perfectly with the transducers.

A logical enclosure concept with options for linking all levels offers a variety of synergy and cost-savings potential. This allows for efficient optimization of installation efforts.

The pluggable relays can be replaced quickly and easily when required.



For further information about the relays go to pages 10 - 12.

WAGO Relay Modules

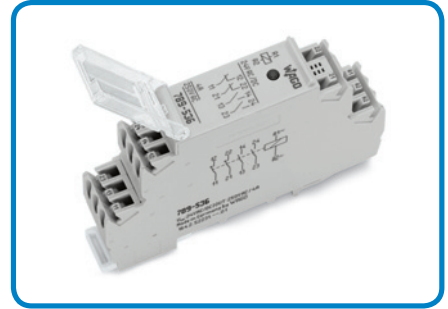
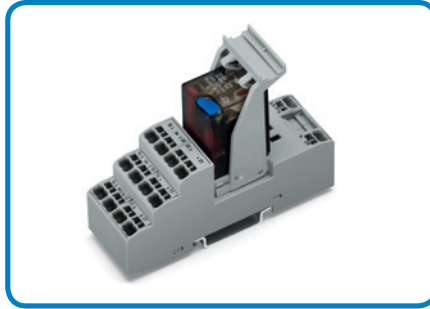
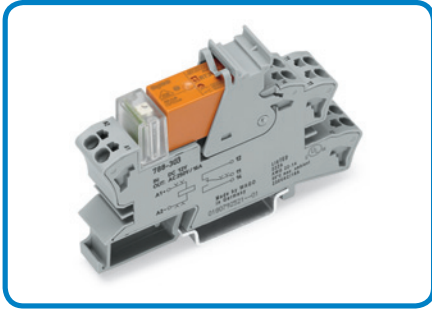

WAGO Relay Modules. The professional interface between electronics and peripheral equipment.

Even in modern automation systems, electromechanical relays guarantee a safe connection between process control systems and process and signalling systems. They provide:

- a high isolation level between input and output circuit
- ability to match different signal levels
- signal amplification and/or signal multiplication, especially for different potentials in the input and output circuits.

Modernized relays also offer the following advantages:

- unaffected by electromagnetic fields and surges
- high short-term overload capacity for the input and output sides
- small switching power losses
- a module for switching of AC or DC

WAGO AUTOMATION offers a complete range of relay modules that provide these functions for a wide range of applications.

Depending on the function and operating conditions, the relay modules are available with different contacts, contact materials, housings and shapes.

The following relay types are also available: bistable switching relays, time-delay relays, current pulse switching and safety relays with force-guided contacts.

Definitions of several important technical terms

Coil-side information

The relays can be used within the stated temperature range with nominal voltage plus tolerance at 100% continuous duty rating.

According to the type and application, the relays are triggered with DC or AC signal.

The DC versions (residual ripple $\leq 6\%$) are, unless otherwise stated, equipped with LED function indicators, a recovery diode and a reverse voltage protection diode.

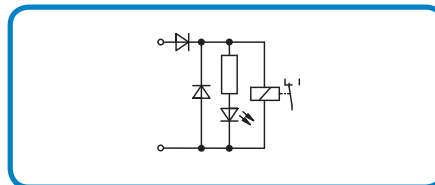

For a nominal voltage of $\leq 12\text{VDC}$, the LED is connected in parallel to the coil.

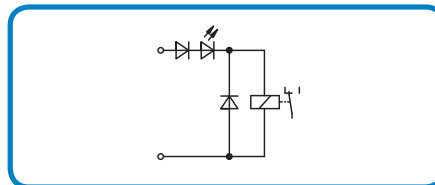

For a nominal voltage $\geq 24\text{VDC}$, the LED is connected in series with the coil.

AC versions of select relays equipped with series connected rectifiers (refer to the wiring diagrams) can be triggered with AC and DC at the stated nominal voltage.

The free-wheel function is in this case actuated by the rectifier.

In order to guarantee a safe operation it has to be observed that "residual voltages" due to cable capacitance in case of long connecting lines or leakage currents of semi-conductor switches and their protection circuits are lower than the release voltage of the relay.

For DC relays, the release voltage is specified with a value of $\leq 5\%$ of the nominal voltage; for AC relays it is 15% of the nominal voltage (acc. to VDE 0435).

If a high residual voltage exists, it is possible that the relay will not reset.

Addition of a parallel connection of an RC element of:

$$R = 100\text{-}220\Omega$$

$$C = 220\text{-}470\text{nF}$$

could remedy this situation.

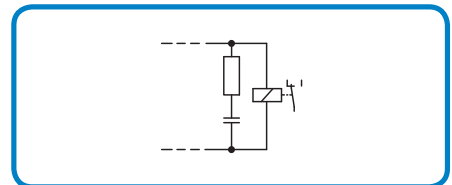

Alternatively, the 286-904 relay module is available.

This specially developed module features a defined release point at $110\text{VAC} \pm 10\%$ at an operating voltage (coil voltage) of 230VAC .

Contact material

To ensure a long service life and low contact resistance, various materials may be used for relay contacts (depending on the load type, switching current, voltage and duty cycle).

Possible materials, their properties and advantages are shown in the table.

Contact material	Properties and use	Range of values
Ag Ni 0.15 + 5 μ Au	High corrosion resistance, low and constant contact resistance at small power ratings, for dry circuits	μ V ... 30 V μ A ... 0.2 A
Ag Ni plated with Au Ag + Au	Same properties as a 5 μ gold contact, however with five times greater resistance to wear, for all circuits from the μ W range up to 100 W/1 kVA	100 mV/10 μ A
Ag Cd 0 + 1 μ Au	Low tendency to contact weld, high resistance to contact burn-out at higher power rating, also suitable for lower power ratings	\geq 5 V \geq 10 mA
Ag Cd 0, with gold flash	Low tendency to contact weld, high resistance to contact burn-out at higher power rating, with gold flash for additional protection during storage	\geq 12 V \geq 100 mA
Ag Ni 0.15 + HV	High mechanical strength, low tendency to contact weld and low contact resistance, universal application at medium loads	\geq 12 V 5 mA - 10 A
Ag Sn O ₂	Small tendency to contact weld, high resistance to contact burn-out at higher power rating, small migration of material, for circuits with high input and output ratings, DC circuits	\geq 5 V/100 mA \geq 10 V/10 mA \geq 24 V/1 mA
Ag alloy, with gold flash	High mechanical strength, small tendency to contact weld, wide scope of application for low to medium ratings	10^{-3} W

Contact switching protection

When switching inductive loads (e.g., for contractors or solenoid valves) transients with peak voltages up to thousands of volts will arise.

Suppression is necessary as these transients frequently exceed admissible EMC limits.

Moreover, they cause electric arcs at the switching contact that destroy the contact and significantly reduce the relay's service life and functional safety.

In practical use the following switching protections, which are connected directly at the source in parallel to the load, have proved to be efficient:

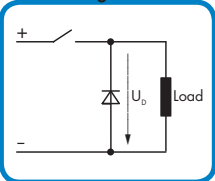
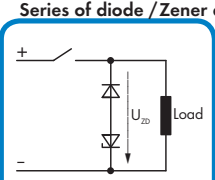
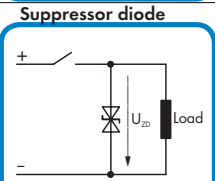
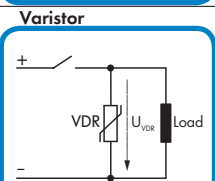
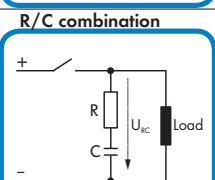
Switching of load	Additional off-delay	Defined limitation of inductive voltage	Attenuation when used with bipolar circuits	Advantages / disadvantages
Circulating diode 	large	yes (V_D)	no	Advantages: <ul style="list-style-type: none"> simple device cost-effective, reliable sizing not critical small inductive voltages Disadvantages: <ul style="list-style-type: none"> limit only via load resistance longer turn-off time
Series of diode / Zener diode 	medium to small	yes (V_{ZD})	no	Advantages: <ul style="list-style-type: none"> sizing not critical Disadvantages: <ul style="list-style-type: none"> limits only above V_{ZD}
Suppressor diode 	medium to small	yes (V_{ZD})	yes	Advantages: <ul style="list-style-type: none"> cost-effective sizing not critical limitation of positive peaks suitable for alternating voltages Disadvantages: <ul style="list-style-type: none"> attenuation only above V_{ZD}
Varistor 	medium to small	yes (V_{VDR})	yes	Advantages: <ul style="list-style-type: none"> high energy absorption sizing not critical suitable for AC voltages Disadvantages: <ul style="list-style-type: none"> attenuation only above V_{VDR}
R/C combination 	medium to small	no	yes	Advantages: <ul style="list-style-type: none"> limiting by energy storage suitable for alternating voltages limiting independent of level Disadvantages: <ul style="list-style-type: none"> exact component values high turn-on current pulse

Service life

The difference between mechanical life and electrical life must be distinguished. Mechanical life consists of the amount of switching operations without contact load; electrical life at maximum load refers to the amount of switching operations with maximum switching capacity and resistive load.

Smaller switching capacities increase the operation at maximum load. The following illustration shows the typical course between switching current and relay's operational life.

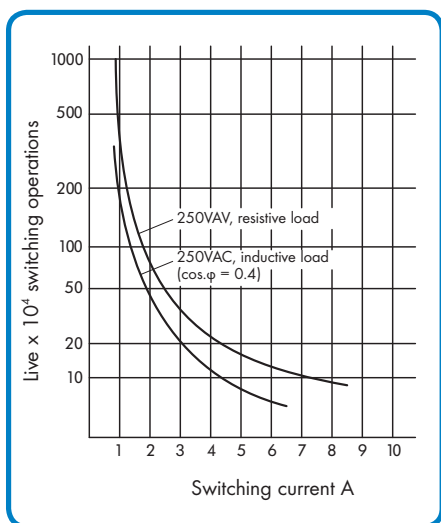

More details upon request.

Description of select relays

Bistable switching relays

Bistable switching relays have 3 coil contacts. According to the wiring scheme, the relay is switched into "working condition" (contacts 11 - 14 closed) by the common connection A 3 and the connection A 1 and into "rest position" (contacts 11 - 14 opened) by the connection A 2.

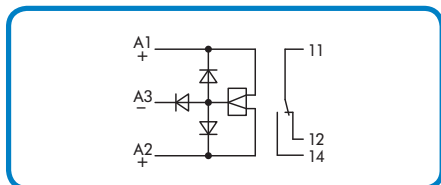

After removing the control signal, the relay returns to its respective position and can only be switched over by a control signal circuit. The bistable switching relays are only available for direct voltage with positive or negative triggering.

Current pulse switching relay

One current pulse is needed to change the relay from the rest position to the working position and vice versa.

During the triggering process, one of two status indicators displays the actual contact position. The current pulse switching relay is available for direct and alternating voltage.

Safety relay

Force-guided safety relays, have become increasingly recommended and specified for self-regulated systems as they provide protection for personnel, machines and installations. Relays with force-guided contacts are an essentially safety component for these circuits, particularly when defects occur. WAGO offers these functions in special relay modules with force-guided contacts as based on to ZH1/457

(Specification of the employer's liability insurance association).

Example of circuit configuration:

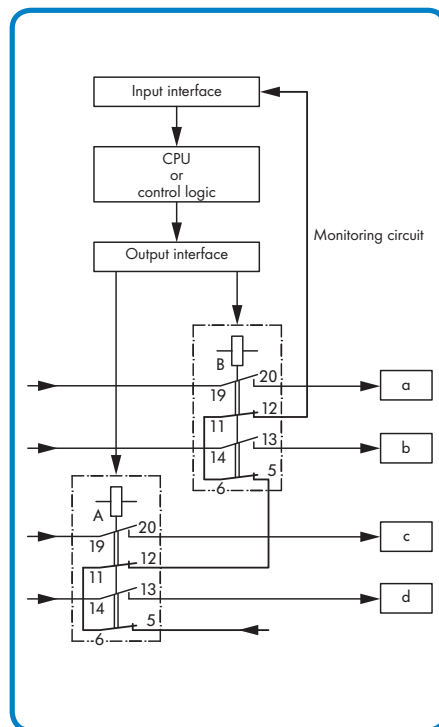

Control of different peripheral equipment (a, b, c, d) with monitoring

As shown in the fig. "Example of Circuit Configuration," two SF relays are controlled by one output interface. The NO contacts 13 - 14/19 - 20 of relay A and B switch over the peripheral equipment. After switching off equipment a ... d the control circuit (NC contacts 5 - 6/11 - 12) verifies that all main circuits are interrupted.

When the control circuit is closed, the next operation cycle will be executed by the CPU or by the control logic. Depending on the safety requirements, an open control circuit prevents operation of either the entire machine or specified components.

If a partial or complete standstill is required in the event of a failure (for ex. in medical technology or chemical processes) each control contact can be polled and evaluated.

Independent of a single or complete control for the NO contact, the SF relay operates in such a way that the other equipment is switched off even if a NO contact is welded. The failure is recognized by the control contact while the other contacts are still able to open to interrupt circuits.

Time delay relays

WAGO time delay relay modules are electromechanical time relays with an integrated time response, e.g., acc. to VDE 0435, part 201/5.83. The time ranges can be adjusted via potentiometer for either continuously variable or linear operation. A status LED indicates the switching condition of the relay.

WAGO optocouplers: the modern and efficient alternative

As the connecting element between process interface and electronic control and signalling systems, the optocoupler modules offer the following advantages compared with mechanical relays:

- long service life, because there is no mechanical wear
- high switching frequency because of fast switching times
- unaffected by vibration
- no contacts
- "noiseless" switching
- low driving capacity.

For all interfaces between control and load circuits that rely on these advantages, WAGO AUTOMATION offers a complete optocoupler range for the following functions:

- electrical isolation between input and output circuit
- adaptation to different signal levels
- signal amplification.

The optocoupler modules are available in WAGO's component plug technology that is designed to plug directly into rail-mounted carrier terminal blocks.

The terminal blocks are fitted to the carrier rail and offer all advantages of CAGE CLAMP® technology, which provides safe and maintenance-free connection of the signal wires for cross sections ranging from 0.08 mm² to 2.5 mm²/ AWG 28-12.

In addition to optimizing space through the combination of terminal points and the "function module," maximum flexibility and ease of service are also achieved.

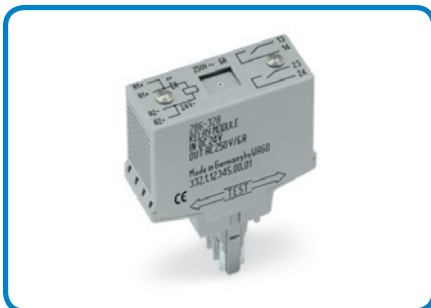

Input circuit

According to the type, triggering the optocoupler modules is performed via direct voltage (residual ripple RR <6%) or AC voltage (50-60 Hz).

In the DC type, a reverse voltage protection diode is always provided; in the AC type optocoupler element, a rectifier is included.

The optocoupler modules are equipped with a LED function indication at either the input side or at the load side, as shown in the wiring diagram.

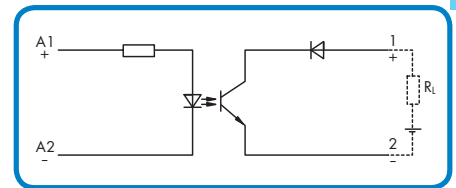

2-wire output

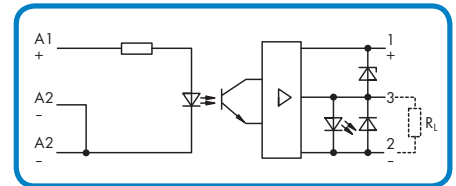

3-wire output positive switching

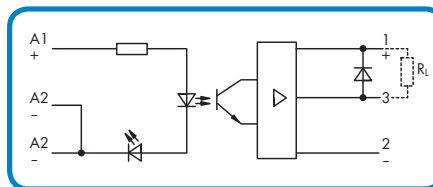

DC triggering with LED function indication in the triggering circuit

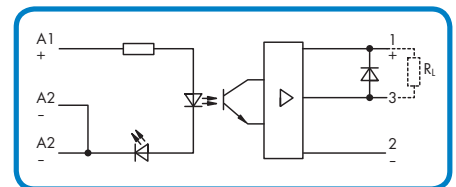

3-wire output negative switching

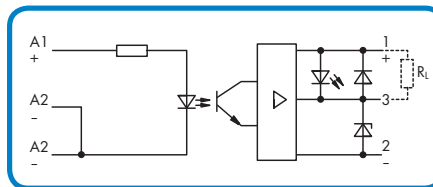

DC triggering with LED function indication in the load circuit

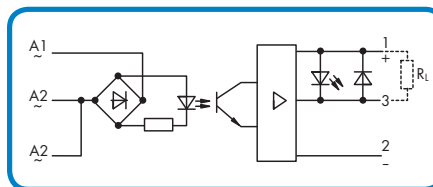

AC triggering with LED function indication in the load circuit

In addition to these different functional outputs, the output voltage range and the maximum switching current must be observed. Also note the correct polarity. In order to protect the output transistors, inductive loads must always be equipped with a protective circuit, e.g., a recovery diode. For other types of protective measures, the cut-off voltage peaks must be lower than the indicated cut-off voltage of the output transistors. For the AC outputs a Triac is used as the switching element.

Due to the low threshold voltages, care must be taken to ensure malfunctions are not caused by the capacitance of long signal lines or the residual off-current of semiconductor devices.

Output circuit

Depending on the application, an optocoupler module for the AC or DC supply may be chosen. In the case of DC outputs, they can be:

- 2-wire output
- 3-wire output positive switching
- 3-wire output negative switching.

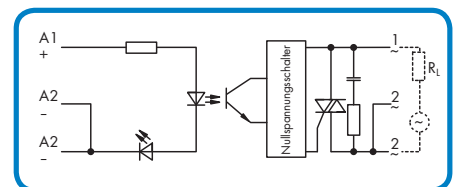

In order to avoid high turn-on currents, the AC output is equipped with a zero-voltage switch which turns on the load at the zero-voltage point. In the current zero-crossing, the Triac will cut off the load, in case inductive loads do not exceed the maximum switching voltage and the maximum switching current.

Transducers for measurement technology

The Recording and processing of numbers of physical values, such as temperature, pressure, speed, humidity, etc., form the basis for modern process control. Special sensors supply these values as analog signals, which must be transmitted as standard analog signals to the processing instruments. These analog signals may be transmitted over long or short distances between sensors and controlling mechanisms, for example PLCs and computers, or in less sophisticated systems directly to relays or actuators. Various standards are used. Normally recognized signals are 0-10 V, 0-20 mA and 4-20 mA.

The transducer/transmitter may also linearize non-linear signals internally, before transmission. In order to prevent these relatively low power signals from distortion, WAGO AUTOMATION offers a complete range of modules for measurement and transmission of these signals, both with and without isolation between the module's input/output and the supply voltage (if necessary). Apart from the converters for various standardized signals, WAGO offers a complete selection of analog/digital and digital/analog converters with a resolution of 10 bits.

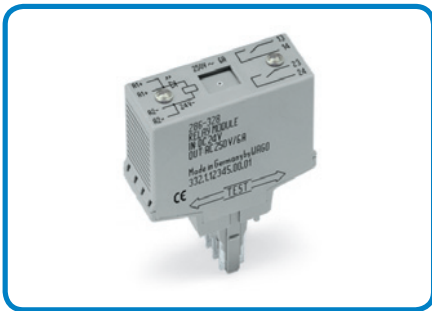

The electronics are protected by an enclosure which can be snapped on a DIN 35 rail. The CAGE CLAMP® connection ensures a secure, maintenance-free connection for conductors sized from 0.08 mm² to 2.5 mm²/AWG 28-12.

Temperature transducers

Temperature sensing in the process industry is traditionally performed via "Thermocouple" or "RTD" (Platinum Resistance) elements. A popular RTD is the Pt100 element. Having a nominal resistance of 100 ohm at 0°C, and a typical operating temperature range of -200°C to + 650°C, its non-linear characteristics are compensated by the WAGO signal conditioning module, as the Pt100 element typically meets the IEC 60571 specification.

The WAGO Pt100 signal conditioning module is suitable for 2- or 3-wire RTD, with 3-wire RTDs offering greater accuracy over longer distances. Thermocouples consist of two different metals that are connected at the measuring point and utilize of the "Dissimilar Metal (EMF) effect", which can be measured at the open ends of an element.

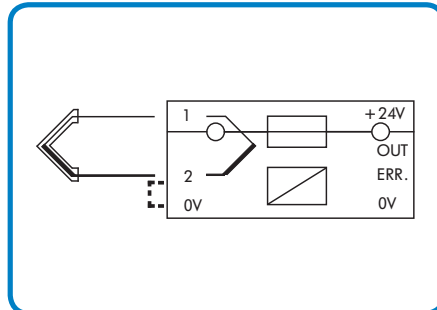

- When using insulated thermocouples, terminal "2" has to be connected to 0 V.
- In the case of grounded (earthed) thermocouples, the design is such that terminal 2 is already connected to 0 V inside the thermocouple element. Therefore, it is not necessary to jumper 2 → 0 V.
- For commoning 2 → 0 V, 4-wire base terminals are recommended.

WAGO analog signal conditioning modules are designed to work with common types of "J" (Iron/Constantan) and "K" (Chromel/Alumel) thermocouples, which comply with IEC standard 60584 Pt. 1, with cold junction compensation. WAGO temperature transducers are available with industry standard output signals of 0-10 V, 0-20 mA or 4-20 mA.

Additionally, they have an integral wire break/short circuit detection. Visual LED fault indication is standard, but the WAGO modules also include an error output signal that may be used to initiate a safe shutdown before serious damage occurs in the event of a wire break or short circuit of the measuring sensor.

For this purpose, a transistor switches the output as soon as the operating voltage is correct and no error is present in the measuring circuit on VB-2V. The transistor blocks the output in the case of an error.

WAGO temperature transducers are available as follows:

- The "wire break" and "short circuit" error output is available on the Pt100 module.
- The "wire break" function is available on the J and K Thermocouple modules.

In the event of wire break, the outputs switch to the following values:

Output	Value
0(4)-20mA	≥20.5mA
0-10V	≥14V

With Pt100 modules, and in case of short circuit, the outputs switch to 0V or 0mA, respectively.

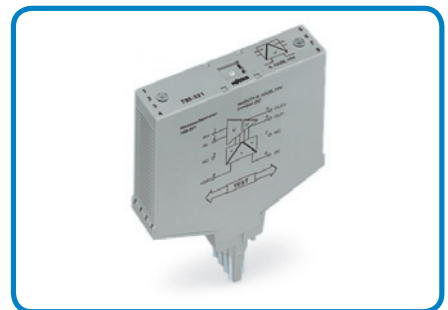

The mechanical assembly of pluggable modules for rail-mounted terminal blocks on DIN 35 rails offers all the advantages of CAGE CLAMP® connectivity. Additionally, the separation of wiring and function levels offer maximum flexibility and ease of service.

WAGO Interface Modules

Interface modules connect electronic to electromechanical functions at the control level.

They connect:

- signal transmission, control system ↔ field
- signal distribution, control system ↔ field.

They allow prefabricated plugs to interface to discrete field wiring.

WAGO AUTOMATION offers a wide range of interface modules for commonly used connector types. The use of these interface modules offers the following advantages in the system wiring:

- easy and time-saving planning and calculations
- rapid wiring, starting and fault elimination by clearly arranged wiring and clear pole marking, reduction of wiring faults
- safe and maintenance-free connection of the signal lines with the CAGE CLAMP® terminal strips
- high packing density creates space-saving modules

The interface modules are standard in a universal mounting carrier for DIN 35 carrier rails with the following connectors:

Subminiature-D connectors acc. to DIN 41 652 or MIL-C-24308

Interface modules for male and female connectors are available with 9, 15, 25, 37 or 50 contacts. Compared with the standard solder connection, the mating connector with IDC connection offers additional advantages.

Connectors acc. to IEC 60603/DIN 41 612, types C, E and F

These connectors are frequently used for compact input and output component groups and are available for 32-, 48- and 64-pole pin and socket connectors, as well as for mating connectors with solder and IDC contacts.

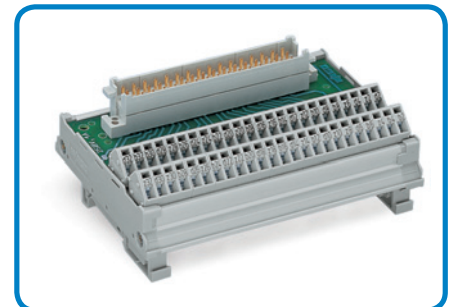

Ribbon cable connectors acc. to IEC 60603-1 / DIN 41 651 or MIL-C-83503

Interface modules with 10-, 14-, 16-, 20-, 26-, 34-, 40-, 50- and 64-pole connectors are available for ribbon cable connectors.

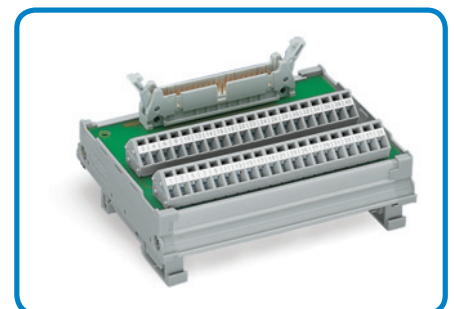
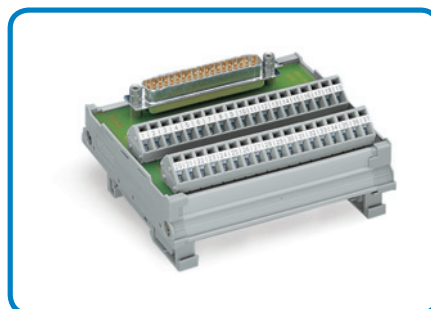

WAGO EPSITRON – 787 Series

High-Performance and Efficient Advanced Power Supplies

PRO Power Supplies

Slimline, 1- and 3-phase, primary switch mode power supplies feature a wide input voltage range, stabilized, adjustable 24VDC output voltage and up to 93% high efficiency. An integrated Power-Boost (up to 200 % output power for 4 seconds) allows reliable starting of heavy loads with high inrush currents, eliminating expensive oversizing of the switch mode power supply. The TopBoost function, which provides a much higher output current of up to 60A for 50ms, permits use of standard circuit breakers for protection on the secondary side. This enables safe tripping within the time limits required by the EN 60204 standard.



Select devices utilize the LineMonitor feature for current and voltage monitoring, fault memory and parameterization options via LCD display, on-unit function keys, or free monitoring software and available RS-232 interface from a PC and PLC. This allows the power supply to replace additional devices, such as phase failure and phase sequence monitoring devices or operational hour meters.

Additionally, the single-phase power supplies have a stand-by mode to switch off the device output via remote input, while minimizing power consumption. CAGE CLAMP® pluggable terminations permit efficient pre-wiring.



CLASSIC Power Supplies

Single-phase, primary switch mode, industrial power supplies provide a wide input voltage range and robust metal housings. The CLASSIC Power Supplies have a stabilized, adjustable output voltage and provide short-circuit and overload protection. The devices achieve high efficiency and the integrated LED status indicator conveniently provides operational status at a glance. CAGE CLAMP® pluggable terminations permit efficient pre-wiring.

The CLASSIC Power Supplies are available in four nominal output voltages: 12VDC, 24VDC or 48VDC, as well as 30.5VDC for AS-Interface networks.



Rail-Mounted Modules – Constant Voltage Sources

Constant voltage sources provide stabilized 24VDC voltage via integrated longitudinal voltage regulator. CAGE CLAMP® provides fast, vibration-proof and maintenance-free terminations. The modules are DIN-rail mountable.



ECO Power Supplies

Single-phase, primary switch mode power supplies in sturdy metal housing offer a wide input voltage range from 90 to 264VAC, without manual switching. The stabilized, front-panel adjustable 24VDC output voltage is protected against open and short circuits, and constant current operation is provided in the overload range. LEDs quickly provide operational status at a glance. CAGE CLAMP® provides fast, vibration-proof and maintenance-free terminations.



Rail-Mounted Modules – Power Supplies

Conventional transformer power supply with bridge rectifier, smoothing capacitors and stabilized output voltage via longitudinal voltage regulator. This power supply is ideal for supplying small loads with nominal output voltages of 24VDC, 12VDC, ± 12 VDC and ± 15 VDC. The low residual ripple makes the units well suited to applications using analog technology. CAGE CLAMP® provides fast, vibration-proof and maintenance-free terminations. The modules are DIN-rail mountable.



Electronic Circuit Breakers

Configurable protection via 4-channel electronic circuit breakers, for shutting down faulty 24VDC current paths. Offering adjustable trip times, the Electronic Circuit Breakers can respond to short circuits/overloads quicker than traditional circuit breakers or melting fuses, or when unintended start-ups must be prevented in the event of a ground fault (see EN 60204). This is particularly advantageous when using long cables between a power supply and load where loop resistance may be very high. Integrated current and voltage monitoring, as well as parameter setting via display and on-unit function keys, or via free software from a PC or PLC, provides easy operation and diagnosis. Electronic circuit breakers with active current limitation (maximum 1.5 times rated current) are also available as an option. These advanced features enable the Electronic Circuit Breakers to reliably prevent voltage drops in the event of a short circuit.



DC/DC Converters

DC/DC converters available in 6.2mm-wide terminal block housing or DIN-rail mount carrier. These converters are ideal for applications where it is not necessary to use a separate power supply with special voltage due to low power requirements (e.g., when supplying sensors, actuators or DALI bus devices).



Uninterruptible Power Supplies (UPS)

The Uninterruptible Power Supply (UPS) provides reliable power applications impacted by long-term power outages. The UPS consists of a charger, controller and a connected battery (capacities ranging from 3.2 to 12 Ah are available). In battery operation, 24VDC can be provided for several hours depending on the load current and battery capacity. The charger and controller are supplied with 24VDC from an external power supply – capacity must be matched to the load. Operation, configuration and diagnosis are simplified by an integrated LCD with keypad, or free software using an RS-232 interface (for connection to a PC or PLC). The battery modules have a temperature sensor NTC 164 (4k7 Ω), allowing for temperature-controlled charging via charger and controller, which may extend the battery's service life.



Redundancy Module

The redundancy module has two integrated power diodes (2 x 20A) for parallel connection of power supplies, while improving power supply availability or increasing the total current (max. 40A) for the 24VDC loads. A signal contact reports the failure of one or both input voltages, which is also displayed via LED.



Capacitive Buffer Modules

Capacitive buffer modules ensure smooth operation and protect data during shorter 24VDC power interruptions. Depending on the output current and buffer capacity, buffer times up to several seconds can be achieved. Control units are particularly sensitive to short power interruptions. This is why an integrated signal contact reports buffer operation, offering the control unit sufficient time for preventive measures (e.g., saving valuable production data or program parameters).



Communication Cable

The communication cable connects the RS-232 interface for power supplies with integrated LineMonitor (787-85x) and electronic circuit breakers (787-86x), as well as UPS charger and controller units (787-87x) to the RS-232 interface of a PC or PLC. When combined with free software, the cable provides easy parameterization and diagnostics for these WAGO power supply solutions.



WAGO Overvoltage Protection

WAGO overvoltage protection for increased safety and longer on-line operation

On-the-line overvoltages cause most operating failures for measuring, control, data and power lines. Failure of electronic and semiconductor components due to surges can cause operating interruptions. The overvoltage (also called transients) can be generated by switching electrical equipment on or off or by lightning discharges. Devices designed to protect electrical equipment from these voltages are called SPDs (Surge Protection Devices). SPDs may consist of either a single component or a combination of them. Various components may be subdivided in use by the protection type offered:

- Coarse protection
- Medium protection
- Fine protection.

The boundaries between these levels of protection may not be sharply defined, leading the devices chosen to vary accordingly. The following components have proven performance in these applications:

Gas-filled surge arresters and spark gaps

The gas filled surge arrester is comprised of two electrodes in a ceramic or glass tube filled with a pressurized inert gas. A spark gap is simply two electrodes in air, spaced a predetermined distance apart.

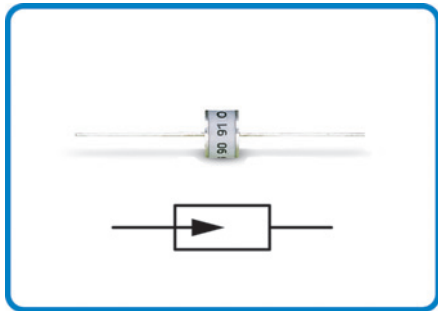

Once the ignition voltage is reached, resistance drops due to ionization and current begins to flow. The resistance of the device drops from high to low as it conducts. The voltage across the device after the arc is struck is typically 10 V ... 30 V. Therefore, the current will continue to flow until the voltage drops below this level. As this is not a guaranteed occurrence in typical power situations, a fuse must precede the device to ensure disconnection from the supply.

The advantage of a gas-filled arrester: high current carrying capacity for its size. However, the key disadvantages: slow response speed and in AC applications, the crowbar action across the supply.

Varistor

A varistor is a voltage-dependent resistor. A common type of varistor is referred to as an MOV (Metal Oxide Varistor) due to its method of construction.

Varistors have a very high resistance until their threshold voltage is exceeded. Then they drop to a low resistance and are capable of carrying high currents for a short period of time. They have a fast response time, and have a current carrying capacity dependent on the surface area of metal oxide material. MOVs can be sized to handle currents exceeding of 100 kA.

Undersized varistors can age with continued

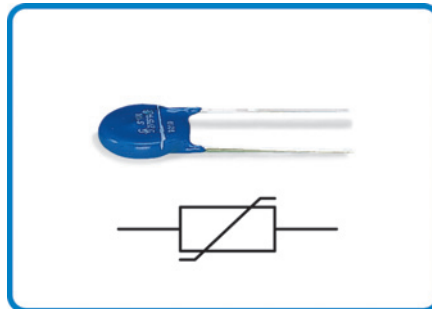

surge conduction, resulting in lower impedance and higher leakage.

When subjected to continuous (AC or DC) voltages in excess to the device rating, MOVs can overheat, and even explode, in certain circumstances. This is why a quality surge protection device is important, it will incorporate protective measures to disconnect faulty components before safety is compromised.

Suppression diode (or silicon avalanche diode)

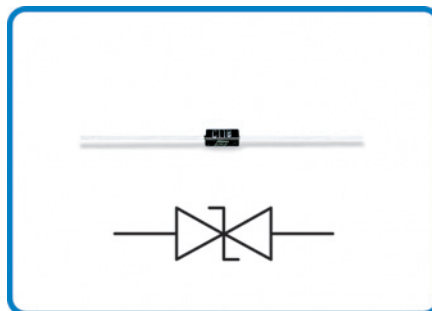

These devices have electrical characteristics similar to Zener diodes, but are rated for surge currents.

Once the rated breakdown voltage is exceeded (in the non-conductive direction), the diode becomes a conductor. The suppression diode differs from a Zener in its higher current carrying capability and faster response time (in the picosecond range).

Test impulse

Surge arresters are subject to standardized test pulses in order to classify capabilities; the effectiveness of protection measures with reference to dissipation capacity and voltage arresting. The form and level of the test pulses are defined by IEC 60060-1/DIN VDE 0432, part 2. Preference is given to voltage pulses of 1.2/50 and current pulses of 8/20.

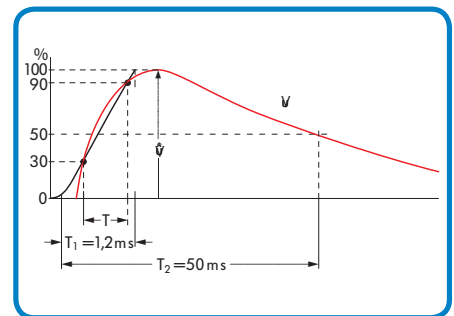

Voltage pulses 1.2 / 50
per IEC 60060-1 / DIN VDE 0432 P. 2

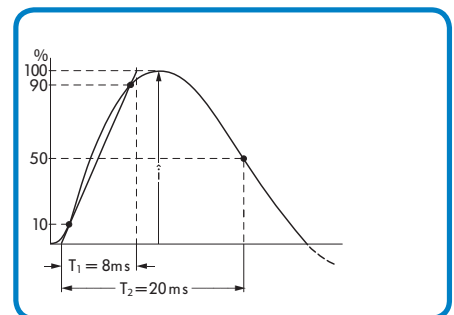

Current pulses 8 / 20
per IEC 60060-1 / DIN VDE 0432 P. 2

Application recommendations

The advantages of gas-filled surge arresters lie in their high current carrying capacity, making them ideal for coarse protection. One disadvantage, particularly in the medium protection range, is the relatively long response time, as well as the power follow current. Varistors have a considerably shorter response time; however they also have lower leakage currents. This makes them more suitable for medium protection, as they offer limited applications for coarse protection. If the connection lines of electronic equipment are already "fine" protected, general coarse and medium protection measures are sufficient. If this is not the case, suppressor diodes with very short response time may be employed as fine protection.

WAGO AUTOMATION offers a complete range of modular terminal blocks with integrated surge arresters for coarse, medium and fine protection.

Depending on the application, one can choose the appropriate type from the previously mentioned surge arresters. These are electrically connected in the modular terminal blocks between the connection point and the mounting rail. Snapping the terminal block onto the grounded (earthed) mounting rail automatically ensures the required overvoltage protection.

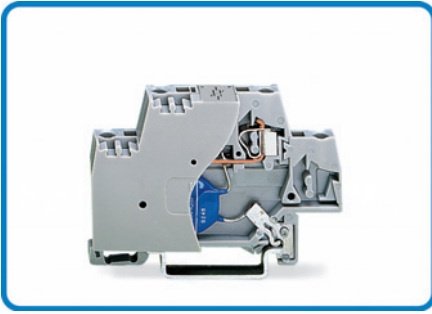

Double-deck terminal block with varistor, direct connection to the DIN 35 rail

Frequently, only one surge arrester is fitted for cost reasons. However, due to the fact that one surge arrester alone cannot optimally ensure several protection functions, combinations are recommended. Care must be taken to ensure that the single-stage protection devices are decoupled sufficiently by inductors or resistors.

In addition to single-stage surge arresters, WAGO AUTOMATION also offers multi-stage surge arresters, combining components for different applications. These pluggable modules are snapped into "carrier" terminal blocks. These are DIN rail-mounted and offer secure and maintenance-free CAGE CLAMP® terminations for conductors 0.08mm²/AWG 28 to 2.5mm²/AWG 14.



Pluggable surge suppression modules with on-unit warnings

Addition of interference suppression to surge suppression devices. In addition to overvoltage protection, a high frequency interference filter can be added to the circuitry. This filter cannot only protect the equipment from high frequency energy transmitted by connecting wires, but also prevents a transmission of disturbances to the supply lines. The main component of a filter is an LC network, which produces a mismatch between the filter impedance and the impedance of the disturbance path. This reflects any disturbance back to its source.

Definition of several important technical terms

Nominal operating voltage (V_{BN})

The nominal operating voltage corresponds to the voltage which may be permanently connected to the appropriate connection terminals of the overvoltage protection module. Alternating voltages are quoted as effective values.

Max. operating voltage (V_{Bmax})

The maximum operating voltage corresponds to the voltage which may be permanently connected to the appropriate connection terminals without the operating properties changing or activating the individual module's protection elements.

Nominal current (I_N)

The nominal current corresponds to the current which may permanently flow through the connection terminals of the overvoltage protection device.

Nominal discharge current (I_{SN})

The nominal discharge current is the maximum value of a current having the 8/20 μ s waveform (DIN VDE 0432/10.78 part 3), which can flow through the surge arrester five times within a time period of 30 seconds (VDE) without destroying it.

Max. surge current (I_{Smax})

The maximum surge current I_{Smax} defines the maximum value of a current having the 8/20 μ s waveform, which can flow through the surge arrester once without destroying it.

Protection level

The protection level is the value of the residual voltage occurring on the "protected" side of the surge arrester when applying the rated discharge current.

Response time (t_{an})

The response time is primarily based on the physical properties of the surge arresters and is dependent upon the wave front duration of the surge voltage. WAGO's data refers to a voltage rise of 1kV/ μ s.

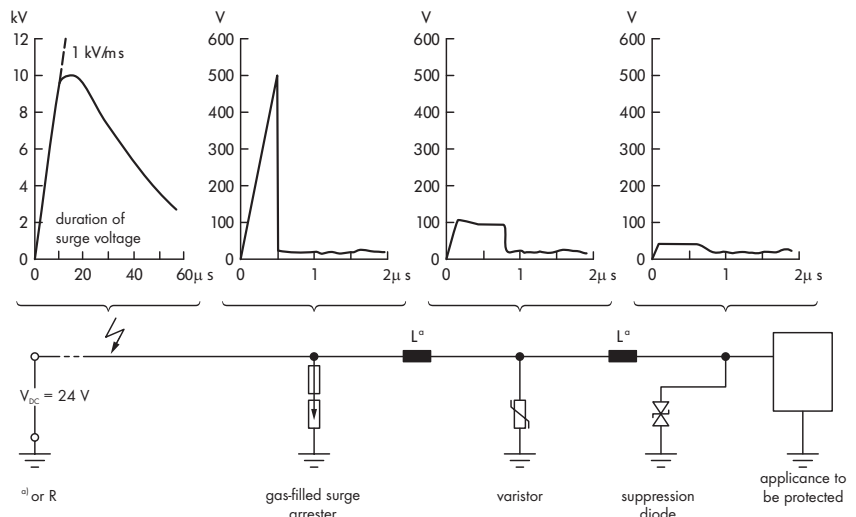

Function diagram of a multi-stage surge voltage protection module

Overview: Relay Modules

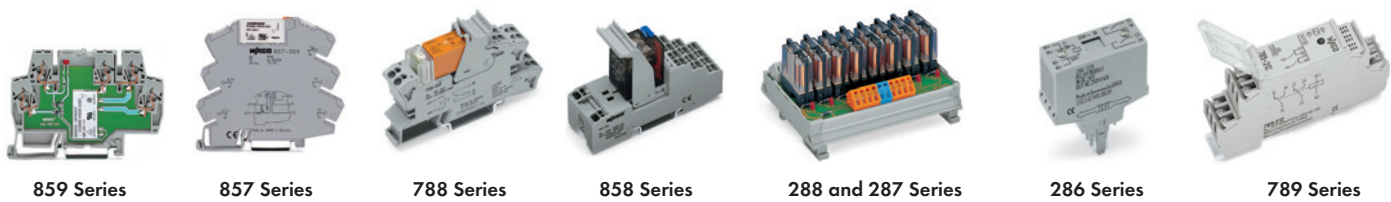



Relays with Changeover Contacts

Nominal voltage	5 V		12 V		24 V		48 V		60 V		115 V		230 V	
1 changeover contact	Item No.	Page	Item No.	Page	Item No.	Page	Item No.	Page	Item No.	Page	Item No.	Page	Item No.	Page
DC	859-302	32	859-303	32	859-304	32	859-305	32	859-306	32	859-307	32	859-308	32
	286-302	101	857-303	50	859-314	33	857-305	50	857-306	50	859-317	33	859-318	35
AC			788-303	64	859-390	36	788-305	64	788-306	64	859-391	37	857-308	50
			286-303	101	859-398	37	286-305	101	286-306	101	857-307	50	857-318	50
AC/DC			287-853	93	859-392	38	286-395	102			857-317	50	286-308	101
					857-304	50					788-307	64		
					857-314	50					286-307	101		
					788-304	64								
					788-404	66								
					788-324	68								
					788-354	70								
					788-374	73								
					286-304	101								
					286-394	102								
					286-380	109								
					286-381	109								
					288-304	89								
					287-774	91								
					287-804	92								
					287-824	92								
					287-854	93								
					288-380	95								
					789-304	140								
							788-506	65			859-360	34	859-359	34
											859-367	35	859-368	36
											788-507	65	788-508	65
											788-607	67	788-608	67
											286-507	101	788-528	69
													286-508	101
													286-904	108
													288-508	89
													288-762	90
													789-508	140
	286-502	101	859-353	32	859-354	32	859-355	32	286-506	101	859-357	32	859-358	32
			286-503	101	857-354	50	286-505	101			857-357	50	857-358	50
					857-364	50					857-367	50	857-368	50
					286-504	101					288-761	90		
					286-594	102								
					288-554	89								
					288-504	89								
					288-758	90								
					287-814	92								
					287-834	92								
					789-504	140								
Nominal voltage	5 V		12 V		24 V		48 V		60 V		115 V		230 V	
2 changeover contacts	Item No.	Page	Item No.	Page	Item No.	Page	Item No.	Page	Item No.	Page	Item No.	Page	Item No.	Page
DC	286-310	103	788-311	64	788-312	64	788-313	64	788-314	64	788-315	64	286-316	103
			286-311	103	788-412	66	286-313	103	286-314	103	286-315	103		
AC					788-334	68	789-313	141			789-315	141		
					788-384	72								
AC/DC					788-375	73								
					286-312	103								
					286-384	107								
					288-312	90								
					288-437	96								
					789-312	141								
	286-510	103	286-511	103	788-512	65	286-513	103	286-514	103	788-515	65	788-516	65
					286-512	103					788-615	67	788-616	67
											286-515	103	788-538	69
											789-515	141	286-516	103
													789-516	141
							288-512	90						
							789-512	141						
Nominal voltage	5 V		12 V		24 V		48 V		60 V		115 V		230 V	
4 changeover contacts	Item No.	Page	Item No.	Page	Item No.	Page	Item No.	Page	Item No.	Page	Item No.	Page	Item No.	Page
DC					858-304	82								
					858-314	82								
AC					286-375	106								
											286-578	106	858-508	83
													858-518	83
													286-579	106

Relays with Make Contacts

Nominal voltage	5 V		12 V		24 V		48 V		60 V		115 V		230 V	
1 make contact	Item No.	Page	Item No.	Page	Item No.	Page	Item No.	Page	Item No.	Page	Item No.	Page	Item No.	Page
 DC					286-364	100			286-365	100				
					788-355	71								
					288-364	88								
AC					288-320	94								
AC/DC					287-475	94								
					287-474	94								
					789-571	144								
					286-376	107								
					286-564	100					286-566	100	286-567	100
													789-570	144
					288-564	88			288-565	88			288-567	88

Nominal voltage	5 V		12 V		24 V		48 V		60 V		115 V		230 V	
2 make contacts	Item No.	Page	Item No.	Page	Item No.	Page	Item No.	Page	Item No.	Page	Item No.	Page	Item No.	Page
 DC	286-326	104	286-327	104	286-328	104	286-329	104	286-330	104			286-332	104
AC														
AC/DC														

Nominal voltage	5 V		12 V		24 V		48 V		60 V		115 V		230 V	
4 make contacts	Item No.	Page	Item No.	Page	Item No.	Page	Item No.	Page	Item No.	Page	Item No.	Page	Item No.	Page
 DC	286-350	106	286-351	106	286-352	106	286-353	106	286-354	106	286-355	106		
					789-352	143								
					286-552	106					286-555	106	286-556	106
AC														
AC/DC			789-551	143	789-552	143								

Relays with break contacts and make contacts

Nominal voltage	5 V		12 V		24 V		48 V		60 V		115 V		230 V	
1 break contact	Item No.	Page	Item No.	Page	Item No.	Page	Item No.	Page	Item No.	Page	Item No.	Page	Item No.	Page
 DC					286-368	100	286-369	100	286-370	100				
					286-568	100								
AC														
AC/DC					288-568	88								

Nominal voltage	5 V		12 V		24 V		48 V		60 V		115 V		230 V	
1 break contact/ 1 make contact	Item No.	Page	Item No.	Page	Item No.	Page	Item No.	Page	Item No.	Page	Item No.	Page	Item No.	Page
 DC	286-318	104	286-319	104	286-320	104	286-321	104	286-322	104			286-324	104
					286-906	108								
					286-571	109								
AC					286-520	104							286-570	109
AC/DC														

Nominal voltage	5 V		12 V		24 V		48 V		60 V		115 V		230 V	
2 break contacts/ 2 make contacts	Item No.	Page	Item No.	Page	Item No.	Page	Item No.	Page	Item No.	Page	Item No.	Page	Item No.	Page
 DC	286-334	105	286-335	105	286-336	105	286-337	105	286-338	105	286-339	105		
					789-336	142								
					286-536	105								286-540
AC														
AC/DC			789-535	142	789-536	142								

Nominal voltage	5 V		12 V		24 V		48 V		60 V		115 V		230 V	
1 break contact/ 3 make contacts	Item No.	Page	Item No.	Page	Item No.	Page	Item No.	Page	Item No.	Page	Item No.	Page	Item No.	Page
 DC	286-342	105	286-343	105	286-344	105	286-345	105	286-346	105	286-347	105		
					286-544	105					286-547	105	286-548	105
AC														
AC/DC														

Nominal voltage	5 V		12 V		24 V		48 V		60 V		115 V		230 V	
Safety relays 4 break contacts/ 4 make contacts	Item No.	Page	Item No.	Page	Item No.	Page	Item No.	Page	Item No.	Page	Item No.	Page	Item No.	Page
DC	288-412	97	288-413	97	288-435	96								
	288-422	97	288-423	97										
AC													288-418	97
													288-428	97
AC/DC					288-414	97	288-415	97	288-416	97				
					288-424	97	288-425	97	288-426	97				



286 Series

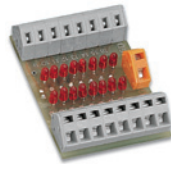

289 Series

Special Functions

Function		289 / 789 Series		286 Series	
		Item No.	Page	Item No.	Page
NAMUR Switching Amplifiers	with relay output 250 V AC / 120 V DC			286-880	126
	with transistor output 24 V DC			286-881	126
Current Flow Monitoring Modules	AC/DC 15 mA DC/35 mA ... 300 mA AC	Optocoupler		286-659	128
	AC 80 mA ... 6 A	Transformer		286-661	128
	AC 0.2 A ... 3 A	1 changeover contact		286-664	129
	AC 1 A ... 10 A	1 changeover contact		286-665	129
	DC 0.4 A ... 1.5 A	1 make contact		286-662	129
Switching Module	1-pole changeover	with changeover rocker switch		286-895	127
	Hand-0-Automatik Umschalter	with momentary switch		286-896	127
Bridge Rectifiers	230 V / 1 A AC			280-804/281-419	131
	230 V / 1 A AC	with varistor protection		286-840	130
	24 V / 1 A AC			286-830	130
Fuse Module for replaceable microfuses 5 x 20 mm	Operating voltage 24 V AC/DC	Blown fuse indication, LED green		286-890	132
	Operating voltage 230 V AC/DC	Blown fuse indication, neon lamp		286-891	132
Diode Gate Modules	common anode	3 diodes		286-803	133
		5 diodes		286-805	133
		7 diodes		286-807	133
		9 diodes		286-809	133
	common cathode	3 diodes		286-813	133
		5 diodes		286-815	133
		7 diodes		286-817	133
		9 diodes		286-819	133
Polarized Diode Gate	common anode	14 diodes	289-121	188	
	common cathode	14 diodes	289-111	188	
Open Diode Gate	with 8 diodes, individual connection possible	Diode 1 N 4007	289-101	186	
		Diode P 600 B	289-103	186	
	with 9 diodes, individual connection possible	Diode 1 N 5408	289-105	187	
AND Gate Module	with 6 inputs, relay output with 1 make contact			286-826	134
Flip-Flop Module	Operating voltage 24 V DC			286-825	135
LED Indicator Module	with 8 LEDs	common cathode		286-822	134
LED Gate Module	with 16 LEDs	common anode	289-202	189	
		common cathode	289-201	189	
Lamp Test Circuit	with 20 diodes for testing 10 lamps		289-151	189	
Open Resistor Gate	with 8 resistors, individual connection possible		289-114	190	
Resistor Gate	with 1 end commoned, 8 resistors		289-113	190	
Fault Indicator Modules, with reset	Auxiliary and fault indication voltage 230 V AC	Alarm with continuous light		286-681	136
	60 V DC	Alarm with continuous light		286-684	136
	24 V DC	Indication of original fault with single flashing light		286-683	137
Connection Modules for sensors and actuators	8 x 3-conductor sensors	LED indicator for positive switching	289-664	184	
		LED indicator for negative switching	289-665	184	
			289-666	184	
	8 actuators		289-667	184	
		with ground (earth) contact		289-671	184

Overview: Transducers



857 Series

JUMPFLEX® – Transducers

Function	Input Signal (switchable in a calibrated way)	Output Signal (switchable in a calibrated way)	Configuration	Electrical Isolation	Supply Voltage V_N	Item No.	Page
Isolation Amplifier	0 ... 20 mA, 4 ... 20 mA, 0 ... 5 V, 0 ... 10 V, 2 ... 10 V, 1 ... 5 V	0 ... 20 mA, 4 ... 20 mA, 0 ... 5 V, 0 ... 10 V, 2 ... 10 V, 1 ... 5 V	DIP switch	3 ways, 2.5 kV	24 V DC	857-400	194
Isolation Amplifier, Configurable with Digital Output	-10...+10 V, -20...+20 mA, 0...+30 V (31,2 V (V_{IN}) 100 mA (I_{IN}))	0 ... 20 mA, 4 ... 20 mA, 0 ... 10 V, 2 ... 10 V, 0... 5 V, 1 ... 5 V, 0 ... 10 mA, 2 ... 10 mA	DIP switch or configuration software	3 ways, 2.5 kV	24 V DC	857-401	196
Bipolar Isolation Amplifier	± 5 V, 0 ... 5 V, 1 ... 5 V, ± 10 V, 0 ... 10 V, 2 ... 10 V, ± 10 mA, 0 ... 10 mA, 2 ... 10 mA, ± 20 mA, 0 ... 20 mA, 4 ... 20 mA	± 5 V, 0 ... 5 V, 1 ... 5 V, ± 10 V, 0 ... 10 V, 2 ... 10 V, ± 10 mA, 0 ... 10 mA, 2 ... 10 mA, ± 20 mA, 0 ... 20 mA, 4 ... 20 mA	DIP switch	3 ways, 2.5 kV	24 V DC	857-409	198
Isolation Amplifier Fixed (Current)	0(4) ... 20 mA	0(4) ... 20 mA	–	3 ways, 2.5 kV	24 V DC	857-411	200
Isolation Amplifier Fixed (Voltage)	0(2) ... 10 V	0(2) ... 10 V	–	3 ways, 2.5 kV	24 V DC	857-412	200
Passive Isolator 1-Channel	0(4) ... 20 mA	0(4) ... 20 mA	–	2 ways, 2.5 kV	24 V DC	857-451	201
Passive Isolator 2-Channel	0(4) ... 20 mA	0(4) ... 20 mA	–	2 ways, 2.5 kV	24 V DC	857-452	201
Repeater Power Supply	0 ... 20 mA, 4 ... 20 mA	0 ... 20 mA, 4 ... 20 mA, 0 ... 5 V, 0 ... 10 V, 2 ... 10 V, 1 ... 5 V	DIP switch	3 ways, 2.5 kV	24 V DC	857-420	202
Repeater Power Supply HART	4 ... 20 mA	4 ... 20 mA	–	3 ways, 2.5 kV	24 V DC	857-421	204
Signal Splitter	0 ... 20 mA, 4 ... 20 mA, 0 ... 5 V, 0 ... 10 V, 2 ... 10 V, 1 ... 5 V	2 x 0(4) ... 20 mA	DIP switch	4 ways, 2.5 kV	24 V DC	857-423	206
Millivolt Transducer	-100 mV ... +100 mV, 0 mV ... 200 mV bis 0 mV ... 1000 mV (in steps of 100)	0 ... 20 mA, 4 ... 20 mA, 0 ... 10 V, 2 ... 10 V, 0... 5 V, 1 ... 5 V, 0 ... 10 mA, 2 ... 10 mA	DIP switch or configuration software	3 ways, 2.5 kV	24 V DC	857-819	216
Threshold Value Switch	-10...+10 V, -20...+20 mA, 0...+30 V (31,2 V (V_{IN}) 100 mA (I_{IN}))	1 changeover contact (relay max. 6A) 1 digital switching output	DIP switch, teach-in, configuration software	4 ways, 2.5 kV	24 V DC	857-531	218



786 Series

Signal Conditioning Modules

Function	Input	Output	Electrical Isolation	Supply Voltage V_N	Item No.	Page
Signal Conditioning Modules for Standard Signals	0 ... 10 V	0 ... 10 V	2 ways, 4 kV	24 V DC	786-301	230
			3 ways, 4 kV		786-321	230
		0 ... 20 mA	2 ways, 4 kV		786-302	230
			3 ways, 4 kV		786-322	230
		4 ... 20 mA	2 ways, 4 kV		786-303	230
			3 ways, 4 kV		786-323	230
	0 ... 20 mA	0 ... 10 V	2 ways, 4 kV	24 V DC	786-304	231
			3 ways, 4 kV		786-324	232
		0 ... 20 mA	2 ways, 4 kV		786-305	231
			3 ways, 4 kV		786-325	232
		4 ... 20 mA	2 ways, 4 kV		786-306	231
			3 ways, 4 kV		786-326	232
	4 ... 20 mA	0 ... 10 V	2 ways, 4 kV	24 V DC	786-307	231
			3 ways, 4 kV		786-337	232
		0 ... 20 mA	2 ways, 4 kV		786-308	231
3 ways, 4 kV			786-338		232	
4 ... 20 mA		2 ways, 4 kV	786-309		231	
		3 ways, 4 kV	786-339		232	

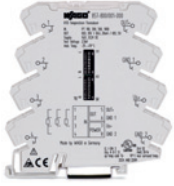

857 Series

JUMPFLEX® – Temperature Transducers for RTD and Thermocouples

Function	Input Signal	Connection	Output Signal	Configuration	Electrical Isolation	Supply Voltage V_N	Item No.	Page
Temperature Transducers for RTD	Pt 100, Pt 200, Pt 500, Pt 1000 0 ... 1 k Ω , 0 ... 4.5 k Ω	2 wire, 3 wire, 4 wire	0 ... 20 mA, 4 ... 20 mA, 0 ... 10 V, 2 ... 10 V, 0 ... 5 V, 1 ... 5 V, 0 ... 10 mA, 2 ... 10 mA	Dip switch	3 ways, 2.5 kV	24 V DC	857-800	208
Temperature Transducers for RTD	Pt 100, Pt 200, Pt 500, Pt 1000 0 ... 1 k Ω , 0 ... 4.5 k Ω	2 wire, 3 wire, 4 wire	0 ... 20 mA, 4 ... 20 mA, 0 ... 10 V, 2 ... 10 V, 0 ... 5 V, 1 ... 5 V, 0 ... 10 mA, 2 ... 10 mA	Dip switch or configuration Software	3 ways, 2.5 kV	24 V DC	857-801	210
Temperature Transducers for Thermocouples	Thermocouples of types J and K		0 ... 20 mA, 4 ... 20 mA, 0 ... 10 V, 2 ... 10 V, 0 ... 5 V, 1 ... 5 V, 0 ... 10 mA, 2 ... 10 mA	Dip switch	3 ways, 2.5 kV	24 V DC	857-810	212
Temperature Transducers for Thermocouples	Thermocouples of types J and K		0 ... 20 mA, 4 ... 20 mA, 0 ... 10 V, 2 ... 10 V, 0 ... 5 V, 1 ... 5 V, 0 ... 10 mA, 2 ... 10 mA	Dip switch or configuration Software	3 ways, 2.5 kV	24 V DC	857-811	214



286 Series

Temperature Transducers

Function	Input	Temperature Range	Connection	Output	Electrical Isolation	Supply Voltage V_N	Item No.	Page
Temperature Transducers	Pt 100	0 °C ... 100 °C	2 wire	0 ... 10 V	–	24 V DC	286-860	224
			3 wire				286-870	224
			2 wire	0 ... 20 mA			286-861	224
			3 wire				286-871	224
			2 wire	4 ... 20 mA			286-862	224
			3 wire				286-872	224
		-30 °C ... +150 °C	2 wire	0 ... 10 V	–	24 V DC	286-860/150-030	226
			3 wire				286-870/150-030	226
			2 wire	0 ... 20 mA			286-861/150-030	226
			3 wire				286-871/150-030	226
			2 wire	4 ... 20 mA			286-862/150-030	226
			3 wire				286-872/150-030	226
	0 °C ... 300 °C	2 wire	0 ... 10 V	–	24 V DC	286-860/000-300	227	
		3 wire				286-870/000-300	227	
		2 wire	0 ... 20 mA			286-861/000-300	227	
		3 wire				286-871/000-300	227	
		2 wire	4 ... 20 mA			286-862/000-300	227	
		3 wire				286-872/000-300	227	
	Pt 1000	0 °C ... 100 °C	2 wire	–	24 V DC	286-873	228	
						0 ... 20 mA	286-874	228
						4 ... 20 mA	286-875	228
	Thermocouple Typ J	0 °C ... 750 °C		–	24 V DC	286-863	225	
						0 ... 20 mA	286-865	225
						4 ... 20 mA	286-867	225
Thermocouple Typ K	0 °C ... 1000 °C		–	24 V DC	286-864	225		
					0 ... 10 V	286-866	225	
					0 ... 20 mA	286-868	225	

859 Series

Relay Modules and
Optocoupler Modules

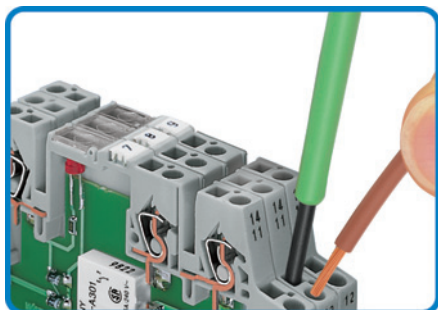

Connection of conductor

857 Series

JUMPFLEX® - Transducers / Relay and
Optocoupler Modules

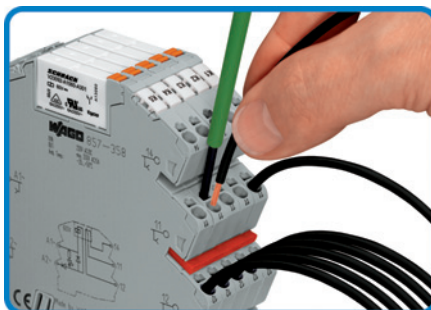

Connection of conductor



Operation of the relay ejector

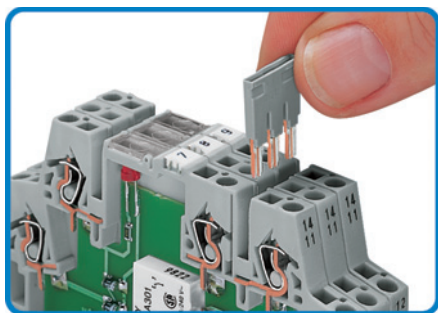

Easy commoning using
adjacent jumpers

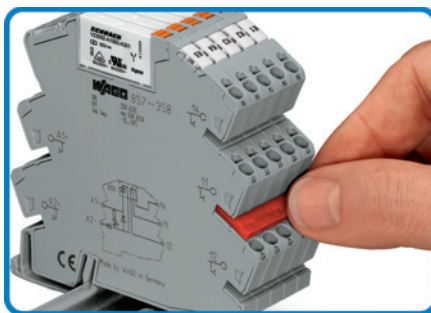

Easy commoning using
adjacent jumpers



Configuration of the Transducers with
WAGO-USB-Service-Cable 750-923

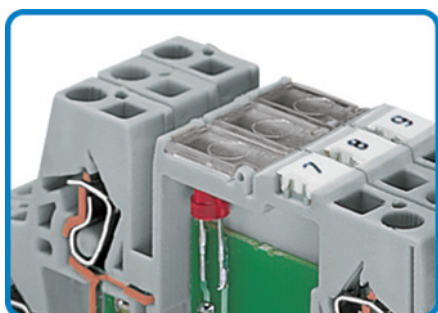

Marking using Miniature quick
marking card



Marking using WMB Multi markers

788 Series
Sockets for Miniature Switching Relay /
Optocoupler

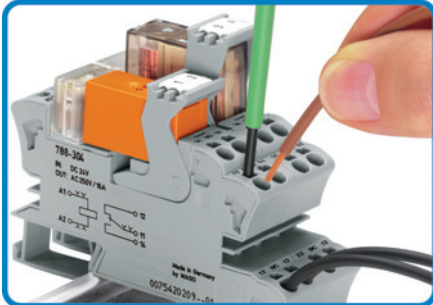

Connection of conductor

858 Series
Sockets with Industrial Relay

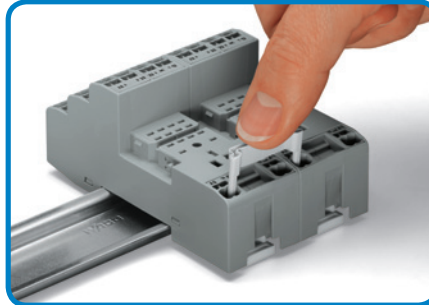

Easy commoning using
adjacent jumpers

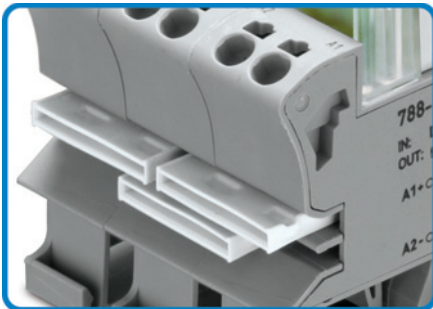

Easy commoning using
adjacent jumpers

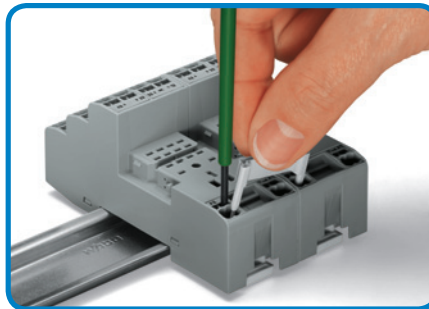

Remove jumper with screwdriver

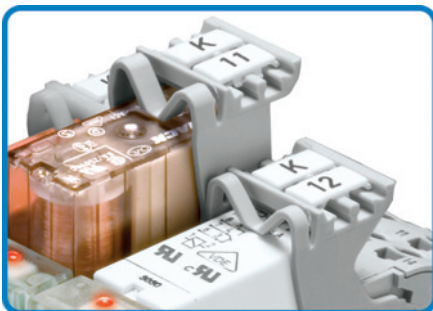

Marking using WMB Multi markers
and group marker carriers

287 / 288 Series Mounting Carriers with Miniature Switching Relay

286 / 786 Series Pluggable Function Modules

789 Series Relay Modules in DIN-Rail Mounted Enclosure

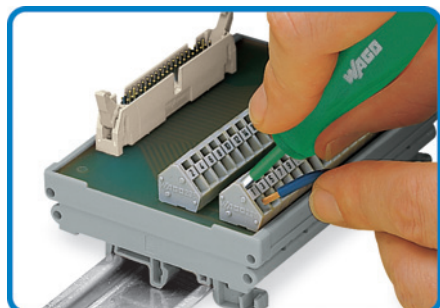

Connection of conductor "front-entry"

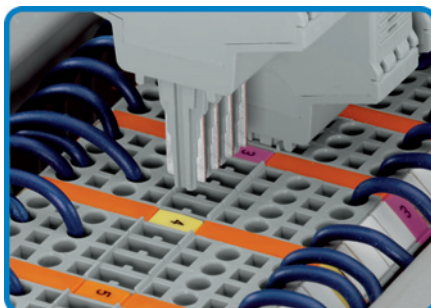

Coding ensures correct polarity

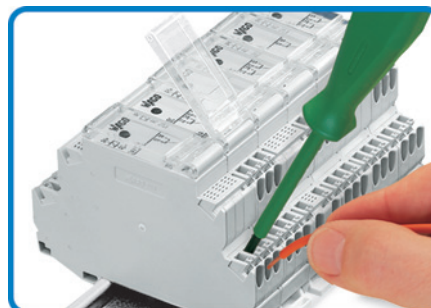

Connection of conductor

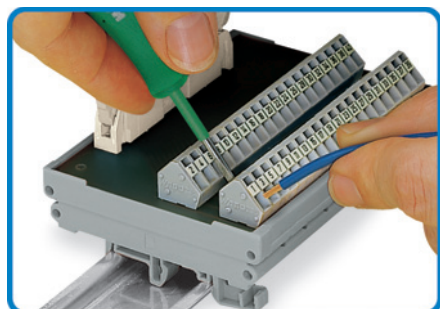

Connection of conductor "side-entry"

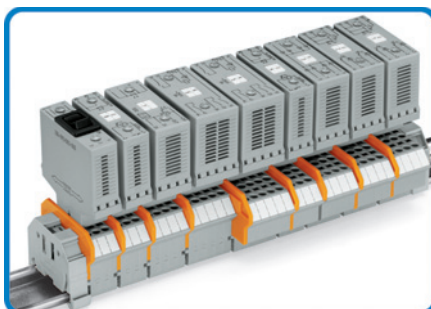

Pluggable electronic modules, for application on 2- or 4-conductor carrier terminal blocks

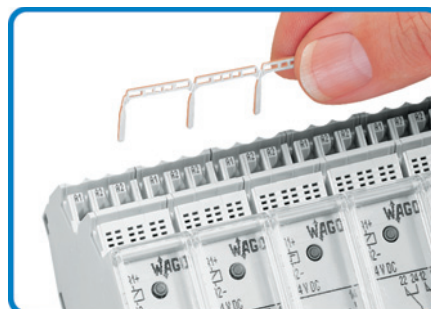

Easy commoning using adjacent jumpers

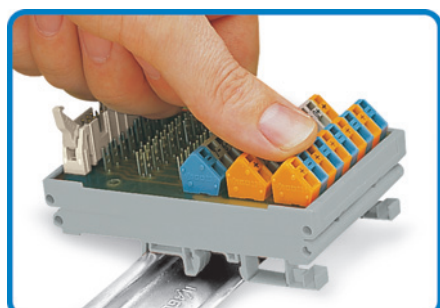

Assembly of a module on the carrier rail



Marking using WMB Multi markers

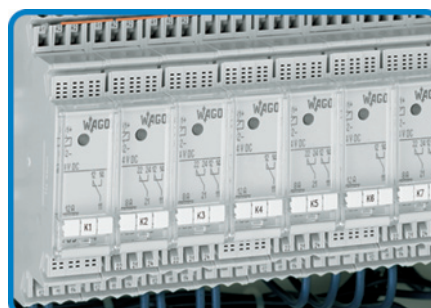

Marking using Miniature quick marking card

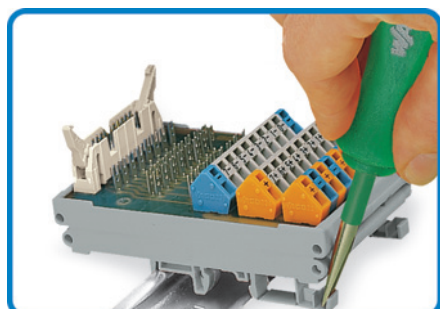

Removal of a module from the carrier rail



Easy testing at touchproof contacts

289 Series Interface Modules

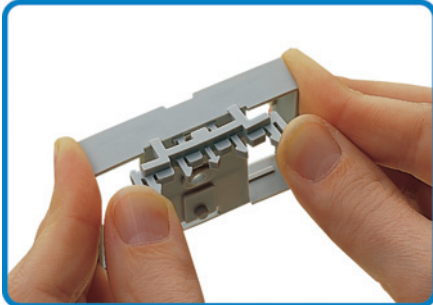

Mounting carrier, gray, snap-fit mounting of universal mounting feet

289 Series Interface Modules

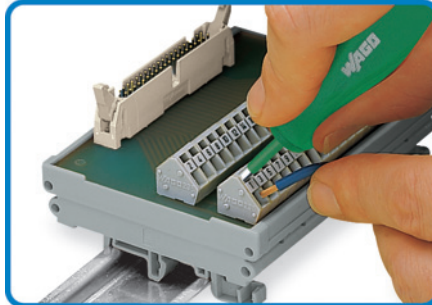

Connection of conductor "front-entry"

289 Series Interface Modules

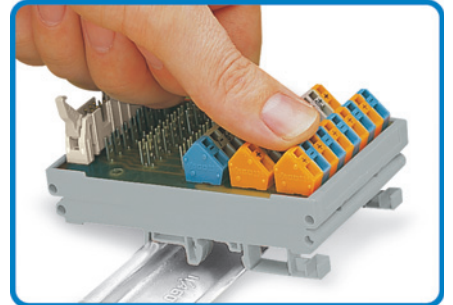

Assembly of a module on the carrier rail

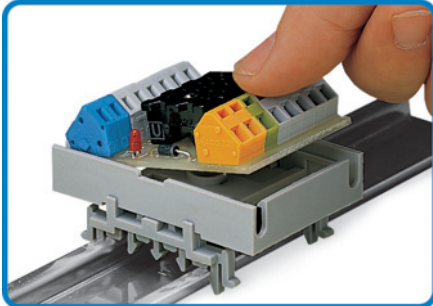

Fitting of an individual module to the mounting carrier

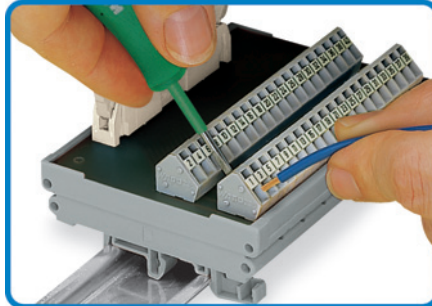

Connection of conductor "side-entry"

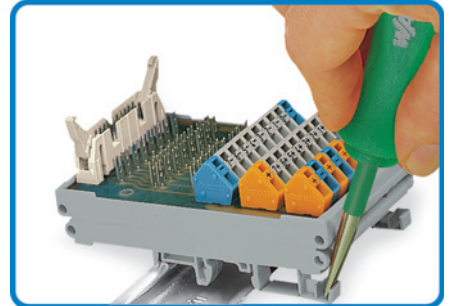

Removal of a module from the carrier rail

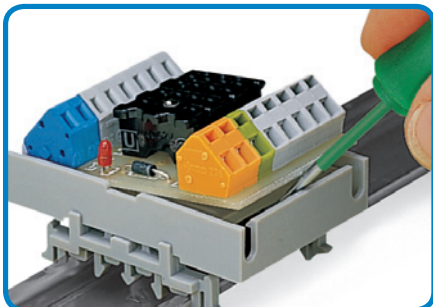

Removal of an individual module from the mounting carrier



**WAGO Application: Cerestar (Cargill GmbH),
Barby, Saxony-Anhalt, Germany**

Manufacturer of starches and starch derivatives.

WAGO Products:

Matrix Patchboards and Pluggable Electronic
Modules



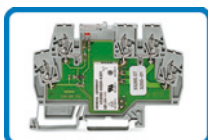

859 Series

Rail-Mounted Terminal Blocks with Miniature Switching Relay	32 – 38
Rail-Mounted Terminal Blocks with Optocoupler	39 – 47
Rail-Mounted Terminal Blocks with Miniature Switching Relays and Optocouplers with an Extended Input Voltage and Operating Temperature Range	48
Accessories, 859 Series	49



857 Series

JUMPFLEX® Relay Socket with Miniature Switching Relay	50 – 51
Miniature Switching Relays, Sockets, JUMPFLEX® 8-Channel Adapters for System Wiring	52 – 55
JUMPFLEX® Relay Socket with Solid State Relay	56 – 61
Solid State Relays	62
Accessories, 857 Series	63

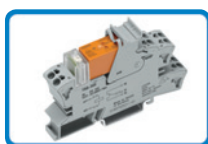

788 Series

Sockets with Miniature Switching Relay	64 – 73
Miniature Switching Relays, Sockets	74 – 77
Sockets with Solid State Relay	78 – 79
Accessories, 788 Series	80 – 81



858 Series

Sockets with Industrial Relay	82 – 83
Industrial Relays, Sockets	84 – 85
Accessories, 858 Series	86

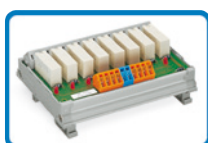

287/288 Series

Mounting Carriers with Miniature Switching Relay	88 – 99
--	---------



286 Series

Pluggable Modules – Relays, Time Relays, Optocouplers, SO Optocouplers, SO Supply Module, NAMUR Switching Amplifiers, Current Flow Monitoring, Switches, Bridge Rectifiers, Fuses, Diode Gates, AND Gate and LED Indicator, Flip-Flop, Fault Indication, Surge Suppression Devices	100 – 139
--	-----------



789 Series

Relay Modules in DIN-Rail Mounted Enclosure	140 – 145
Accessories, Series 789	146
4-Channel EnOcean Radio Receiver in DIN-Rail-Mountable Enclosure	148
Manual Control Modules	149

	Relay with 1 changeover contact (1u) for normal switching power Nominal input voltage V_N 5 V, 12 V, 24 V, 48 V, 60 V, 110 V, 220 V DC	Relay with 1 changeover contact (1u) for normal switching power Nominal input voltage V_N 12 V, 24 V, 48 V, 115 V, 230 V AC/DC
--	--	--

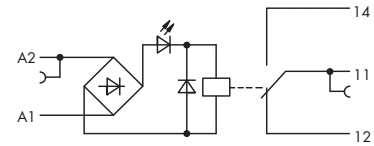
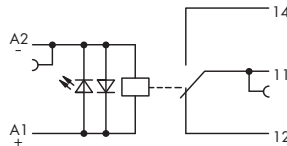
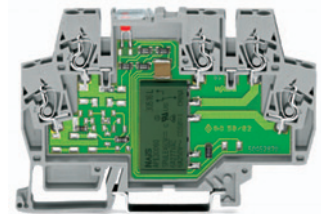
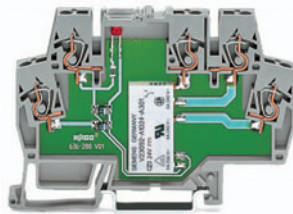
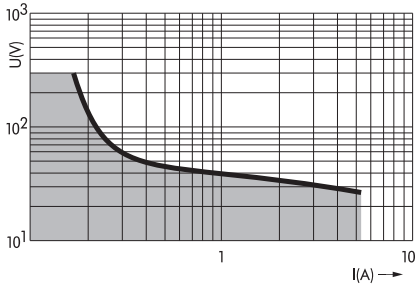

Note: Inductive loads have to be attenuated by an appropriate protective circuit in order to protect relay coils and contacts.

Description	V_N	I_N	Item No.	Pack. Unit	V_N	I_N	Item No.	Pack. Unit
Rail-mounted terminal blocks with miniature switching relay, for DIN 35 rail	5 V DC	31 mA	859-302	1	12 V AC/DC	15 mA	859-353	1
	12 V DC	17 mA	859-303	1	24 V AC/DC	8 mA	859-354	1
	24 V DC	10 mA	859-304	1	48 V AC/DC	5.3 mA	859-355	1
	48 V DC	6.5 mA	859-305	1	115 V AC/DC	3.5 mA	859-357	1
	60 V DC	5.2 mA	859-306	1	230 V AC/DC	3.5 mA	859-358	1
	120 V DC	3.5 mA	859-307	1				
	220 V DC	3.2 mA	859-308	1				

Technical Data	Accessories see page 49	
Contact material	AgSnO ₂	AgSnO ₂
Input voltage range	V_N -15 % ... +10 %	V_N -15 % ... +10 %
Max. switching voltage	250 V AC	250 V AC
Max. continuous current (terminal blocks in a row)	5 A	5 A
Max. Switching power (resistive)	1250 VA AC ; DC see load limit curve	1250 VA AC ; DC see load limit curve
Recommended minimum load	≥ 100 mA / 12 V AC/DC	≥ 100 mA / 12 V AC/DC
Max. switching rate with / without load	6 min ⁻¹ / 20 s ⁻¹	6 min ⁻¹ / 20 s ⁻¹
Operating power	< 320 mW	< 300 mW
Pull-in/drop-out/bounce time typ.	5 ms / 6 ms / 5 ms	5 ms / 6 ms / 5 ms
Nominal operating mode	continuous duty	continuous duty
Dielectric strength contact-coil	4 kV	4 kV
Dielectric strength contact-coil (1.2/50 μ s)	6 kV	6 kV
Surge capacity open contact	1 kV	1 kV
Nominal voltage acc. to VDE 0110 Part 1/4.97, IEC 60664-1	250 V / 4 kV / 3	250 V / 4 kV / 3
Mechanical life	5 x 10 ⁶ switching operations	5 x 10 ⁶ switching operations
Mechanical life at max. load (resistance)	3 x 10 ⁵ switching operations	3 x 10 ⁴ switching operations
Ambient operating temperature (V_N)	-25 °C ... +50 °C	-25 °C ... +50 °C
Ambient operating temperature (1.2 x V_N)	-25 °C ... +40 °C	-25 °C ... +40 °C
Storage temperature	-40 °C ... +70 °C	-40 °C ... +70 °C
Dimensions (mm) W x H x L	6 x 56 x 91	6 x 56 x 91
Wire connection	Height from upper-edge of DIN 35 rail CAGE CLAMP®	Height from upper-edge of DIN 35 rail CAGE CLAMP®
Cross sections	0.08 mm ² ... 2.5 mm ² / AWG 28 ... 14	0.08 mm ² ... 2.5 mm ² / AWG 28 ... 14
Stripped lengths	5 ... 6 mm / 0.22 in	5 ... 6 mm / 0.22 in
Approvals	VDE 0110 / EN 60664; VDE 0435 / EN 61810-5; UL 508; EEx nC II T4 / DEMKO 02 ATEX 132280U; Ⓢ	VDE 0110 / EN 60664; VDE 0435 / EN 61810-5; UL 508; EEx nC II T4 / DEMKO 02 ATEX 132280U; Ⓢ

	<p>Relay with 1 changeover contact (1u) Contacts 5 µm Au hard gold plated for normal switching power Nominal input voltage V_N 24 V DC</p>	<p>Relay with 1 changeover contact (1u) Contacts 5 µm Au hard gold plated with an extended Input voltage range: V_N -30 % ... +25 % Operating temperature range: -25 °C ... +70 °C for normal switching power Nominal input voltage V_N 115 V DC</p>
--	---	---

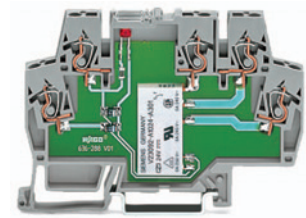
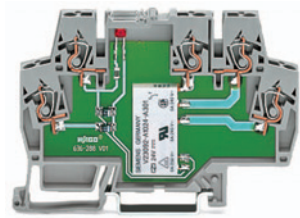
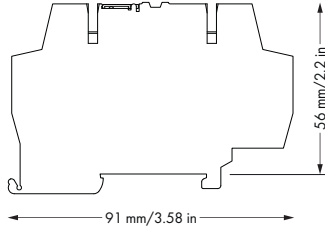

* In order to prevent the gold layer from being damaged these values should not be exceeded. Higher switching power leads to evaporation of the gold layer. The resulting deposits in the enclosure may cause sparkovers between the coil and the contact.

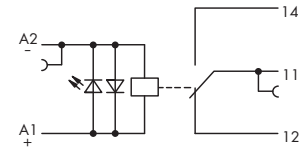
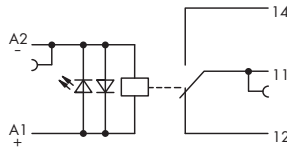

Description	V _N	I _N	Item No.	Pack. Unit	V _N	I _N	Item No.	Pack. Unit
Rail-mounted terminal blocks with miniature switching relay, for DIN 35 rail	24 V DC	10 mA	859-314	1	115 V DC	3.1 mA	859-317	1

Technical Data

Accessories see page 49

Accessories see page 49

Contact material	AgSnO ₂ + 5 µm Au	AgSnO ₂ + 5 µm Au
Input voltage range	V _N -15 % ... +20 %	V _N -30 % ... +25 %
Max. switching voltage	36 V DC *	36 V DC *
Max. continuous current (terminal blocks in a row)	50 mA *	50 mA *
Recommended minimum load	10 µA / 100 mV	10 µA / 100 mV
Max. switching rate with / without load	6 min ⁻¹ / 20 s ⁻¹	6 min ⁻¹ / 20 s ⁻¹
Operating power	< 320 mW	< 320 mW
Pull-in/drop-out/bounce time typ.	5 ms / 6 ms / 5 ms	5 ms / 6 ms / 5 ms
Nominal operating mode	continuous duty	continuous duty
Dielectric strength contact-coil	4 kV	4 kV
Dielectric strength contact-coil (1.2/50 µs)	6 kV	6 kV
Surge capacity open contact	1 kV	1 kV
Nominal voltage acc. to VDE 0110 Part 1/4.97, IEC 60664-1	250 V / 4 kV / 3	250 V / 4 kV / 3
Mechanical life	5 x 10 ⁶ switching operations	5 x 10 ⁶ switching operations
Mechanical life at max. load (resistance)	5 x 10 ⁶ switching operations	5 x 10 ⁶ switching operations
Ambient operating temperature (V _N)	-25 °C ... +50 °C	-25 °C ... +70 °C
Ambient operating temperature (1.2 x V _N)	-25 °C ... +40 °C	-25 °C ... +70 °C
Storage temperature	-40 °C ... +70 °C	-40 °C ... +70 °C
Dimensions (mm) W x H x L	6 x 56 x 91	6 x 56 x 91
Wire connection	Height from upper-edge of DIN 35 rail CAGE CLAMP®	Height from upper-edge of DIN 35 rail CAGE CLAMP®
Cross sections	0.08 mm ² ... 2.5 mm ² / AWG 28 ... 14	0.08 mm ² ... 2.5 mm ² / AWG 28 ... 14
Stripped lengths	5 ... 6 mm / 0.22 in	5 ... 6 mm / 0.22 in
Approvals	VDE 0110 / EN 60664; VDE 0435 / EN 61810-5; UL 508; EEx nC II T4 / DEMKO 02 ATEX 132280U; Ⓢ	VDE 0110 / EN 60664; VDE 0435 / EN 61810-5; UL 508; EEx nC II T4 / DEMKO 02 ATEX 132280U; Ⓢ

Relay with 1 changeover contact (1u)
Contacts 5 μm Au hard gold plated
for normal switching power
Nominal input voltage V_N 230 V AC

Relay with 1 changeover contact (1u)
Contacts 5 μm Au hard gold plated
for normal switching power
Nominal input voltage V_N 115 V AC

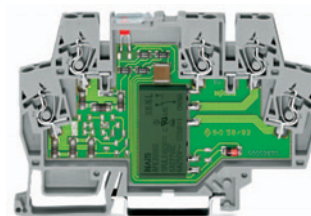
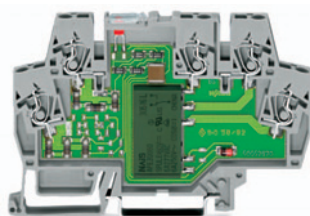
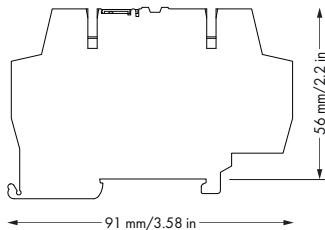

* In order to prevent the gold layer from being damaged these values should not be exceeded. Higher switching power leads to evaporation of the gold layer. The resulting deposits in the enclosure may cause sparkovers between the coil and the contact.

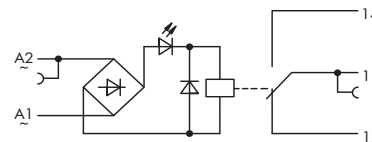
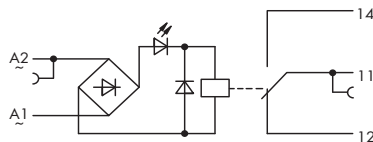

Description	V_N	I_N	Item No.	Pack. Unit	V_N	I_N	Item No.	Pack. Unit
Rail-mounted terminal blocks with miniature switching relay, for DIN 35 rail	230 V AC	3.5 mA	859-359	1	115 V AC	3.1 mA	859-360	1

Technical Data	Accessories see page 49	
Contact material	AgSnO ₂ + 5 μm Au	AgSnO ₂ + 5 μm Au
Input voltage range	V_N -15 % ... +10 %	V_N -15 % ... +20 %
Max. switching voltage	36 V DC *	36 V DC *
Max. continuous current (terminal blocks in a row)	50 mA *	50 mA *
Recommended minimum load	10 μA / 100 mV	10 μA / 100 mV
Max. switching rate with / without load	6 min ⁻¹ / 20 s ⁻¹	6 min ⁻¹ / 20 s ⁻¹
Operating power	< 820 mW	< 370 mW
Pull-in/drop-out/bounce time typ.	5 ms / 6 ms / 5 ms	5 ms / 6 ms / 5 ms
Nominal operating mode	continuous duty	continuous duty
Dielectric strength contact-coil	4 kV	4 kV
Dielectric strength contact-coil (1.2/50 μs)	6 kV	6 kV
Surge capacity open contact	1 kV	1 kV
Nominal voltage acc. to VDE 0110 Part 1/4.97, IEC 60664-1	250 V / 4 kV / 3	250 V / 4 kV / 3
Mechanical life	5 x 10 ⁶ switching operations	5 x 10 ⁶ switching operations
Mechanical life at max. load (resistance)	5 x 10 ⁶ switching operations	5 x 10 ⁶ switching operations
Ambient operating temperature (V_N)	-25 °C ... +50 °C	-25 °C ... +50 °C
Ambient operating temperature (1.2 x V_N)	-25 °C ... +40 °C	-25 °C ... +40 °C
Storage temperature	-40 °C ... +70 °C	-40 °C ... +70 °C
Dimensions (mm) W x H x L	6 x 56 x 91	6 x 56 x 91
Wire connection	Height from upper-edge of DIN 35 rail CAGE CLAMP®	Height from upper-edge of DIN 35 rail CAGE CLAMP®
Cross sections	0.08 mm ² ... 2.5 mm ² / AWG 28 ... 14	0.08 mm ² ... 2.5 mm ² / AWG 28 ... 14
Stripped lengths	5 ... 6 mm / 0.22 in	5 ... 6 mm / 0.22 in
Approvals	VDE 0110 / EN 60664; VDE 0435 / EN 61810-5; UL 508; EEx nC II T4 / DEMKO 02 ATEX 132280U; Ⓢ	VDE 0110 / EN 60664; VDE 0435 / EN 61810-5; UL 508; EEx nC II T4 / DEMKO 02 ATEX 132280U; Ⓢ

	<p>Relay with 1 changeover contact (1u) Contacts 5 µm Au hard gold plated for low switching power Nominal input voltage V_N 220 V DC</p>	<p>Relay with 1 changeover contact (1u) for normal switching power Nominal input voltage V_N 115 V AC</p>
--	---	--

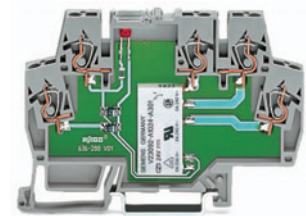
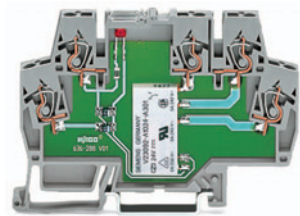
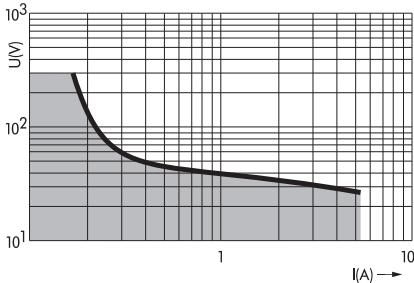

* In order to prevent the gold layer from being damaged these values should not be exceeded. Higher switching power leads to evaporation of the gold layer. The resulting deposits in the enclosure may cause sparkover between the coil and the contact.

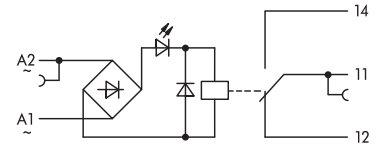
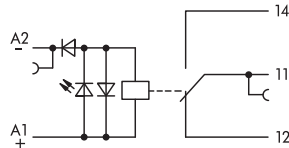

Description	V _N	I _N	Item No.	Pack. Unit	V _N	I _N	Item No.	Pack. Unit
Rail-mounted terminal blocks with miniature switching relay, for DIN 35 rail	220 V DC	3.2 mA	859-318	1	115 V AC	4.2 mA	859-367	1

Technical Data

Accessories see page 49

Accessories see page 49

Contact material	AgSnO ₂ + 5 µm Au	AgSnO ₂
Input voltage range	V _N -15 % ... +20 %	V _N ± 10 %
Turn-on threshold relay/LED		95 V AC/ 80 V AC
Turn-off threshold relay/LED		60 V AC/60 V AC
Max. switching voltage	36 V DC *	250 V AC
Max. continuous current (terminal blocks in a row)	50 mA *	5 A
Max. Switching power (resistive)		1250 VA AC ; DC see load limit curve
Recommended minimum load	50 mW	≥ 100 mA / 12 V AC/DC
Max. switching rate with / without load	6 min ⁻¹ / 20 s ⁻¹	6 min ⁻¹ / 20 s ⁻¹
Operating power	< 750 mW	< 820 mW
Pull-in/drop-out/bounce time typ.	5 ms / 6 ms / 5 ms	5 ms / 6 ms / 5 ms
Nominal operating mode	continuous duty	continuous duty
Dielectric strength contact-coil	4 kV	4 kV
Dielectric strength contact-coil (1.2/50 µs)	6 kV	6 kV
Surge capacity open contact	1 kV	1 kV
Nominal voltage acc. to VDE 0110 Part 1/4.97, IEC 60664-1	250 V / 4 kV / 3	250 V / 4 kV / 3
Mechanical life	5 x 10 ⁶ switching operations	5 x 10 ⁶ switching operations
Mechanical life at max. load (resistance)	5 x 10 ⁶ switching operations	3 x 10 ⁴ switching operation
Ambient operating temperature (V _N)	-25 °C ... +50 °C	-25 °C ... +50 °C
Storage temperature	-40 °C ... +70 °C	-40 °C ... +70 °C
Dimensions (mm) W x H x L	6 x 56 x 91	6 x 56 x 91
	Height from upper-edge of DIN 35 rail	Height from upper-edge of DIN 35 rail
Wire connection	CAGE CLAMP®	CAGE CLAMP®
Cross sections	0.08 mm ² ... 2.5 mm ² / AWG 28 ... 14	0.08 mm ² ... 2.5 mm ² / AWG 28 ... 14
Stripped lengths	5 ... 6 mm / 0.22 in	5 ... 6 mm / 0.22 in
Approvals	VDE 0435 (corresp. parts); DIN EN 61810; DIN VDE 0140, DIN EN 61140 E175199, UL 508; Ⓢ	DIN VDE 0160, DIN EN 50178; VDE 0435 (corresp. parts); DIN EN 61810; VDE 0140, DIN EN 61140; Ⓢ

Relay with 1 changeover contact (1u) defined turn-on/turn-off threshold for normal switching power
Nominal input voltage V_N 230 V AC

Relay with 1 changeover contact (1u) with an extended
Input voltage range: V_N -30 % ... +25 %
Operating temperature range: -25 °C ... +70 °C for normal switching power
Nominal input voltage V_N 24 V DC

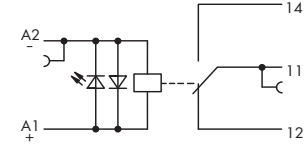
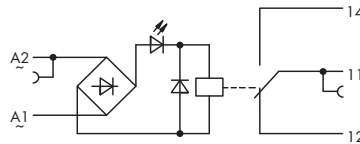
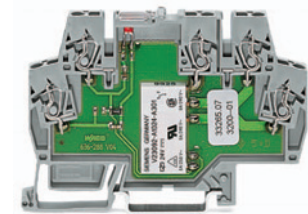
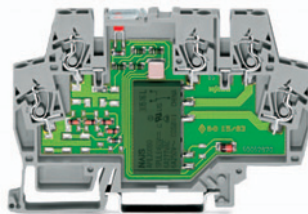
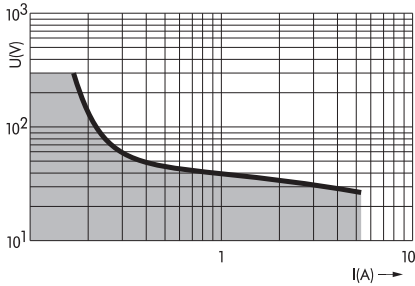

Note: Inductive loads have to be attenuated by an appropriate protective circuit in order to protect relay coils and contacts.

Description	V_N	I_N	Item No.	Pack. Unit	V_N	I_N	Item No.	Pack. Unit
Rail-mounted terminal blocks with miniature switching relay, for DIN 35 rail	230 V AC	4.2 mA	859-368	1	24 V DC	12 mA	859-390	1

Technical Data	Accessories see page 49	
Contact material	AgSnO ₂	AgSnO ₂
Input voltage range	$V_N \pm 10\%$	$V_N -30\% \dots +25\%$
Turn-on threshold relay/LED	190 V AC / 165 V AC	
Turn-off threshold relay/LED	140 V AC / 150 V AC	
Max. switching voltage	250 V AC	250 V AC
Max. continuous current (terminal blocks in a row)	5 A	3 A
Max. Switching power (resistive)	1250 VA AC ; DC see load limit curve	750 VA AC ; DC see load limit curve
Recommended minimum load	≥ 100 mA / 12 V AC/DC	≥ 100 mA / 15 V AC/DC
Max. switching rate with / without load	6 min ⁻¹ / 20 s ⁻¹	6 min ⁻¹ / 20 s ⁻¹
Operating power	< 820 mW	< 320 mW
Pull-in/drop-out/bounce time typ.	5 ms / 6 ms / 5 ms	5 ms / 6 ms / 5 ms
Nominal operating mode	continuous duty	continuous duty
Dielectric strength contact-coil	4 kV	4 kV
Dielectric strength contact-coil (1.2/50 μ s)	6 kV	6 kV
Surge capacity open contact	1 kV	1 kV
Nominal voltage acc. to VDE 0110 Part 1/4.97, IEC 60664-1	250 V / 4 kV / 3	250 V / 4 kV / 3
Mechanical life	5 x 10 ⁶ switching operations	5 x 10 ⁶ switching operations
Mechanical life at max. load (resistance)	3 x 10 ⁴ switching operation	3 x 10 ⁵ switching operation
Ambient operating temperature (V_N)	-25 °C ... +50 °C	-25 °C ... +70 °C
Storage temperature	-40 °C ... +70 °C	-40 °C ... +70 °C
Dimensions (mm) W x H x L	6 x 56 x 91	6 x 56 x 91
Wire connection	Height from upper-edge of DIN 35 rail CAGE CLAMP®	Height from upper-edge of DIN 35 rail CAGE CLAMP®
Cross sections	0.08 mm ² ... 2.5 mm ² / AWG 28 ... 14	0.08 mm ² ... 2.5 mm ² / AWG 28 ... 14
Stripped lengths	5 ... 6 mm / 0.22 in	5 ... 6 mm / 0.22 in
Approvals	VDE 0110 / EN 60664; VDE 0435 / EN 61810-5; UL 508; EEx nC II T4 / DEMKO 02 ATEX 132280U; Ⓢ	VDE 0110 / EN 60664; VDE 0435 / EN 61810-5; UL 508; EEx nC II T4 / DEMKO 02 ATEX 132280U; Ⓢ

	<p>Relay with 1 changeover contact (1u) with an extended Input voltage range: $V_N \pm 30\%$ Operating temperature range: $-25\text{ °C} \dots +70\text{ °C}$ for normal switching power Nominal input voltage V_N 110 V DC</p>	<p>Relay with 1 changeover contact (1u) with an extended Input voltage range: $V_N \pm 40\%$ Operating temperature range: $-25\text{ °C} \dots +70\text{ °C}$ for normal switching power Nominal input voltage V_N 24 V DC</p>
--	--	---

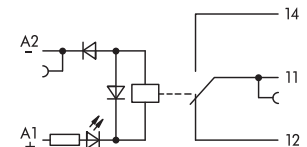
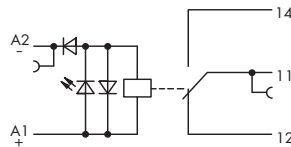
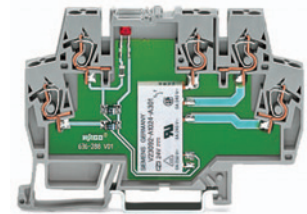
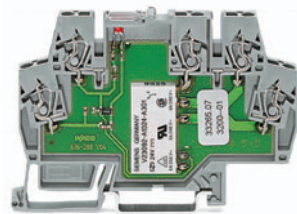
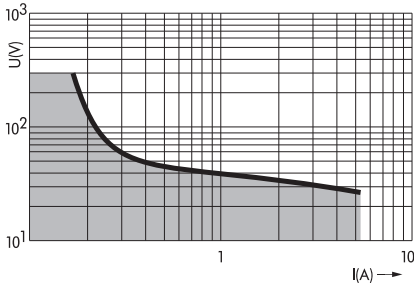

NOTE: Inductive loads have to be attenuated by an appropriate protective circuit in order to protect relay coils and contacts.

Description	V_N	I_N	Item No.	Pack. Unit	V_N	I_N	Item No.	Pack. Unit
Rail-mounted terminal blocks with miniature switching relay, for DIN 35 rail	110 V DC	2.7 mA	859-391	1	24 V DC	14.4 mA	859-398	1

Technical Data	Accessories see page 49	
Contact material	AgSnO ₂	AgSnO ₂
Input voltage range	$V_N \pm 30\%$	$V_N \pm 40\%$
Max. switching voltage	250 V AC	250 V AC
Max. continuous current (terminal blocks in a row)	3 A	3 A
Max. Switching power (resistive)	750 VA AC ; DC see load limit curve	750 VA AC ; DC see load limit curve
Recommended minimum load	$\geq 100\text{ mA} / 15\text{ V AC/DC}$	$\geq 100\text{ mA} / 12\text{ V AC/DC}$
Max. switching rate with / without load	$6\text{ min}^{-1} / 20\text{ s}^{-1}$	$6\text{ min}^{-1} / 20\text{ s}^{-1}$
Operating power	$< 370\text{ mW}$	$< 400\text{ mW}$
Pull-in/drop-out/bounce time typ.	5 ms / 6 ms / 5 ms	5 ms / 6 ms / 5 ms
Nominal operating mode	continuous duty	continuous duty
Dielectric strength contact-coil	4 kV	4 kV
Dielectric strength contact-coil (1.2/50 μs)	6 kV	6 kV
Surge capacity open contact	1 kV	1 kV
Nominal voltage acc. to VDE 0110 Part 1/4.97, IEC 60664-1	250 V / 4 kV / 3	250 V / 4 kV / 3
Mechanical life	5×10^6 switching operations	1×10^7 switching operations
Mechanical life at max. load (resistance)	3×10^4 switching operation	3×10^4 switching operation
Ambient operating temperature (V_N)	$-25\text{ °C} \dots +70\text{ °C}$	$-25\text{ °C} \dots +70\text{ °C}$
Storage temperature	$-40\text{ °C} \dots +70\text{ °C}$	$-40\text{ °C} \dots +70\text{ °C}$
Dimensions (mm) W x H x L	6 x 56 x 91	6 x 56 x 91
Wire connection	Height from upper-edge of DIN 35 rail CAGE CLAMP®	Height from upper-edge of DIN 35 rail CAGE CLAMP®
Cross sections	0.08 mm ² ... 2.5 mm ² / AWG 28 ... 14	0.08 mm ² ... 2.5 mm ² / AWG 28 ... 14
Stripped lengths	5 ... 6 mm / 0.22 in	5 ... 6 mm / 0.22 in
Approvals	VDE 0110 / EN 60664; VDE 0435 / EN 61810-5; UL 508; EEx nC II T4 / DEMKO 02 ATEX 132280U; Ⓢ	DIN VDE 0160 and IEC 60255; VDE 0435 (corresp. parts); DIN VDE 0140, DIN EN 61140; DIN VDE 0115 Part 200; DIN EN 50155; Ⓢ

Relay with 1 changeover contact (1u)
 Contacts 5 μm Au hard gold plated
 with an extended
 Input voltage range: V_N -30 % ... +25 %
 Operating temperature range: -25 °C ... +70 °C
 for normal switching power
 Nominal input voltage V_N 24 V DC

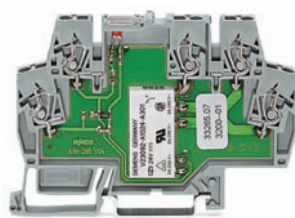
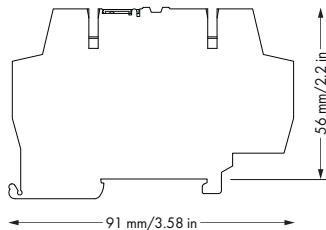

* In order to prevent the gold layer from being damaged these values should not be exceeded. Higher switching power leads to evaporation of the gold layer. The resulting deposits in the enclosure may cause sparkovers between the coil and the contact.

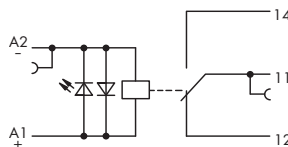

Description	V_N	I_N	Item No.	Pack. Unit
Rail-mounted terminal blocks with miniature switching relay, for DIN 35 rail	24 V DC	10 mA	859-392	1
Technical Data				
Accessories see page 49				
Contact material	AgSnO ₂ + 5 μm Au			
Input voltage range	V_N -30 % ... +25 %			
Max. switching voltage	36 V DC *			
Max. continuous current (terminal blocks in a row)	50 mA *			
Recommended minimum load	10 μA / 100 mV			
Max. switching rate with / without load	6 min ⁻¹ / 20 s ⁻¹			
Operating power	< 320 mW			
Pull-in/drop-out/bounce time typ.	5 ms / 6 ms / 5 ms			
Nominal operating mode	continuous duty			
Dielectric strength contact-coil	4 kV			
Dielectric strength contact-coil (1.2/50 μs)	6 kV			
Surge capacity open contact	1 kV			
Nominal voltage acc. to VDE 01 10 Part 1/4.97, IEC 60664-1	250 V / 4 kV / 3			
Mechanical life	5 x 10 ⁶ switching operations			
Mechanical life at max. load (resistance)	2 x 10 ⁷ switching operations			
Ambient operating temperature (V_N)	-25 °C ... +70 °C			
Storage temperature	-40 °C ... +70 °C			
Dimensions (mm) W x H x L	6 x 56 x 91			
Wire connection	Height from upper-edge of DIN 35 rail CAGE CLAMP®			
Cross sections	0.08 mm ² ... 2.5 mm ² / AWG 28 ... 14			
Stripped lengths	5 ... 6 mm / 0.22 in			
Approvals	VDE 0110 / EN 60664; VDE 0435 / EN 61810-5; VDE 0115 Part 200 / EN 50155; UL 508; EEx nC II T4 / DEMKO 02 ATEX 132280U; Ⓢ			

Rail-Mounted Terminal Blocks with Optocoupler

CAGE CLAMP®

1
39

1

	<p>Optocoupler Input: 5 V DC Output: 60 V DC/100 mA with an extended output voltage and operating temperature range for use in railway traffic</p>	<p>Optocoupler Input: 24 V DC Output: 60 V DC/100 mA with an extended output voltage and operating temperature range for use in railway traffic</p>
--	---	--

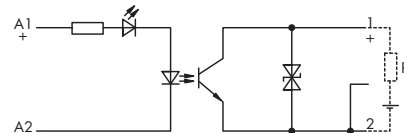
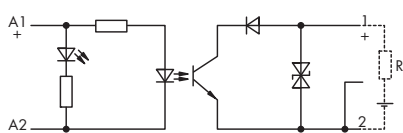
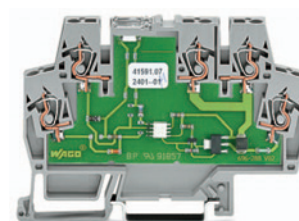
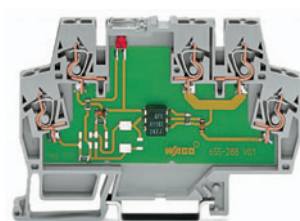
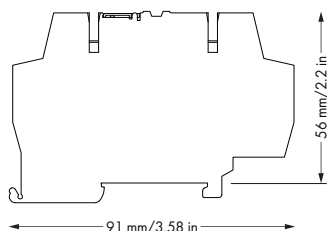

Description	V _N	Item No.	Pack. Unit	V _N	Item No.	Pack. Unit
Rail-mounted terminal blocks with optocoupler, for DIN 35 rail	5 V DC	859-793	1	24 V DC	859-791	1

Technical Data	Accessories see page 49		Accessories see page 49	
Nominal input voltage (V _N)	5 V DC		24 V DC	
Input voltage range low level	0 V ... 0.8 V DC		0 V ... 5 V DC	
Input voltage range high level	2 V ... 6.25 V DC		16 V ... 30 V DC	
Input current range	1.3 mA ... 10 mA DC		2 mA ... 5.5 mA DC	
Current at nominal voltage	7.5 mA DC		4 mA DC	
Output nominal voltage	24 V DC		24 V DC	
Output voltage range	3 V ... 60 V DC		7 V ... 60 V DC	
Max. continuous current (20 °C)	100 mA		100 mA	
Max. continuous current (70 °C)	50 mA		50 mA	
Reverse voltage transistor	100 V		100 V	
Switch on /switch off time	20 µs / 120 µs		20 µs / 120 µs	
Max. operating frequency	1.5 kHz		3 kHz	
Leakage current at nominal voltage	25 µA		30 µA	
Voltage drop at output	≤ 2.5 V		≤ 1.5 V	
Test voltage input / output	2.5 kV eff.		4 kV eff.	
Nominal operating mode	continuous duty		continuous duty	
Ambient operating temperature	-25 °C ... +40 °C		-25 °C ... +40 °C	
Max. operating temperature with reduced current	+70 °C		+70 °C	
Storage temperature	-40 °C ... +70 °C		-40 °C ... +70 °C	
Dimensions (mm) W x H x L	6 x 56 x 91		6 x 56 x 91	
Wire connection	Height from upper-edge of DIN 35 rail CAGE CLAMP®		Height from upper-edge of DIN 35 rail CAGE CLAMP®	
Cross sections	0.08 mm ² ... 2.5 mm ² / AWG 28 ... 14		0.08 mm ² ... 2.5 mm ² / AWG 28 ... 14	
Stripped lengths	5 ... 6 mm / 0.22 in		5 ... 6 mm / 0.22 in	
Approvals	VDE 0110 / EN 60664; VDE 0435 / EN 61810-5; VDE 0115 Part 200 / EN 50155; UL 508; EEx nA II T4 / DEMKO 02 ATEX 132280U		VDE 0110 / EN 60664; VDE 0435 / EN 61810-5; VDE 0115 Part 200 / EN 50155; UL 508; EEx nA II T4 / DEMKO 02 ATEX 132280U	

1 Rail-Mounted Terminal Blocks with Optocoupler

	Optocoupler Input: 24 V DC Output: 24 V DC/100 mA	Optocoupler Input: 5 V DC Output: 24 V DC/100 mA
--	--	---

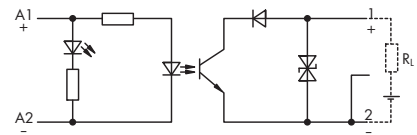
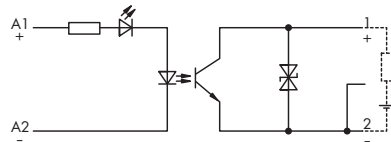
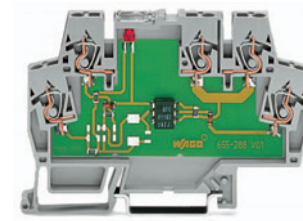
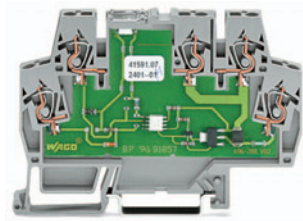
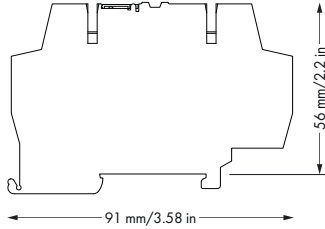

Description	V _N	Item No.	Pack. Unit	V _N	Item No.	Pack. Unit
Rail-mounted terminal blocks with optocoupler, for DIN 35 rail	24 V DC	859-796	1	5 V DC	859-795	1

Technical Data	Accessories see page 49		Accessories see page 49	
Nominal input voltage (V _N)	24 V DC		5 V DC	
Input voltage range low level	0 V ... 5 V DC		0 V ... 0.8 V DC	
Input voltage range high level	18 V ... 30 V DC		2 V ... 6.25 V DC	
Input current range	3.8 mA ... 12.5 mA DC		3.8 mA ... 23 mA DC	
Current at nominal voltage	9.2 mA DC		17.5 mA DC	
Output nominal voltage	24 V DC		24 V DC	
Output voltage range	3 V ... 30 V DC		3 V ... 30 V DC	
Max. continuous current (20 °C)	100 mA		100 mA	
Max. continuous current (70 °C)	50 mA		50 mA	
Reverse voltage transistor	65 V		65 V	
Switch on /switch off time	10 μs / 50 μs		10 μs / 50 μs	
Max. operating frequency	10 kHz		10 kHz	
Leakage current at nominal voltage	25 μA		25 μA	
Voltage drop at output	≤ 1 V		≤ 1 V	
Test voltage input / output	2.5 kV eff.		2.5 kV eff.	
Nominal operating mode	continuous duty		continuous duty	
Ambient operating temperature	-25 °C ... +40 °C		-25 °C ... +40 °C	
Max. operating temperature with reduced current	+70 °C		+70 °C	
Storage temperature	-40 °C ... +70 °C		-40 °C ... +70 °C	
Dimensions (mm) W x H x L	6 x 56 x 91		6 x 56 x 91	
Wire connection	Height from upper-edge of DIN 35 rail CAGE CLAMP®		Height from upper-edge of DIN 35 rail CAGE CLAMP®	
Cross sections	0.08 mm ² ... 2.5 mm ² / AWG 28 ... 14		0.08 mm ² ... 2.5 mm ² / AWG 28 ... 14	
Stripped lengths	5 ... 6 mm / 0.22 in		5 ... 6 mm / 0.22 in	
Approvals	VDE 0110 / EN 60664; VDE 0435 / EN 61810-5; UL 508; EEx nA II T4 / DEMKO 02 ATEX 132280U		VDE 0110 / EN 60664; VDE 0435 / EN 61810-5; UL 508; EEx nA II T4 / DEMKO 02 ATEX 132280U	

	Optocoupler Input: 24 V DC Output: 24 V DC/100 mA	Optocoupler Input: 24 V DC Output: 24 V DC/3 A Negative switching
--	--	--

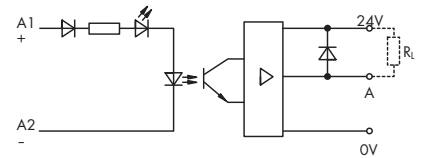
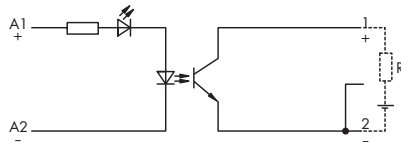
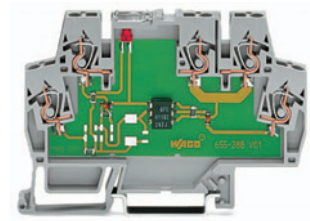
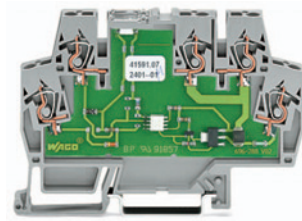
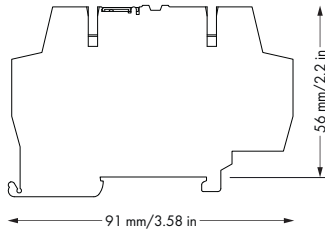

Description	V _N	Item No.	Pack. Unit	V _N	Item No.	Pack. Unit
Rail-mounted terminal blocks with optocoupler, for DIN 35 rail	24 V DC	859-794	1	24 V DC	859-720	1

Technical Data	Accessories see page 49		Accessories see page 49	
Nominal input voltage (V _N)	24 V DC		24 V DC	
Input voltage range			16 V ... 30 V DC	
Input voltage range low level	0 V ... 5 V DC			
Input voltage range high level	16 V ... 30 V DC			
Input current range	2 mA ... 5.5 mA DC		2.5 mA ... 5.5 mA DC	
Current at nominal voltage	4.2 mA DC		4 mA DC	
Output nominal voltage	24 V DC		24 V DC	
Output voltage range	9 V ... 60 V DC		10 V ... 30 V DC	
Max. continuous current			3 A	
Max. continuous current (20 °C)	100 mA			
Max. continuous current (70 °C)	50 mA			
Peak output current			20 A	
Reverse voltage transistor	100 V		55 V	
Switch on /switch off time	20 µs / 120 µs		25 µs / 75 µs	
Max. operating frequency	1.5 kHz			
Switching frequency			f < 500 Hz	
IL < 2 A / IL < 1 A / IL < 500 mA			f < 1 kHz / f < 2 kHz / f < 3 kHz	
Leakage current at nominal voltage	25 µA		< 25 µA	
Collector / emitter voltage drop V _{ce sat}			≤ 0.5 V	
Voltage drop at output	≤ 2 V			
Test voltage input / output	2.5 kV eff.		2.5 kV eff.	
Nominal operating mode	continuous duty		continuous duty	
Ambient operating temperature	-25 °C ... +40 °C		-25 °C ... +40 °C	
Storage temperature	-40 °C ... +70 °C		-40 °C ... +70 °C	
Dimensions (mm) W x H x L	6 x 56 x 91		6 x 56 x 91	
Wire connection	Height from upper-edge of DIN 35 rail CAGE CLAMP®		Height from upper-edge of DIN 35 rail CAGE CLAMP®	
Cross sections	0.08 mm ² ... 2.5 mm ² / AWG 28 ... 14		0.08 mm ² ... 2.5 mm ² / AWG 28 ... 14	
Stripped lengths	5 ... 6 mm / 0.22 in		5 ... 6 mm / 0.22 in	
Approvals	VDE 0110 / EN 60664; VDE 0435 / EN 61810-5; UL 508; EEx nA II T4 / DEMKO 02 ATEX 132280U		VDE 0110 / EN 60664; VDE 0435 / EN 61810-5; UL 508; EEx nA II T4 / DEMKO 02 ATEX 132280U	

1 Rail-Mounted Terminal Blocks with Optocoupler

42

	Optocoupler Input: 24 V DC Output: 24 V DC/3 A	Optocoupler Input: 24 V DC Output: 3V ... 30 V DC/3A 3 A power optocoupler
--	---	---

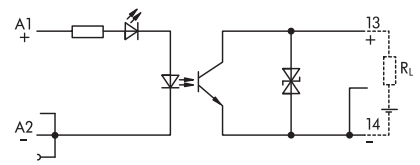
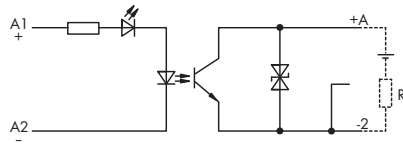
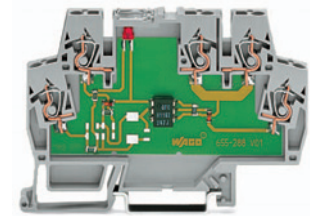
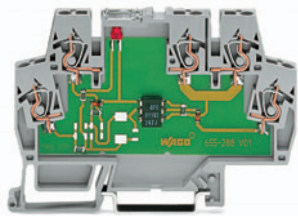
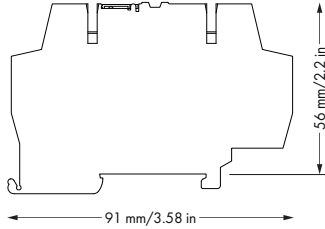

Description	V _N	Item No.	Pack. Unit	V _N	Item No.	Pack. Unit
Rail-mounted terminal blocks with optocoupler, for DIN 35 rail	24 V DC	859-730	1	24 V DC	859-740	1

Technical Data	Accessories see page 49		Accessories see page 49	
Nominal input voltage (V _N)	24 V DC		24 V DC	
Input voltage range low level	0 V ... 5 V DC		0 V ... 9 V DC	
Input voltage range high level	15 V ... 27 V DC		19 V ... 27 V DC	
Current at nominal voltage	14 mA DC		7 mA DC	
Input wiring	Status LED (red)		status indication LED (yellow), reverse voltage protection	
Output circuit	2-wire, isolated		2-wire, isolated, overvoltage protection	
Output nominal voltage	24 V DC		24 V DC	
Output voltage range	3 V ... 30 V DC		3 V ... 30 V DC	
Max. continuous current	3 A		3 A	
Peak output current	25 A		25 A	
Reverse voltage transistor	55 V			
Voltage drop	< 0.4 V		< 0.2 V	
Switch on /switch off time	25 μs / 450 μs		25 μs / 450 μs	
Switching frequency	f < 350 Hz		f < 350 Hz	
Test voltage input / output	2.5 kV eff.		2.5 kV eff.	
Nominal operating mode	continuous duty		continuous duty	
Ambient operating temperature	-25 °C ... +55 °C		-25 °C ... +55 °C	
Storage temperature	-40 °C ... +70 °C		-40 °C ... +70 °C	
Dimensions (mm) W x H x L	6 x 56 x 91		6 x 56 x 91	
Wire connection	Height from upper-edge of DIN 35 rail CAGE CLAMP®		Height from upper-edge of DIN 35 rail CAGE CLAMP®	
Cross sections	0.08 mm ² ... 2.5 mm ² / AWG 28 ... 14		0.08 mm ² ... 2.5 mm ² / AWG 28 ... 14	
Stripped lengths	5 ... 6 mm / 0.22 in		5 ... 6 mm / 0.22 in	
Approvals	VDE 0110 / EN 60664; VDE 0435 / EN 61810-5; UL 508; EEx nA II T4 / DEMKO 02 ATEX 132280U		IEC 60664 / IEC 60664A / DIN VDE 0110; degree of pollution 2, overvoltage category III	

	<p>Optocoupler Input: 230 V AC Output: 24 V DC/0.5 A Positive switching increased input frequency up to 100 Hz Input voltage up to 270 V AC</p>	<p>Optocoupler Input: 230 V DC Output: 24 V DC/0.5 A Negative switching</p>
--	--	--

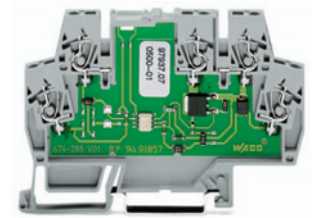
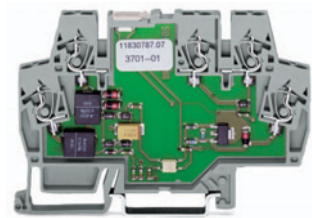
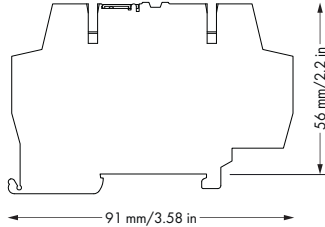

859-772

- Increased input frequency up to 100 Hz
- Input voltage up to 270 V AC

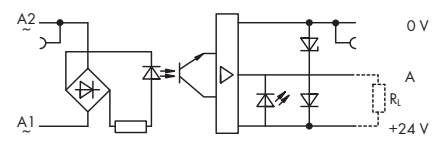
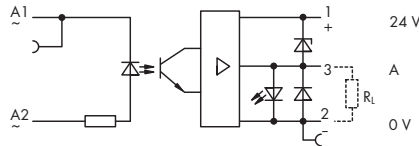

Description	V _N	Item No.	Pack. Unit	V _N	Item No.	Pack. Unit
Rail-mounted terminal blocks with optocoupler, for DIN 35 rail	230 V AC	859-772	1	230 V AC	859-712	1

Technical Data

Accessories see page 49

Accessories see page 49

Nominal input voltage (V _N)	230 V AC / 50 Hz ... 60 Hz	230 V AC
Input voltage range low level	0 V ... 90 V AC	0 V ... 90 V AC
Input voltage range high level	175 V ... 270 V AC	175 V ... 250 V AC
Input current range	0.04 mA ... 0.7 mA	0.4 mA ... 0.7 mA
Current at nominal voltage	0.6 mA	0.6 mA
Input wiring	Varistor 300 V	Varistor 300 V
Output circuit	Protection diode, operation indicator	Protection diode, operation indicator LED (red)
Output nominal voltage	24 V DC	24 V DC
Output voltage range	20 V ... 30 V DC	20 V ... 30 V DC
Max. continuous current	500 mA	500 mA
Reverse voltage transistor	80 V	80 V
Switch on /switch off time	< 30 ms / < 30 ms	< 30 ms / < 30 ms
Leakage current at nominal voltage	10 µA	10 µA
Collector / emitter voltage drop V _{ce sat}	< 1.2 V	< 1.2 V
Max. output (reverse current)	12 mA	11 mA
Test voltage input / output	2.5 kV eff.	2.5 kV eff.
Nominal operating mode	continuous duty	continuous duty
Ambient operating temperature	-25 °C ... +55 °C	-25 °C ... +55 °C
Storage temperature	-40 °C ... +70 °C	-40 °C ... +70 °C
Dimensions (mm) W x H x L	6 x 56 x 91	6 x 56 x 91
Wire connection	Height from upper-edge of DIN 35 rail	Height from upper-edge of DIN 35 rail
Cross sections	0.08 mm ² ... 2.5 mm ² / AWG 28 ... 14	0.08 mm ² ... 2.5 mm ² / AWG 28 ... 14
Stripped lengths	5 ... 6 mm / 0.22 in	5 ... 6 mm / 0.22 in
Approvals	VDE 0110 / EN 60664; UL 508; EEx nA II T4 / DEMKO 02 ATEX 132280U	VDE 0110 / EN 60664; UL 508; EEx nA II T4 / DEMKO 02 ATEX 132280U

1 Rail-Mounted Terminal Blocks with Optocoupler

	Optocoupler Input: 5 V DC Output: 24 V DC/0.5A/25 kHz Negative switching	Optocoupler Input: 24 V DC Output: 24 V DC/0.5A/25 kHz Negative switching
--	---	--

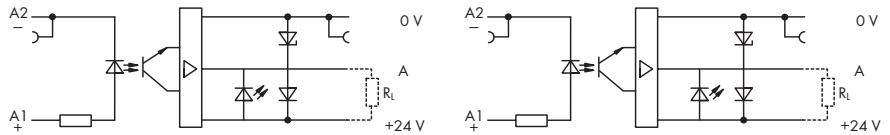
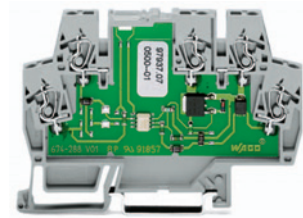
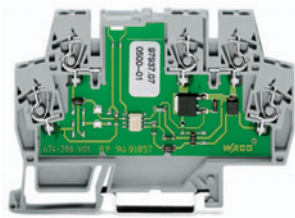
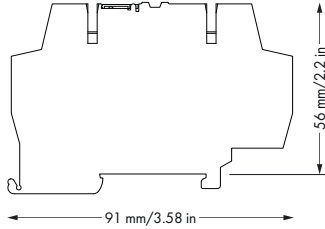

Description	V _N	Item No.	Pack. Unit	V _N	Item No.	Pack. Unit
Rail-mounted terminal blocks with optocoupler, for DIN 35 rail	5 V DC	859-702	1	24 V DC	859-708	1

Technical Data	Accessories see page 49		Accessories see page 49	
Nominal input voltage (V _N)	5 V DC		24 V DC	
Input voltage range low level	0 V ... 1 V DC		0 V ... 5 V DC	
Input voltage range high level	4 V ... 6.25 V DC		19 V ... 30 V DC	
Input current range	7 mA ... 13 mA		5.7 mA ... 10.2 mA	
Current at nominal voltage	9.6 mA DC		7.7 mA DC	
Input wiring	Reverse voltage protection			
Output circuit	Protection diode, operation indicator LED (red)		Protection diode, operation indicator LED (red)	
Output nominal voltage	24 V DC		24 V DC	
Output voltage range	20 V ... 30 V DC		20 V ... 30 V DC	
Max. continuous current	500 mA		500 mA	
Reverse voltage transistor	80 V		80 V	
Switch on /switch off time	< 7 μs / < 15 μs		< 10 μs / < 10 μs	
Max. operating frequency	10 kHz		10 kHz	
Leakage current at nominal voltage	< 10 μA		< 10 μA	
Collector / emitter voltage drop V _{ce sat}	< 1.2 V		< 1.2 V	
Max. output (reverse current)	11 mA		11 mA	
Test voltage input / output	2.5 kV eff.		2.5 kV eff.	
Nominal operating mode	continuous duty		continuous duty	
Ambient operating temperature	-25 °C ... +55 °C		-25 °C ... +55 °C	
Storage temperature	-40 °C ... +70 °C		-40 °C ... +70 °C	
Dimensions (mm) W x H x L	6 x 56 x 91		6 x 56 x 91	
Wire connection	Height from upper-edge of DIN 35 rail CAGE CLAMP®		Height from upper-edge of DIN 35 rail CAGE CLAMP®	
Cross sections	0.08 mm ² ... 2.5 mm ² / AWG 28 ... 14		0.08 mm ² ... 2.5 mm ² / AWG 28 ... 14	
Stripped lengths	5 ... 6 mm / 0.22 in		5 ... 6 mm / 0.22 in	
Approvals	VDE 0110 / EN 60664; UL 508; EEx nA II T4 / DEMKO 02 ATEX 132280U		VDE 0110 / EN 60664; UL 508; EEx nA II T4 / DEMKO 02 ATEX 132280U	

	Optocoupler Input: 24 V DC Output: 5 V DC/0.5A/25 kHz Negative switching	Optocoupler Input: 5 V DC Output: 24 V DC/0.5 A/10 kHz Positive switching
--	---	--

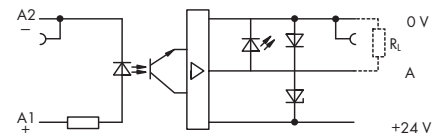
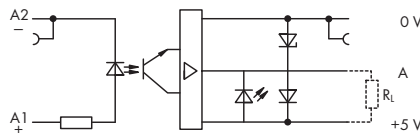
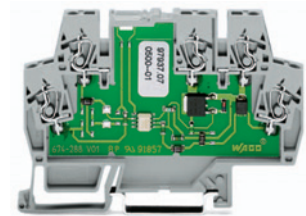
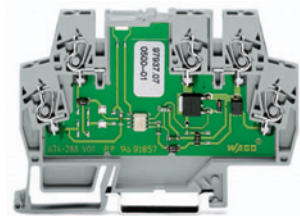
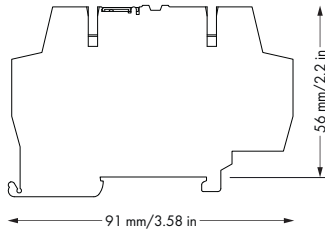

Description	V _N	Item No.	Pack. Unit	V _N	Item No.	Pack. Unit
Rail-mounted terminal blocks with optocoupler, for DIN 35 rail	24 V DC	859-706	1	5 V DC	859-752	1

Technical Data		Accessories see page 49		Accessories see page 49	
Nominal input voltage (V _N)	24 V DC			5 V DC	
Input voltage range low level	0 V ... 5 V DC			0 V ... 1 V DC	
Input voltage range high level	18 V ... 30 V DC			4 V ... 6 V DC	
Input current range	8 mA ... 14 mA			7 mA ... 13 mA	
Current at nominal voltage	11 mA DC			10 mA	
Input wiring	Reverse voltage protection			Reverse voltage protection	
Output circuit	Protection diode, operation indicator LED (red)			Protection diode, operation indicator LED (red)	
Output nominal voltage	5 V DC			24 V DC	
Output voltage range	4 V ... 6.25 V DC			20 V ... 30 V DC	
Max. continuous current	500 mA			500 mA	
Reverse voltage transistor	80 V			80 V	
Switch on /switch off time	< 7 μs / < 15 μs			< 15 μs / < 30 μs	
Max. operating frequency	10 kHz			10 kHz	
Leakage current at nominal voltage	< 10 μA			< 10 μA	
Collector / emitter voltage drop V _{ce sat}	< 1.2 V			< 1.2 V	
Max. output (reverse current)	7 mA			12.5 mA	
Test voltage input / output	2.5 kV eff.			2.5 kV eff.	
Nominal operating mode	continuous duty			continuous duty	
Ambient operating temperature	-25 °C ... +55 °C			-25 °C ... +40 °C	
Storage temperature	-40 °C ... +70 °C			-40 °C ... +70 °C	
Dimensions (mm) W x H x L	6 x 56 x 91			6 x 56 x 91	
Wire connection	Height from upper-edge of DIN 35 rail CAGE CLAMP®			Height from upper-edge of DIN 35 rail CAGE CLAMP®	
Cross sections	0.08 mm ² ... 2.5 mm ² / AWG 28 ... 14			0.08 mm ² ... 2.5 mm ² / AWG 28 ... 14	
Stripped lengths	5 ... 6 mm / 0.22 in			5 ... 6 mm / 0.22 in	
Approvals	VDE 0110 / EN 60664; UL 508; EEx nA II T4 / DEMKO 02 ATEX 132280U			VDE 0110 / EN 60664; UL 508; EEx nA II T4 / DEMKO 02 ATEX 132280U	

1 Rail-Mounted Terminal Blocks with Optocoupler

	Optocoupler Input: 24 V DC Output: 24 V DC/0.5 A/10 kHz Positive switching	Optocoupler Input: 24 V DC Output: 5 V DC/0.5 A/10 kHz Positive switching
--	---	--

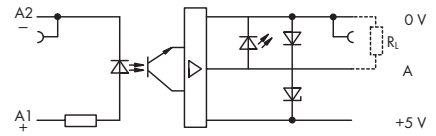
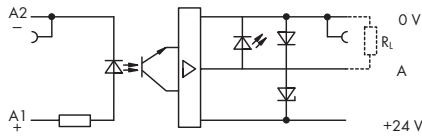
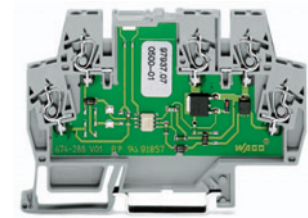
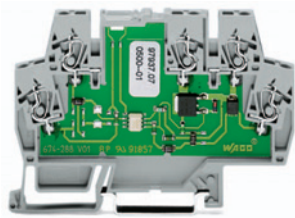
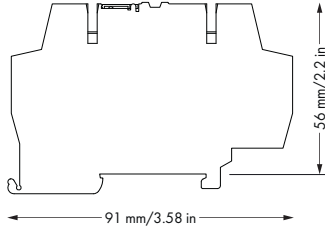

Description	V _N	Item No.	Pack. Unit	V _N	Item No.	Pack. Unit
Rail-mounted terminal blocks with optocoupler, for DIN 35 rail	24 V DC	859-758	1	24 V DC	859-756	1

Technical Data	Accessories see page 49		Accessories see page 49	
Nominal input voltage (V _N)	24 V DC		24 V DC	
Input voltage range low level	0 V ... 5 V DC		0 V ... 5 V DC	
Input voltage range high level	18 V ... 30 V DC		18 V ... 30 V DC	
Input current range	5.5 mA ... 10.6 mA		8 mA ... 14.5 mA	
Current at nominal voltage	8 mA		11 mA	
Input wiring	Reverse voltage protection		Reverse voltage protection	
Output circuit	Protection diode, operation indicator LED (red)		Protection diode, operation indicator LED (red)	
Output nominal voltage	24 V DC		5 V DC	
Output voltage range	20 V ... 30 V DC		4 V ... 6.25 V DC	
Max. continuous current	500 mA		500 mA	
Reverse voltage transistor	80 V		80 V	
Switch on /switch off time	< 15 μs / < 30 μs		< 15 μs / < 30 μs	
Max. operating frequency	10 kHz		10 kHz	
Leakage current at nominal voltage	< 10 μA		< 10 μA	
Collector / emitter voltage drop V _{ce sat}	< 1.2 V		< 1.2 V	
Max. output (reverse current)	11 mA		4.5 mA	
Test voltage input / output	2.5 kV eff.		2.5 kV eff.	
Nominal operating mode	continuous duty		continuous duty	
Ambient operating temperature	-25 °C ... +40 °C		-25 °C ... +40 °C	
Storage temperature	-40 °C ... +70 °C		-40 °C ... +70 °C	
Dimensions (mm) W x H x L	6 x 56 x 91		6 x 56 x 91	
Wire connection	Height from upper-edge of DIN 35 rail CAGE CLAMP®		Height from upper-edge of DIN 35 rail CAGE CLAMP®	
Cross sections	0.08 mm ² ... 2.5 mm ² / AWG 28 ... 14		0.08 mm ² ... 2.5 mm ² / AWG 28 ... 14	
Stripped lengths	5 ... 6 mm / 0.22 in		5 ... 6 mm / 0.22 in	
Approvals	VDE 0110 / EN 60664; UL 508; EEx nA II T4 / DEMKO 02 ATEX 132280U		VDE 0110 / EN 60664; UL 508; EEx nA II T4 / DEMKO 02 ATEX 132280U	

	Optocoupler Input: 5 V DC Output: 230 V AC/0.5 A	
--	---	--

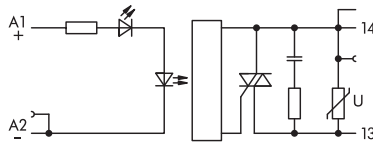
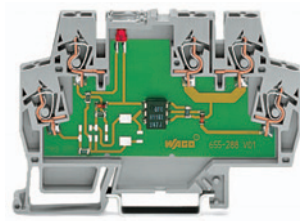
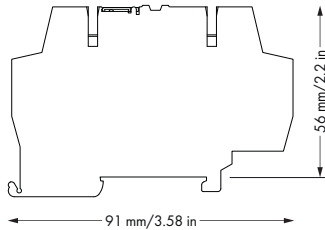

Description	V _N	Item No.	Pack. Unit
Rail-mounted terminal blocks with optocoupler, for DIN 35 rail	5 V DC	859-902	1

Technical Data

Accessories see page 49

Nominal input voltage (V _N)	5 V DC
Input voltage range low level	0 V ... 1 V DC
Input voltage range high level	4 V ... 6.25 V DC
Input current range	DC 5.6 mA ... 10.3 mA
Current at nominal voltage	7.7 mA DC
Input wiring	Reverse voltage protection
Output circuit	varistor /RC module
Output nominal voltage	230 V AC
Output voltage range	24 V ... 260 V AC (50 Hz ... 60 Hz)
Max. continuous current (20 °C)	500 mA
Surge current (t=20 ms)	30 A
Min. load current	50 mA
Peak reverse voltage Triac	600 V
Switch on /switch off time	10 ms / 10 ms (1 half-wave)
Leakage current at nominal voltage	< 1 mA
Voltage drop at output	< 1 V
Test voltage input / output	2.5 kV eff.
Nominal operating mode	continuous duty
Ambient operating temperature	-25 °C ... +55 °C
Storage temperature	-40 °C ... +70 °C
Dimensions (mm) W x H x L	6 x 56 x 91
Wire connection	Height from upper-edge of DIN 35 rail CAGE CLAMP®
Cross sections	0.08 mm ² ... 2.5 mm ² / AWG 28 ... 14
Stripped lengths	5 ... 6 mm / 0.22 in
Approvals	IEC 60664 / IEC 60664A / DIN VDE 0110; degree of pollution 2, overvoltage category III

Rail-Mounted Terminal Blocks with Miniature Switching Relays and Optocouplers

with an extended input voltage and operating temperature range V_N -30 % ... +25 % Ambient operating temperature -25 °C ... +70 °C

Rail-mounted terminal blocks with miniature switching relay

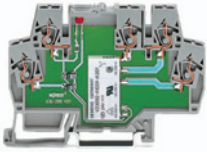

Rail-mounted terminal blocks with optocouplers

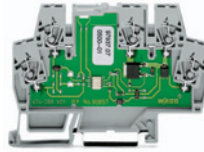

Description	Nominal input voltage (V_N)	Input voltage range	Max. switching capacity	Ambient operating temperature (V_N)	Item No.	Pack. Unit
Relay with 1 changeover contact	115 V DC	V_N -30 % ... +25 %	Contact 5 μ m Au	-25 °C ... +70 °C	859-317	1
Relay with 1 changeover contact	48 V DC	V_N -30 % ... +25 %	Contact 5 μ m Au	-25 °C ... +70 °C	859-384	1
Relay with 1 changeover contact	36 V DC	V_N -40 % ... +25 %	Contact 5 μ m Au	-25 °C ... +70 °C	859-386	1
Relay with 1 changeover contact	24 V DC	V_N -30 % ... +25 %	250 V AC / 3 A	-25 °C ... +70 °C	859-390	1
Relay with 1 changeover contact	110 V DC	$V_N \pm 30$ %	250 V AC / 3 A	-25 °C ... +70 °C	859-391	1
Relay with 1 changeover contact	24 V DC	V_N -30 % ... +25 %	Contact 5 μ m Au	-25 °C ... +70 °C	859-392	1
Relay with 1 changeover contact	72 V DC	V_N -30 % ... +25 %	250 V AC / 3 A	-25 °C ... +70 °C	859-393	1
Relay with 1 changeover contact	36 V DC	V_N -30 % ... +25 %	250 V AC / 3 A	-25 °C ... +70 °C	859-394	1
Relay with 1 changeover contact	48 V DC	$V_N \pm 40$ %	250 V AC / 3 A	-25 °C ... +70 °C	859-397	1
Relay with 1 changeover contact	24 V DC	$V_N \pm 40$ %	250 V AC / 3 A	-25 °C ... +70 °C	859-398	1
Relay with 1 changeover contact	110 V DC	$V_N \pm 40$ %	250 V AC / 3 A	-25 °C ... +70 °C	859-399	1
Optocoupler, 2-wire output	24 V DC	V_N -25 % ... +25 %	3 V ... 60 V DC / 50 mA	-25 °C ... +70 °C	859-794	1

For additional technical data see: www.wago.com

Accessories, 859 Series

Operating tool



Wire connection

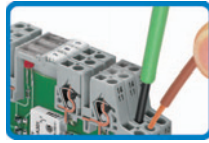

Marking pen with fibre tip



Test pin



End and intermediate plate



Description		Item No.	Pack. Unit
End and intermediate plate; 1 mm / 0.039 in thick, gray		859-525	100 (4x25)
Test pin; Ø 1 mm / 0.039 in; test wire for sold. onto test plug		859-500	1 (1x1)
Marking pen	for permanent marking	210-110	1
Operating tool, with partially insulated shaft	Type 2, blade (3.5 x 0.5) mm	210-720	1

Push-in type jumper bar



Commoning

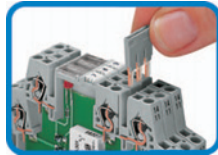

Description		Item No.	Pack. Unit
Push-in type jumper bars, light gray, insulated, 18 A	2-way	859-402	200 (8x25)
	3-way	859-403	200 (8x25)
	4-way	859-404	200 (8x25)
	5-way	859-405	200 (8x25)
	6-way	859-406	100 (4x25)
	7-way	859-407	100 (4x25)
	8-way	859-408	100 (4x25)
	9-way	859-409	100 (4x25)
	10-way	859-410	100 (4x25)
	Item no. suffix for colored push-in type jumper bars	yellow	... /000-029
red		... /000-005	
blue		... /000-006	

Miniature quick marking card



Marking



Description		Item No.	Pack. Unit
Miniature WSB Quick marking system	plain	248-501	5 cards
Marking software and printer/plotter see Section 8			
Marking	1 ... 10 (10 x)	248-502	5 cards
	11 ... 20 (10x)	248-503	5 cards
	21 ... 30 (10x)	248-504	5 cards
	31 ... 40 (10x)	248-505	5 cards
	41 ... 50 (10 x)	248-506	5 cards
	1 ... 50 (2 x)	248-566	5 cards
	K 1 ... K 10 (10 x)	248-450	5 cards
	K 11 ... K 20 (10 x)	248-451	5 cards
	K 100 (10 x)	248-452	5 cards
	U 1 ... U 10 (10 x)	248-453	5 cards
U 11 ... U 20 (10 x)	248-454	5 cards	
	U 100 (10 x)	248-455	5 cards
10 strips with 10 markers, white with black printing			

	Relay with 1 changeover contact (1u) for normal switching power Nominal input voltage V_N 12 V, 24 V, 48 V, 60 V, 110 V, 220 V DC	Relay with 1 changeover contact (1u) for normal switching power Nominal input voltage V_N 24 V, 115 V, 230 V AC/DC
--	---	--

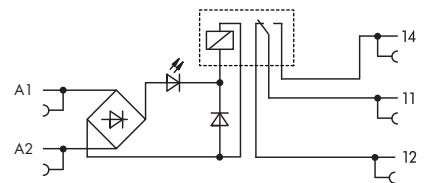
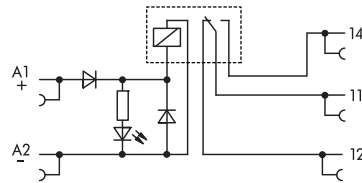
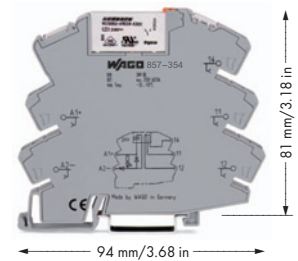
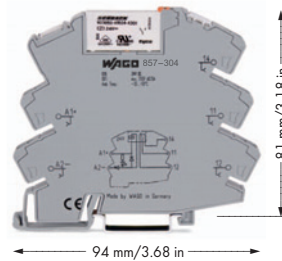
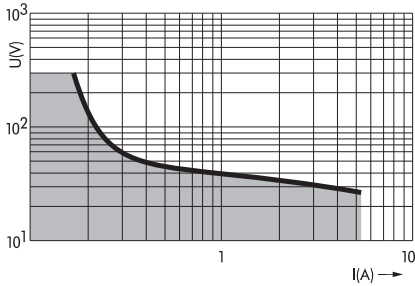

Note: Inductive loads have to be attenuated by an appropriate protective circuit in order to protect relay coils and contacts.

Description	V_N	I_N	Item No.	Pack. Unit	V_N	I_N	Item No.	Pack. Unit
JUMPFLEX® relay socket with miniature switching relay, for DIN 35 rail	12 V DC	17 mA	857-303	1	24 V AC/DC	8.5 mA	857-354	1
	24 V DC	10 mA	857-304	1	115 V AC/DC	4 mA	857-357	1
	48 V DC	6.5 mA	857-305	1	230 V AC/DC	3.5 mA	857-358	1
	60 V DC	5.2 mA	857-306	1				
	110 V DC	3.5 mA	857-307	1				
	220 V DC	3.2 mA	857-308	1				

Technical Data	Accessories see page 52 ... 55 + 63	Accessories see page 52 ... 55 + 63
Contact material	AgSnO ₂	AgSnO ₂
Input voltage range	V_N -15 % ... +20 %	V_N -15 % ... +20 % (857-354/857-357) V_N -15 % ... +10 % (857-358)
Max. switching voltage	250 V AC	250 V AC
Max. continuous current (terminal blocks in a row)	6 A	6 A
Max. switching power (resistive)	1250 VA AC; DC see load limit curve	1250 VA AC; DC see load limit curve
Recommended minimum load	≥ 100 mA / 12 V AC/DC	≥ 100 mA / 12 V AC/DC
Max. switching rate with / without load	6 min ⁻¹ / 20 s ⁻¹	6 min ⁻¹ / 20 s ⁻¹
Operating power	< 300 mW / < 700 mW	< 300 mVA / < 800 mVA
Pull-in/drop-out/bounce time typ.	5 ms / 6 ms / 5 ms	5 ms / 6 ms / 5 ms
Nominal operating mode	continuous duty	continuous duty
Dielectric strength contact-coil	4 kV _{eff}	4 kV _{eff}
Surge capacity open contact	1 kV _{eff}	1 kV _{eff}
Nominal voltage acc. to VDE 0110 Part 1/4.97, IEC 60664-1	250 V / 4 kV / 3	250 V / 4 kV / 3
Mechanical life	5 × 10 ⁶ switching operations	5 × 10 ⁶ switching operations
Mechanical life at max. load (resistance)	5 × 10 ⁴ switching operations	5 × 10 ⁴ switching operations
Ambient operating temperature (V_N)	-25 °C ... +60 °C	-25 °C ... +60 °C
Storage temperature	-40 °C ... +70 °C	-40 °C ... +70 °C
Dimensions (mm) W x H x L	6 x 81 x 94	6 x 81 x 94
Wire connection	Height from upper-edge of DIN 35 rail CAGE CLAMP®S	Height from upper-edge of DIN 35 rail CAGE CLAMP®S
Cross sections	solid: 0.08 mm ² ... 2.5 mm ² / AWG 28 ... 12 fine-stranded: 0.34 mm ² ... 2.5 mm ² / AWG 22 ... 12	solid: 0.08 mm ² ... 2.5 mm ² / AWG 28 ... 12 fine-stranded: 0.34 mm ² ... 2.5 mm ² / AWG 22 ... 12
Stripped lengths	9 ... 10 mm / 0.37 in	9 ... 10 mm / 0.37 in
Approvals	VDE 0110 / EN 60664; VDE 0435 / EN 61810-1; Ⓢ	VDE 0110 / EN 60664; VDE 0435 / EN 61810-1; Ⓢ (857-358: Ⓢ pending)

	Relay with 1 changeover contact (1u) (gold contacts) for normal switching power Nominal input voltage V_N 24 V, 110 V, 220 V DC	Relay with 1 changeover contact (1u) (gold contacts) for normal switching power Nominal input voltage V_N 24 V, 115 V, 230 V AC/DC
--	--	---

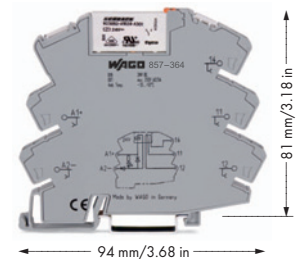
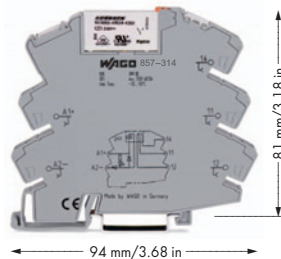
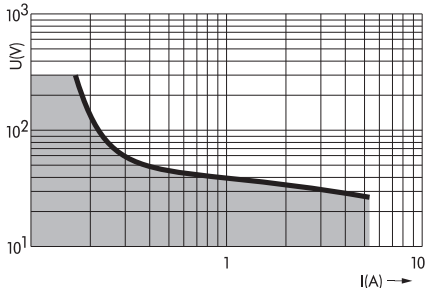

* In order to prevent the gold layer from being damaged these values should not be exceeded. Higher switching power leads to evaporation of the gold layer. The resulting deposits in the enclosure may cause sparkovers between the coil and the contact.

The values in brackets are valid if the gold layer is damaged.

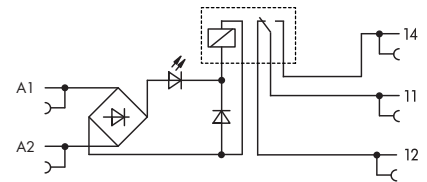
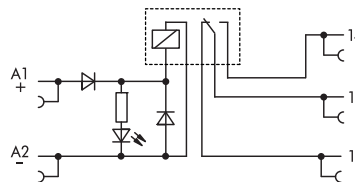

Description	V _N	I _N	Item No.	Pack. Unit	V _N	I _N	Item No.	Pack. Unit
JUMPFLEX® relay socket with miniature switching relay, for DIN 35 rail	24 V DC	10 mA	857-314	1	24 V AC/DC	8.5 mA	857-364	1
	110 V DC	3.5 mA	857-317	1	115 V AC/DC	4 mA	857-367	1
	220 V DC	3.2 mA	857-318	1	230 V AC/DC	3.5 mA	857-368	1

Technical Data

Accessories see page 52 ... 55 + 63

Accessories see page 52 ... 55 + 63

Contact material	AgSnO ₂ + 5 μ Au	AgSnO ₂ + 5 μ Au
Input voltage range	V _N -15 % ... +20 %	V _N -15 % ... +20 % (857-364/857-367) V _N -15 % ... +10 % (857-368)
Max. switching voltage	36 V* DC / (250 V AC/DC)	(250 V AC/DC)*
Max. continuous current (terminal blocks in a row)	50 mA* / (6 A)	50 mA* / (6 A)
Max. Switching power (resistive)	(1250 VA AC; DC see load limit curve)	(1250 VA AC; DC see load limit curve)
Recommended minimum load	≥ 1 V / 1 mA / 50 mW	≥ 1 V / 1 mA / 50 mW
Max. switching rate with / without load	6 min ⁻¹ / 20 s ⁻¹	6 min ⁻¹ / 20 s ⁻¹
Operating power	< 300 mW / < 700 mW	< 300 mVA / < 800 mVA
Pull-in/drop-out/bounce time typ.	5 ms / 6 ms / 5 ms	5 ms / 6 ms / 5 ms
Nominal operating mode	continuous duty	continuous duty
Dielectric strength contact-coil	4 kV _{eff}	4 kV _{eff}
Surge capacity open contact	1 kV _{eff}	1 kV _{eff}
Nominal voltage acc. to VDE 0110 Part 1/4.97, IEC 60664-1	250 V / 4 kV / 3	250 V / 4 kV / 3
Mechanical life	5 × 10 ⁶ switching operations	5 × 10 ⁶ switching operations
Mechanical life at max. load (resistance)	5 × 10 ⁴ switching operations	5 × 10 ⁴ switching operations
Ambient operating temperature (V _N)	-25 °C ... +60 °C	-25 °C ... +60 °C
Storage temperature	-40 °C ... +70 °C	-40 °C ... +70 °C
Dimensions (mm) W x H x L	6 x 81 x 94	6 x 81 x 94
Wire connection	Height from upper-edge of DIN 35 rail CAGE CLAMP®S	Height from upper-edge of DIN 35 rail CAGE CLAMP®S
Cross sections	solid: 0.08 mm ² ... 2.5 mm ² / AWG 28 ... 12 fine-stranded: 0.34 mm ² ... 2.5 mm ² / AWG 22 ... 12	solid: 0.08 mm ² ... 2.5 mm ² / AWG 28 ... 12 fine-stranded: 0.34 mm ² ... 2.5 mm ² / AWG 22 ... 12
Stripped lengths	9 ... 10 mm / 0.37 in	9 ... 10 mm / 0.37 in
Approvals	VDE 0110 / EN 60664; VDE 0435 / EN 61810-1; Ⓢ	VDE 0110 / EN 60664; VDE 0435 / EN 61810-1; Ⓢ (857-368: Ⓢ pending)

1 Miniature Switching Relay, Series 857

	Pluggable miniature switching relays 1 changeover contact	Pluggable miniature switching relays 1 changeover contact (gold contacts)
--	--	---

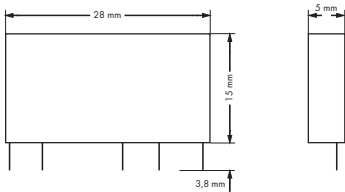

* In order to prevent the gold layer from being damaged these values should not be exceeded. Higher switching power leads to evaporation of the gold layer. The resulting deposits in the enclosure may cause sparkovers between the coil and the contact.

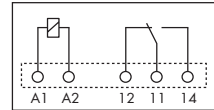
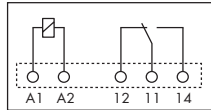

The values in brackets are valid if the gold layer is damaged.

Description	V _N	Item No.	Pack. Unit	V _N	Item No.	Pack. Unit
Pluggable miniature switching relays	12 V DC	857-150	20			
	24 V DC	857-152	20	24 V DC	857-153	20
The 60 V DC replacement relays must be used with 60 V DC, 110 V DC, 220 V DC and 115 V AC/DC, 230 V AC/DC relay modules.	60 V DC	857-155	20	60 V DC	857-157	20

Technical Data

	Standard	Gold Contact
Contact material	AgSnO ₂	AgSnO ₂ + 5 μ Au
Max. switching voltage	250 V AC/DC	36 V* DC / (250 V AC/DC)
Max. continuous current (terminal blocks in a row)	6 A	50 mA* / (6 A)
Max. Switching power (resistive)	1250 VA AC	(1250 VA AC)*
Recommended minimum load	≥ 100 mA / 12 V AC/DC	≥ 1 V / 1 mA / 50 mW
Max. switching rate with / without load	6 min ⁻¹ / 20 s ⁻¹	6 min ⁻¹ / 20 s ⁻¹
Rated power consumption	< 220 mW	< 220 mW
Pull-in/drop-out/bounce time typ.	5 ms / 6 ms / 5 ms	5 ms / 6 ms / 5 ms
Nominal operating mode	continuous duty	continuous duty
Dielectric strength contact-coil	4 kV _{eff}	4 kV _{eff}
Surge capacity open contact	1 kV _{eff}	1 kV _{eff}
Mechanical life	5 x 10 ⁶ switching operations	5 x 10 ⁶ switching operations
Mechanical life at max. load (resistance)	5 x 10 ⁴ switching operations	5 x 10 ⁴ switching operations
Ambient operating temperature (V _N)	-25 °C ... +60 °C	-25 °C ... +60 °C
Storage temperature	-40 °C ... +70 °C	-40 °C ... +70 °C
Dimensions (mm) W x H x L	5 x 15 x 28	5 x 15 x 28
Weight	13,5 g	13,5 g

	Sockets for miniature switching relay and optocoupler	
--	---	--

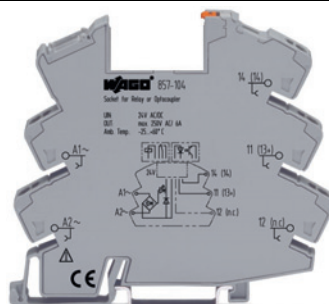
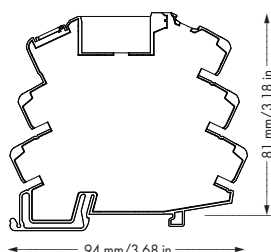

Description	Item No.	Pack. Unit
JUMPFLEX® socket for miniature switching relay and optocoupler, 24 V AC/DC for DIN 35 rail	857-104	1
JUMPFLEX® socket for miniature switching relay and optocoupler, 110 V AC/DC for DIN 35 rail	857-107	1
JUMPFLEX® socket for miniature switching relay and optocoupler, 230 V AC/DC for DIN 35 rail	857-108	1

Technical Data	
Status indication	LED yellow
Operating temperature	-25 °C ... +60 °C
Storage temperature	-40 °C ... +70 °C
Dimensions (mm) W x H x L	6 x 81 x 94
Wire connection	Height from upper-edge of DIN 35 rail CAGE CLAMP®S
Cross sections	solid: 0.08 mm ² ... 2.5 mm ² / AWG 28 ... 12 fine-stranded: 0.34 mm ² ... 2.5 mm ² / AWG 22 ... 12
Stripped lengths	9 ... 10 mm / 0.37 in

Assignment Socket / Replacement Relay / Replacement Optocoupler

	Input Voltage	Item No.	Socket	Replacement Relays or Optocouplers	
Miniature Switching Relays	12 V DC	857-303	857-103	857-150	
	24 V DC	857-304	857-104	857-152	
	48 V DC	857-305	857-105	857-154	
	60 V DC	857-306	857-106	857-155	
	110 V DC	857-307	857-107	857-155	
	220 V DC	857-308	857-108	857-155	
	24 V AC/DC	857-354	857-104	857-152	
	115 V AC/DC	857-357	857-107	857-155	
	230 V AC/DC	857-358	857-108	857-155	
	Miniature Switching Relays (gold contacts)	24 V DC	857-314	857-104	857-153
110 V DC		857-317	857-107	857-157	
220 V DC		857-318	857-108	857-157	
24 V AC/DC		857-364	857-104	857-153	
115 V AC/DC		857-367	857-107	857-157	
230 V AC/DC		857-368	857-108	857-157	
Solid State Relays		24 V DC	857-704	857-104	857-164
		115 V AC/DC	857-707	857-107	857-165
		230 V AC/DC	857-708	857-108	857-165
		24 V DC	857-714	857-104	857-167
	115 V AC/DC	857-717	857-107	857-168	
	230 V AC/DC	857-718	857-108	857-168	
	24 V DC	857-724	857-104	857-161	
	115 V AC/DC	857-727	857-107	857-162	
	230 V AC/DC	857-728	857-108	857-162	

1 JUMPFLEX® 8-Channel Adapter for System Wiring

	8-channel adapter with 14-pin ribbon cable connector Input, positive switching	8-channel adapter with 14-pin ribbon cable connector Output, positive switching
--	---	--

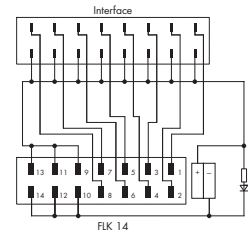
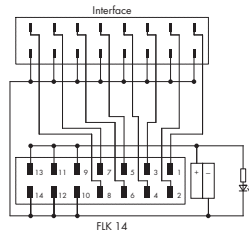
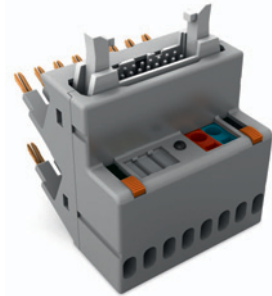
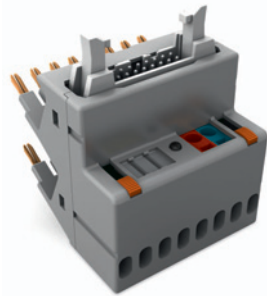
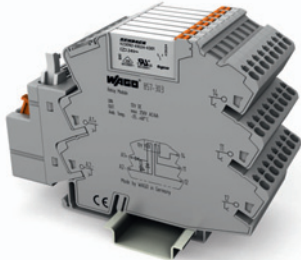

Description	Item No.	Pack. unit	Item No.	Pack. unit
JUMPFLEX® 8-channel adapter for system wiring	857-981	1	857-982	1

Technical Data				
Connection type, signal level	14-pin ribbon cable connector acc. to DIN 41651		14-pin ribbon cable connector acc. to DIN 41651	
Performance level	3		3	
Contact resistance	≤ 20 mΩ		≤ 20 mΩ	
Current carrying capacity	1 A		1 A	
Test voltage	500 V / 50 Hz / 1 min.		500 V / 50 Hz / 1 min.	
Voltage supply V _N	24 V DC		24 V DC	
Supply voltage range	16.8 V ... 31.2 V		16.8 V ... 31.2 V	
Max. total current	3 A		3 A	
Operational indication	LED, green		LED, green	
Connection type, supply	231 Series with CAGE CLAMP®		231 Series with CAGE CLAMP®	
Cross sections	0.08 mm ² ... 2.5 mm ² / AWG 28 ... 14		0.08 mm ² ... 2.5 mm ² / AWG 28 ... 14	
Stripped lengths	5 ... 6 mm / 0.22 in		5 ... 6 mm / 0.22 in	
Accessories	WAGO ribbon cable on request		WAGO ribbon cable on request	

	<p>8-channel adapter with SUB-D male connector Input</p>	
--	---	--

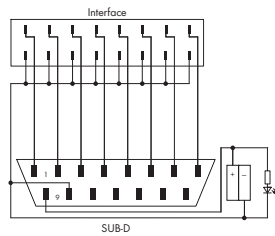
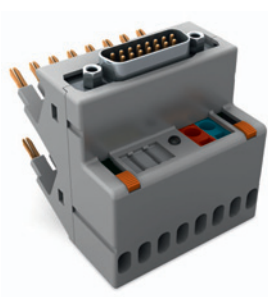
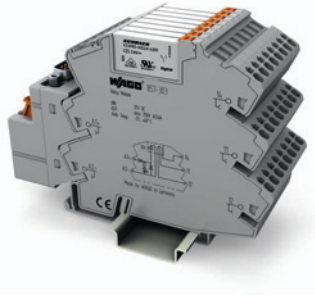

Description	Item No.	Pack. unit
<p>JUMPFLEX® 8-channel adapter for system wiring</p>	<p>857-986</p>	<p>1</p>
<p>Technical Data</p>		
<p>Connection type, signal level</p>	<p>15-pin ribbon cable connector</p>	
<p>Performance level</p>	<p>acc. to DIN 41651</p>	
<p>Contact resistance</p>	<p>2</p>	
<p>Current carrying capacity</p>	<p>≤ 10 mΩ</p>	
<p>Test voltage</p>	<p>1 A</p>	
<p>Voltage supply V_N</p>	<p>500 V / 50 Hz / 1 min.</p>	
<p>Supply voltage range</p>	<p>24 V DC</p>	
<p>Max. total current</p>	<p>16.8 V ... 31.2 V</p>	
<p>Operational indication</p>	<p>3 A</p>	
<p>Operational indication</p>	<p>LED, green</p>	
<p>Connection type, supply</p>	<p>231 Series with CAGE CLAMP®</p>	
<p>Cross sections</p>	<p>0.08 mm² ... 2.5 mm² / AWG 28 ... 14</p>	
<p>Stripped lengths</p>	<p>5 ... 6 mm / 0.22 in</p>	
<p>Accessories</p>	<p>WAGO ribbon cable on request</p>	
<p></p>	<p></p>	
<p></p>	<p></p>	
<p></p>	<p></p>	
<p></p>	<p></p>	
<p></p>	<p></p>	
<p></p>	<p></p>	
<p></p>	<p></p>	
<p></p>	<p></p>	
<p></p>	<p></p>	
<p></p>	<p></p>	

Solid state relay
Input: 230 V AC/DC
Output: 0 V ... 48 V DC / 0.1 A

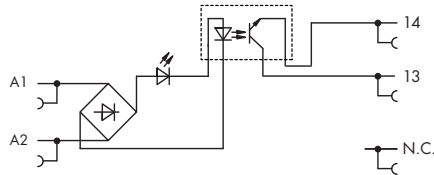
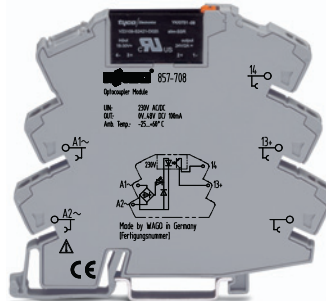
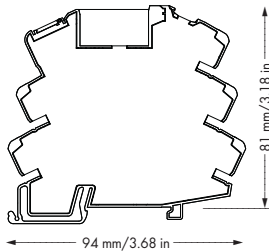

Description	Item No.	Pack. Unit
JUMPFLEX [®] relay socket with solid state relay, for DIN 35 rail	857-708	1
Technical Data Accessories see pages 62 ... 63		
Control circuit:		
Nominal input voltage (V_N)	230 V AC/DC	
Input voltage range	$U_N -15 \% \dots +10 \%$	
Nominal input current (I_N)	3.25 mA	
Load circuit:		
Switching voltage	0 V ... 48 V DC	
Peak reverse voltage	54 V	
Max. switching current	0.1 A DC	
Forward voltage at max. switching current	< 1 V DC	
Ambient operating temperature	-20 °C ... +60 °C	
Storage temperature	-40 °C ... +70 °C	
Dielectric strength control/switching circuit	2.5 kV	
Dimensions (mm) W x H x L	6 x 81 x 94	
Wire connection	Height from upper-edge of DIN 35 rail	
Cross sections	CAGE CLAMP [®] S	
	solid: 0.08 mm ² ... 2.5 mm ² / AWG 28 ... 12	
Stripped lengths	fine-stranded: 0.34 mm ² ... 2.5 mm ² / AWG 22 ... 12	
	9 ... 10 mm / 0.37 in	

	Solid state relay Input: 230 V AC/DC Output: 24 V ... 240 V AC / 1 A	
--	---	--

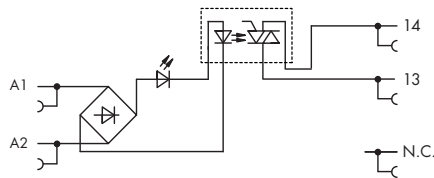
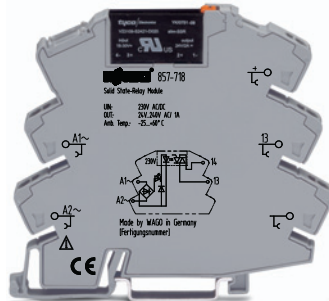
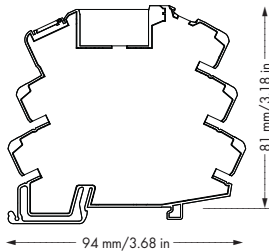

Description	Item No.	Pack. Unit
JUMPFLEX® relay socket with solid state relay, for DIN 35 rail	857-718	1
Technical Data Accessories see pages 62 ... 63		
Control circuit:		
Nominal input voltage (V _N)	230 V AC/DC	
Input voltage range	U _N -15 % ... +10 %	
Nominal input current (I _N)	3.1 mA	
Load circuit:		
Switching voltage	24 V ... 240 V AC	
Peak reverse voltage	600 V	
Max. switching current	1 A AC	
Forward voltage at max. switching current	< 1 V AC	
Ambient operating temperature	-20 °C ... +60 °C	
Storage temperature	-40 °C ... +70 °C	
Dielectric strength control/switching circuit	2.5 kV	
Dimensions (mm) W x H x L	6 x 81 x 94	
Wire connection	Height from upper-edge of DIN 35 rail CAGE CLAMP®S	
Cross sections	solid: 0.08 mm ² ... 2.5 mm ² / AWG 28 ... 12 fine-stranded: 0.34 mm ² ... 2.5 mm ² / AWG 22 ... 12	
Stripped lengths	9 ... 10 mm / 0.37 in	

1 Solid State Relays, 857 Series

62

	Pluggable replacement optocoupler	Pluggable replacement optocoupler
--	-----------------------------------	-----------------------------------

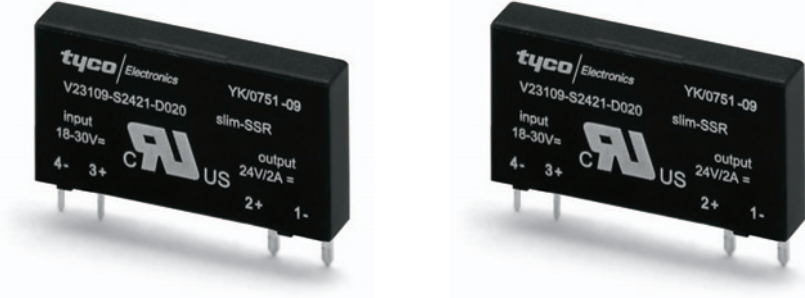

Description	Item No.	Pack. Unit	Item No.	Pack. Unit	Item No.	Pack. Unit
Pluggable optocouplers	857-161	20	857-164	20	857-167	20

Technical Data						
Control circuit:						
Nominal input voltage (V_N)	24 V DC		24 V DC		24 V DC	
Input voltage range	18 V ... 30 V DC		16 V ... 30 V DC		18 V ... 30 V DC	
Nominal input current (I_N)	7 mA		7 mA		7 mA	
Load circuit:						
Switching voltage	0 V ... 24 V DC		0 V ... 48 V DC		24 V ... 240 V AC	
Peak reverse voltage	33 V		54 V		600 V	
Max. switching current	2 A DC		100 mA DC		1 A AC	
Forward voltage at max. switching current	< 120 mV DC		< 1 V DC		< 1 V AC	
Dielectric strength control/switching circuit	2.5 kV		2.5 kV		2.5 kV	
General Specifications						
Ambient operating temperature	-20 °C ... +60 °C		-20 °C ... +60 °C		-20 °C ... +60 °C	
Storage temperature	-40 °C ... +70 °C		-40 °C ... +70 °C		-40 °C ... +70 °C	
Dimensions (mm) W x H x L	5 x 15 x 28		5 x 15 x 28		5 x 15 x 28	

Description	Item No.	Pack. Unit	Item No.	Pack. Unit	Item No.	Pack. Unit
Pluggable optocouplers	857-162	20	857-165	20	857-168	20

Technical Data						
Control circuit:						
Nominal input voltage (V_N)	60 V DC		60 V DC		60 V DC	
Input voltage range	35 V ... 72 V DC		52 V ... 72 V DC		35 V ... 72 V DC	
Nominal input current (I_N)	3 mA		2.8 mA		3.1 mA	
Load circuit:						
Switching voltage	0 V ... 24 V DC		0 V ... 48 V DC		24 V ... 240 V AC	
Peak reverse voltage	33 V		54 V		600 V	
Max. switching current	2 A DC		100 mA DC		1 A AC	
Forward voltage at max. switching current	< 120 mV DC		< 1 V DC		< 1 V AC	
Dielectric strength control/switching circuit	2.5 kV		2.5 kV		2.5 kV	
General Specifications						
Ambient operating temperature	-20 °C ... +60 °C		-20 °C ... +60 °C		-20 °C ... +60 °C	
Storage temperature	-40 °C ... +70 °C		-40 °C ... +70 °C		-40 °C ... +70 °C	
Dimensions (mm) W x H x L	5 x 15 x 28		5 x 15 x 28		5 x 15 x 28	

Accessories, 857 Series

Push-in type jumper bar



Commoning



Description		Item No.	Pack. Unit
Push-in type jumper bars, light gray, insulated, 18 A	2-way	859-402	200 (8x25)
	3-way	859-403	200 (8x25)
	4-way	859-404	200 (8x25)
	5-way	859-405	200 (8x25)
	6-way	859-406	100 (4x25)
	7-way	859-407	100 (4x25)
	8-way	859-408	100 (4x25)
	9-way	859-409	100 (4x25)
	10-way	859-410	100 (4x25)
	Item no. suffix for colored push-in type jumper bars	yellow	... /000-029
red		... /000-005	
blue		... /000-006	

WMB Multi marking system



Marking



Description		Item No.	Pack. Unit
WMB Multi marking system	plain	793-501	5 cards
Marking software and printer/plotter see Section 8			
Marking	1 ... 10 (10x)	793-502	5 cards
	11 ... 20 (10x)	793-503	5 cards
	21 ... 30 (10x)	793-504	5 cards
	31 ... 40 (10x)	793-505	5 cards
	41 ... 50 (10x)	793-506	5 cards
	1 ... 50 (2x)	793-566	5 cards
10 strips with 10 markers, white with black printing			

Operating tool



Wire connection

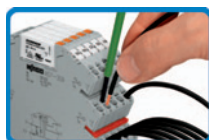

Description		Item No.	Pack. Unit
Operating tool, with partially insulated shaft,	Type 2, blade (3.5 x 0.5) mm	210-720	1

1 Sockets with Miniature Switching Relay

	Relay with 1 changeover contact and status indication (Relay height: 15 mm) Nominal input voltage V_N 12 V, 24 V, 48 V, 60 V, 110 V DC	Relay with 2 changeover contact and status indication (Relay height: 15 mm) Nominal input voltage V_N 12 V, 24 V, 48 V, 60 V, 110 V DC
--	--	--

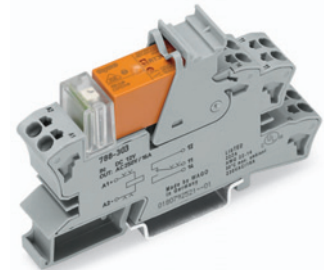
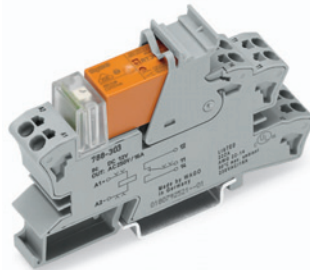
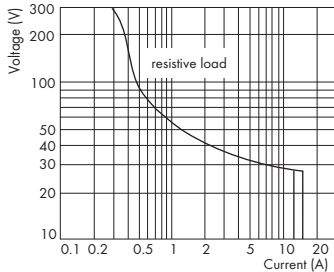

Load limit curve for 788-303 to 788-307, 788-506, 788-507 and 788-508

Note: Inductive loads have to be attenuated by an appropriate protective circuit in order to protect relay coils and contacts.

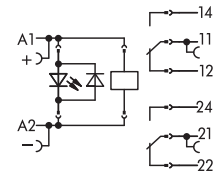
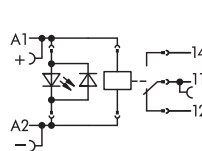

Description	V_N	I_N	Item No.	Pack. unit	V_N	I_N	Item No.	Pack. unit
Relay sockets with pluggable miniature switching relay, for DIN 35 rail	12 V DC	36 mA	788-303	1	12 V DC	36 mA	788-311	1
	24 V DC	19.1 mA	788-304	1	24 V DC	19.1 mA	788-312	1
	48 V DC	11 mA	788-305	1	48 V DC	11 mA	788-313	1
	60 V DC	10.5 mA	788-306	1	60 V DC	10.5 mA	788-314	1
	110 V DC	6 mA	788-307	1	110 V DC	6 mA	788-315	1

Technical Data	Accessories see pages 74 ... 77 + 80 ... 81	
Contact material	AgNi 90/10	AgNi 90/10
Input voltage range	$V_N \pm 10\%$	$V_N \pm 10\%$
Max. switching voltage	250 V AC	250 V AC
Max. continuous current	16 A	2 x 8 A
Max. make current (resistive) at a 10 % duty cycle	4 s 30 A (AC)	4 s 15 A (AC)
Max. Switching power (resistive)	4 kVA AC, DC see load limit curve	2 x 2 kVA AC, DC see load limit curve
Max. switching rate with / without load	6 min ⁻¹ / 1200 min ⁻¹	6 min ⁻¹ / 1200 min ⁻¹
Operating power	400 mW typ.	400 mW typ.
Pull-in/drop-out/bounce time typ.	7 ms / 3 ms / 3 ms	7 ms / 2 ms / 3 ms
Nominal operating mode	continuous duty	continuous duty
Dielectric strength contact-coil	5 kV	5 kV
Dielectric strength open contact	1 kV	1 kV
Nominal voltage acc. to VDE 01 10 Part 1/4.97, IEC 60664-1	250 V / 4 kV / 3	250 V / 4 kV / 3
Mechanical life	30 x 10 ⁶ switching operations	30 x 10 ⁶ switching operations
Degree of protection	IP20	IP20
Ambient operating temperature	-25 °C ... +50 °C	-25 °C ... +50 °C
Storage temperature	-40 °C ... +70 °C	-40 °C ... +70 °C
Dimensions (mm) W x H x L	15 x 54 x 86	15 x 54 x 86
Wire connection	Height from upper-edge of DIN 35 rail CAGE CLAMP®S	Height from upper-edge of DIN 35 rail CAGE CLAMP®S
Cross sections	0.34 mm ² ... 2.5 mm ² / AWG 22 ... 12	0.34 mm ² ... 2.5 mm ² / AWG 22 ... 12
Stripped lengths	9 ... 10 mm / 0.37 in	9 ... 10 mm / 0.37 in
Approvals	DIN VDE 0140 part 1, DIN EN 61 140; DIN VDE 0160, EN 50178; degree of protection II; UL 508	DIN VDE 0140 part 1, DIN EN 61 140; DIN VDE 0160, EN 50178; degree of protection II; UL 508

	<p>Relay with 1 changeover contact and status indication (Relay height: 15 mm) Nominal input voltage V_N 24 V, 115 V, 230 V AC</p>	<p>Relay with 2 changeover contact and status indication (Relay height: 15 mm) Nominal input voltage V_N AC 24 V, 115 V, 230 V</p>
--	--	--

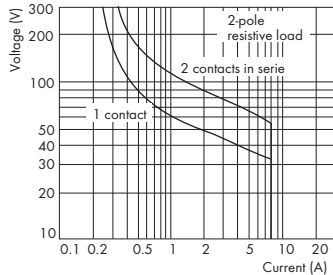

Load limit curve for 788-311 to 788-315, 788-512, 788-515 and 788-516

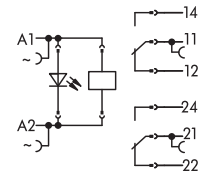
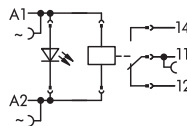

Description	V_N	I_N	Item No.	Pack. unit	V_N	I_N	Item No.	Pack. unit
Relay sockets with pluggable miniature switching relay, for DIN 35 rail	24 V AC	34 mA	788-506	1	24 V AC	34 mA	788-512	1
	115 V AC	8 mA	788-507	1	115 V AC	8 mA	788-515	1
	230 V AC	4.3 mA	788-508	1	230 V AC	3 mA	788-516	1

Technical Data

Accessories see pages 74 ... 77 + 80 ... 81

Accessories see pages 74 ... 77 + 80 ... 81

Contact material	AgNi 90/10	
Input voltage range	$V_N \pm 10\%$	
Max. switching voltage	250 V AC	
Max. continuous current	16 A	
Max. make current (resistive) at a 10 % duty cycle	4 s 30 A (AC)	
Max. Switching power (resistive)	4 kVA AC, DC see load limit curve	
Max. switching rate with / without load	6 min ⁻¹ / 1200 min ⁻¹	
Operating power	0.75 VA	
Pull-in/drop-out/bounce time typ.	7 ms / 3 ms / 3 ms	
Nominal operating mode	continuous duty	
Dielectric strength contact-coil	5 kV	
Dielectric strength open contact	1 kV	
Nominal voltage acc. to VDE 0110 Part 1/4.97, IEC 60664-1	250 V / 4 kV / 3	
Mechanical life	10 x 10 ⁶ switching operations	
Degree of protection	IP20	
Ambient operating temperature	-25 °C ... +50 °C	
Storage temperature	-40 °C ... +70 °C	
Dimensions (mm) W x H x L	15 x 54 x 86	
Wire connection	Height from upper-edge of DIN 35 rail CAGE CLAMP®S	
Cross sections	0.34 mm ² ... 2.5 mm ² / AWG 22 ... 12	
Stripped lengths	9 ... 10 mm / 0.37 in	
Approvals	DIN VDE 0140 part 1, DIN EN 61140; DIN VDE 0160, EN 50178; degree of protection II; Ⓢ; UL 508	

1 Sockets with Miniature Switching Relay

Relay with 1 changeover contact with gold contacts and and status indication (Relay height: 15 mm) Nominal input voltage V_N 24 V DC

Relay with 2 changeover contact with gold contacts and and status indication (Relay height: 15 mm) Nominal input voltage V_N 24 V DC

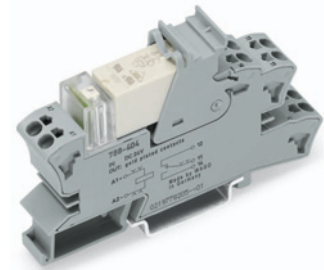
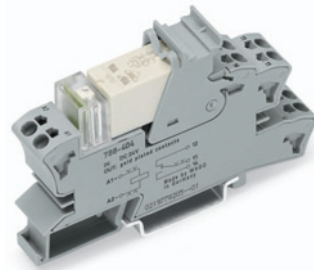
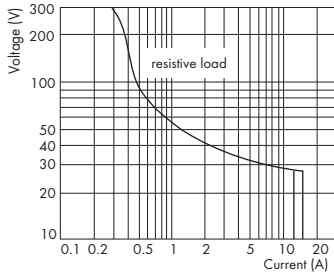

Load limit curve for 788-404, 788-607 and 788-608

* In order to prevent the gold layer from being damaged these values should not be exceeded. Higher switching power leads to evaporation of the gold layer. The resulting deposits in the enclosure may cause sparkovers between the coil and the contact.

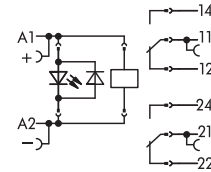
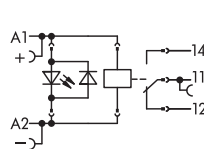

Description	V_N	I_N	Item No.	Pack. unit	V_N	I_N	Item No.	Pack. unit
Relay sockets with pluggable miniature switching relay, for DIN 35 rail	24 V DC	19 mA	788-404	1	24 V DC	19 mA	788-412	1

Technical Data

Accessories see pages 74 ... 77 + 80 ... 81

Accessories see pages 74 ... 77 + 80 ... 81

Contact material	AgNi + 5 μ AU	AgNi + 5 μ AU
Input voltage range	$V_N \pm 10\%$	$V_N \pm 10\%$
Max. switching voltage	250 V AC / 36 V DC*	250 V AC / 36 V DC*
Max. continuous current	50 mA*	2 x 50 mA*
Max. Switching power (resistive)	4 kVA AC, DC see load limit curve	2 x 2 kVA AC, DC see load limit curve
Pull-in/drop-out time typ.	7 ms / 3 ms	7 ms / 3 ms
Nominal operating mode	continuous duty	continuous duty
Dielectric strength contact-coil	5 kV	5 kV
Dielectric strength open contact	1 kV	1 kV
Dielectric strength contact-contact	2.5 kV	2.5 kV
Nominal voltage acc. to VDE 0110 Part 1/4.97, IEC 60664-1	250 V / 4 kV / 3	250 V / 4 kV / 3
Mechanical life	3 x 10 ⁷ switching operations	3 x 10 ⁷ switching operations
Degree of protection	IP20	IP20
Ambient operating temperature	-25 °C ... +50 °C	-25 °C ... +50 °C
Storage temperature	-40 °C ... +70 °C	-40 °C ... +70 °C
Dimensions (mm) W x H x L	15 x 54 x 86	15 x 54 x 86
Wire connection	Height from upper-edge of DIN 35 rail CAGE CLAMP [®] S	Height from upper-edge of DIN 35 rail CAGE CLAMP [®] S
Cross sections	0.34 mm ² ... 2.5 mm ² / AWG 22 ... 12	0.34 mm ² ... 2.5 mm ² / AWG 22 ... 12
Stripped lengths	9 ... 10 mm / 0.37 in	9 ... 10 mm / 0.37 in
Approvals	DIN VDE 0140 part 1, DIN EN 61140; DIN VDE 0160, EN 50178; degree of protection II	DIN VDE 0140 part 1, DIN EN 61140; DIN VDE 0160, EN 50178; degree of protection II

	<p>Relay with 1 changeover contact with gold contacts and and status indication (Relay height: 15 mm) Nominal input voltage V_N 115 V, 230 V AC</p>	<p>Relay with 2 changeover contact with gold contacts and and status indication (Relay height: 15 mm) Nominal input voltage V_N 115 V, 230 V AC</p>
--	---	---

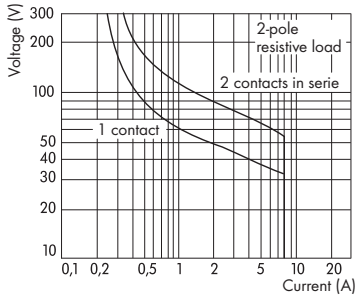

Load limit curve for 788-412, 788-615 and 788-616

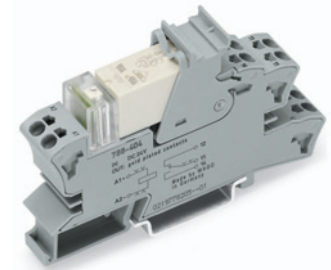
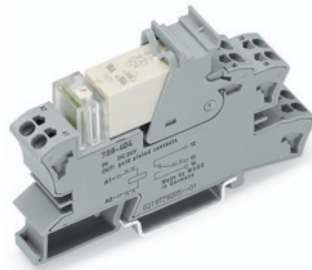

* In order to prevent the gold layer from being damaged these values should not be exceeded. Higher switching power leads to evaporation of the gold layer. The resulting deposits in the enclosure may cause sparkovers between the coil and the contact.

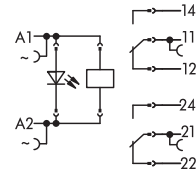
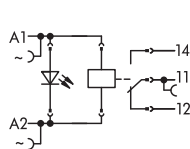

Description	V_N	I_N	Item No.	Pack. unit	V_N	I_N	Item No.	Pack. unit
Relay sockets with pluggable miniature switching relay, for DIN 35 rail	115 V AC	8.2 mA	788-607	1	115 V AC	8.2 mA	788-615	1
	230 V AC	5 mA	788-608	1	230 V AC	5 mA	788-616	1

Technical Data

Accessories see pages 74 ... 77 + 80 ... 81

Accessories see pages 74 ... 77 + 80 ... 81

Contact material	AgNi + 5µ AU	AgNi + 5µ AU
Input voltage range	$V_N \pm 10\%$	$V_N \pm 10\%$
Max. switching voltage	250 V AC / 36 V DC*	250 V AC / 36 V DC*
Max. continuous current	50 mA*	2 x 50 mA*
Max. Switching power (resistive)	4 kVA AC, DC see load limit curve	2 x 2 kVA AC, DC see load limit curve
Pull-in/drop-out time typ.	7 ms / 3 ms	7 ms / 3 ms
Nominal operating mode	continious duty	continious duty
Dielectric strength contact-coil	5 kV	5 kV
Dielectric strength open contact	1 kV	1 kV
Dielectric strength contact-contact	2.5 kV	2.5 kV
Nominal voltage acc. to VDE 0110 Part 1/4.97, IEC 60664-1	250 V / 4 kV / 3	250 V / 4 kV / 3
Mechanical life	3×10^7 switching operations	3×10^7 switching operations
Degree of protection	IP20	IP20
Ambient operating temperature	-25 °C ... +50 °C	-25 °C ... +50 °C
Storage temperature	-40 °C ... +70 °C	-40 °C ... +70 °C
Dimensions (mm) W x H x L	15 x 54 x 86	15 x 54 x 86
Wire connection	CAGE CLAMP®S	CAGE CLAMP®S
Cross sections	0.34 mm² ... 2.5 mm² / AWG 22 ... 12	0.34 mm² ... 2.5 mm² / AWG 22 ... 12
Stripped lengths	9 ... 10 mm / 0.37 in	9 ... 10 mm / 0.37 in
Approvals	DIN VDE 0140 part 1, DIN EN 61140; DIN VDE 0160, EN 50178; degree of protection II; Ⓢ	DIN VDE 0140 part 1, DIN EN 61140; DIN VDE 0160, EN 50178; degree of protection II; Ⓢ

1 Sockets with Miniature Switching Relay

**Relay with 1 changeover contact and status indication
(Relay height: 25 mm)
Nominal input voltage V_N 24 V DC**

**Relay with 2 changeover contact and status indication
(Relay height: 25 mm)
Nominal input voltage V_N 24 V DC**

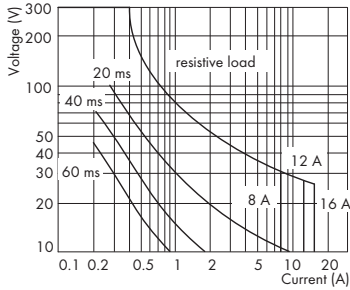

Load limit curve for 788-324 and 788-528

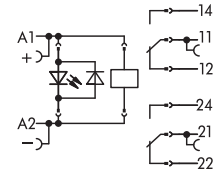
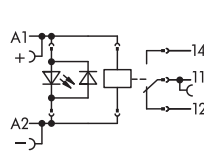
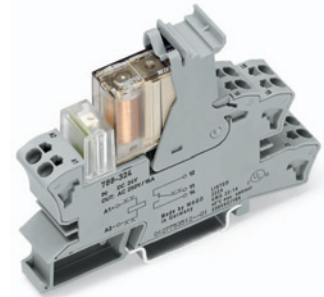
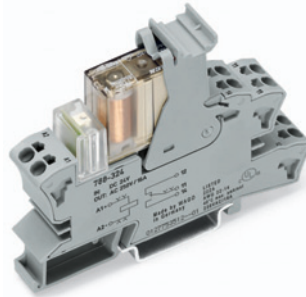

Description	V_N	I_N	Item No.	Pack. unit	V_N	I_N	Item No.	Pack. unit
Relay sockets with pluggable miniature switching relay, for DIN 35 rail	24 V DC	22 mA	788-324	1	24 V DC	22 mA	788-334	1

Technical Data

Accessories see pages 74 ... 77 + 80 ... 81

Accessories see pages 74 ... 77 + 80 ... 81

Contact material	AgCdO	
Input voltage range	$V_N \pm 10\%$	
Max. switching voltage	250 V AC	
Max. continuous current	16 A	
Max. make current (resistive) at a 10 % duty cycle	4 s 25 A (AC)	
Max. Switching power (resistive)	4 kVA AC, DC see load limit curve	
Max. switching rate with / without load	10 min ⁻¹ / 1200 min ⁻¹	
Operating power	500 mW typ.	
Pull-in/drop-out/bounce time typ.	8 ms / 2 ms / 4 ms	
Nominal operating mode	continuous duty	
Dielectric strength contact-coil	4 kV	
Dielectric strength open contact	1 kV	
Nominal voltage acc. to VDE 0110 Part 1/4.97, IEC 60664-1	250 V / 4 kV / 3	
Mechanical life	30 x 10 ⁶ switching operations	
Degree of protection	IP20	
Ambient operating temperature	-25 °C ... +50 °C	
Storage temperature	-40 °C ... +70 °C	
Dimensions (mm) W x H x L	15 x 64 x 86	
Wire connection	Height from upper-edge of DIN 35 rail CAGE CLAMP [®] S	
Cross sections	0.34 mm ² ... 2.5 mm ² / AWG 22 ... 12	
Stripped lengths	9 ... 10 mm / 0.37 in	
Approvals	DIN VDE 0140 part 1, DIN EN 61140; DIN VDE 0160, EN 50178; degree of protection II; UL 508 (max. 40 °C)	

	<p>Relay with 1 changeover contact and status indication (Relay height: 25 mm) Nominal input voltage V_N 230 V AC</p>	<p>Relay with 2 changeover contact and status indication (Relay height: 25 mm) Nominal input voltage V_N 230 V AC</p>
--	---	---

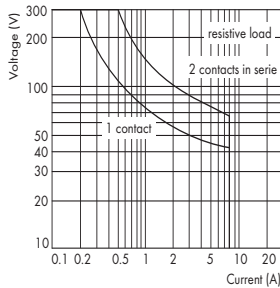

Load limit curve for 788-334 and 788-538

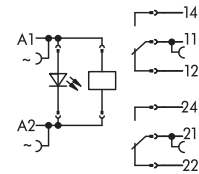
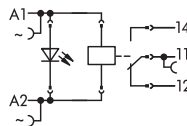
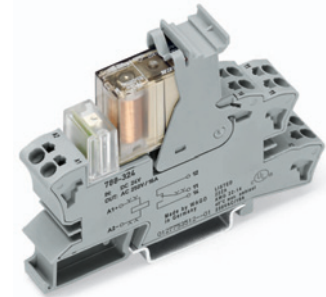
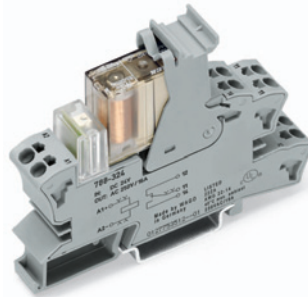

Description	V_N	I_N	Item No.	Pack. unit	V_N	I_N	Item No.	Pack. unit
Relay sockets with pluggable miniature switching relay, for DIN 35 rail	230 V AC	5.6 mA	788-528	1	230 V AC	5.6 mA	788-538	1

Technical Data

Accessories see pages 74 ... 77 + 80 ... 81

Accessories see pages 74 ... 77 + 80 ... 81

Contact material	AgCdO	AgCdO
Input voltage range	$V_N \pm 10\%$	$V_N \pm 10\%$
Max. switching voltage	250 V AC	250 V AC
Max. continuous current	16 A	2 x 8 A
Max. make current (resistive) at a 10 % duty cycle	4 s 14 A (AC)	4 s 14 A (AC)
Max. Switching power (resistive)	4 kVA AC, DC see load limit curve	2 x 2 kVA AC, DC see load limit curve
Max. switching rate with / without load	10 min ⁻¹ / 1200 min ⁻¹	10 min ⁻¹ / 1200 min ⁻¹
Operating power	500 mW typ.	500 mW typ.
Pull-in/drop-out/bounce time typ.	8 ms / 2 ms / 4 ms	9 ms / 3 ms / 3 ms
Nominal operating mode	continuous duty	continuous duty
Dielectric strength contact-coil	4 kV	4 kV
Dielectric strength open contact	1 kV	1 kV
Nominal voltage acc. to VDE 0110 Part 1/4.97, IEC 60664-1	250 V / 4 kV / 3	250 V / 4 kV / 3
Mechanical life	30 x 10 ⁶ switching operations	20 x 10 ⁶ switching operations
Degree of protection	IP20	IP20
Ambient operating temperature	-25 °C ... +50 °C	-25 °C ... +50 °C
Storage temperature	-40 °C ... +70 °C	-40 °C ... +70 °C
Dimensions (mm) W x H x L	15 x 64 x 86	15 x 64 x 86
Wire connection	Height from upper-edge of DIN 35 rail CAGE CLAMP®S	Height from upper-edge of DIN 35 rail CAGE CLAMP®S
Cross sections	0.34 mm ² ... 2.5 mm ² / AWG 22 ... 12	0.34 mm ² ... 2.5 mm ² / AWG 22 ... 12
Stripped lengths	9 ... 10 mm / 0.37 in	9 ... 10 mm / 0.37 in
Approvals	DIN VDE 0140 part 1, DIN EN 61140; DIN VDE 0160, EN 50178; degree of protection II; Ⓢ ; UL 508 (max. 40 °C)	DIN VDE 0140 part 1, DIN EN 61140; DIN VDE 0160, EN 50178; degree of protection II; Ⓢ ; UL 508 (max. 40 °C)

1 Sockets with Miniature Switching Relay

70

Relay with 1 changeover contact and status indication
(Relay height: 15 mm)
Nominal input voltage V_N 24 V DC

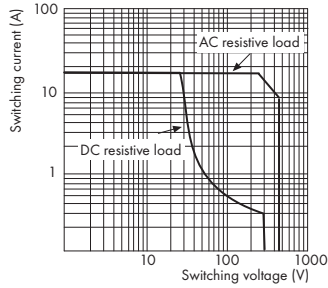

Type of load	Capability	Electrical life
Incandescent lamp	2200 W	20.000
Halogen lamp 230 V AC	1400 W	50.000
Halogen trafo	120 VA	20.000
Fluorescent lamp not comp., CB, cos φ 0,4-0,6	20 x 58 W	25.000
Fluorescent lamp comp., Conv. ballast, C parallel	9 x 58 W	25.000
Fluorescent lamp comp., Conv. ballast, Duo-circuit	600 W	20.000
Fluorescent lamp with electronic ballast	12 x 58 W	25.000
Energy saving lamp 15 W	25 pcs	20.000
Energy saving lamp 13 W	30 pcs	20.000
Energy saving lamp 9 W	38 pcs	20.000
Gas discharge lamp	1000 W	20.000
Dulux-Lamp not compensated	800 W	20.000
Dulux-Lamp compensated	500 W	20.000
Max. capacitance at 230 V AC	60 µF	min. 5.000

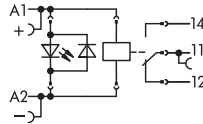

Description	V_N	I_N	Item No.	Pack. unit
Relay sockets with pluggable miniature switching relay, for DIN 35 rail	24 V DC	19 mA	788-354	1

Technical Data

Accessories see pages 74 ... 77 + 80 ... 81

Contact material	Ag alloy
Input voltage range	$U_N - 15\% \dots +20\%$
Max. switching voltage	250 V AC
Max. continuous current	16 A
Max. make current (resistive) at a 10 % duty cycle	(50 ms) 120 A at 230 V AC
Recommended minimum load	> 100 mA / 12 V AC/DC
Max. Switching power (resistive)	4 kVA AC, DC see load limit curve
Operating power	400 mW
Pull-in/drop-out/bounce time typ.	15 ms / 5 ms / -
Nominal operating mode	continuous duty
Dielectric strength contact-coil	5 kV
Dielectric strength open contact	1 kV
Nominal voltage acc. to VDE 01 10 Part 1/4.97, IEC 60664-1	250 V / 4 kV / 3
Mechanical life	10×10^6 switching operations
Mechanical life at max. load (resistance)	min. 100.000 switching operations
Service life at lamp load	see table lamp loads
Degree of protection	IP20
Type of relay	ALZ
Ambient operating temperature	-25 °C ... +50 °C
Storage temperature	-40 °C ... +70 °C
Dimensions (mm) W x H x L	15 x 54 x 86
Wire connection	Height from upper-edge of DIN 35 rail CAGE CLAMP®S
Cross sections	0.34 mm ² ... 2.5 mm ² / AWG 22 ... 12
Stripped lengths	9 ... 10 mm / 0.37 in
Approvals	DIN VDE 0140 part 1, DIN EN 61140; DIN VDE 0160, EN 50178; degree of protection II; UL 508

	Relay with 1 make contact and status indication (Relay height: 25 mm) Nominal input voltage V_N 24 V DC	
--	---	--

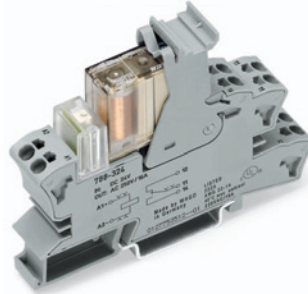
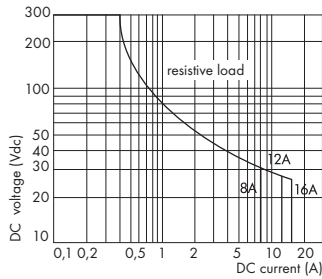

Load	Switching operations
12 A, 250 V AC, $\cos \phi = 1$	3×10^5
TV 8 acc. to UL 508	25×10^3
2500 W, 230 V AC Halogen lamp	$> 10^4$
1000 W, 250 V AC Incandescent lamp	2.3×10^5
3000 W, 250 V AC Incandescent lamp	3.6×10^4
1500 VA, Fluorescent lamp 163 μ F	10^4

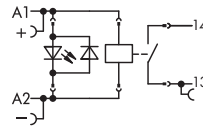

Description	V_N	I_N	Item No.	Pack. unit
Relay sockets with pluggable miniature switching relay, for DIN 35 rail	24 V DC	21.8 mA	788-355	1

Technical Data

Accessories see pages 74 ... 77 + 80 ... 81

Contact material	AgSnO ₂
Input voltage range	$U_N -15 \% \dots +20 \%$
Max. switching voltage	250 V AC
Max. continuous current	16 A
Max. make current (resistive) at a 10 % duty cycle	4 s 25 A (AC)
Peak inrush current	20 ms / 120 A
Recommended minimum load	$> 100 \text{ mA} / 12 \text{ V AC/DC}$
Max. Switching power (resistive)	4 kVA AC, DC see load limit curve
Operating power	500 mW
Pull-in/drop-out/bounce time typ.	8 ms / 2 ms / 2 ms
Nominal operating mode	continuous duty
Dielectric strength contact-coil	4 kV
Dielectric strength open contact	1 kV
Nominal voltage acc. to VDE 0110 Part 1/4.97, IEC 60664-1	250 V / 4 kV / 3
Mechanical life	30×10^6 switching operations
Service life at lamp load	see table lamp loads
Degree of protection	IP20
Type of relay	RP3SL
Ambient operating temperature	-25 °C ... +50 °C
Storage temperature	-40 °C ... +70 °C
Dimensions (mm) W x H x L	15 x 64 x 86
	Height from upper-edge of DIN 35 rail
Wire connection	CAGE CLAMP®S
Cross sections	0.34 mm ² ... 2.5 mm ² / AWG 22 ... 12
Stripped lengths	9 ... 10 mm / 0.37 in
Approvals	DIN VDE 0140 part 1, DIN EN 61140; DIN VDE 0160, EN 50178; degree of protection II; UL 508

1 Sockets with Miniature Switching Relay

72

**Safety relay SR2M (2 changeover contacts)
with forced guided contacts and status
indication
(Relay height: 25 mm)
Nominal input voltage V_N 24 V DC**

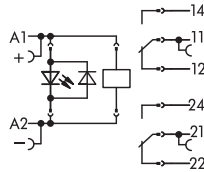
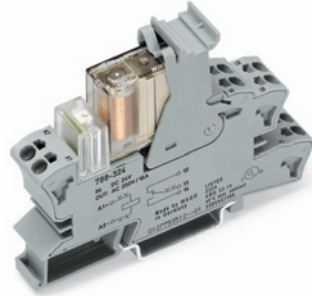
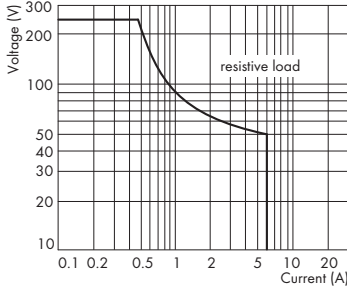

In accordance with EN 50205, it is only permitted to use
1 make contact / 1 break contact for safety circuits
(11-14 and 22-21 or 12-11 and 21-24)

Description	V_N	I_N	Item No.	Pack. unit
Relay sockets with pluggable miniature switching relay, for DIN 35 rail	24 V DC	31 mA	788-384	1

Technical Data

Accessories see pages 74 ... 77 + 80 ... 81

Contact material	AgNi
Input voltage range	$V_N \pm 10\%$
Max. switching voltage	250 V AC
Max. continuous current	6 A
Max. make current (resistive) at a 10 % duty cycle	4 s 14 A (AC)
Recommended minimum load	> 50 mW
Max. Switching power (resistive)	AC 1500 VA; DC see load limit curve
Max. switching rate with / without load	6 min ⁻¹ / 300 min ⁻¹
Operating power	700 mW
Pull-in/drop-out time typ.	10 ms / 4 ms
Nominal operating mode	continuous duty
Dielectric strength contact-coil	4 kV
Dielectric strength open contact	1.5 kV
Dielectric strength contact-contact	3 kV
Clearance and creepage distance contact / coil	8 mm
Adjacent contacts	5.5 mm
Nominal voltage acc. to VDE 0110 Part 1/4.97, IEC 60664-1	250 V / 4 kV / 3
Mechanical life	10 x 10 ⁶ switching operations
Degree of protection	IP20
Ambient operating temperature	-25 °C ... +50 °C
Storage temperature	-40 °C ... +70 °C
Dimensions (mm) W x H x L	15 x 64 x 86
Wire connection	Height from upper-edge of DIN 35 rail CAGE CLAMP®S
Cross sections	0.34 mm ² ... 2.5 mm ² / AWG 22 ... 12
Stripped lengths	9 ... 10 mm / 0.37 in
Approvals	EN 50205; UL 508

	<p>Relay with 1 changeover contact manual operation and status indication (Relay height: 25 mm) Nominal input voltage V_N 24 V DC</p>	<p>Relay with 2 changeover contact manual operation and status indication (Relay height: 25 mm) Nominal input voltage V_N 24 V DC</p>
--	---	---

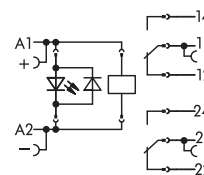
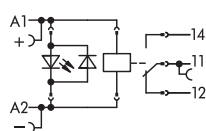
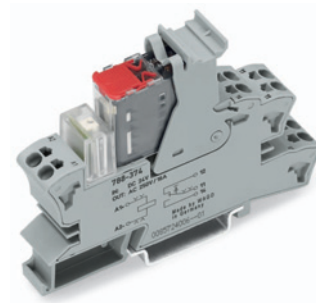
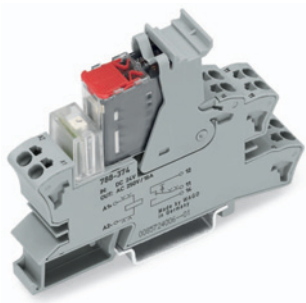

Description	V_N	I_N	Item No.	Pack. unit	V_N	I_N	Item No.	Pack. unit
Relay sockets with pluggable miniature switching relay, for DIN 35 rail	24 V DC	24 mA	788-374	1	24 V DC	24 mA	788-375	1

Technical Data		Accessories see pages 74 ... 77 + 80 ... 81		Accessories see pages 74 ... 77 + 80 ... 81	
Contact material		AgCdO		AgCuNi	
Input voltage range		$V_N \pm 10\%$		$V_N \pm 10\%$	
Max. switching voltage		250 V AC		250 V AC	
Max. continuous current		16 A		8 A	
Max. make current (resistive) at a 10 % duty cycle		20 ms 50 A (AC)		20 ms 30 A (AC)	
Max. Switching power (resistive)		4 kVA AC		2 kVA AC	
Max. switching rate		360 / h		360 / h	
Operating power		500 mW typ.		500 mW typ.	
Pull-in/drop-out/bounce time typ.		8 ms / 3 ms / AK 0.5 ms, RK 5 ms		8 ms / 3 ms / AK 0.5 ms, RK 5 ms	
Nominal operating mode		continuous duty		continuous duty	
Dielectric strength contact-coil		5 kV		5 kV	
Dielectric strength open contact		1 kV		1 kV	
Dielectric strength contact-contact		2.5 kV		2.5 kV	
Nominal voltage acc. to VDE 0110 Part 1/4.97, IEC 60664-1		250 V / 4 kV / 3		250 V / 4 kV / 3	
Mechanical life		50×10^6 switching operations		50×10^6 switching operations	
Degree of protection		IP20		IP20	
Ambient operating temperature		-25 °C ... +50 °C		-25 °C ... +50 °C	
Storage temperature		-40 °C ... +70 °C		-40 °C ... +70 °C	
Dimensions (mm) W x H x L		15 x 64 x 86		15 x 64 x 86	
Wire connection		Height from upper-edge of DIN 35 rail CAGE CLAMP®S		Height from upper-edge of DIN 35 rail CAGE CLAMP®S	
Cross sections		0.34 mm ² ... 2.5 mm ² / AWG 22 ... 12		0.34 mm ² ... 2.5 mm ² / AWG 22 ... 12	
Stripped lengths		9 ... 10 mm / 0.37 in		9 ... 10 mm / 0.37 in	
Approvals		DIN VDE 0140 part 1, DIN EN 61140; DIN VDE 0160, EN 50178; degree of protection II; UL 508		DIN VDE 0140 part 1, DIN EN 61140; DIN VDE 0160, EN 50178; degree of protection II; UL 508	

	Pluggable miniature switching relays (Relay height: 15 mm) 1 changeover contact	Pluggable miniature switching relays (Relay height: 15 mm) 2 changeover contact
--	--	--

Relay height 15 mm

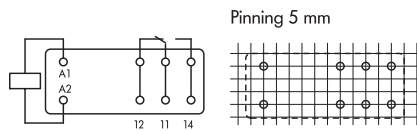
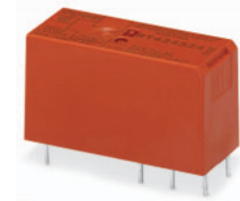
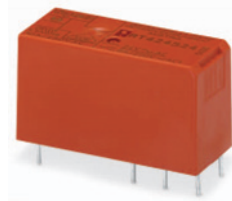
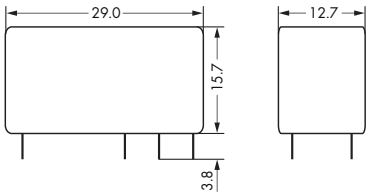

Pinning 5 mm

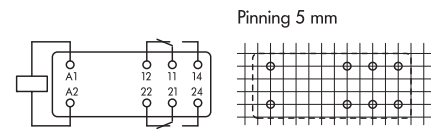

Pinning 5 mm

Description	V _N	Item No.	Pack. unit	V _N	Item No.	Pack. unit
Pluggable miniature switching relays	12 V DC	788-150	20	12 V DC	788-152	20
	24 V DC	788-154	20	24 V DC	788-156	20
	48 V DC	788-158	20	48 V DC	788-160	20
	60 V DC	788-162	20	60 V DC	788-164	20
	110 V DC	788-166	20	110 V DC	788-168	20
	24 V AC	788-170	20	24 V AC	788-172	20
	115 V AC	788-174	20	115 V AC	788-176	20
	230 V AC	788-178	20	230 V AC	788-180	20

Technical Data

Technical Data	1 changeover contact	2 changeover contact
Contact material	AgNi	AgNi
Switching current	16 A	2 x 8 A
Inrush current	30 A	15 A
Max. switching voltage	250 V AC	250 V AC
Switching power	4 kVA	2 kVA
Min. switching current	10 mA	10 mA
Nominal consumption, typ	400 mW	400 mW
Pull-in/drop-out time typ.	7 ms / 3 ms	7 ms / 3 ms
Nominal operating mode	continuous duty	continuous duty
Mechanical life AC coil	> 10 x 10 ⁶ switching operations	> 5 x 10 ⁶ switching operations
Mechanical life DC coil	> 30 x 10 ⁶ switching operations	> 30 x 10 ⁶ switching operations
Dielectric strength contact-coil	5 kV	5 kV
Dielectric strength open contact	1 kV	1 kV
Dielectric strength contact-contact		2.5 kV
Weight	approx. 13.5 g	approx. 13.3 g
Degree of protection	IP40	IP40
Ambient operating temperature AC coil	-40 °C ... +70 °C	-40 °C ... +70 °C
Ambient operating temperature DC coil	-40 °C ... +85 °C	-40 °C ... +85 °C
Flammability acc. to UL 94	V0	V0

	Pluggable miniature switching relays (Relay height: 15 mm) 1 changeover contact (gold contacts)	Pluggable miniature switching relays (Relay height: 15 mm) 2 changeover contact (gold contacts)
--	--	--

Relay height 15 mm

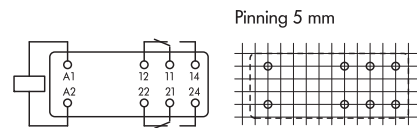
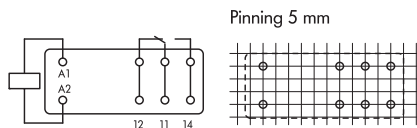
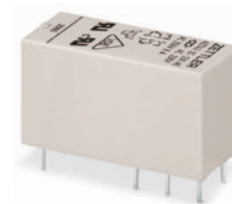
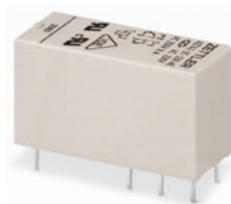
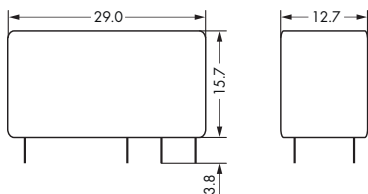

Description	V _N	Item No.	Pack. unit	V _N	Item No.	Pack. unit
Pluggable miniature switching relays	24 V DC	788-155	20	24 V DC	788-157	20
	115 V AC	788-175	20	115 V AC	788-177	20
	230 V AC	788-179	20	230 V AC	788-181	20

Technical Data

Contact material	AgNi + 5 µm Au	AgNi + 5 µm Au
Switching current	50 mA*	2 x 50 mA*
Max. switching voltage	36 V* DC	36 V* DC
Switching power	min. 50 mW	min. 50 mW
Rated power consumption	200 mW DC	200 mW DC
Rated power consumption	0.422 VA AC	0.422 VA AC
Pull-in/drop-out time typ.	7 ms / 3 ms	7 ms / 3 ms
Nominal operating mode	continuous duty	continuous duty
Mechanical life AC coil	> 3 x 10 ⁷ switching operations	> 3 x 10 ⁷ switching operations
Mechanical life DC coil	> 3 x 10 ⁷ switching operations	> 3 x 10 ⁷ switching operations
Dielectric strength contact-coil	5 kV	5 kV
Dielectric strength open contact	1 kV	1 kV
Dielectric strength contact-contact		2.5 kV
Weight	approx. 11 g	approx. 15 g
Degree of protection	IP40	IP40
Ambient operating temperature AC coil	-40 °C ... +70 °C	-40 °C ... +70 °C
Ambient operating temperature DC coil	-40 °C ... +85 °C	-40 °C ... +85 °C
Flammability acc. to UL 94	V0	V0

	Pluggable miniature switching relays (Relay height: 25 mm) 1 changeover contact	Pluggable miniature switching relays (Relay height: 25 mm) 2 changeover contact
--	--	--

Relay height 25 mm

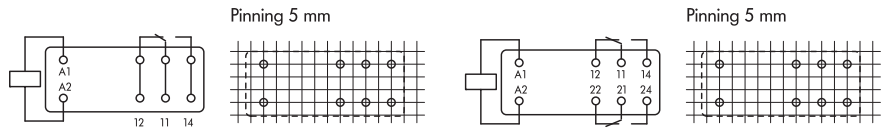
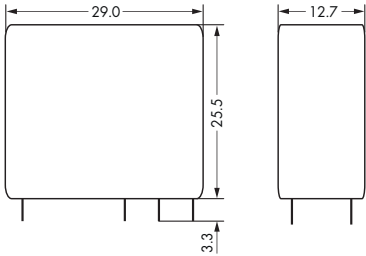

Description	V _N	Item No.	Pack. unit	V _N	Item No.	Pack. unit
Pluggable miniature switching relays	12 V DC	788-182	20	12 V DC	788-183	20
	24 V DC	788-184	20	24 V DC	788-185	20
	48 V DC	788-186	20	48 V DC	788-187	20
	60 V DC	788-188	20	60 V DC	788-189	20
	110 V DC	788-190	20	110 V DC	788-191	20
	230 V AC	788-192	20	230 V AC	788-193	20

Technical Data

	AgNi AgSnO (788-192)	AgNi AgSnO (788-193)
Contact material	AgNi AgSnO (788-192)	AgNi AgSnO (788-193)
Switching current	16 A	2 x 8 A
Max. switching voltage	250 V AC	250 V AC
Switching power	4 kVA	2 kVA
Min. switching current	100 mA	10 mA
Rated power consumption	500 mW DC	500 mW DC
Rated power consumption	1.2 VA AC	1.2 VA AC
Pull-in/drop-out time typ.	9 ms / 3 ms	9 ms / 3 ms
Nominal operating mode	continuous duty	continuous duty
Mechanical life AC coil	> 10 x 10 ⁶ switching operations	> 10 x 10 ⁶ switching operations
Mechanical life DC coil	> 20 x 10 ⁶ switching operations	> 20 x 10 ⁶ switching operations
Dielectric strength contact-coil	5 kV	5 kV
Dielectric strength open contact	1 kV	1 kV
Dielectric strength contact-contact		2.5 kV
Weight	approx. 18 g	approx. 18 g
Degree of protection	IP40	IP40
Ambient operating temperature AC coil	-40 °C ... +70 °C	-40 °C ... +70 °C
Ambient operating temperature DC coil	-40 °C ... +85 °C	-40 °C ... +85 °C
Flammability acc. to UL 94	V0	V0

	Sockets for miniature switching relay 1 changeover contact / 2 changeover contact	
--	--	--

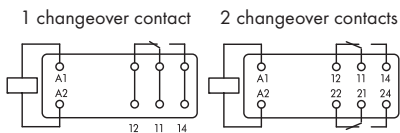

View on pins

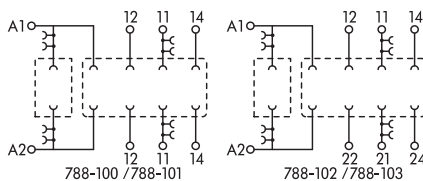
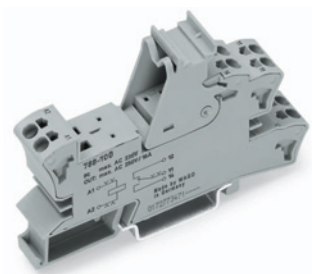
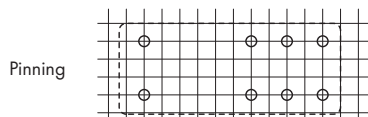

Description	Item No.	Pack. unit
Socket without relay, for DIN 35 rail		
Relay height 15 mm, 1 changeover contact	788-100	1
Relay height 15 mm, 2 changeover contacts	788-102	1
Relay height 25 mm, 1 changeover contact	788-101	1
Relay height 25 mm, 2 changeover contacts	788-103	1

Technical Data

Max. continuous current	16 A / 2 x 8 A
Nominal input voltage (V _N)	depending on relay; max. 250 V AC
Dielectric strength	5 kV (depending on relay)
Max. switching voltage	250 V AC
Max. Switching power (resistive)	4000 VA AC
Nominal operating mode	continuous duty
Nominal voltage acc. to VDE 0110 Part 1/4.97, IEC 60664-1	250 V / 4 kV / 3
Degree of protection	IP20
Ambient operating temperature	-25 °C ... +70 °C (depending on relay)
Storage temperature	-40 °C ... +80 °C
Wire connection	CAGE CLAMP®S
Cross sections	0.34 mm ² ... 2.5 mm ² / AWG 22 ... 12
Stripped lengths	9 ... 10 mm / 0.37 in
Approvals	DIN VDE 0140 part 1, DIN EN 61140; DIN VDE 0160, EN 50178; degree of protection II

	Solid state relay Input: 24 V DC Output: 0 V ... 24 V DC / 3.5 A	Solid state relay Input: 24 V DC Output: 0 V ... 24 V DC / 5 A
--	---	---

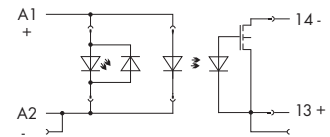
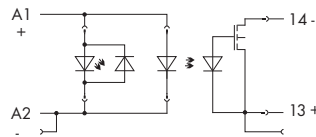
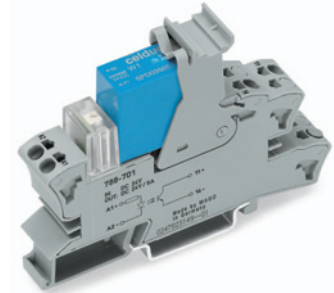
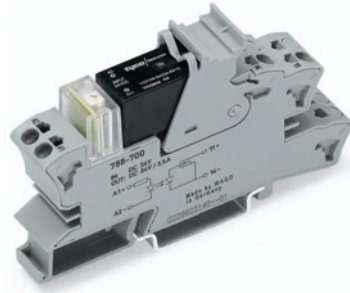

Description	Item No.	Pack. unit	Item No.	Pack. unit
Relay socket with solid state relay, for DIN 35 rail	788-700	1	788-701	1

Technical Data	Accessories see pages 80 ... 81	Accessories see pages 80 ... 81
Control circuit:		
Nominal input voltage (V_N)	24 V DC	24 V DC
Input voltage range	18 V ... 30 V DC	15 V ... 30 V DC
Control current I_N (20 °C)	7 mA \pm 10 %	9.3 mA \pm 10 %
Release voltage	8 V DC	2.5 V DC
Control circuit resistance	3.2 k Ω	2.1 k Ω
Load circuit:		
Load switching voltage range	0 ... 24 V DC	0 ... 30 V DC
Peak reverse voltage	33 V	36 V
Max. switching current	3.5 A DC	DC12/DC13 (5 A DC)
Min. switching current		1 mA DC
Pull-in time		50 μ s
Drop-out time		600 μ s
Switching frequency (max.)		100 Hz at 5 A
Forward voltage at max. switching current	< 0.1 V DC	0.3 V DC
Nominal operating mode	continuous duty	continuous duty
Dielectric strength control/switching circuit	2.5 kV	2.5 kV
Nominal voltage acc. to VDE 0110 Part 1/4.97, IEC 60664-1	250 V / 2.5 kV / 2	250 V / 2.5 kV / 2
Degree of protection	IP 20	IP 20
Ambient operating temperature	-20 °C ... +60 °C	-40 °C ... +60 °C
Storage temperature	-40 °C ... +70 °C	-40 °C ... +70 °C
Dimensions (mm) W x H x L	15 x 53 x 86	15 x 63 x 86
Wire connection	Height from upper-edge of DIN 35 rail CAGE CLAMP [®] S	Height from upper-edge of DIN 35 rail CAGE CLAMP [®] S
Cross sections	0.34 mm ² ... 2.5 mm ² / AWG 22 ... 12	0.34 mm ² ... 2.5 mm ² / AWG 22 ... 12
Stripped lengths	9 ... 10 mm / 0.37 in	9 ... 10 mm / 0.37 in
Approvals	DIN VDE 0140 part 1, DIN EN 61140; DIN VDE 0160, EN 50178; degree of protection II	DIN VDE 0140 part 1, DIN EN 61140; DIN VDE 0160, EN 50178; degree of protection II

	Solid state relay Input: 24 V DC Output: 24 V ... 240 V AC / 1 A	
--	---	--

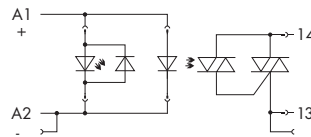
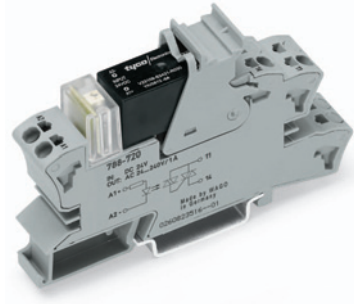

Description	Item No.	Pack. unit
Relay socket with solid state relay, for DIN 35 rail	788-720	1

Technical Data

Accessories see pages 80 ... 81

Control circuit:		
Nominal input voltage (V _N)	24 V DC	
Input voltage range	18 V ... 30 V DC	
Control current U _N (20 °C)	7 mA ±10 %	
Release voltage	4 V DC	
Control circuit resistance	3.2 kΩ	
Load circuit:		
Max. switching voltage	240 V AC	
Load switching voltage range	24 ... 240 V AC	
Peak reverse voltage	600 V	
Max. switching current	1 A AC	
Forward voltage at max. switching current	< 1 V AC	
Nominal operating mode	continuous duty	
Dielectric strength control/switching circuit	3.75 kV	
Nominal voltage acc. to VDE 0110 Part 1/4.97, IEC 60664-1	250 V / 2.5 kV / 2	
Degree of protection	IP 20	
Ambient operating temperature	-20 °C ... +60 °C	
Storage temperature	-40 °C ... +70 °C	
Dimensions (mm) W x H x L	15 x 53 x 86	
Wire connection	Height from upper-edge of DIN 35 rail CAGE CLAMP®S	
Cross sections	0.34 mm ² ... 2.5 mm ² / AWG 22 ... 12	
Stripped lengths	9 ... 10 mm / 0.37 in	
Approvals	DIN VDE 0140 part 1, DIN EN 61140; DIN VDE 0160, EN 50178; degree of protection II	

Status indication



Description	Power consumption at V_N	Item No.	Pack. Unit
Status indication 24 V DC (12 V ... 24 V)	2.4 mA	788-120	50 (2x25)
Status indication 48 V DC (48 V ... 60 V)	1.9 mA	788-121	50 (2x25)
Status indication 110 V DC	1.9 mA	788-122	50 (2x25)
Status indication 24 V AC	2.1 mA	788-123	50 (2x25)
Status indication 115 V AC	1.7 mA	788-124	50 (2x25)
Status indication 230 V AC	1.6 mA	788-125	50 (2x25)

Push-in type jumper bar
788-113

Commoning



Push-in type jumper bar



Description			Item No.	Pack. Unit
Push-in type jumper bar, I max. 18 A	2-way	(module/module)	788-113	200 (8x25)
	3-way		788-114	100 (4x25)
	4-way		788-115	100 (4x25)
	6-way		788-116	100 (4x25)
	8-way		788-117	100 (4x25)
Push-in type jumper bars, light gray, insulated, 18 A	2-way	(intern)	859-402	200 (8x25)

WMB Multi marking system



Marking



Group marker carrier



Description		Item No.	Pack. Unit
WMB Multi marking system	plain	793-501	5 cards
Marking software and printer/plotter see Section 8			
Marking	1 ... 10 (10x)	793-502	5 cards
	11 ... 20 (10x)	793-503	5 cards
	21 ... 30 (10x)	793-504	5 cards
	31 ... 40 (10x)	793-505	5 cards
	41 ... 50 (10x)	793-506	5 cards
10 strips with 10 markers, white with black printing			
Group marker carrier		209-112	50 (1x50)

Operating tool



Wire connection

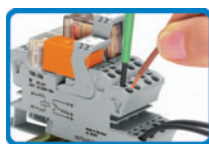

Description		Item No.	Pack. Unit
Operating tool, with partially insulated shaft	Type 2, blade (3.5 x 0.5) mm	210-720	1

Ferrule



Description	Sleeve for mm ² / AWG	Item No.	Pack. Unit
Ferrule, red insulated, 12 mm	2 x 1 mm ² / 2 x 18	216-542	500

1 Sockets with Industrial Relay

	Socket with industrial relay Coil voltage: 24 V DC 4 changeover contacts	Socket with industrial relay Coil voltage: 24 V DC 4 changeover contacts (gold contacts)
--	---	---

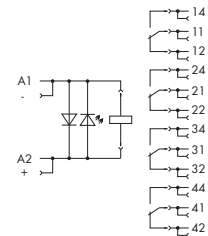
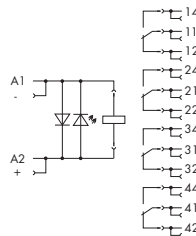

* In order to prevent the gold layer from being damaged, these values shall not be exceeded. Higher switching power leads to evaporation of the gold layer. The resulting deposits in the enclosure may cause sparkovers between the coil and the contact.

Description	Item No.	Pack. Unit	Item No.	Pack. Unit
Relay socket with industrial relay, for DIN 35 rail	858-304	1	858-314	1

Technical Data	Accessories see page 84 ... 86	Accessories see page 84 ... 86
Coil		
Coil voltage	24 V DC	24 V DC
Rated power	0.9 W	0.9 W
Coil current	36.9 mA	36.9 mA
Operating range	0.8 ... 1.1 x V	0.8 ... 1.1 x V
Holding voltage	50 % of V _N	50 % of V _N
Release voltage	0.1 x V	0.1 x V
Contacts		
Contact material	AgCe	AgCe + 5 µm Au
Continuous current	5 A	50 mA*
Inrush current	15 A / 4 s	15 A / 4 s
Max. switching voltage	250 V AC / 30 V DC	30 V DC*
Switching power (max.) AC1 / AC15	1250 VA / 300 VA	1250 VA / 300 VA
1-phase motor load AC3	0.12 kW	0.12 kW
Switching current (max.) DC1	5 A at 30 V DC	5 A at 30 V DC
Min. switching load	12 V / 100 mA	12 V / 100 mA
Switching frequency under load	20 cycles/min.	20 cycles/min.
General Specifications		
Mechanical life	20 x 10 ⁶ switching operations	20 x 10 ⁶ switching operations
Electrical life	1 x 10 ⁵ switching operations	1 x 10 ⁵ switching operations
Pull-in/drop-out/bounce time typ.	25 ms / 25 ms / 4 ms	25 ms / 25 ms / 4 ms
Nominal voltage acc. to VDE 01 10 Part 1/4.97, IEC 60664-1	250 V / 2.5 kV / 2	250 V / 2.5 kV / 2
Dielectric strength contact-coil (1.2/50 µs)	4 kV	4 kV
Dielectric strength contact-coil (AC, 1 min)	1.5 kV	1.5 kV
Dielectric strength open contact	1 kV	1 kV
Dielectric strength contact-contact	1.5 kV	1.5 kV
Ambient operating temperature	-25 °C ... +70 °C (V _L + 50 °C)	-25 °C ... +70 °C (V _L + 50 °C)
Storage temperature	-40 °C ... +80 °C	-40 °C ... +80 °C
Dimensions (mm) W x H x L	31 x 73 x 97	31 x 73 x 97
	Height from upper-edge of DIN 35 rail	Height from upper-edge of DIN 35 rail
Wire connection	CAGE CLAMP®S	CAGE CLAMP®S
Cross sections	2 x 0.34 mm ² ... 2 x 1.5 mm ² / 1 x 2.5 mm ² / AWG 22 ... 16	2 x 0.34 mm ² ... 2 x 1.5 mm ² / 1 x 2.5 mm ² / AWG 22 ... 16
Stripped lengths	9 ... 10 mm / 0.37 in	9 ... 10 mm / 0.37 in

	Socket with industrial relay Coil voltage: 230 V AC 4 changeover contacts	Socket with industrial relay Coil voltage: 230 V AC 4 changeover contacts (gold contacts)
--	--	--

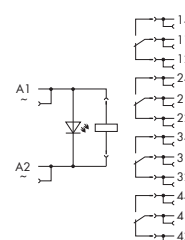
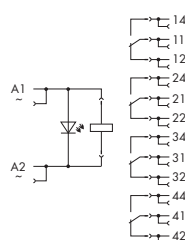

* In order to prevent the gold layer from being damaged, these values shall not be exceeded. Higher switching power leads to evaporation of the gold layer. The resulting deposits in the enclosure may cause sparkovers between the coil and the contact.

Description	Item No.	Pack. Unit	Item No.	Pack. Unit
Relay socket with industrial relay, for DIN 35 rail	858-508	1	858-518	1

Technical Data		Accessories see page 84 ... 86	Accessories see page 84 ... 86
Coil			
Coil voltage	230 V AC		230 V AC
Rated power	1.2 VA		1.2 VA
Coil current	8.3 mA		8.3 mA
Operating range	0.8 ... 1.1 x V		0.8 ... 1.1 x V
Holding voltage	80 % of V _N		80 % of V _N
Release voltage	0.3 x V		0.3 x V
Contacts			
Contact material	AgCe		AgCe + 5 µm Au
Continuous current	5 A		50 mA*
Inrush current	15 A / 4 s		15 A / 4 s
Max. switching voltage	250 V AC / 30 V DC		30 V DC*
Switching power (max.) AC1 / AC15	1250 VA / 300 VA		1250 VA / 300 VA
1-phase motor load AC3	0.12 kW		0.12 kW
Switching current (max.) DC1	5 A at 30 V DC		5 A at 30 V DC
Min. switching load	12 V / 100 mA		12 V / 100 mA
Switching frequency under load	20 cycles/min.		20 cycles/min.
General Specifications			
Mechanical life	20 x 10 ⁶ switching operations		20 x 10 ⁶ switching operations
Electrical life	1 x 10 ⁵ switching operations		1 x 10 ⁵ switching operations
Pull-in/drop-out/bounce time typ.	25 ms / 25 ms / 4 ms		25 ms / 25 ms / 4 ms
Nominal voltage acc. to VDE 01 10 Part 1/4.97, IEC 60664-1	250 V / 2.5 kV / 2		250 V / 2.5 kV / 2
Dielectric strength contact-coil (1.2/50 µs)	4 kV		4 kV
Dielectric strength contact-coil (AC, 1 min)	1.5 kV		1.5 kV
Dielectric strength open contact	1 kV		1 kV
Dielectric strength contact-contact	1.5 kV		1.5 kV
Ambient operating temperature	-25 °C ... +70 °C (V _I + 50 °C)		-25 °C ... +70 °C (V _I + 50 °C)
Storage temperature	-40 °C ... +80 °C		-40 °C ... +80 °C
Dimensions (mm) W x H x L	31 x 73 x 97		31 x 73 x 97
Wire connection	Height from upper-edge of DIN 35 rail CAGE CLAMP®S		Height from upper-edge of DIN 35 rail CAGE CLAMP®S
Cross sections	2 x 0.34 mm ² ... 2 x 1.5 mm ² / 1 x 2.5 mm ² / AWG 22 ... 16		2 x 0.34 mm ² ... 2 x 1.5 mm ² / 1 x 2.5 mm ² / AWG 22 ... 16
Stripped lengths	9 ... 10 mm / 0.37 in		9 ... 10 mm / 0.37 in

	Pluggable industrial relays, 4 changeover contacts with integrated LED and recovery diode and manual operation	Pluggable industrial relays, 4 changeover contacts with integrated LED and manual operation
--	--	---

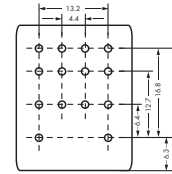
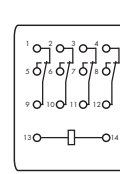
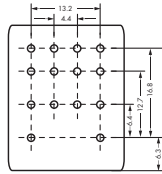
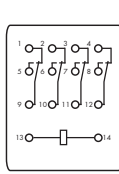
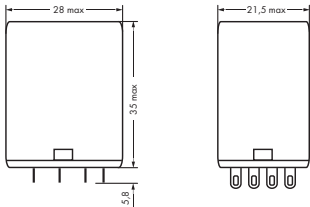

* In order to prevent the gold layer from being damaged these values should not be exceeded. Higher switching power leads to evaporation of the gold layer. The resulting deposits in the enclosure may cause sparkover between the coil and the contact.

Description	V _N	Item No.	Pack. unit	V _N	Item No.	Pack. unit
Pluggable industrial relay	24 V DC	858-150	1	240 V AC	858-151	1
	24 V DC*	858-152	1	240 V AC*	858-153	1

Technical Data

Coil		
Coil voltage	24 V DC	240 V AC
Rated power	0,9 W	1,2 VA
Coil current	36,9 mA	8,3 mA
Operating range	0,8 ... 1,1 x V	0,8 ... 1,1 x V
Holding voltage	50 % of V _N	80 % of V _N
Release voltage	0,1 x V	0,3 x V
Contacts		
Contact material	AgCe, AgCe + 5 μm Au*AgCe, AgCe + 5 μm Au*	AgCe, AgCe + 5 μm Au*
Continuous current	5 A *	5 A *
Inrush current	15 A / 4 s	15 A / 4 s
Max. switching voltage	250 V AC / 30 V DC	250 V AC / 30 V DC
Switching power (max.) AC1 / AC15	1250 VA / 300 VA	1250 VA / 300 VA
1-phase motor load AC3	0,12 kW	0,12 kW
Switching current (max.) DC1	5 A at 30 V DC	5 A at 30 V DC
Min. switching load	12 V / 100 mA	12 V / 100 mA
Switching frequency under load	20 cycles/min.	20 cycles/min.
General Specifications		
Mechanical life	20 x 10 ⁶ switching operations	20 x 10 ⁶ switching operations
Electrical life	1 x 10 ⁵ switching operations	1 x 10 ⁵ switching operations
Pull-in/drop-out/bounce time typ.	25 ms / 25 ms / 4 ms	25 ms / 25 ms / 4 ms
Nominal voltage acc. to VDE 01 10 Part 1/4.97, IEC 60664-1	250 V / 2 kV / 2	250 V / 2 kV / 2
Dielectric strength contact-coil (1,2/50 μs)	4 kV	4 kV
Dielectric strength contact-coil (AC, 1 min)	1,5 kV	1,5 kV
Dielectric strength open contact	1 kV	1 kV
Dielectric strength contact-contact	1,5 kV	1,5 kV
Ambient operating temperature	-25 °C ... +70 °C	-25 °C ... +70 °C
Mounting distance in a row	6 mm	6 mm
Weight	approx. 37 g	approx. 37 g

Sockets with Industrial Relay

	Socket for industrial relays 2 and 4 changeover contacts	
--	--	--

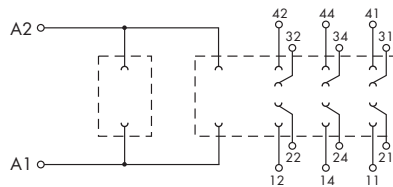

Note: Inductive loads have to be attenuated by an appropriate protective circuit in order to protect relay coils and contacts.

Description	Item No.	Pack. Unit
Relay socket for industrial relays, for DIN 35 rail	858-100	1

Technical Data

Nominal input voltage (V _N)	depending on Relay; max. 250 V AC
Max. switching voltage	250 V AC
Max. continuous current	4 x 8 A (4 changeover contacts); 2 x 12 A (2 changeover contacts)
Max. Switching power (resistive)	4000 VA AC
Nominal operating mode	continuous duty
Dielectric strength	4 kV (depending on relay)
Nominal voltage acc. to VDE 0110 Part 1/4.97, IEC 60664-1	250 V / 4 kV / 3
Degree of protection	IP 20
Ambient operating temperature	-25 °C ... +70 °C (depending on relay)
Storage temperature	-40 °C ... +80 °C
Dimensions (mm) W x H x L	31 x 39 x 97 Height from upper-edge of DIN 35 rail
Wire connection	CAGE CLAMP®S
Stripped lengths	9 ... 10 mm / 0.37 in
Cross sections	2 x 0.34 mm ² ... 2 x 1.5 mm ² / 1 x 2.5 mm ² / AWG 22 ... 16
Approvals	IEC60664 / IEC60664A / DIN VDE0110 Degree of pollution 2 Overvoltage category 2

Holding bracket



Description	Item No.	Pack. unit
Holding bracket for industrial relays (height 33.5 mm ... 35.5 mm)	858-110	1

Push-in type jumper bar



Description	Item No.	Pack. unit
Push-in type jumper bar	858-402	200

Status indication



Description	Power consumption at V_N	Item No.	Pack. Unit
Status indication 24 V DC (12 V ... 24 V)	2.4 mA	788-120	50 (2x25)
Status indication 48 V DC (48 V ... 60 V)	1.9 mA	788-121	50 (2x25)
Status indication 110 V DC	1.9 mA	788-122	50 (2x25)
Status indication 24 V AC	2.1 mA	788-123	50 (2x25)
Status indication 115 V AC	1.7 mA	788-124	50 (2x25)
Status indication 230 V AC	1.6 mA	788-125	50 (2x25)

NOTE:

Only required when using relays without integrated operating indicator!

Operating tool



Description	Item No.	Pack. unit
Operating tool, with partially insulated shaft Type 2, blade (3.5 x 0.5) mm	210-720	1

	Relay with 1 make contact Relay direct soldered with universal mounting carrier	Relay with 1 break contact Relay direct soldered with universal mounting carrier
--	---	--

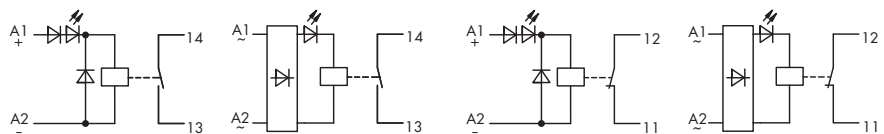

Description	V_N	I_N	Item No.	Pack. Unit	V_N	I_N	Item No.	Pack. Unit
Switching relay module	24 V DC	16 mA	288-364	1	24 V DC	16 mA	288-368	1
	24 V AC/DC	16 mA	288-564	1	24 V AC/DC	16 mA	288-568	1
	48 V AC/DC	9.1 mA	288-565	1				
	115 V AC/DC	4.4 mA	288-567	1				

Technical Data

Contact material	AgNi 0.15 + HV	AgNi 0.15 + HV
Max. switching voltage	250 V DC / 250 V AC	250 V DC / 250 V AC
Max. make / break current	4 s 16 A / 8 A	4 s 16 A / 8 A
Max. continuous current	5 A	5 A
Max. switching power (resistive)	100 W / 1500 VA	100 W / 1500 VA
Pull-in / operating power	240 mW / 500 mW	240 mW / 500 mW
Pull-in/drop-out/bounce time typ.	4 ms / 6 ms / 2 ms	4 ms / 6 ms / 2 ms
Dielectric strength contact-coil (AC, 1 min)	4 kV	4 kV
Nominal voltage acc. to VDE 0110 Part 1/4.97, IEC 60664-1	250 V / 4 kV / 3	250 V / 4 kV / 3
Mechanical life	30 x 10 ⁶ switching operations	30 x 10 ⁶ switching operations
Mechanical life at max. load (resistance)	2 x 10 ⁵ switching operations	2 x 10 ⁵ switching operations
Ambient operating temperature	-25 °C ... +40 °C	-25 °C ... +40 °C
Dimensions (mm) L x W x H incl. mounting carrier and relay	13 x 47 x 85	13 x 47 x 85
Wire connection	Height from upper-edge of DIN 35 rail CAGE CLAMP® (WAGO 236 Series)	Height from upper-edge of DIN 35 rail CAGE CLAMP® (WAGO 236 Series)
Cross sections	0.08 mm ² ... 2.5 mm ² / AWG 28 ... 12	0.08 mm ² ... 2.5 mm ² / AWG 28 ... 12
Stripped lengths	5 ... 6 mm / 0.22 in	5 ... 6 mm / 0.22 in
Accessories		
WMB Multi marking system for mounting carrier	see page 323	see page 323
Marker strips for mounting carrier	white 709-198 / transparent 709-197	white 709-198 / transparent 709-197

	Relay with 1 changeover contact Relay direct soldered with connectors	Relay with 1 changeover contact Relay direct soldered with universal mounting carrier
--	---	---

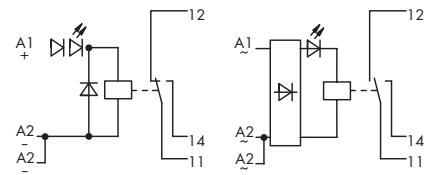
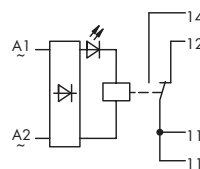

Description	V _N	I _N	Item No.	Pack. Unit	V _N	I _N	Item No.	Pack. Unit
Switching relay module	24 V AC/DC	16 mA	288-554	1	24 V DC	21.8 mA	288-304	1
					24 V AC/DC	21.8 mA	288-504	1
					230 V AC	6.1 mA	288-508	1

Technical Data

Contact material	AgNi 0.15 + HV	AgNi 0.15 + HV
Max. switching voltage	250 V DC / 250 V AC	300 V DC / 250 V AC
Max. make / break current	4 s 16 A / 8 A	4 s 20 A / 8 A
Max. continuous current	5 A	6 A
Max. switching power (resistive)	100 W / 1500 VA	192 W / 1750 VA
Pull-in / operating power	240 mW / 500 mW	261 mW / 533 mW
Pull-in/drop-out/bounce time typ.	4 ms / 6 ms / 2 ms	9 ms / 3 ms / 2 ms
Dielectric strength contact-coil (AC, 1 min)	4 kV	4 kV
Nominal voltage acc. to VDE 0110 Part 1/4.97, IEC 60664-1	250 V / 4 kV / 3	250 V / 4 kV / 3
Mechanical life	30 x 10 ⁶ switching operations	30 x 10 ⁶ switching operations
Mechanical life at max. load (resistance)	2 x 10 ⁵ switching operations	1 x 10 ⁵ switching operations
Ambient operating temperature	-25 °C ... +40 °C	-25 °C ... +40 °C
Dimensions (mm) L x W x H incl. mounting carrier and relay	13 x 52 x 85	20.5 x 48 x 85
Wire connection	Height from upper-edge of DIN 35 rail CAGE CLAMP® (WAGO 231 Series)	Height from upper-edge of DIN 35 rail CAGE CLAMP® (WAGO 236 Series)
Cross sections	0.08 mm ² ... 2.5 mm ² / AWG 28 ... 12	0.08 mm ² ... 2.5 mm ² / AWG 28 ... 12
Stripped lengths	8 ... 9 mm / 0.33 in	5 ... 6 mm / 0.22 in
Accessories		
WMB Multi marking system for mounting carrier	see page 323	see page 323
Marker strips for mounting carrier	white 709-198 / transparent 709-197	white 709-198 / transparent 709-197

	Relay with 2 changeover contacts Relay direct soldered with universal mounting carrier	with 2 relays, 1 changeover contact each Relay direct soldered with universal mounting carrier
--	--	--

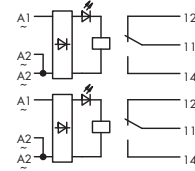
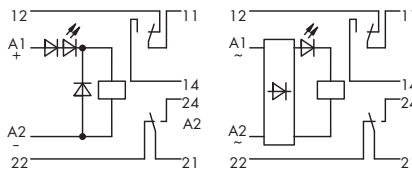
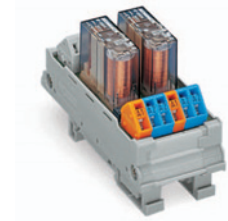

Description	V _N	I _N	Item No.	Pack. Unit	V _N	I _N	Item No.	Pack. Unit
Switching relay module	24 V DC	21.8 mA	288-312	1	24 V AC/DC	21.8 mA	288-758	1
	24 V AC/DC	21.8 mA	288-512	1	115 V AC/DC	4.8 mA	288-761	1
					230 V AC	4.1 mA	288-762	1

Technical Data

Contact material	AgNi 0.15 + HV	AgNi 0.15 + HV
Max. switching voltage	250 V DC / 250 V AC	300 V DC / 250 V AC
Max. make / break current	4 s 14 A / 8 A	20 A / 8 A
Max. continuous current	6 A	6 A
Max. switching power (resistive)	100 W / 1500 VA	192 W / 1500 VA
Pull-in / operating power	261 mW / 533 mW	261 mW / 533 mW
Pull-in/drop-out/bounce time typ.	8 ms / 3 ms / 2 ms	9 ms / 3 ms / 2 ms
Dielectric strength contact-coil (AC, 1 min)	2.5 kV	4 kV
Nominal voltage acc. to VDE 0110 Part 1/4.97, IEC 60664-1	250 V / 2.5 kV / 3	250 V / 4 kV / 3
Mechanical life	30 x 10 ⁶ switching operations	30 x 10 ⁶ switching operations
Mechanical life at max. load (resistance)	1 x 10 ⁵ switching operations	1 x 10 ⁵ switching operations
Ambient operating temperature	-25 °C ... +40 °C	-25 °C ... +40 °C
Dimensions (mm) L x W x H incl. mounting carrier and relay	22.5 x 48 x 85	38.5 x 48 x 85
Wire connection	Height from upper-edge of DIN 35 rail CAGE CLAMP® (WAGO 236 Series)	Height from upper-edge of DIN 35 rail CAGE CLAMP® (WAGO 236 Series)
Cross sections	0.08 mm ² ... 2.5 mm ² / AWG 28 ... 12	0.08 mm ² ... 2.5 mm ² / AWG 28 ... 12
Stripped lengths	5 ... 6 mm / 0.22 in	5 ... 6 mm / 0.22 in
Accessories		
WMB Multi marking system for mounting carrier	see page 323	see page 323
Marker strips for mounting carrier	white 709-198 / transparent 709-197	white 709-198 / transparent 709-197

with 8 relays, 1 changeover contact each
Relay direct soldered with universal mounting
carrier

with 8 relays, 1 changeover contact each
Relay in socket with universal mounting
carrier

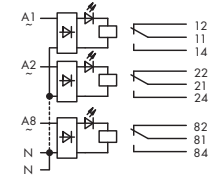
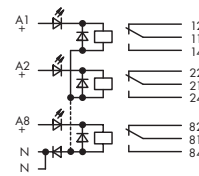
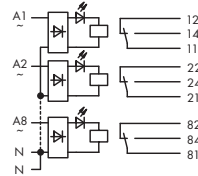
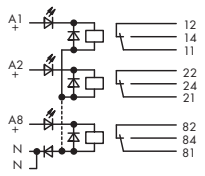

Description	V_N	I_N	Item No.	Pack. Unit	V_N	I_N	Item No.	Pack. Unit
Switching relay module	24 V DC	10.2 mA	287-804	1	24 V DC	21.8 mA	287-824	1
	24 V AC/DC	10.2 mA	287-814	1	24 V AC/DC	21.8 mA	287-834	1

Technical Data

Contact material	AgNi 0.15 + HV	AgNi 0.15 + HV
Max. switching voltage	250 V DC / 250 V AC	300 V DC / 250 V AC
Max. make / break current	4 s 30 A / 8 A	20 A / 8 A
Max. continuous current	6 A	6 A
Max. switching power (resistive)	90 W / 1500 VA	192 W / 1500 VA
Pull-in / operating power	170 mW / 245 mW	261 mW / 533 mW
Pull-in/drop-out/bounce time typ.	7 ms / 3 ms / 2 ms	9 ms / 3 ms / 2 ms
Dielectric strength contact-coil (AC, 1 min)	4 kV	4 kV
Nominal voltage acc. to VDE 0110 Part 1/4.97, IEC 60664-1	250 V / 2.5 kV / 3	250 V / 2.5 kV / 3
Mechanical life	20 x 10 ⁶ switching operations	20 x 10 ⁶ switching operations
Mechanical life at max. load (resistance)	2 x 10 ⁵ switching operations	2 x 10 ⁵ switching operations
Ambient operating temperature	-25 °C ... +40 °C	-25 °C ... +40 °C
Dimensions (mm) L x W x H incl. mounting carrier and relay	127 x 38 x 85	127 x 58 x 85
Wire connection	Height from upper-edge of DIN 35 rail CAGE CLAMP® (WAGO 236 Series)	Height from upper-edge of DIN 35 rail CAGE CLAMP® (WAGO 236 Series)
Cross sections	0.08 mm ² ... 2.5 mm ² / AWG 28 ... 12	0.08 mm ² ... 2.5 mm ² / AWG 28 ... 12
Stripped lengths	5 ... 6 mm / 0.22 in	5 ... 6 mm / 0.22 in
Accessories		
WMB Multi marking system for mounting carrier	see page 323	see page 323
Marker strips for mounting carrier	white 709-198 / transparent 709-197	white 709-198 / transparent 709-197

	<p>with 16 relays, 1 changeover contact each Relay in socket with universal mounting carrier</p>	
--	---	--

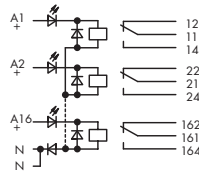
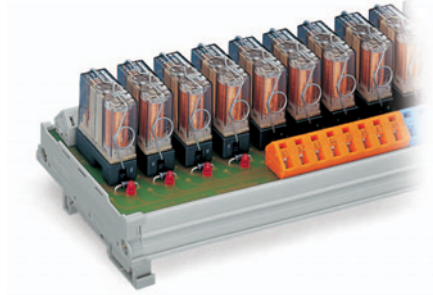
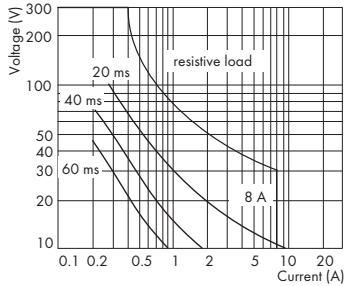

Description	V _N	I _N	Item No.	Pack. Unit
Switching relay module	12 V DC	43.8 mA	287-853	1
	24 V DC	21.8 mA	287-854	1

Technical Data

Input voltage range	V _N -15 % ... +20 %
Contact material	AgNi 0.15
Max. switching voltage	250 V DC / 250 V AC
Max. make / break current	4 s 16 A (AC) / 5 A (24 V DC)
Max. continuous current	6 A
Max. switching power (resistive)	1500 VA AC; DC see load limit curve
Recommended minimum load	100 mA / 10 V AC/DC (1 W, 1 VA)
Pull-in / operating power	533 mW
Pull-in/drop-out/bounce time typ.	10 ms / 4 ms / 2 ms
Nominal operating mode	continuous duty
Dielectric strength contact-coil (AC, 1 min)	4 kV
Nominal voltage acc. to VDE 0110 Part 1/4.97, IEC 60664-1	250 V / 2.5 kV / 3
Mechanical life	30 x 10 ⁶ switching operations
Mechanical life at max. load (resistance)	1 x 10 ⁵ switching operations
Ambient operating temperature	-25 °C ... +40 °C
Storage temperature	-40 °C ... +70 °C
Dimensions (mm) L x W x H	287 x 58 x 85
incl. mounting carrier and relay	
Wire connection	Height from upper-edge of DIN 35 rail CAGE CLAMP® (WAGO 236 Series)
Cross sections	0.08 mm ² ... 2.5 mm ² / AWG 28 ... 12
Stripped lengths	5 ... 6 mm / 0.22 in
Approvals	DIN VDE 0140, DIN VDE 0160 and IEC 60255, DIN VDE 0435 (corresponding parts)
Accessories	
WMB Multi marking system for mounting carrier	see page 323
Marker strips for mounting carrier	white 709-198 / transparent 709-197

1 Rail Mounted Relay Modules

	Relay with 1 make contact Relay direct soldered with universal mounting carrier Designed for switching high inrush current loads i.e. filament lamp loads	with 4 relays, 1 make contact each Relay direct soldered with universal mounting carrier Designed for switching high inrush current loads i.e. filament lamp loads
--	---	--

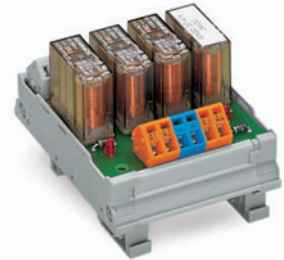
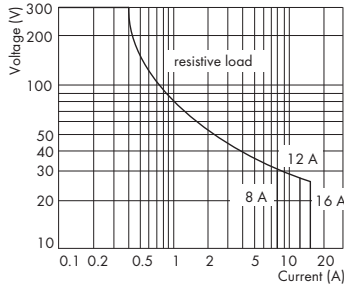

Contact life at lamp load	Switch. oper.
12 A, AC 250 V, $\cos \phi = 1$	3×10^5
TV 8 acc. UL 508	25×10^3
2500 W, 230 V AC halogen	$> 10^4$
1000 W, 250 V AC incandescent	2.3×10^5
3000 W, 250 V AC incandescent	3.6×10^4
1500 VA, fluorescent 163 μF	10^4

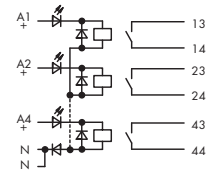
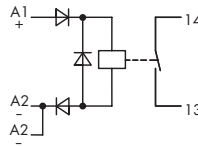

Description	V_N	I_N	Item No.	Pack. Unit	V_N	I_N	Item No.	Pack. Unit
Switching relay module	24 V DC	21.8 mA	288-320	1	24 V DC	21.8 mA	287-475	1

Technical Data

Input voltage range	$V_N -15\% \dots +20\%$	$V_N -15\% \dots +20\%$
Contact material	AgSnO ₂	AgSnO ₂
Max. switching voltage	440 V AC	440 V AC
Max. make / break current	4 s 25 A	4 s 25 A
Peak inrush current	20 ms/120 A	20 ms/120 A
Max. continuous current	16 A	16 A
Max. switching power (resistive)	4000 VA AC; DC see load limit curve	4000 VA AC; DC see load limit curve
Recommended minimum load	> 100 mA / 12 V AC/DC	> 100 mA / 12 V AC/DC
Pull-in / operating power	500 mW	500 mW
Pull-in/drop-out/bounce time typ.	8 ms / 2 ms / 2 ms	8 ms / 2 ms / 2 ms
Nominal operating mode	continuous duty	continuous duty
Dielectric strength contact-coil (AC, 1 min)	4 kV	4 kV
Dielectric strength open contact	1 kV	1 kV
Nominal voltage acc. to VDE 0110 Part 1/4.97, IEC 60664-1	250 V / 4 kV / 3	250 V / 4 kV / 3
Mechanical life	30×10^6 switching operations	30×10^6 switching operations
Service life at lamp load	see lamp load table	see lamp load table
Ambient operating temperature	-25 °C ... +40 °C	-25 °C ... +40 °C
Storage temperature	-40 °C ... +70 °C	-40 °C ... +70 °C
Dimensions (mm) L x W x H incl. mounting carrier and relay	20.5 x 47 x 85	64 x 47 x 85
Wire connection	Height from upper-edge of DIN 35 rail CAGE CLAMP® (WAGO 236 Series)	Height from upper-edge of DIN 35 rail CAGE CLAMP® (WAGO 236 Series)
Cross sections	0.08 mm ² ... 2.5 mm ² / AWG 28 ... 12	0.08 mm ² ... 2.5 mm ² / AWG 28 ... 12
Stripped lengths	5 ... 6 mm / 0.22 in	5 ... 6 mm / 0.22 in
Approvals	DIN VDE 0140 Part 18.01 for AC 250 V; DIN VDE 0160 and IEC 60255; DIN VDE 0435 (corresponding parts); UL 508	DIN VDE 0140 Part 18.01 for AC 250 V; DIN VDE 0160 and IEC 60255; DIN VDE 0435 (corresponding parts); UL 508, ©
Accessories		
WMB Multi marking system for mounting carrier	see page 323	see page 323
Marker strips for mounting carrier	white 709-198 / transparent 709-197	white 709-198 / transparent 709-197

	with 4 relays, 1 make contact each Relay direct soldered with universal mounting carrier	Bistable relay with 1 changeover contact Relay direct soldered with universal mounting carrier
--	--	--

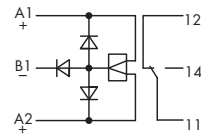
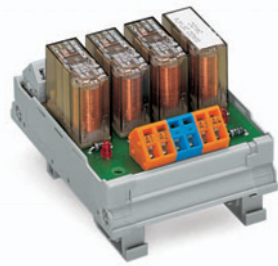
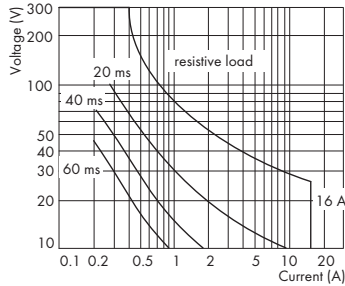

Description	V _N	I _N	Item No.	Pack. Unit	V _N	I _N	Item No.	Pack. Unit
Switching relay module	24 V DC	21.8 mA	287-474	1	24 V DC	41.5 mA	288-380	1

Technical Data

Input voltage range	V _N -15 % ... +20 %	V _N -15 % ... +20 %
Contact material	AgCdO	AgNi 0.15 + HV
Max. switching voltage	250 V DC / 250 V AC	300 V DC / 250 V AC
Max. make / break current	1 s 25 A (AC)	4 s 20 A / 8 A
Max. continuous current	16 A	6 A
Max. switching power (resistive)	4000 VA AC; DC see load limit curve	192 W / 1750 VA
Recommended minimum load	> 100 mA / 12 V AC/DC	
Pull-in / operating power	500 mW	261 mW / 533 mW
Pull-in/drop-out/bounce time typ.	8 ms / 2 ms / 2 ms	9 ms / 3 ms / 2 ms
Nominal operating mode	continuous duty	
Dielectric strength contact-coil (AC, 1 min)	4 kV	4 kV
Dielectric strength open contact	1 kV	
Nominal voltage acc. to VDE 0110 Part 1/4.97, IEC 60664-1	250 V / 4 kV / 3	250 V / 4 kV / 3
Mechanical life	30 x 10 ⁶ switching operations	30 x 10 ⁶ switching operations
Mechanical life at max. load (resistance)	1 x 10 ⁵ switching operations	1 x 10 ⁵ switching operations
Ambient operating temperature	-25 °C ... +40 °C	-25 °C ... +40 °C
Storage temperature	-40 °C ... +70 °C	
Dimensions (mm) L x W x H	64 x 47 x 85	20.5 x 48 x 85
incl. mounting carrier and relay		
Wire connection	Height from upper-edge of DIN 35 rail CAGE CLAMP® (WAGO 236 Series)	Height from upper-edge of DIN 35 rail CAGE CLAMP® (WAGO 236 Series)
Cross sections	0.08 mm ² ... 2.5 mm ² / AWG 28 ... 12	0.08 mm ² ... 2.5 mm ² / AWG 28 ... 12
Stripped lengths	5 ... 6 mm / 0.22 in	5 ... 6 mm / 0.22 in
Approvals	DIN VDE 0160 and IEC 60255; DIN VDE 0435 (corresponding parts), ©	
Accessories		
WMB Multi marking system for mounting carrier	see page 323	see page 323
Marker strips for mounting carrier	white 709-198 / transparent 709-197	white 709-198 / transparent 709-197

1 Rail Mounted Relay Modules

	Relay with 2 changeover contacts with forced operated contacts Relay direct soldered with universal mounting carrier	Switching relay module with 2 pluggable safety relays with 3 make contacts and 1 break contact with universal mounting carrier
--	--	--

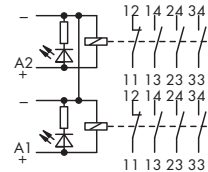
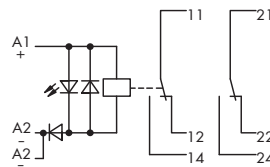

Description	V _N	I _N	Item No.	Pack. Unit	V _N	I _N	Item No.	Pack. Unit
Switching relay module	24 V DC	30 mA	288-437	1	24 V DC	50 mA	288-435	1

Technical Data			
Contact material	AgNi 10 + 5 µm Au	AgCdO + 0.2 µm Au	
Contact type	2 changeover contacts	3 make contacts / 1 break contact	
Max. switching voltage	380 V	300 V DC / 230 V AC	
Max. make / break current	0.3 A	10 A / 7 A	
Max. continuous current	5 A	6 A	
Max. switching power (resistive)	7 W / 7 VA	120 W / 2000 VA	
Recommended minimum load	1 mA / 100 mV AC/DC	300 mA / 12 V	
Pull-in / operating power	800 mW	1200 mW	
Max. switching rate		5 x / s	
Pull-in/drop-out/bounce time typ.	15 ms / 12 ms	23 ms / 20 ms	
Nominal operating mode	continuous duty	continuous duty	
Dielectric strength contact-coil (AC, 1 min)	4 kV	2.5 kV	
Nominal voltage acc. to VDE 01 10 Part 1/4.97, IEC 60664-1	250 V / 2.5 kV / 3		
Test voltage coil - contact	4 kV (1 min)	2500 V eff	
Test voltage contact - contact	1 kV (1 min)	2500 V eff	
Test voltage contacts - yoke		2500 V eff	
Mechanical life	50 x 10 ⁷ switching operations	1 x 10 ⁷ switching operations	
Mechanical life at max. load (resistance)	1 x 10 ⁵ switching operations		
Ambient operating temperature	-40 °C ... +85 °C	-25 °C ... +70 °C	
Relay fixing mechanism	soldered	plastic holden with locking latches (by relay manufacturer)	
Dimensions (mm) L x W x H incl. mounting carrier and relay	19 x 38 x 85	57 x 90 x 107	
Wire connection	Height from upper-edge of DIN 35 rail CAGE CLAMP® (WAGO 236 Series)	Height from upper-edge of DIN 35 rail CAGE CLAMP® (WAGO 736 Series)	
Cross sections	0.08 mm ² ... 2.5 mm ² / AWG 28 ... 12	0.08 mm ² ... 2.5 mm ² / AWG 28 ... 12	
Stripped lengths	5 ... 6 mm / 0.22 in	5 ... 6 mm / 0.22 in	
Accessories			
WMB Multi marking system for mounting carrier	see page 323	see page 323	
Marker strips for mounting carrier	white 709-198 / transparent 709-197	white 709-198 / transparent 709-197	

<p>If required a breathing hole can be made in the cover. However be aware that the degree of waterproof protection will reduce from IP67 to IP30!</p>	<p>Safety relay type SDS SF 4 with 4 break contacts and 4 make contacts with 1 relay with universal mounting carrier</p>	<p>Safety relay type SDS SF 4 with 4 break contacts and 4 make contacts with 2 relays with universal mounting carrier</p>
--	--	---

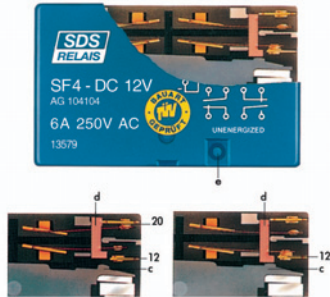

If an outer contact (20) should weld then the forced operated inner contact (12) driven by the actuator (d) remains open. The rotating armature (c) remains free to move. The unaffected contact pairs can operate normally, (i. e. their function to make or break remains unaffected).
 If an inner contact should weld (12) then the movement of the rotating armature (c) is blocked via the operator (d). Open contacts of all four contact pairs remain open. This arrangement corresponds to conventional, forced contact operation.

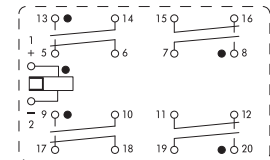
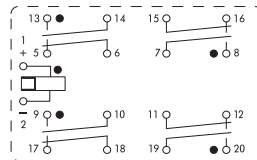

Description	V _N	I _N	Item No.	Pack. Unit	V _N	I _N	Item No.	Pack. Unit
Switching relay module	5 V DC	100 mA	288-412	1	5 V DC	100 mA	288-422	1
	12 V DC	41.7 mA	288-413	1	12 V DC	41.7 mA	288-423	1
	24 V AC/DC	20.9 mA	288-414	1	24 V AC/DC	20.9 mA	288-424	1
	48 V AC/DC	10.5 mA	288-415	1	48 V AC/DC	10.5 mA	288-425	1
	60 V AC/DC	8.4 mA	288-416	1	60 V AC/DC	8.4 mA	288-426	1
	230 V AC	9.4 mA	288-418	1	230 V AC	9.4 mA	288-428	1

Technical Data

Contact material	Ag Sn O 0.1 µm Au	Ag Sn O 0.1 µm Au
Max. switching voltage	250 V AC	250 V AC
Max. make / break current	20 A / 6 A	20 A / 6 A
Max. continuous current	6 A	6 A
Max. switching power (resistive)	150 W / 1500 VA	150 W / 1500 VA
Pull-in / operating power	280 mW / 500 mW	280 mW / 500 mW
Pull-in/drop-out/bounce time typ.	18 ms / 6 ms / 4 ms	18 ms / 6 ms / 4 ms
Dielectric strength contact-coil (AC, 1 min)	2.5 kV	2.5 kV
Nominal voltage acc. to VDE 0110 Part 1/4.97, IEC 60664-1	250 V / 2.5 kV / 3	250 V / 2.5 kV / 3
Mechanical life	1 x 10 ⁷ switching operations	1 x 10 ⁷ switching operations
Mechanical life at max. load (resistance)	1 x 10 ⁵ switching operations	1 x 10 ⁵ switching operations
Ambient operating temperature	-40 °C ... +70 °C	-40 °C ... +70 °C
Dimensions (mm) L x W x H	63.5 x 40 x 85	127 x 40 x 85
incl. mounting carrier and relay		
Wire connection	Height from upper-edge of DIN 35 rail CAGE CLAMP® (WAGO 256 Series)	Height from upper-edge of DIN 35 rail CAGE CLAMP® (WAGO 236 Series)
Cross sections	0.08 mm ² ... 2.5 mm ² / AWG 28 ... 12	0.08 mm ² ... 2.5 mm ² / AWG 28 ... 12
Stripped lengths	5 ... 6 mm / 0.22 in	5 ... 6 mm / 0.22 in
Relay Approvals	SEV approvals, no. D 3.31/192; SUVA approvals, no. 36 62 (delayed operation 5 Amp fuse); TÜV test no. 945/EL 178/88; UL recognized, file no. E 43149	SEV approvals, no. D 3.31/192; SUVA approvals, no. 36 62 (delayed operation 5 Amp fuse); TÜV test no. 945/EL 178/88; UL recognized, file no. E 43149
Accessories		
WMB Multi marking system for mounting carrier	see page 323	see page 323
Marker strips for mounting carrier	white 709-198 / transparent 709-197	white 709-198 / transparent 709-197

KAMMERRELAIS® is a registered trademark of the Siemens AG	Socket for European standard industrial relay, size 1 with 4 changeover contacts	Socket for KAMMRELAIS® Size I with 2 changeover contacts
---	--	--

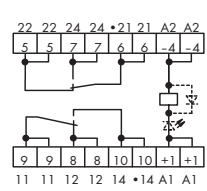
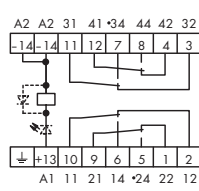
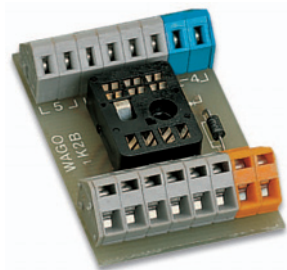
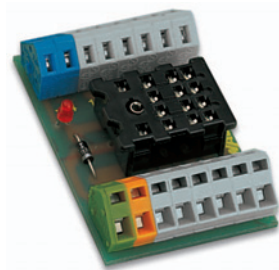

Description	Item No.	Pack. Unit	Item No.	Pack. Unit
Relay socket, for AC/DC relays	288-111	1	288-131	1
Relay socket, for DC relays with free-wheeling diode	288-112	1	288-132	1
Relay socket, for DC relays with free-wheeling diode and LED	288-113	1	288-133	1

Technical Data				
Relay enclosure	14-pole		8-pole	
Operating voltage (dependent on the relay voltage)	max. 250 V AC/DC		max. 250 V AC/DC	
Nominal current	5 A		5 A	
Max. coil current of the LED version	25 mA		25 mA	
Dimensions (mm) L x W x H incl. mounting carrier and universal mounting feet	42.5 x 32 x 62.5		42.5 x 32 x 62.5	
Wire connection	Height from upper-edge of DIN 35 rail CAGE CLAMP® (WAGO 236 Series)		Height from upper-edge of DIN 35 rail CAGE CLAMP® (WAGO 236 Series)	
Cross sections	0.08 mm² ... 2.5 mm² / AWG 28 ... 12 (THHN, THWN)		0.08 mm² ... 2.5 mm² / AWG 28 ... 12 (THHN, THWN)	
Stripped lengths	5 ... 6 mm / 0.22 in		5 ... 6 mm / 0.22 in	
Examples of suitable relays	Schrack RA4 and ZG4; Siemens V23 100; SDS HC 4; P+B KH/KHA; Aromat HC+HQ; OMRON MY; IDES RM/RY		Schrack ZL2; Siemens V23 154; Siemens V 23 162; SDS K2; P+B R 10; Aromat K	

Accessories	Item No.	Pack. Unit	Item No.	Pack. Unit
Mounting carrier, for screw-fixing or DIN-rail mounting (with snap-fit type universal mounting feet to be ordered separately)	288-001	1	288-001	1
Universal mounting foot; snap-fit type; suitable for DIN 15, 32 and 35 rails (also see page 258)	288-002	10	288-002	10

<p>KAMMERRELAIS® is a registered trademark of the Siemens AG</p>	<p>Socket for KAMMRELAIS® Size II with 4 changeover contacts</p>	
--	--	--

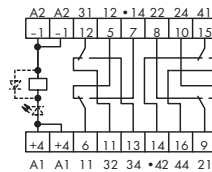
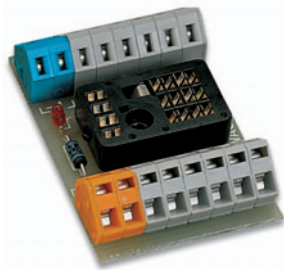

Description	Item No.	Pack. Unit
Relay socket, for AC/DC relays	288-151	1
Relay socket, for DC relays with free-wheeling diode	288-152	1
Relay socket, for DC relays with free-wheeling diode and LED	288-153	1

Technical Data

Relay enclosure	14-pole	
Operating voltage (dependent on the relay voltage)	max. 250 V AC/DC	
Nominal current	5 A	
Max. coil current of the LED version	25 mA	
Dimensions (mm) L x W x H incl. mounting carrier and universal mounting feet	42.5 x 32 x 62.5	
Wire connection	Height from upper-edge of DIN 35 rail	
Cross sections	CAGE CLAMP® (WAGO 236 Series)	
Stripped lengths	0.08 mm ² ... 2.5 mm ² / AWG 28 ... 12 (THHN, THWN)	
Examples of suitable relays	5 ... 6 mm / 0.22 in	
	Schrack ZL4; Siemens V23 154; Siemens V 23 162; SDS	
	K4; P+B R 10; Aromat K	

Accessories

Accessories	Item No.	Pack. Unit
Mounting carrier, for screw-fixing or DIN-rail mounting (with snap-fit type universal mounting feet to be ordered separately)	288-001	1
Universal mounting foot; snap-fit type; suitable for DIN 15, 32 and 35 rails (also see page 258)	288-002	10

	Relay with 1 make contact	Relay with 1 break contact
	Module width 10 mm / 0.394 in	Module width 10 mm / 0.394 in

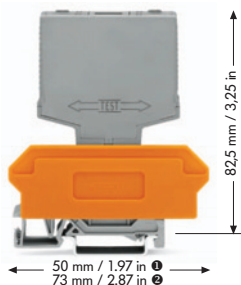

WSB marker cards

- Marking K; Item No.: 209-782
- Marking 1 ... 10; Item No.: 209-702
- Marking A1, A2, 13, 14; Item No.: 209-952
- Marking A1, A2, 11, 12; Item No.: 209-953

5 cards, each containing 10 strips with 10 markers

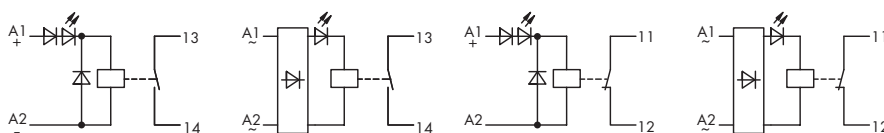

Description	V_N	I_N	Item No.	Pack. Unit	V_N	I_N	Item No.	Pack. Unit
Switching relay module	24 V DC	7.4 mA	286-364	1	24 V DC	20.4 mA	286-368	1
	48 V DC	8.6 mA	286-365	1	48 V DC	11.1 mA	286-369	1
	60 V DC	7.3 mA	286-366	1	60 V DC	10.7 mA	286-370	1
	24 V AC	10.2 mA	286-564	1	24 V AC	18.5 mA	286-568	1
	115 V AC	10.5 mA	286-566	1				
	230 V AC	7.3 mA	286-567	1				

Technical Data

Accessories see page 138 ... 139

Accessories see page 138 ... 139

Technical Data	Accessories see page 138 ... 139	Accessories see page 138 ... 139
Contact material	Ag Cd O + 1 μ Au	Ag Cd O
Max. switching voltage	30 V DC / 250 V AC	250 V DC / 250 V AC
Max. make / break current	5 A / 5 A	8 A / 8 A
Max. continuous current	5 A	5 A
Max. Switching power (resistive)	150 W / 1250 VA	150 W / 1250 VA
Pull-in / operating power	100 mW / 200 mW	300 mW / 450 mW
Pull-in/drop-out/bounce time typ.	6 ms / 6 ms / 2 ms	10 ms / 4 ms / 3 ms
Dielectric strength contact-coil (AC, 1 min)	2.5 kV	4 kV
Nominal voltage acc. to VDE 0110 Part 1/4.97, IEC 60664-1	250 V / 2.5 kV / 3	250 V / 4 kV / 3
Mechanical life	2×10^7 switching operations	1×10^7 switching operations
Mechanical life at max. load (resistance)	1×10^5 switching operations	1×10^5 switching operations
Ambient operating temperature	-25 °C ... +40 °C	-25 °C ... +40 °C

Accessories

Accessories	Item No.	Pack. Unit	Item No.	Pack. Unit
Terminal block for pluggable modules, with 2-conductor terminal blocks, orange separator ①	12 mm / 0.472 in 280-618	1	12 mm / 0.472 in 280-618	1
with 4-conductor terminal blocks, orange separator ②	12 mm / 0.472 in 280-608	1	12 mm / 0.472 in 280-608	1
with 4-conductor terminal blocks, marker plate ③	15 mm / 0.591 in 280-762	1	15 mm / 0.591 in 280-762	1
wire range 0.08 mm ² ... 2.5 mm ² / AWG 28 ... 14; stripped length 8 ... 9 mm / 0.33 in				

	Relay with 1 changeover contact	Relay with 1 changeover contact
	Module width 15 mm / 0.591 in	Module width 15 mm / 0.591 in

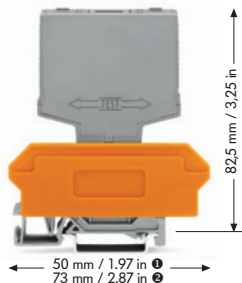

WSB marker cards

- Marking K; Item No.: 209-782
- Marking 1 ... 10; Item No.: 209-702
- Marking A1, A2, A2, 11, 12, 14, A1, A2, A2; Item No.: 209-994

5 cards, each containing 10 strips with 10 markers

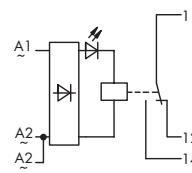
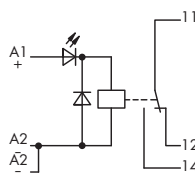

Description	V _N	I _N	Item No.	Pack. Unit	V _N	I _N	Item No.	Pack. Unit
Switching relay module	5/6 V DC	94.3 mA	286-302	1	5/6 V AC/DC	94.3 mA	286-502	1
	12 V DC	49.4 mA	286-303	1	12 V AC/DC	49.4 mA	286-503	1
	24 V DC	19.4 mA	286-304	1	24 V AC/DC	21.8 mA	286-504	1
	48 V DC	11.4 mA	286-305	1	48 V AC/DC	11.4 mA	286-505	1
	60 V DC	9.2 mA	286-306	1	60 V AC/DC	9.2 mA	286-506	1
	115 V DC	4.8 mA	286-307	1	115 V AC	4.8 mA	286-507	1
	220 V DC	6.1 mA	286-308	1	230 V AC	6.1 mA	286-508	1

Technical Data

Accessories see page 138 ... 139

Accessories see page 138 ... 139

Contact material	AgNi 0.15 + HV	AgNi 0.15 + HV
Max. switching voltage	300 V DC / 250 V AC	300 V DC / 250 V AC
Max. make / break current	16 A / 8 A (10 % continuous duty)	16 A / 8 A (10 % continuous duty)
Max. continuous current	7 A	7 A
Max. switching power (resistive)	192 W / 1750 VA	192 W / 1750 VA
Pull-in / operating power	261 mW / 533 mW	261 mW / 533 mW
Pull-in/drop-out/bounce time typ.	8 ms / 6 ms / 4 ms	8 ms / 6 ms / 4 ms
Dielectric strength contact-coil (AC, 1 min)	4 kV	4 kV
Nominal voltage acc. to VDE 01 10 Part 1/4.97, IEC 60664-1	250 V / 4 kV / 3	250 V / 4 kV / 3
Mechanical life	30 x 10 ⁶ switching operations	30 x 10 ⁶ switching operations
Mechanical life at max. load (resistance)	1 x 10 ⁵ switching operations	1 x 10 ⁵ switching operations
Ambient operating temperature	-25 °C ... +40 °C	-25 °C ... +40 °C

Accessories

	Item No.	Pack. Unit	Item No.	Pack. Unit
Terminal block for pluggable modules, with 2-conductor terminal blocks, orange separator ①	17 mm / 0.669 in 280-619	1	17 mm / 0.669 in 280-619	1
with 4-conductor terminal blocks, orange separator ②	17 mm / 0.669 in 280-609	1	17 mm / 0.669 in 280-609	1
with 4-conductor terminal blocks, marker plate ③	20 mm / 0.787 in 280-763	1	20 mm / 0.787 in 280-763	1
wire range 0.08 mm² ... 2.5 mm² / AWG 28 ... 14; stripped length 8 ... 9 mm / 0.33 in				

	<p>Relay with 1 changeover contact Contact 5 µm hard gold plated</p> <p>Module width 15 mm / 0.591 in</p>	
--	---	--

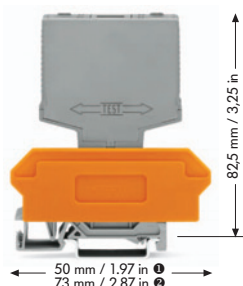

WSB marker cards

- Marking K; Item No.: 209-782
- Marking 1 ... 10; Item No.: 209-702
- Marking A1, A2, A2, 11, 12, 14, A1, A2, A2; Item No.: 209-994

5 cards, each containing 10 strips with 10 markers

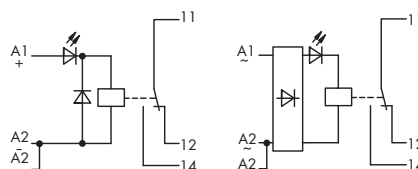

Description	V _N	I _N	Item No.	Pack. Unit
Switching relay module	24 V DC	21.8 mA	286-394	1
	48 V DC	11.4 mA	286-395	1
	24 V AC/DC	21.8 mA	286-594	1

Technical Data

Accessories see page 138 ... 139

Contact material	AgNi + 5µ Au			
Max. switching voltage	36 V DC			
Max. continuous current	1 A			
Max. Switching power (resistive)	25 W / -			
Pull-in / operating power	261 mW / 533 mW			
Pull-in/drop-out/bounce time typ.	9 ms / 3 ms / 2 ms			
Dielectric strength contact-coil (AC, 1 min)	4 kV			
Nominal voltage acc. to VDE 0110 Part 1/4.97, IEC 60664-1	250 V / 4 kV / 3			
Mechanical life	30 x 10 ⁵ switching operations			
Mechanical life at max. load (resistance)	1 x 10 ⁵ switching operations			
Ambient operating temperature	-25 °C ... +40 °C			

Accessories

	Item No.	Pack. Unit	Item No.	Pack. Unit
Terminal block for pluggable modules, with 2-conductor terminal blocks, orange separator ❶	17 mm / 0.669 in	280-619		1
with 4-conductor terminal blocks, orange separator ❷	17 mm / 0.669 in	280-609		1
with 4-conductor terminal blocks, marker plate ❸	20 mm / 0.787 in	280-763		1
wire range 0.08 mm ² ... 2.5 mm ² / AWG 28 ... 14; stripped length 8 ... 9 mm / 0.33 in				

	Relay with 2 changeover contacts	Relay with 2 changeover contacts
	Module width 20 mm / 0.787 in	Module width 20 mm / 0.787 in

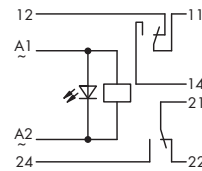
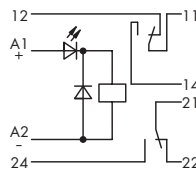
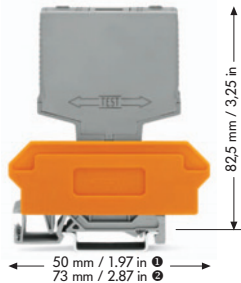

WSB marker cards

- Marking K; Item No.: 209-782
- Marking 1 ... 10; Item No.: 209-702
- Marking 12, A1, A2, 24, 11, 14, 21, 22; Item No.: 209-995

5 cards, each containing 10 strips with 10 markers

Description	V _N	I _N	Item No.	Pack. Unit	V _N	I _N	Item No.	Pack. Unit
Switching relay module	5/6 V DC	82.8 mA	286-310	1	5/6 V AC	174 mA	286-510	1
	12 V DC	46.1 mA	286-311	1	12 V AC	89 mA	286-511	1
	24 V DC	21.8 mA	286-312	1	24 V AC	47 mA	286-512	1
	48 V DC	10.3 mA	286-313	1	48 V AC	23.3 mA	286-513	1
	60 V DC	8.8 mA	286-314	1	60 V AC	18.1 mA	286-514	1
	115 V DC	4.9 mA	286-315	1	115 V AC	10.5 mA	286-515	1
	220 V DC	5 mA	286-316	1	230 V AC	5.5 mA	286-516	1

Technical Data

Accessories see page 138 ... 139

Accessories see page 138 ... 139

Contact material	Ag Ni 0.15	Ag Ni 0.15
Max. switching voltage	300 V DC / 250 V AC	300 V DC / 250 V AC
Max. make / break current	0.2 s 30 A / 10 A	0.2 s 30 A / 10 A
Max. continuous current	7 A	7 A
Max. switching power (resistive)	210 W / 1750 VA	210 W / 1750 VA
Pull-in / operating power	600 mW / 1000 mW	0.8 VA / 1 VA
Pull-in/drop-out/bounce time typ.	18 ms / 3 ms / 2 ms	15 ms / 5 ms / 2 ms
Dielectric strength contact-coil (AC, 1 min)	4 kV	4 kV
Nominal voltage acc. to VDE 01 10 Part 1/4.97, IEC 60664-1	250 V / 4 kV / 3	250 V / 4 kV / 3
Mechanical life	30 x 10 ⁷ switching operations	30 x 10 ⁷ switching operations
Mechanical life at max. load (resistance)	2.5 x 10 ⁵ switching operations	2.5 x 10 ⁵ switching operations
Ambient operating temperature	-25 °C ... +40 °C	-25 °C ... +40 °C

Accessories

	Item No.	Pack. Unit	Item No.	Pack. Unit
Terminal block for pluggable modules, with 2-conductor terminal blocks, orange separator ①	22 mm / 0.866 in 280-638	1	22 mm / 0.866 in 280-638	1
with 4-conductor terminal blocks, orange separator ②	22 mm / 0.866 in 280-628	1	22 mm / 0.866 in 280-628	1
with 4-conductor terminal blocks, marker plate ③	25 mm / 0.984 in 280-764	1	25 mm / 0.984 in 280-764	1
wire range 0.08 mm² ... 2.5 mm² / AWG 28 ... 14; stripped length 8 ... 9 mm / 0.33 in				

	Relay with 1 break and 1 make contact	Relay with 2 make contacts
	Module width 20 mm / 0.787 in	Module width 20 mm / 0.787 in

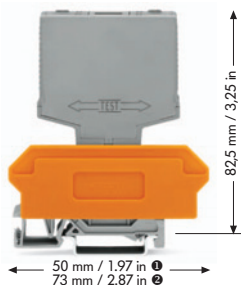

WSB marker cards

- Marking K; Item No.: 209-782
- Marking 1 ... 10; Item No.: 209-702
- Marking A1, A1, A2, A2, 11, 12, 13, 14, 23, 24; Item No.: 209-693

5 cards, each containing 10 strips with 10 markers

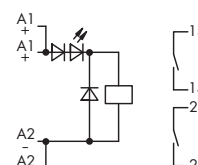
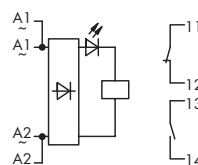
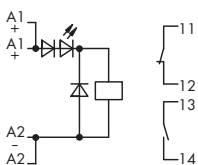

Description	V _N	I _N	Item No.	Pack. Unit	V _N	I _N	Item No.	Pack. Unit
Switching relay module	5/6 V DC	47.2 mA	286-318	1	5/6 V DC	47.2 mA	286-326	1
	12 V DC	19.9 mA	286-319	1	12 V DC	19.9 mA	286-327	1
	24 V DC	7.4 mA	286-320	1	24 V DC	7.4 mA	286-328	1
	48 V DC	3.9 mA	286-321	1	48 V DC	3.9 mA	286-329	1
	60 V DC	3.9 mA	286-322	1	60 V DC	3.9 mA	286-330	1
	220 V DC	3.7 mA	286-324	1	220 V DC	3.7 mA	286-332	1
	24 V AC	8.3 mA	286-520	1				

Technical Data

Accessories see page 138 ... 139

Accessories see page 138 ... 139

Technical Data	Item No.	Pack. Unit	Item No.	Pack. Unit
Contact material	Ag Sn O ₂		Ag Sn O ₂	
Max. switching voltage	250 V DC / 380 V AC		250 V DC / 380 V AC	
Max. make / break current	1 s 15 A / 8 A		1 s 15 A / 8 A	
Max. continuous current	6 A		6 A	
Max. Switching power (resistive)	150 W / 2000 VA		150 W / 2000 VA	
Pull-in / operating power	150 mW / 240 mW		150 mW / 240 mW	
Pull-in/drop-out/bounce time typ.	10 ms / 4 ms / 1 ms		10 ms / 4 ms / 1 ms	
Dielectric strength contact-coil (AC, 1 min)	3 kV		3 kV	
Nominal voltage acc. to VDE 0110 Part 1/4.97, IEC 60664-1	250 V / 4 kV / 3		250 V / 4 kV / 3	
Mechanical life	5 x 10 ⁷ switching operations		5 x 10 ⁷ switching operations	
Mechanical life at max. load (resistance)	1 x 10 ⁵ switching operations		1 x 10 ⁵ switching operations	
Ambient operating temperature	-25 °C ... +40 °C		-25 °C ... +40 °C	

Accessories

Accessories	Item No.	Pack. Unit	Item No.	Pack. Unit
Terminal block for pluggable modules, with 2-conductor terminal blocks, orange separator ❶	22 mm / 0.866 in 280-638	1	22 mm / 0.866 in 280-638	1
with 4-conductor terminal blocks, orange separator ❷	22 mm / 0.866 in 280-628	1	22 mm / 0.866 in 280-628	1
with 4-conductor terminal blocks, marker plate ❸	25 mm / 0.984 in 280-764	1	25 mm / 0.984 in 280-764	1
wire range 0.08 mm ² ... 2.5 mm ² / AWG 28 ... 14; stripped length 8 ... 9 mm / 0.33 in				

	<p>Relay with 2 break contacts and 2 make contacts</p> <p>Module width 25 mm / 0.984 in</p>	<p>Relay with 1 break contact and 3 make contacts</p> <p>Module width 25 mm / 0.984 in</p>
--	---	--

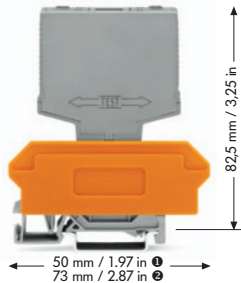

WSB marker cards

- Marking K; Item No.: 209-782
- Marking 1 ... 10; Item No.: 209-702
- Marking 12, A1, A2, 23, 24, 11, 13, 14, 21, 22; Item No.: 209-691
- Marking 12, A1, A2, 23, 24, 11, 13, 14, 33, 34; Item No.: 209-690

5 cards, each containing 10 strips with 10 markers

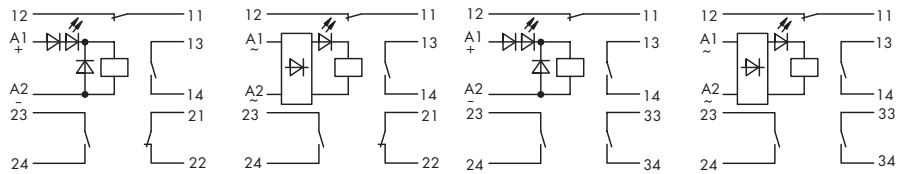

Description	V _N	I _N	Item No.	Pack. Unit	V _N	I _N	Item No.	Pack. Unit
Switching relay module	5/6 V DC	42.3 mA	286-334	1	5/6 V DC	42.3 mA	286-342	1
	12 V DC	22.2 mA	286-335	1	12 V DC	22.2 mA	286-343	1
	24 V DC	8.5 mA	286-336	1	24 V DC	8.5 mA	286-344	1
	48 V DC	5.7 mA	286-337	1	48 V DC	5.7 mA	286-345	1
	60 V DC	5.7 mA	286-338	1	60 V DC	5.7 mA	286-346	1
	115 V DC	6.6 mA	286-339	1	115 V DC	6.6 mA	286-347	1
	24 V AC	11.2 mA	286-536	1	24 V AC	11.2 mA	286-544	1
	230 V AC	16.2 mA	286-540	1	115 V AC	10.6 mA	286-547	1
					230 V AC	16.2 mA	286-548	1

Technical Data

Accessories see page 138 ... 139

Accessories see page 138 ... 139

Parameter	Value	Value
Contact material	AuAg10 over AgNi 15	Au Ag 10 over Ag Ni 15
Max. switching voltage	250 V DC / 250 V AC	250 V DC / 250 V AC
Max. make / break current	20 A / 5 A	20 A / 5 A
Max. continuous current	5 A	5 A
Max. switching power (resistive)	100 W / 1000 VA	100 W / 1000 VA
Pull-in / operating power	50 mW / 205 mW	50 mW / 205 mW
Pull-in/drop-out/bounce time typ.	8 ms / 5 ms / 1 ms	9 ms / 5 ms / 2 ms
Dielectric strength contact-coil (AC, 1 min)	1.5 kV	1.5 kV
Nominal voltage acc. to VDE 0110 Part 1/4.97, IEC 60664-1	250 V / 2.5 kV / 3	250 V / 2.5 kV / 3
Mechanical life	2 x 10 ⁸ switching operations	2 x 10 ⁸ switching operations
Mechanical life at max. load (resistance)	1 x 10 ⁵ switching operations	1 x 10 ⁵ switching operations
Ambient operating temperature	-25 °C ... +40 °C	-25 °C ... +40 °C

Accessories

Item No.

Pack. Unit

Item No.

Pack. Unit

Terminal block for pluggable modules, with 2-conductor terminal blocks, orange separator ①	27 mm / 1.063 in	280-639	1	27 mm / 1.063 in	280-639	1
with 4-conductor terminal blocks, orange separator	27 mm / 1.063 in	280-629	1	27 mm / 1.063 in	280-629	1
with 4-conductor terminal blocks, marker plate ②	30 mm / 1.181 in	280-765	1	30 mm / 1.181 in	280-765	1
wire range 0.08 mm ² ... 2.5 mm ² / AWG 28 ... 14; stripped length 8 ... 9 mm / 0.33 in						

	Relay with 4 make contacts	Relay with 4 changeover contacts
	Module width 25 mm / 0.984 in	Module width 35 mm / 1.378 in

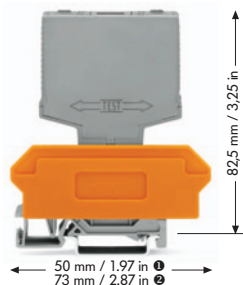

WSB marker cards

- Marking K; Item No.: 209-782
- Marking 1 ... 10; Item No.: 209-702
- Marking 14, A1, A2, 33, 34, 13, 23, 24, 43, 44; Item No.: 209-692
- Marking A1, A2, 32, 31, 34, 42, 41, 12, 11, 14; Item No.: 249-656

5 cards, each containing 10 strips with 10 markers

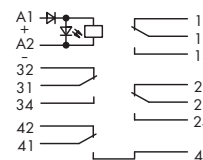
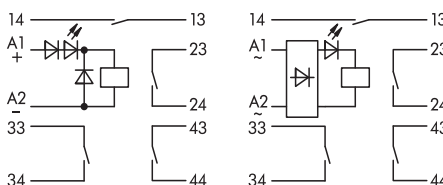

Description	V _N	I _N	Item No.	Pack. Unit	V _N	I _N	Item No.	Pack. Unit
Switching relay module	5/6 V DC	42.3 mA	286-350	1	24 V DC	32 mA	286-375	1
	12 V DC	22.2 mA	286-351	1	110/120 V AC	9.2 mA	286-578	1
	24 V DC	8.5 mA	286-352	1	230 V AC	9.9 mA	286-579	1
	48 V DC	5.7 mA	286-353	1				
	60 V DC	5.7 mA	286-354	1				
	115 V DC	6.6 mA	286-355	1				
	24 V AC	11.2 mA	286-552	1				
	115 V AC	10.6 mA	286-555	1				
	230 V AC	16.2 mA	286-556	1				

Technical Data

Accessories see page 138 ... 139

Accessories see page 138 ... 139

Technical Data	Item No.	Pack. Unit	Item No.	Pack. Unit
Contact material	Au Ag 10 over Ag Ni 15		Ag	
Max. switching voltage	250 V DC / 250 V AC		60 V DC / 250 V AC	
Max. make / break current	20 A / 5 A		4 A AC / 2 A DC	
Max. continuous current	5 A		4 A AC/DC	
Max. Switching power (resistive)	100 W / 1000 VA		50 W / 1000 VA	
Pull-in / operating power	50 mW / 205 mW		50 mW / 205 mW	
Pull-in/drop-out/bounce time typ.	10 ms / 5 ms / 2 ms		6 ms / - / 2 ms	
Dielectric strength contact-coil (AC, 1 min)	1.5 kV		1.5 kV	
Nominal voltage acc. to VDE 0110 Part 1/4.97, IEC 60664-1	250 V / 2.5 kV / 3		250 V / 4 kV / 3	
Mechanical life	2 x 10 ⁸ switching operations		5 x 10 ⁷ switching operations	
Mechanical life at max. load (resistance)	1 x 10 ⁵ switching operations		1 x 10 ⁵ switching operations	
Ambient operating temperature	-25 °C ... +40 °C		-25 °C ... +40 °C	

Accessories

Accessories	Item No.	Pack. Unit	Item No.	Pack. Unit
Terminal block for pluggable modules, with 2-conductor terminal blocks, orange separator ①	27 mm / 1.063 in 280-639	1		
with 4-conductor terminal blocks, orange separator ②	27 mm / 1.063 in 280-629	1	37 mm / 1.457 in 280-636	1
with 4-conductor terminal blocks, marker plate ③	30 mm / 1.181 in 280-765	1		
wire range 0.08 mm ² ... 2.5 mm ² / AWG 28 ... 14; stripped length 8 ... 9 mm / 0.33 in				

	<p>Relay with 1 make contact for higher DC loads</p> <p>Module width 15 mm / 0.591 in</p>	<p>Relay with 2 changeover contacts Contacts 5 µm Au</p> <p>Module width 20 mm / 0.787 in</p>
--	---	--

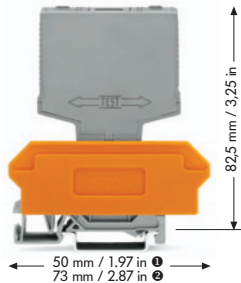

* In order to prevent the gold layer from being damaged these values should not be exceeded. Higher switching power leads to evaporation of the gold layer. The resulting deposits in the enclosure may cause sparkovers between the coil and the contact.

WSB marker cards

- Marking K; Item No.: 209-782
- Marking 1 ... 10; Item No.: 209-702
- Marking 12, A1, A2, 24, 11, 14, 21, 22; Item No.: 209-995

5 cards, each containing 10 strips with 10 markers

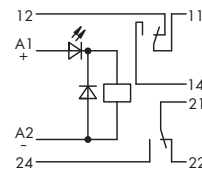
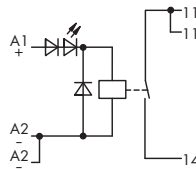

Description	V _N	I _N	Item No.	Pack. Unit	V _N	I _N	Item No.	Pack. Unit
Switching relay module	24 V DC	20 mA	286-376	1	24 V DC	19.4 mA	286-384	1

Technical Data

Accessories see page 138 ... 139

Accessories see page 138 ... 139

Contact material	AgNi 0.15	AgCdO + 5 µm Au
Max. switching voltage	250 V DC / 250 V AC	36 V DC *
Max. make current (resistive)	4 s 14A	
Max. break current 250 V DC/ 110 V DC/ 60 V DC	0.6 A / 1.7 A / 5 A	0.6 A / 1.7 A / 5 A
Recommended minimum load	> 12 V / 10 mA AC/DC	10 µA / 100 mV
Max. switching rate with / without load	10 min ⁻¹ / 1200 min ⁻¹	
Max. continuous current	5 A	50 mA *
Max. Switching power (resistive)	2000 VA	
Max. switching power 250 V DC/ 110 V DC/ 60 V DC	150 W / 187 W / 300 W	150 W / 187 W / 300 W
Pull-in / operating power	480 mW	500 mW
Pull-in/drop-out/bounce time typ.	9 ms / 3 ms / 5 ms	9 ms / 3 ms / 3 ms
Dielectric strength contact-coil (AC, 1 min)	4 kV	4 kV
Dielectric strength open contact	2 kV	1 kV
Nominal voltage acc. to VDE 0110 Part 1/4.97, IEC 60664-1	250 V / 4 kV / 3	250 V / 4 kV / 3
Mechanical life	20 x 10 ⁶ switching operations	1 x 10 ⁷ switching operations
Mechanical life at max. load (resistance)		1 x 10 ⁵ switching operations
Mechanical life at max. load DC (resistive)	2 x 10 ⁵ switching operations	
Mechanical life at max. resistive load AC	3 x 10 ⁵ switching operations	
Ambient operating temperature	-25 °C ... +40 °C	-25 °C ... +40 °C
Approvals	DIN VDE 01110/1.89 / DIN VDE 0160 and IEC 60255 / DIN VDE 0435 (corresponding parts)	

Accessories

	Item No.	Pack. Unit	Item No.	Pack. Unit
Terminal block for pluggable modules, with 2-conductor terminal blocks, orange separator ①	17 mm / 0.669 in 280-619	1	22 mm / 0.866 in 280-638	1
with 4-conductor terminal blocks, orange separator ②	17 mm / 0.669 in 280-609	1	22 mm / 0.866 in 280-628	1
with 4-conductor terminal blocks, marker plate ③	20 mm / 0.787 in 280-763	1	25 mm / 0.984 in 280-764	1
Wire range 0.08 mm ² ... 2.5 mm ² / AWG 28 ... 14; stripped length 8 ... 9 mm / 0.33 in				

	Switching relay with specified switching treshold: $V_{on} 180 V \pm 10 \%$ $V_{off} 150 V \pm 10 \%$; 1 changeover contact Module width 15 mm / 0.591 in	Low power (≥ 7 mW) relay module Low power drive relay (0.3 mA) through amplifier $V_{cc} = DC 24 V$ 1 break and 1 make contact Module width 20 mm / 0.787 in
--	---	--

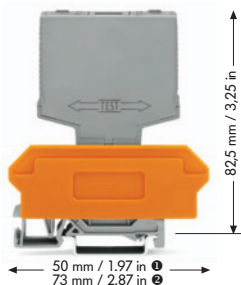

WSB marker cards

- Marking K; Item No.: 209-782
- Marking 1 ... 10; Item No.: 209-702
- Marking A1, A2, A2, 11, 12, 14, A1, A2, A2; Item No.: 209-994
- Marking L+, 1, L, L, 11, 12, 13, 14; Item No.: 209-954

5 cards, each containing 10 strips with 10 markers

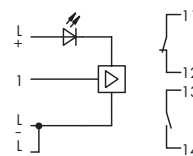
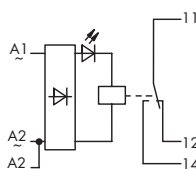

Description	V_N	I_N	Item No.	Pack. Unit	V_N	I_N	Item No.	Pack. Unit
Switching relay module	230 V AC	4 mA	286-904	1	24 V DC	10 mA	286-906	1

Technical Data

Accessories see page 138 ... 139

Accessories see page 138 ... 139

Parameter	286-904	286-906
Contact material	AgCdO	AgCdO, with gold flash
Max. switching voltage	250 V DC / 380 V AC	250 V DC / 380 V AC
Max. make / break current	4 s 25 A / 18 A	1 s 15 A / 8 A
Max. continuous current	5 A	6 A
Max. Switching power (resistive)	90 W / 1900 VA	150 W / 2000 VA
Pull-in / operating power	0.8 VA / 1 VA	150 mW / 240 mW
Pull-in/drop-out/bounce time typ.	10 ms / 5 ms / 5 ms	10 ms / 4 ms / 1 ms
Dielectric strength contact-coil (AC, 1 min)	4 kV	3 kV
Nominal voltage acc. to VDE 0110 Part 1/4.97, IEC 60664-1	250 V / 4 kV / 3	250 V / 4 kV / 3
Mechanical life	5×10^7 switching operations	5×10^7 switching operations
Mechanical life at max. load (resistance)	1×10^5 switching operations	1×10^5 switching operations
Ambient operating temperature	-25 °C ... +40 °C	-25 °C ... +40 °C
Turn-on treshold relay / status indication	$180 V \pm 10 \%$ / $122 V \pm 10 \%$	
Turn-off treshold relay / status indication	$150 V \pm 10 \%$ / $113 V \pm 10 \%$	
Control voltage output 0		-2 V ... 3 V DC
Control voltage output 1		8 V ... 30 V DC

Accessories

Item No.	Pack. Unit	Item No.	Pack. Unit
Terminal block for pluggable modules, with 2-conductor terminal blocks, orange separator ①	17 mm / 0.669 in	280-619	1
with 4-conductor terminal blocks, orange separator ②	17 mm / 0.669 in	280-609	1
with 4-conductor terminal blocks, marker plate ③	20 mm / 0.787 in	280-763	1
wire range 0.08 mm ² ... 2.5 mm ² / AWG 28 ... 14; stripped length 8 ... 9 mm / 0.33 in			

	<p>Latching relay with 1 break contact and 1 make contact</p> <p>Module width 20 mm / 0.787 in</p>	<p>Bistable relay with 1 changeover contact positive switching, negative switching</p> <p>Module width 15 mm / 0.591 in</p>
--	---	--

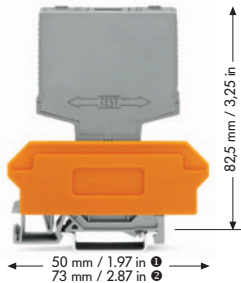

WSB marker cards

- Marking K; Item No.: 209-782
- Marking 1 ... 10; Item No.: 209-702
- Marking A1, A1, A2, A2, 11, 12, 13, 14, 23, 24; Item No.: 209-693
- Marking A1, A3, A2, 11, 12, 14; Item No.: 249-607

5 cards, each containing 10 strips with 10 markers

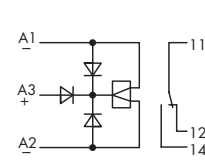
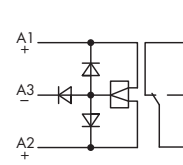
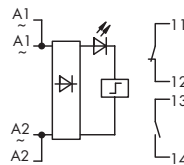
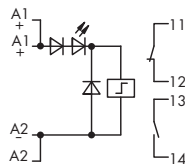

Description	V _N	I _N	Item No.	Pack. Unit	V _N	I _N	Item No.	Pack. Unit
Switching relay module	24 V DC	20.9 mA	286-571	1	24 V DC	41.5 mA	286-380	1
	230 V AC	20.9 mA	286-570	1	24 V DC	41.5 mA	286-381	1

Technical Data

Accessories see page 138 ... 139

Accessories see page 138 ... 139

Contact material	AuAg10 over AgNi 15	AgNi 0.15 + HV
Max. switching voltage	30 V DC / 250 V AC	250 V DC / 250 V AC
Max. make / break current	20 A / 5 A	20 A / 8 A
Max. continuous current	5 A	6 A
Max. switching power (resistive)	100 W / 1000 VA	192 W / 1500 VA
Pull-in / operating power	50 mW / 205 mW	261 mW / 533 mW
Pull-in/drop-out/bounce time typ.	8 ms / 5 ms / 1 ms	9 ms / 3 ms / 2 ms
Dielectric strength contact-coil (AC, 1 min)	1.5 kV	4 kV
Nominal voltage acc. to VDE 0110 Part 1/4.97, IEC 60664-1	250 V / 4 kV / 3	250 V / 4 kV / 3
Mechanical life	2 x 10 ⁸ switching operations	30 x 10 ⁶ switching operations
Mechanical life at max. load (resistance)	1 x 10 ⁵ switching operations	1 x 10 ⁵ switching operations
Ambient operating temperature	-25 °C ... +40 °C	-25 °C ... +40 °C

Accessories

	Item No.	Pack. Unit	Item No.	Pack. Unit
Terminal block for pluggable modules, with 2-conductor terminal blocks, orange separator ①	22 mm / 0.866 in 280-638	1	17 mm / 0.669 in 280-619	1
with 4-conductor terminal blocks, orange separator ②	22 mm / 0.866 in 280-628	1	17 mm / 0.669 in 280-609	1
with 4-conductor terminal blocks, marker plate ③	25 mm / 0.984 in 280-764	1	20 mm / 0.787 in 280-763	1
wire range 0.08 mm ² ... 2.5 mm ² / AWG 28 ... 14; stripped length 8 ... 9 mm / 0.33 in				

	On-delay timing 1 changeover contact specified time acc. to IEC 255, part 1 Module width 20 mm / 0.787 in	On-delay timing 1 changeover contact specified time acc. to IEC 255, part 1 Module width 20 mm / 0.787 in
--	--	--

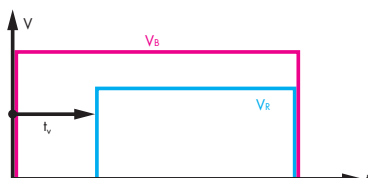

V_B = operating voltage; V_{Si} = control voltage; V_R = voltage on relay; t_v = delay time



On-delay time relay
 V_B on A1+ and A2- applied: relay stays in rest position
 delay time t_v is over: relay switches to working condition
 WSB marker cards
 • Marking K; Item No.: 209-782
 • Marking 1 ... 10; Item No.: 209-702
 • Marking A1, A1, A2, A2, 12, 11, 11, 14;
 Item No.: 209-996
 5 cards, each containing 10 strips with 10 markers

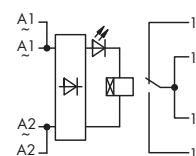
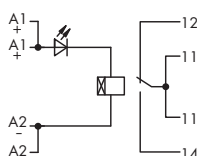

Description	Time range	Item No.	Pack. Unit	Time range	Item No.	Pack. Unit
Time relay module	0.1 - 1 s	286-600	1	0.1 - 1 s	286-610	1
	1 - 10 s	286-602	1	1 - 10 s	286-612	1
	10 - 100 s	286-604	1	10 - 100 s	286-614	1

Technical Data

Accessories see pages 138 ... 139

Accessories see pages 138 ... 139

Nominal input voltage (V_N)	24 V DC	230 V AC
Current input at rated voltage (coil 20 °C)	12.5 mA	14.4 mA
Contact material	AgCdO, with gold flash	AgCdO, with gold flash
Max. switching voltage	250 V DC / 380 V AC	250 V DC / 380 V AC
Max. make / break current	1 s 15 A / 5 A	1 s 15 A / 5 A
Max. continuous current	6 A	6 A
Max. Switching power (resistive)	150 W / 2000 VA	150 W / 2000 VA
Operating power	300 mW	3.3 VA
Pull-in/drop-out/bounce time typ.	0 ms / 15 ms / 1 ms	0 ms / 15 ms / 1 ms
Reset time	100 ms	100 ms
Repeat accuracy	±0.5 %	±0.5 %
Dielectric strength contact-coil (AC, 1 min)	3 kV	3 kV
Nominal voltage acc. to VDE 0110 Part 1/4.97, IEC 60664-1	250 V / 4 kV / 3	250 V / 4 kV / 3
Mechanical life	5 x 10 ⁷ switching operations	5 x 10 ⁷ switching operations
Mechanical life at max. load (resistance)	1 x 10 ⁵ switching operations	1 x 10 ⁵ switching operations
Ambient operating temperature	-25 °C ... +40 °C	-25 °C ... +40 °C
Dimensions (mm) L x H x W incl. terminal block	20 x 82.5 x 50	20 x 82.5 x 50

Accessories

	Item No.	Pack. Unit	Item No.	Pack. Unit
Terminal block for pluggable modules, with 2-conductor terminal blocks, orange separator ①	22 mm / 0.866 in 280-638	1	22 mm / 0.866 in 280-638	1
with 4-conductor terminal blocks, orange separator ②	22 mm / 0.866 in 280-628	1	22 mm / 0.866 in 280-628	1
with 4-conductor terminal blocks, marker plate ③	25 mm / 0.984 in 280-764	1	25 mm / 0.984 in 280-764	1
wire range 0.08 mm ² ... 2.5 mm ² / AWG 28 ... 14; stripped length 8 ... 9 mm / 0.33 in				

	Pulse lengthening, with trigger voltage 1 changeover contact	
Module width 20 mm / 0.787 in		

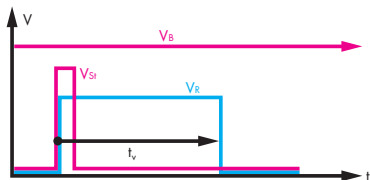

V_B = operating voltage; V_{Si} = control voltage; V_R = voltage on relay; t_v = delay time

Pulse lengthening time relay, with auxiliary voltage V_S on A1+ and A2- applied: relay stays in rest position; V_{Si} - pulse on St+; relay switches to working condition and switches off after t_v is over.

WSB marker cards

- Marking K; Item No.: 209-782
- Marking 1 ... 10; Item No.: 209-702
- Marking A1, A1, St, A2, A2, 12, 11, 11, 14; Item No.: 209-601

5 cards, each containing 10 strips with 10 markers

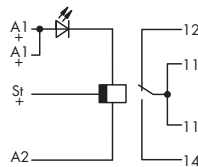

Description	Time range	Item No.	Pack. Unit
Time relay module	0.1 - 1 s	286-426	1
	1 - 10 s	286-427	1
	10 - 100 s	286-428	1

Technical Data

Accessories see pages 138 ... 139

Nominal input voltage (V_N)	24 V DC
Current input at rated voltage (coil 20 °C)	15.0 mA
Contact material	AgCdO, with gold flash
Max. switching voltage	250 V DC / 380 V AC
Max. make / break current	1 s 15 A / 5 A
Max. continuous current	5 A
Max. Switching power (resistive)	150 W / 2000 VA
Operating power	360 mW
Pull-in/drop-out/bounce time typ.	10 ms / 0 ms / 1 ms
Trigger voltage	24 V DC
Reset time	100 ms
Repeat accuracy	±0.5 %
Dielectric strength contact-coil (AC, 1 min)	3 kV
Nominal voltage acc. to VDE 0110 Part 1/4.97, IEC 60664-1	250 V / 4 kV / 3
Mechanical life	5 x 10 ⁷ switching operations
Mechanical life at max. load (resistance)	1 x 10 ⁵ switching operations
Ambient operating temperature	-25 °C ... +40 °C
Dimensions (mm) L x H x W incl. terminal block	20 x 82.5 x 50

Accessories

	Item No.	Pack. Unit
Terminal block for pluggable modules, with 2-conductor terminal blocks, orange separator ❶	22 mm / 0.866 in 280-638	1
with 4-conductor terminal blocks, orange separator ❷	22 mm / 0.866 in 280-628	1
with 4-conductor terminal blocks, marker plate ❸	25 mm / 0.984 in 280-764	1
wire range 0.08 mm ² ... 2.5 mm ² / AWG 28 ... 14; stripped length 8 ... 9 mm / 0.33 in		

	Off-delay timing with trigger voltage 1 changeover contact specified time acc. to IEC 255, part 1	Off-delay timing with trigger voltage 1 changeover contact specified time acc. to IEC 255, part 1
	Module width 20 mm / 0.787 in	Module width 20 mm / 0.787 in

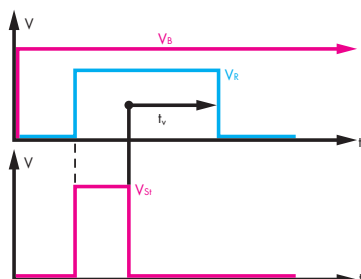

V_b = operating voltage; V_{st} = control voltage; V_r = voltage on relay; t_v = delay time

Off-delay time relay with auxiliary voltage
 V_b on A1+ and A2- applied: relay stays in rest position;
 V_{st} on St+ applied: relay switches to working condition
 V_{st} interrupted: t_v is activated; t_v is over: relay switches off
 WSB marker cards

- Marking K; Item No.: 209-782
- Marking 1 ... 10; Item No.: 209-702
- Marking A1, A1, St, A2, A2, 12, 11, 11, 14; Item No.: 209-601

5 cards, each containing 10 strips with 10 markers

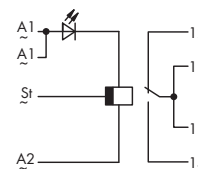
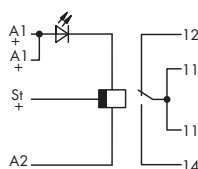

Description	Time range	Item No.	Pack. Unit	Time range	Item No.	Pack. Unit
Time relay module	0.1 - 1 s	286-440	1	0.1 - 1 s	286-446	1
	1 - 10 s	286-442	1	1 - 10 s	286-448	1
	10 - 100 s	286-444	1	10 - 100 s	286-450	1

Technical Data

Accessories see pages 138 ... 139

Accessories see pages 138 ... 139

Nominal input voltage (V_N)	24 V DC	230 V AC
Current input at rated voltage (coil 20 °C)	16.0 mA	16.8 mA
Contact material	Ag-Leg., with gold flash	Ag-Leg., with gold flash
Max. switching voltage	250 V DC / 250 V AC	250 V DC / 250 V AC
Max. make / break current	26 A / 5 A	26 A / 5 A
Max. continuous current	5 A	5 A
Max. Switching power (resistive)	100 W / 1250 VA	100 W / 1250 VA
Operating power	400 mW	3.7 VA
Pull-in/drop-out/bounce time typ.	15 ms / 0 ms / 2 ms	15 ms / 0 ms / 2 ms
Trigger voltage	24 V DC	230 V AC
Reset time	15 ms	15 ms
Repeat accuracy	±0.5 %	±0.5 %
Dielectric strength contact-coil (AC, 1 min)	2 kV	2 kV
Nominal voltage acc. to VDE 0110 Part 1/4.97, IEC 60664-1	250 V / 4 kV / 3	250 V / 2.5 kV / 3
Mechanical life	5 x 10 ⁷ switching operations	5 x 10 ⁷ switching operations
Mechanical life at max. load (resistance)	1 x 10 ⁵ switching operations	1 x 10 ⁵ switching operations
Ambient operating temperature	-25 °C ... +40 °C	-25 °C ... +40 °C
Dimensions (mm) L x H x W incl. terminal block	20 x 82.5 x 50	20 x 82.5 x 50

Accessories

	Item No.	Pack. Unit	Item No.	Pack. Unit
Terminal block for pluggable modules, with 2-conductor terminal blocks, orange separator ①	22 mm / 0.866 in 280-638	1	22 mm / 0.866 in 280-638	1
with 4-conductor terminal blocks, orange separator ②	22 mm / 0.866 in 280-628	1	22 mm / 0.866 in 280-628	1
with 4-conductor terminal blocks, marker plate ③	25 mm / 0.984 in 280-764	1	25 mm / 0.984 in 280-764	1
wire range 0.08 mm ² ... 2.5 mm ² / AWG 28 ... 14; stripped length 8 ... 9 mm / 0.33 in				

	<p>Pulse time delay relay 1 changeover contact specified time acc. to IEC 255, part 1</p> <p>Module width 20 mm / 0.787 in</p>	<p>Pulse time delay relay 1 changeover contact specified time acc. to IEC 255, part 1</p> <p>Module width 20 mm / 0.787 in</p>
--	--	--

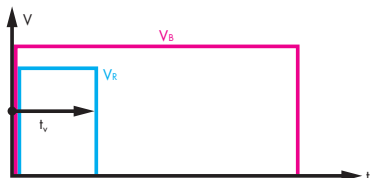

V_B = operating voltage; V_{Si} = control voltage; V_R = voltage on relay; t_v = delay time



Pulse time delay relay
 V_B on A1+ and A2- applied: relay switches to working condition;
 V_{Si} is over: relay switches off
 WSB marker cards
 • Marking K; Item No.: 209-782
 • Marking 1 ... 10; Item No.: 209-702
 • Marking A1, A1, A2, A2, 12, 11, 11, 14;
 Item No.: 209-996
 5 cards, each containing 10 strips with 10 markers

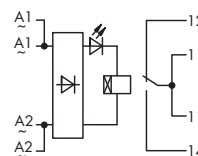
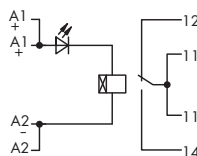

Description	Time range	Item No.	Pack. Unit	Time range	Item No.	Pack. Unit
Time relay module	0.1 - 1 s	286-460	1	0.1 - 1 s	286-470	1
	1 - 10 s	286-462	1	1 - 10 s	286-472	1
	10 - 100 s	286-464	1	10 - 100 s	286-474	1

Technical Data

Accessories see pages 138 ... 139

Accessories see pages 138 ... 139

Nominal input voltage (V_N)	24 V DC	230 V AC
Current input at rated voltage (coil 20 °C)	37.8 mA	39.7 mA
Contact material	AgCdO, with gold flash	AgCdO, with gold flash
Max. switching voltage	250 V DC / 380 V AC	250 V DC / 380 V AC
Max. make / break current	1 s 15 A / 5 A	1 s 15 A / 5 A
Max. continuous current	5 A	5 A
Max. Switching power (resistive)	150 W / 2000 VA	150 W / 2000 VA
Operating power	910 mW	10 VA
Pull-in/drop-out/bounce time typ.	15 ms / 15 ms / 1 ms	15 ms / 15 ms / 1 ms
Reset time	100 ms	100 ms
Repeat accuracy	±0.5 %	±0.5 %
Dielectric strength contact-coil (AC, 1 min)	2.3 kV	3 kV
Nominal voltage acc. to VDE 0110 Part 1/4.97, IEC 60664-1	250 V / 4 kV / 3	250 V / 2.5 kV / 3
Mechanical life	5 x 10 ⁷ switching operations	5 x 10 ⁷ switching operations
Mechanical life at max. load (resistance)	1 x 10 ⁵ switching operations	1 x 10 ⁵ switching operations
Ambient operating temperature	-25 °C ... +40 °C	-25 °C ... +40 °C
Dimensions (mm) L x H x W incl. terminal block	20 x 82.5 x 50	20 x 82.5 x 50

Accessories

	Item No.	Pack. Unit	Item No.	Pack. Unit
Terminal block for pluggable modules, with 2-conductor terminal blocks, orange separator ❶	22 mm / 0.866 in 280-638	1	22 mm / 0.866 in 280-638	1
with 4-conductor terminal blocks, orange separator ❷	22 mm / 0.866 in 280-628	1	22 mm / 0.866 in 280-628	1
with 4-conductor terminal blocks, marker plate ❸	25 mm / 0.984 in 280-764	1	25 mm / 0.984 in 280-764	1
Wire range 0.08 mm ² ... 2.5 mm ² / AWG 28 ... 14; stripped length 8 ... 9 mm / 0.33 in				

	Multirange timing relay, on-delay 4 selectable time ranges, 4 voltage ranges 1 changeover contact Module width 25 mm / 0.984 in	
--	--	--

Time range	03-3s	3-12s	10-100s	100-800s	Switch
Switch-position	OFF	ON	ON	OFF	1
	ON	OFF	ON	OFF	2

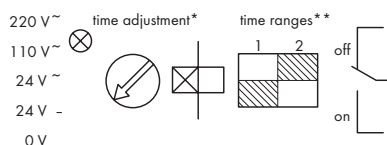

* with trimming potentiometer; ** DIL switch

Within these time ranges, time adjustment can be made with the timing potentiometer.

WSB marker cards

- Marking K; Item No.: 209-782
- Marking 1 ... 10; Item No.: 209-702
- Marking U1, U2, U3, U4, 0V, 12, 11, 11, 14, 14; Item No.: 209-951

5 cards, each containing 10 strips with 10 markers

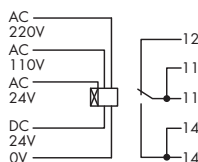

Description	Item No.	Pack. Unit
Multirange timing relay module; on-delay, 4 voltage ranges 230 V AC, 115 V AC, 24 V AC, 24 V DC; 0.3 s ... 3 s, 3 s ... 12 s, 10 s ... 100 s, 100 s ... 800 s Time ranges selectable with DIL switch	286-616	1

Technical Data

Accessories see pages 138 ... 139

Nominal input voltage (V_N)	230 V AC, 115 V AC, 24 V AC, 24 V DC
Current input at rated voltage (coil 20 °C)	30.4 mA, 32.6 mA, 20.2 mA, 17.5 mA
Contact material	AgNi with gold flash
Max. switching voltage	30 V DC / 240 V AC
Max. make / break current	5 A / 5 A
Max. continuous current	5 A
Max. Switching power (resistive)	120 W / 600 VA
Pull-in/drop-out/bounce time typ.	0 ms / 15 ms / 3 ms
Reset time	100 ms
Repeat accuracy	±0.5 %
Dielectric strength contact-coil (AC, 1 min)	2 kV
Nominal voltage acc. to VDE 0110 Part 1/4.97, IEC 60664-1	250 V / 4 kV / 3
Mechanical life	2×10^7 switching operations
Mechanical life at max. load (resistance)	1×10^5 switching operations
Ambient operating temperature	-25 °C ... +40 °C
Dimensions (mm) L x H x W incl. terminal block	25 x 82.5 x 50

Accessories

	Item No.	Pack. Unit	Item No.	Pack. Unit
Terminal block for pluggable modules, with 2-conductor terminal blocks, orange separator ①	27 mm / 1.063 in	280-639		1
with 4-conductor terminal blocks, orange separator ②	27 mm / 1.063 in	280-629		1
with 4-conductor terminal blocks, marker plate ③	30 mm / 1.181 in	280-765		1
wire range 0.08 mm² ... 2.5 mm² / AWG 28 ... 14; stripped length 8 ... 9 mm / 0.33 in				

	Multifunction timing relay 4 selectable time ranges, 4 functions 1 changeover contact Module width 20 mm / 0.787 in	
--	--	--

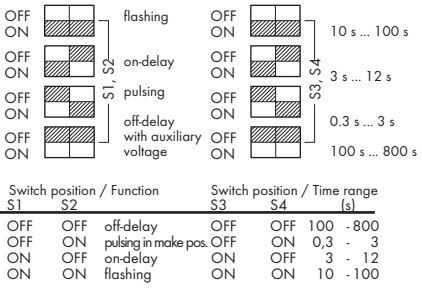

Fine adjustment of time within these time ranges can be made with the trimming potentiometer.
 St+ will only be connected for the function „off-delay“ with auxiliary voltage.
 WSB marker cards
 • Marking K; Item No.: 209-782
 • Marking 1 ... 10; Item No.: 209-702
 • Marking A1, A1, St, A2, A2, 12, 11, 11, 14; Item No.: 209-601
 5 cards, each containing 10 strips with 10 markers

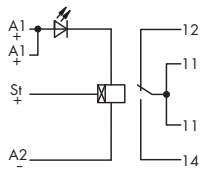

Description	Item No.	Pack. Unit
Multifunction timing relay module; on-delay, off-delay with auxiliary voltage, pulsing in make position, flashing; input voltage DC 24 V; 0.3 s ... 3 s, 3 s ... 12 s, 10 s ... 100 s, 100 s ... 800 s Function and timing range are selected with a DIL switch	286-640	1

Technical Data	Accessories see pages 138 ... 139	
Nominal input voltage (V _N)	24 V DC	
Current input at rated voltage (coil 20 °C)	24 mA	
Contact material	Ag-Leg., with gold flash	
Max. switching voltage	300 V DC / 440 V AC	
Max. make / break current	26 A / 5 A	
Max. continuous current	5 A	
Max. Switching power (resistive)	150 W / 1250 VA	
Pull-in/drop-out/bounce time typ.	0 ms / 0 ms / 2 ms	
Trigger voltage	24 V DC	
Reset time	100 ms	
Repeat accuracy	±1 %	
Dielectric strength contact-coil (AC, 1 min)	3 kV	
Nominal voltage acc. to VDE 0110 Part 1/4.97, IEC 60664-1	250 V / 4 kV / 3	
Mechanical life	1.5 x 10 ⁷ switching operations	
Mechanical life at max. load (resistance)	1 x 10 ⁵ switching operations	
Ambient operating temperature	-25 °C ... +40 °C	
Dimensions (mm) L x H x W incl. terminal block	20 x 82.5 x 50	

Accessories	Item No.	Pack. Unit
Terminal block for pluggable modules, with 2-conductor terminal blocks, orange separator ❶	22 mm / 0.866 in 280-638	1
with 4-conductor terminal blocks, orange separator ❷	22 mm / 0.866 in 280-628	1
with 4-conductor terminal blocks, marker plate ❸	25 mm / 0.984 in 280-764	1
wire range 0.08 mm² ... 2.5 mm² / AWG 28 ... 14; stripped length 8 ... 9 mm / 0.33 in		

	Optocoupler Input 24 V DC Output 5 V, 15 V, 24 V DC/500 mA Negative switching Module width 15 mm / 0.591 in	Optocoupler Input 24 V DC Output 5 V, 15 V, 24 V DC/500 mA Positive switching Module width 15 mm / 0.591 in
--	--	--

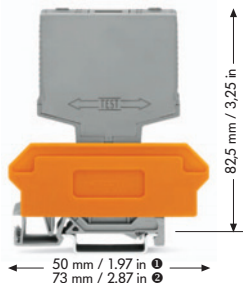

WSB marker cards

- Marking U; Item No.: 209-789
- Marking 1 ... 10; Item No.: 209-702
- Marking A1, A2, A2, 1, 3, 2, A1, A2, A2; Item No.: 209-685

5 cards, each containing 10 strips with 10 markers

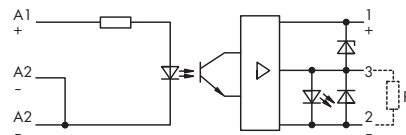
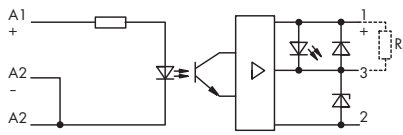

Description	Output	Item No.	Pack. Unit	Output	Item No.	Pack. Unit
Optocoupler module	5 V DC (3 V ... 6 V DC)	286-700	1	5 V DC (3 V ... 6 V DC)	286-750	1
	15 V DC (10 V ... 20 V DC)	286-701	1	15 V DC (10 V ... 20 V DC)	286-751	1
	24 V DC (20 V ... 30 V DC)	286-702	1	24 V DC (20 V ... 30 V DC)	286-752	1

Technical Data

Accessories see pages 138 ... 139

Accessories see pages 138 ... 139

Nominal input voltage (V_N)	24 V DC	24 V DC
Input voltage range	12 V ... 30 V DC	12 V ... 30 V DC
Input current range	5 mA ... 20 mA DC	5 mA ... 20 mA DC
Current at nominal voltage	15 mA DC	15 mA DC
Reverse voltage transistor / Triac	80 V DC	80 V DC
Max. permissible continuous current	500 mA	500 mA
Switch on / Switch off time	< 5 μ s / < 15 μ s	< 7 μ s / < 15 μ s
Max. operating frequency	25 kHz	25 kHz
Leakage current at nominal voltage	2.5 μ A	2.5 μ A
Collector / emitter voltage drop $V_{ce sat}$	≤ 1.2 V	≤ 1.2 V
Max. output (reverse current)	5 mA ; 10 mA ; 13 mA	5 mA ; 10 mA ; 12 mA
Test voltage input / output	2.5 kV eff.	2.5 kV eff.
Nominal voltage acc. to VDE 0110 Part 1/4.97, IEC 60664-1	250 V / 4 kV / 3	250 V / 4 kV / 3
Ambient operating temperature	-25 °C ... +40 °C	-25 °C ... +40 °C

Accessories

	Item No.	Pack. Unit	Item No.	Pack. Unit
Terminal block for pluggable modules, with 2-conductor terminal blocks, orange separator ①	17 mm / 0.669 in 280-619	1	17 mm / 0.669 in 280-619	1
with 4-conductor terminal blocks, orange separator ②	17 mm / 0.669 in 280-609	1	17 mm / 0.669 in 280-609	1
with 4-conductor terminal blocks, marker plate ③	20 mm / 0.787 in 280-763	1	20 mm / 0.787 in 280-763	1
wire range 0.08 mm² ... 2.5 mm² / AWG 28 ... 14; stripped length 8 ... 9 mm / 0.33 in				

	Optocoupler Input 230 V AC Output 5 V, 15 V, 24 V DC/500 mA Negative switching Module width 15 mm / 0.591 in	Optocoupler Input 230 V AC Output 5 V, 15 V, 24 V DC/500 mA Positive switching Module width 15 mm / 0.591 in
--	---	---

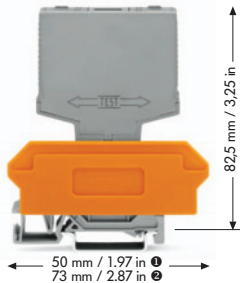

WSB marker cards

- Marking U; Item No.: 209-789
- Marking 1 ... 10; Item No.: 209-702
- Marking A1, A2, A2, 1, 3, 2, A1, A2, A2; Item No.: 209-685

5 cards, each containing 10 strips with 10 markers

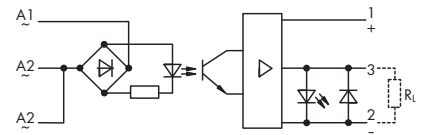
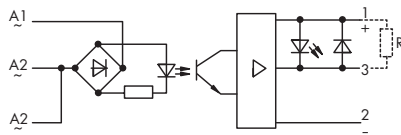

Description	Output	Item No.	Pack. Unit	Output	Item No.	Pack. Unit
Optocoupler module	5 V DC (3.5 V ... 7 V DC)	286-704	1	5 V DC (3.5 V ... 7 V DC)	286-754	1
	15 V DC (10 V ... 20 V DC)	286-706	1	15 V DC (10 V ... 20 V DC)	286-756	1
	24 V DC (20 V ... 30 V DC)	286-708	1	24 V DC (20 V ... 30 V DC)	286-758	1

Technical Data

Accessories see pages 138 ... 139

Accessories see pages 138 ... 139

Nominal input voltage (V _N)	230 V AC	230 V AC
Input voltage range	40 V ... 250 V AC	40 V ... 250 V AC
Input current range	0.2 mA ... 2.9 mA AC	0.2 mA ... 2.9 mA AC
Current at nominal voltage	2.6 mA AC	2.6 mA AC
Reverse voltage transistor / Triac	80 V DC	80 V DC
Max. permissible continuous current	500 mA	500 mA
Switch on / Switch off time	< 10 ms / < 50 ms	< 10 ms / < 40 ms
Leakage current at nominal voltage	2.5 µA	2.5 µA
Collector / emitter voltage drop V _{ce sat}	≤ 1.2 V	≤ 1.2 V
Max. output (reverse current)	5 mA ; 6 mA ; 5 mA	5 mA ; 7.5 mA ; 7.5 mA
Test voltage input / output	2.5 kV eff.	2.5 kV eff.
Nominal voltage acc. to VDE 0110 Part 1/4.97, IEC 60664-1	250 V / 4 kV / 3	250 V / 4 kV / 3
Ambient operating temperature	-25 °C ... +40 °C	-25 °C ... +40 °C

Accessories

	Item No.	Pack. Unit	Item No.	Pack. Unit
Terminal block for pluggable modules, with 2-conductor terminal blocks, orange separator ❶	17 mm / 0.669 in 280-619	1	17 mm / 0.669 in 280-619	1
with 4-conductor terminal blocks, orange separator ❷	17 mm / 0.669 in 280-609	1	17 mm / 0.669 in 280-609	1
with 4-conductor terminal blocks, marker plate ❸	20 mm / 0.787 in 280-763	1	20 mm / 0.787 in 280-763	1
wire range 0.08 mm ² ... 2.5 mm ² / AWG 28 ... 14; stripped length 8 ... 9 mm / 0.33 in				

1 Pluggable Modules - Optocouplers

	Optocoupler Input 24 V DC Output 24 V DC/2 A Negative switching Module width 15 mm / 0.591 in	Optocoupler Input 24 V DC Output 24 V DC/5 A Negative switching Module width 15 mm / 0.591 in
--	--	--

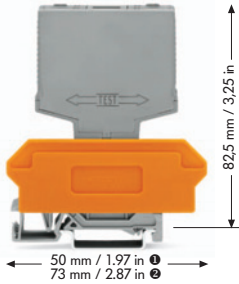

WSB marker cards

- Marking U; Item No.: 209-789
- Marking 1 ... 10; Item No.: 209-702
- Marking A1, A2, A2, 1, 3, 2, A1, A2, A2; Item No.: 209-685

5 cards, each containing 10 strips with 10 markers

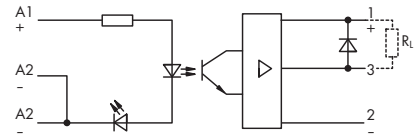
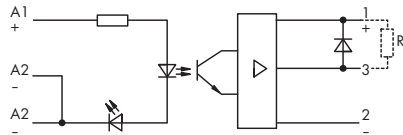

Description	Item No.	Pack. Unit	Item No.	Pack. Unit
Optocoupler module	286-720	1	286-721	1

Technical Data

Accessories see pages 138 ... 139

Accessories see pages 138 ... 139

Nominal input voltage (V _N)	24 V DC	24 V DC
Input voltage range	15 V ... 30 V DC	15 V ... 30 V DC
Input current range	7.5 mA ... 18 mA DC	7.5 mA ... 18 mA DC
Current at nominal voltage	13.5 mA DC	13.5 mA DC
Output nominal voltage	24 V DC	24 V DC
Output voltage range	15 V ... 40 V DC	15 V ... 40 V DC
Reverse voltage transistor / Triac	50 V DC	50 V DC
Max. permissible continuous current	2 A	5 A
Switch on / Switch off time	< 15 μs / < 40 μs	< 20 μs / < 80 μs
Max. operating frequency	1 kHz	1 kHz
Leakage current at nominal voltage	2.5 μA	2.5 μA
Collector / emitter voltage drop V _{ce sat}	≤ 0.5 V	≤ 0.5 V
Test voltage input / output	2.5 kV eff.	2.5 kV eff.
Nominal voltage acc. to VDE 0110 Part 1/4.97, IEC 60664-1	250 V / 4 kV / 3	250 V / 4 kV / 3
Ambient operating temperature	-25 °C ... +40 °C	-25 °C ... +40 °C

Accessories

	Item No.	Pack. Unit	Item No.	Pack. Unit
Terminal block for pluggable modules, with 2-conductor terminal blocks, orange separator ❶	17 mm / 0.669 in 280-619	1	17 mm / 0.669 in 280-619	1
with 4-conductor terminal blocks, orange separator ❷	17 mm / 0.669 in 280-609	1	17 mm / 0.669 in 280-609	1
with 4-conductor terminal blocks, marker plate ❸	20 mm / 0.787 in 280-763	1	20 mm / 0.787 in 280-763	1
wire range 0.08 mm ² ... 2.5 mm ² / AWG 28 ... 14; stripped length 8 ... 9 mm / 0.33 in				

	Optocoupler Input 5 V DC Output 24 V DC/500 mA Positive switching Module width 15 mm / 0.591 in	Optocoupler Input 24 V DC Output 24 V DC/4 A Positive switching Module width 15 mm / 0.591 in
--	--	--

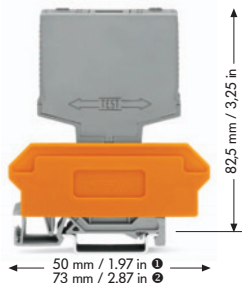

WSB marker cards

- Marking U; Item No.: 209-789
- Marking 1 ... 10; Item No.: 209-702
- Marking A1, A2, A2, 1, 3, 2, A1, A2, A2; Item No.: 209-685

5 cards, each containing 10 strips with 10 markers

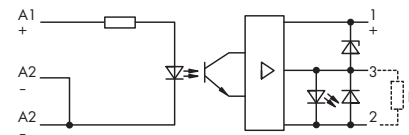
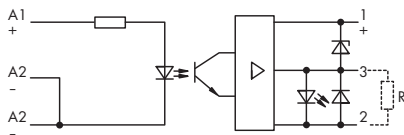

Description	Item No.	Pack. Unit	Item No.	Pack. Unit
Optocoupler module	286-752/002-000	1	286-723	1

Technical Data	Accessories see pages 138 ... 139	Accessories see pages 138 ... 139
Nominal input voltage (V _N)	5 V DC	24 V DC
Input voltage range	2 V ... 6.25 V DC	15 V ... 30 V DC
Input current range	3.3 mA ... > 18.5 mA	7.9 mA ... 18 mA DC
Current at nominal voltage	14 mA DC	14 mA DC
Output nominal voltage	24 V DC	24 V DC
Output voltage range	20 V ... 30 V DC	20 V ... 30 V DC
Reverse voltage transistor / Triac	80 V DC	100 V DC
Max. permissible continuous current	500 mA	4 A at 6 R
Switch on / Switch off time	< 5 μs / < 10 μs	≤ 15 μs / ≤ 25 μs
Max. operating frequency	25 kHz	5 kHz
Leakage current at nominal voltage	2.5 μA	2.5 μA
Collector / emitter voltage drop V _{ce sat}	≤ 1.2 V	≤ 1.2 V
Max. output (reverse current)	12 mA	12 mA
Test voltage input / output	2.5 kV eff.	2.5 kV eff.
Nominal voltage acc. to VDE 01 10 Part 1/4.97, IEC 60664-1	250 V / 4 kV / 3	250 V / 4 kV / 3
Ambient operating temperature	-25 °C ... +40 °C	-25 °C ... +40 °C
Approvals	IEC 60664 / IEC 60664A / DIN VDE 01 10; pollution degree 2; overvoltage category III	

Accessories	Item No.	Pack. Unit	Item No.	Pack. Unit
Terminal block for pluggable modules, w				
ith 2-conductor terminal blocks, orange separator ①	17 mm / 0.669 in 280-619	1	17 mm / 0.669 in 280-619	1
with 4-conductor terminal blocks, orange separator ②	17 mm / 0.669 in 280-609	1	17 mm / 0.669 in 280-609	1
with 4-conductor terminal blocks, marker plate ③	20 mm / 0.787 in 280-763	1	20 mm / 0.787 in 280-763	1
wire range 0.08 mm ² ... 2.5 mm ² / AWG 28 ... 14;				
stripped length 8 ... 9 mm / 0.33 in				

	Optocoupler Input 5 V DC 12 V DC 24 V DC Output 110 V DC/1.6 A Negative switching Module width 15 mm / 0.591 in	Optocoupler Input 5 V DC 12 V DC 24 V DC Output 230 V AC/50 mA ... 1 A Module width 15 mm / 0.591 in
--	--	---

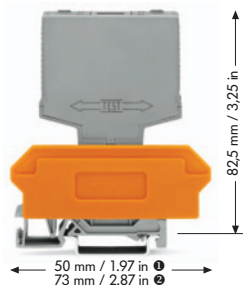

WSB marker cards

- Marking U; Item No.: 209-789
- Marking 1 ... 10; Item No.: 209-702
- Marking A1, A2, A2, 1, 3, 2, A1, A2, A2; Item No.: 209-685
- Marking A1, A2, A2, 1, 2, 2, A1, A2, A2; Item No.: 209-686

5 cards, each containing 10 strips with 10 markers

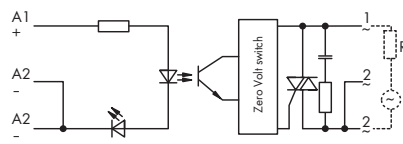
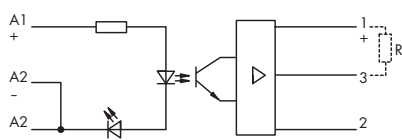

Description	Input	Item No.	Pack. Unit	Input	Item No.	Pack. Unit
Optocoupler module	5 V DC (4.5 V ... 6.5 V DC)	286-726	1	5 V DC (3.5 V ... 7.5 V DC)	286-732	1
	12 V DC (10 V ... 20 V DC)	286-728	1	12 V DC (9 V ... 18 V DC)	286-733	1
	24 V DC (15 V ... 30 V DC)	286-730	1	24 V DC (10 V ... 30 V DC)	286-734	1

Technical Data

Accessories see pages 138 ... 139

Accessories see pages 138 ... 139

Input current range	6.5 mA ... 20 mA DC 4 mA ... 12 mA DC 3.5 mA ... 8 mA DC	0.5 mA ... 17 mA DC 4 mA ... 11 mA DC 2 mA ... 8 mA DC
Current at nominal voltage	6.5 mA DC 6.4 mA DC 6.2 mA DC	6 mA DC
Output nominal voltage	110 V DC	230 V AC
Output voltage range	99 V ... 121 V DC	24 V ... 280 V AC
Reverse voltage transistor / Triac	150 V DC	600 V AC
Max. permissible continuous current	1.6 A at 69 R	1 A
Switch on / Switch off time	≤ 20 μs / ≤ 0.5 ms	1 half-wave ms / 1 half-wave ms
Max. operating frequency	350 Hz	
Leakage current at nominal voltage	3 μA	5 mA
Collector / emitter voltage drop V _{ce sat}	≤ 0.5 V	
Voltage drop at output		< 1.7 V AC
Test voltage input / output	2.5 kV eff.	2.5 kV eff.
Nominal voltage acc. to VDE 0110 Part 1/4.97, IEC 60664-1	250 V / 4 kV / 3	250 V / 4 kV / 3
Ambient operating temperature	-25 °C ... +40 °C	-25 °C ... +40 °C

Accessories

	Item No.	Pack. Unit	Item No.	Pack. Unit
Terminal block for pluggable modules, with 2-conductor terminal blocks, orange separator ①	17 mm / 0.669 in 280-619	1	17 mm / 0.669 in 280-619	1
with 4-conductor terminal blocks, orange separator ②	17 mm / 0.669 in 280-609	1	17 mm / 0.669 in 280-609	1
with 4-conductor terminal blocks, marker plate ③	20 mm / 0.787 in 280-763	1	20 mm / 0.787 in 280-763	1
wire range 0.08 mm² ... 2.5 mm² / AWG 28 ... 14; stripped length 8 ... 9 mm / 0.33 in				

	Optocoupler Input 10 V ... 30 V AC/DC Output 24 V DC/1 mA ... 0.5 A Negative switching Module width 15 mm / 0.591 in	Optocoupler Input 24 V DC Output 60 V DC/100 mA Module width 10 mm / 0.394 in
--	---	--

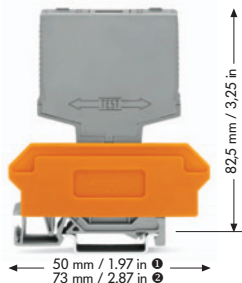

WSB marker cards

- Marking U; Item No.: 209-789
- Marking 1 ... 10; Item No.: 209-702
- Marking A1, A2, A2, 1, 3, 2, A1, A2, A2; Item No.: 209-685
- Marking A1, A2, A2, 1, 2, 2, A1, A2, A2; Item No.: 209-686

5 cards, each containing 10 strips with 10 markers

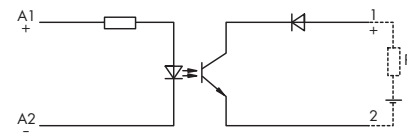
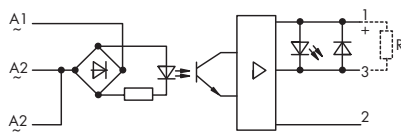

Description	Item No.	Pack. Unit	Item No.	Pack. Unit
Optocoupler module	286-725	1	286-791	1

Technical Data

Accessories see pages 138 ... 139

Accessories see pages 138 ... 139

Nominal input voltage (V _N)	10 V ... 30 V AC/DC	24 V DC
Input voltage range	10 V ... 30 V AC/DC	15 V ... 30 V DC
Input current range	2 mA ... 7 mA AC/DC	7.5 mA ... 18 mA DC
Current at nominal voltage		14 mA
Output nominal voltage	24 V DC	60 V DC
Output voltage range	20 V ... 30 V DC	20 V ... 60 V DC
Reverse voltage transistor / Triac	80 V DC	80 V DC
Max. permissible continuous current	500 mA	100 mA
Switch on / Switch off time	< 5 ms / < 30 ms	10 μs / 50 μs
Max. operating frequency		3 kHz
Leakage current at nominal voltage	max. 2.5 μA	2.5 μA
Collector / emitter voltage drop V _{ce sat}	≤ 1 V	
Max. output (reverse current)	6.5 mA ... 10 mA DC	
Voltage drop at output		≤ 2 V
Test voltage input / output	2.5 kV eff.	2.5 kV eff.
Nominal voltage acc. to VDE 0110 Part 1/4.97, IEC 60664-1	250 V / 4 kV / 3	250 V / 4 kV / 3
Ambient operating temperature	-25 °C ... +40 °C	-25 °C ... +40 °C

Accessories

Accessories	Item No.	Pack. Unit	Item No.	Pack. Unit
Terminal block for pluggable modules, with 2-conductor terminal blocks, orange separator ①	17 mm / 0.669 in 280-619	1	12 mm / 0.472 in 280-618	1
with 4-conductor terminal blocks, orange separator ②	17 mm / 0.669 in 280-609	1	12 mm / 0.472 in 280-608	1
with 4-conductor terminal blocks, marker plate ③	20 mm / 0.787 in 280-763	1	15 mm / 0.591 in 280-762	1
wire range 0.08 mm ² ... 2.5 mm ² / AWG 28 ... 14; stripped length 8 ... 9 mm / 0.33 in				

	Optocoupler Input 24 V DC Output 60 V DC/100 mA Module width 10 mm / 0.394 in	Dual channel optocoupler 2 inputs 2 x 24 V DC 2 outputs 2 x 24 V DC/2 x 250 mA Module width 20 mm / 0.787 in
--	--	---

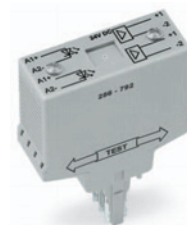
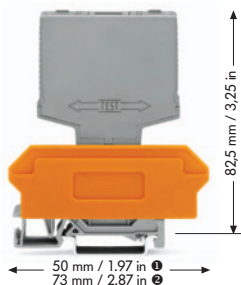

WSB marker cards

- Marking U; Item No.: 209-789
- Marking 1 ... 10; Item No.: 209-702
- Marking A1, A2, A2, 1, 2, 2, A1, A2, A2; Item No.: 209-686
- Marking A1+, A1+, A2-, A2-, 1, RL1, RL2, 2; Item No.: 209-955
- Marking A1+, A1+, A2-, A2-, 1+, 1+, A, 2-; Item No.: 249-651

5 cards, each containing 10 strips with 10 markers

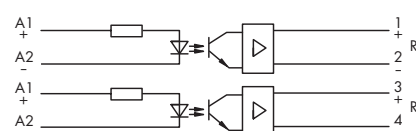
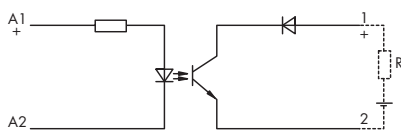

Description	Item No.	Pack. Unit	Item No.	Pack. Unit
Optocoupler module	286-794	1	286-792	1

Technical Data

Accessories see pages 138 ... 139

Accessories see pages 138 ... 139

Nominal input voltage (V _N)	24 V DC	24 V DC
Input voltage range	18 V ... 30 V DC	7.5 V ... 30 V DC
Input current range	2 mA ... 5 mA DC	4 mA ... 19 mA DC
Current at nominal voltage	4 mA DC	15 mA DC
Output nominal voltage	60 V DC	24 V DC
Output voltage range	20 V ... 60 V DC	20 V ... 30 V DC
Reverse voltage transistor / Triac	80 V DC	80 V DC
Max. permissible continuous current	100 mA	250 mA
Switch on / Switch off time	80 μs / 100 μs	< 60 μs / < 120 μs
Max. operating frequency	1.5 kHz	1.5 kHz
Leakage current at nominal voltage	2.5 μA	2.6 μA
Collector / emitter voltage drop V _{ce sat}		< 2.5 V
Voltage drop at output	≤ 2 V	
Test voltage input / output	2.5 kV eff.	2.5 kV eff.
Nominal voltage acc. to VDE 0110 Part 1/4.97, IEC 60664-1	250 V / 4 kV / 3	250 V / 4 kV / 3
Ambient operating temperature	-25 °C ... +60 °C	-25 °C ... +40 °C

Accessories

	Item No.	Pack. Unit	Item No.	Pack. Unit
Terminal block for pluggable modules, with 2-conductor terminal blocks, orange separator ①	12 mm / 0.472 in 280-618	1	22 mm / 0.866 in 280-638	1
with 4-conductor terminal blocks, orange separator ②	12 mm / 0.472 in 280-608	1	22 mm / 0.866 in 280-628	1
with 4-conductor terminal blocks, marker plate ③	15 mm / 0.591 in 280-762	1	25 mm / 0.984 in 280-764	1
wire range 0.08 mm² ... 2.5 mm² / AWG 28 ... 14; stripped length 8 ... 9 mm / 0.33 in				

	<p>Optocoupler with 2 inverted outputs Input 24 V DC Output 2 x 24 V DC/500 mA</p> <p>Module width 20 mm / 0.787 in</p>	<p>Optocoupler with bridge plug and programmable outputs Input 24 V DC Output 24 V DC, Short-circuit protected, positive switching Module width 20 mm/ 0.787 in</p>
--	---	--

286-938:

Optocoupler module with short-circuit protected, positive switching output.
 Two sockets with plug for programming the output.
 Independent of the input signal the output can be switched over to "H" (high) or "L" (low) by means of a bridge plug (supplied with the module).
 The short-circuit protected output is equipped with a current limiter which limits load currents above 800 mA to 200 mA.
 The maximum operating time of the current limiter is 60 s.
 Status indication:

- Input green LED
- Output yellow LED
- Short circuit red LED

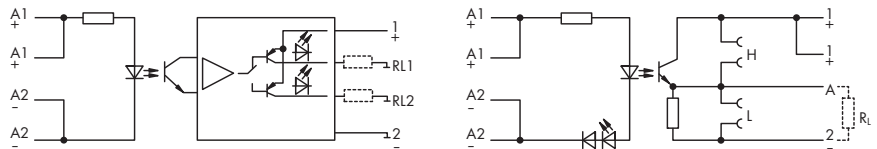
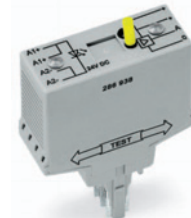
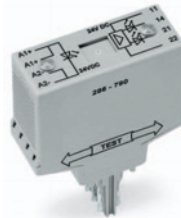

Description	Item No.	Pack. Unit	Item No.	Pack. Unit
Optocoupler module	286-790	1	286-938	1

Technical Data

Accessories see pages 138 ... 139

Accessories see pages 138 ... 139

Nominal input voltage (V _N)	24 V DC	24 V DC
Input voltage range	20 V ... 30 V DC	10 V ... 30 V DC
Input current range	7 mA ... 12 mA DC	4 mA ... 19 mA DC
Current at nominal voltage	9 mA DC	14 mA DC
Output nominal voltage	24 V DC	24 V DC
Output voltage range	20 V ... 30 V DC	20 V ... 30 V DC
Reverse voltage transistor / Triac	100 V DC	50 V DC
Max. permissible continuous current	500 mA	300 mA (800 mA max. 30 s)
Switch on / Switch off time	4 µs / 15 µs	< 5 µs / < 25 µs
Max. operating frequency	2.5 kHz	20 kHz at 80 R
Leakage current at nominal voltage	2.5 µA	< 1 µA
Collector / emitter voltage drop V _{ce sat}	< 1.2 V	< 1.1 V
Max. output (reverse current)		5.5 mA (Input high, output low); 3 mA (Input low, output low); 11 mA (Output high) programmed with bridge plug
Test voltage input / output	2.5 kV eff.	2.5 kV eff.
Nominal voltage acc. to VDE 0110 Part 1/4.97, IEC 60664-1	250 V / 4 kV / 3	250 V / 4 kV / 3
Ambient operating temperature	-25 °C ... +40 °C	-25 °C ... +40 °C

Accessories

Item No.

Pack. Unit

Item No.

Pack. Unit

Terminal block for pluggable modules, with 2-conductor terminal blocks, orange separator ①	22 mm / 0.866 in	280-638	1	22 mm / 0.866 in	280-638	1
with 4-conductor terminal blocks, orange separator ②	22 mm / 0.866 in	280-628	1	22 mm / 0.866 in	280-628	1
with 4-conductor terminal blocks, marker plate ③	25 mm / 0.984 in	280-764	1	25 mm / 0.984 in	280-764	1
wire range 0.08 mm ² ... 2.5 mm ² / AWG 28 ... 14; stripped length 8 ... 9 mm / 0.33 in						

	<p>Power optocoupler for S0 current meter interface with AC output</p> <p>Module width 20 mm / 0.787 in</p>	<p>Power optocoupler for S0 current meter interface with DC output</p> <p>Module width 20 mm / 0.787 in</p>
--	--	--



The optocoupler for the S0 current meter interface sends counter pulses from the supply lines.

Via this interface the user has the possibility to access data which is created by pulse generating current meters with a S0 current meter interface in accordance with DIN 43 864. The user can extract the data without affecting the S0 circuit and use them for their own evaluations, for example, optimizing energy consumption by reducing peak demands.

The optocoupler gets the input signal via a shunt resistance that is integrated in a terminal block for pluggable modules. Two parallel connected electrical contacts at the output allow reading of the S0 counter pulses. The optocoupler can be replaced without having to open the current meter circuit. When using passive metering systems, S0 power packs have to be added.

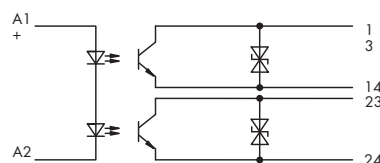
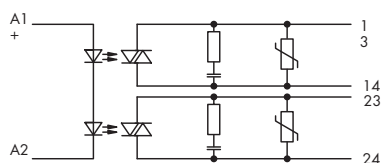

Description	Item No.	Pack. Unit	Item No.	Pack. Unit
S0 interface	286-740	1	286-741	1
Terminal block for pluggable modules, with shunt resistance	22 mm / 0.866 in wide	1	22 mm / 0.866 in wide	1

Technical Data	Accessories see pages 138 ... 139	Accessories see pages 138 ... 139
Input current I-Signal (H)	> 10 mA ... < 27 mA	> 10 mA ... < 27 mA
Input current O-Signal (L)	< 2 mA	< 2 mA
Switch-on treshold	> 8.5 mA	> 8.5 mA
Switch-off treshold	< 7 mA	< 7 mA
Transmission frequency		<100 Hz
Input wiring	reverse protection diode	reverse protection diode
Operating voltage range	24 V ... 280 V (50 Hz ... 60 Hz) AC	15 V ... 120 V DC
Peak reverse voltage	600 V AC	200 V DC
Continuous current	2 x 1 A	2 x 750 mA
Surge current t = 20 ms	60 A	3 A
Min. load current	30 mA	
Voltage drop at I max	< 1.2 V	< 1.2 V
Leakage current when turned off	< 2 mA	
Switch on / Switch off time	10 ms / 10 ms	5 ms / 3 ms
Output circuit	RC module / varistor	suppressor diode
Test voltage input / output	2.5 kV eff.	2.5 kV eff.
Wire connection	CAGE CLAMP®	CAGE CLAMP®
Ambient operating temperature	-25 °C ... +60 °C (at 0.4 A continuous current)	-25 °C ... +60 °C (at 200 mA continuous current)
Storage temperature	-40 °C ... +80 °C	-40 °C ... +80 °C
Approvals	DIN VDE 0110	DIN VDE 0110
Mounting position	any	any
Dimensions (mm) L x H x W incl. terminal block	20 x 82.5 x 73	20 x 82.5 x 73

Pluggable Modules - S0 Optocouplers

	Supply module for passive S0 current meter interface	
	Module width 25 mm / 0.984 in	

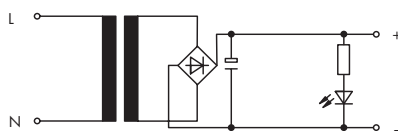
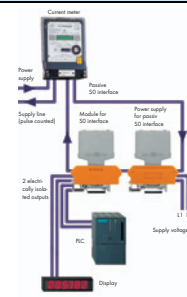

This compact module supplies power to passive S0 current meter interfaces.

Description	Item No.	Pack. Unit
S0 supply module	286-742	1
Technical Data		
Accessories see pages 138 ... 139		
Nominal input voltage (V_N)	230 V AC	
Frequency	50 Hz	
Max. output voltage DC (acc. to DIN 43 864)	27 V	
Max. output current (acc. to DIN 43 864)	27 mA	
Switch on / Switch off time		
Test voltage input / output	2.5 kV eff.	
Ambient operating temperature	0 °C ... +70 °C	
Storage temperature	-40 °C ... +80 °C	
Approvals	IEC 60664/ IEC 60664A/ DIN VDE 0110; IEC 60742/ EN 60742/ VDE 0551	
Mounting position	any	
Dimensions (mm) L x H x W incl. terminal block	25 x 82.5 x 73	
Accessories		
Terminal block for pluggable modules, with 4-conductor terminal blocks, orange separator	280-629	1
Wire range 0.08 mm² ... 2.5 mm² / AWG 28 ... 14; Stripped lengths 8 ... 9 mm / 0.33 in	27 mm / 1.063 in wide	
WSB marker card with marking: +/-	209-552	5

	<p>NAMUR switching amplifier with relay output (the switching amplifier has got an isolated output, e.g. for the connection of a PLC)</p> <p>Module width 20 mm / 0.787 in</p>	<p>NAMUR switching amplifier with relay output (the electronic output VA provides the status of the NAMUR sensor)</p> <p>Module width 20 mm / 0.787 in</p>
--	--	--

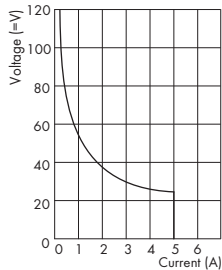

NAMUR switching amplifier for the supply of NAMUR sensors and the evaluation and amplification of the sensor signals in accordance with DIN 19234 and DIN 50 227. A line break or a sensor short circuit are monitored by the module and indicated via LEDs.

- LED 1 yellow: Line break
- LED 2 yellow: Short circuit
- LED 3 red: Output active

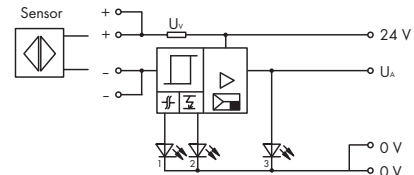
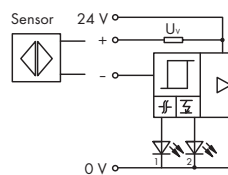

Description	Item No.	Pack. Unit	Item No.	Pack. Unit
NAMUR switching amplifier	286-880	1	286-881	1

Technical Data	Accessories see pages 138 ... 139	Accessories see pages 138 ... 139
Supply voltage V_B	24 V DC ($\pm 10\%$)	24 V DC ($\pm 10\%$)
Nominal input current	20 mA	20 mA
Input	2-wire NAMUR proximity sensor	2-wire NAMUR proximity sensor
Nominal voltage	8 V DC	8 V DC
Current limitation	8 mA	8 mA
Signal current (1)	≥ 2 mA	≥ 2 mA
Signal current (0)	≤ 1.7 mA	≤ 1.7 mA
Switching delay	10 ms	10 ms
Max. operating frequency		50 Hz
Short circuit monitoring	$I \geq 7$ mA	$I \geq 7$ mA
Line break monitoring	$I \leq 0.2$ mA	$I \leq 0.2$ mA
Output	relay 1 changeover contact	transistor
Contact material	AgNi 0.15	
Max. switching voltage	250 V AC / 120 V DC	24 V DC
Switching current	3 A	0.5 A
Output voltage VA		22 V $\pm 10\%$
Max. breaking capacity (resistive)	750 VA AC; DC see load limit curve	
Recommended minimum load	100 mA / 10 V AC/DC (1 W, 1VA)	
Pull-in/drop-out/bounce time typ.	8 ms / 5 ms / 4 ms	8 ms / 5 ms / 4 ms
Dielectric strength contact-coil (AC, 1 min)	4 kV	
Dielectric strength open contact	1 kV	
Nominal voltage acc. to VDE 0110 Part 1/4.97, IEC 60664-1	250 V / 4 kV / 3	
Mechanical life	1×10^8 switching operations	
Mechanical life at max. load (resistance)	3×10^5 switching operations	
Ambient operating temperature	-25 °C ... +40 °C	-25 °C ... +40 °C
Storage temperature	-40 °C ... +70 °C	-40 °C ... +70 °C
Approvals	DIN VDE 0160 and IEC 60255, DIN VDE 0435 (corresponding parts) DIN 19234, DIN 50227	DIN VDE 0160 and IEC 60255, DIN VDE 0435 (corresponding parts) DIN 19234, DIN 50227

Pluggable Modules - Switches

	1-pole changeover with changeover rocker switch Module width 15 mm / 0.591 in	1-pole changeover with momentary switch Module width 15 mm / 0.591 in
--	---	---

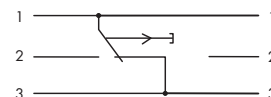
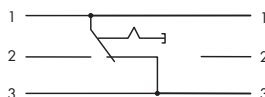
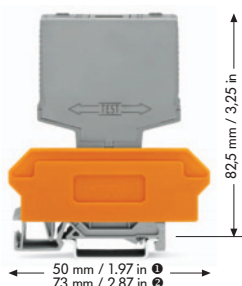

WSB marker card

- Marking S; Item No.: 209-682
- Marking 1 ... 10; Item No.: 209-702

5 cards, each containing 10 strips with 10 markers

Description	Item No.	Pack. Unit	Item No.	Pack. Unit
Switching module	286-895	1	286-896	1
Technical Data				
	Accessories see pages 138 ... 139		Accessories see pages 138 ... 139	
Max. switching voltage	24 V DC / 250 V AC		24 V DC / 250 V AC	
Switching current, resistive	6 A AC		6 A AC	
Switching current, inductive	4 A AC		4 A AC	
Electrical life	≥ 50.000 switching operations		≥ 50.000 switching operations	
Contact gap	≥ 3 mm		≥ 3 mm	
Isolation voltage	1250 V		1250 V	
Ambient operating temperature	-20 °C ... +40 °C		-20 °C ... +40 °C	
Approvals	Switch tested acc. to EN 61058-1		Switch tested acc. to EN 61058-1	
Accessories				
	Item No.	Pack. Unit	Item No.	Pack. Unit
Terminal block for pluggable modules, with 2-conductor terminal blocks, orange separator ①	17 mm / 0.669 in wide 280-619	1	17 mm / 0.669 in wide 280-619	1
with 4-conductor terminal blocks, orange separator ②	17 mm / 0.669 in wide 280-609	1	17 mm / 0.669 in wide 280-609	1
with 4-conductor terminal blocks, marker plate ③	20 mm / 0.787 in wide 280-763	1	20 mm / 0.787 in wide 280-763	1
wire range 0.08 mm ² ... 2.5 mm ² / AWG 28 ... 14; stripped length 8 ... 9 mm / 0.33 in				

1 Pluggable Modules - Current Flow Monitoring

128

	AC/DC current flow monitoring module 15 mA DC/35 mA ... 300 mA AC Module width 20 mm / 0.787 in	AC current flow monitoring module 80 mA ... 6 A Module width 20 mm / 0.787 in
--	--	--

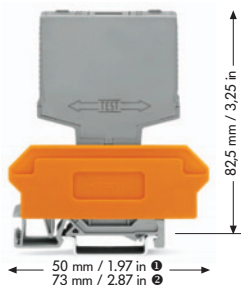

WSB marker card

- Marking U; Item No.: 209-789
- Marking 1 ... 10; Item No.: 209-702
- Marking Lin, Lin, Lout, Lout, 24V, UA, UA, 0V; Item No.: 209-957

5 cards, each containing 10 strips with 10 markers

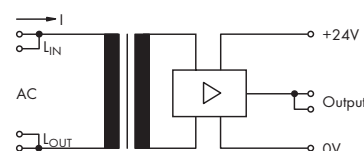
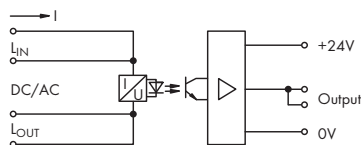

Description	Item No.	Pack. Unit	Item No.	Pack. Unit
Current flow monitoring module	286-659	1	286-661	1
Technical Data				
	Accessories see pages 138 ... 139		Accessories see pages 138 ... 139	
Current monitoring range	15 mA DC / 35 mA ... 300 mA AC Current < 15/35 mA Output 24 V DC Current > 15/35 mA Output 0 V		80 mA ... 6 A AC Current < 80 mA Output 24 V DC Current > 80 mA Output 0 V	
Voltage range	10 V ... 250 V AC/DC		5 V ... 250 V AC	
Nominal power consumption min / max	45 mW / 900 mW		1 mVA / 2.8 VA	
Voltage drop	3 V		13 mV ... 460 mV	
Response time	5 ms		40 ms	
Operating voltage	24 V DC		24 V DC	
Power consumption	61 mA		41 mA	
Switching current	50 mA		50 mA	
Switching voltage	24 V DC		24 V DC	
Switching power	1.2 W		1.2 W	
Dielectric strength input / output	2 kV		2 kV	
Nominal voltage acc. to VDE 0110 Part 1/4.97, IEC 60664-1	250 V / 4 kV / 3		250 V / 4 kV / 3	
Ambient operating temperature	-25 °C ... +40 °C		-25 °C ... +40 °C	
Status indication	Operation: LED = green output LOW, current interruption: LED = red output HIGH		Operation: LED = green output LOW, current interruption: LED = red output HIGH	
Accessories				
	Item No.	Pack. Unit	Item No.	Pack. Unit
Terminal block for pluggable modules, with 2-conductor terminal blocks, orange separator ①	22 mm / 0.866 in wide 280-638	1	22 mm / 0.866 in wide 280-638	1
with 4-conductor terminal blocks, orange separator ②	22 mm / 0.866 in wide 280-628	1	22 mm / 0.866 in wide 280-628	1
with 4-conductor terminal blocks, marker plate ③	25 mm / 0.984 in wide 280-764	1	25 mm / 0.984 in wide 280-764	1
wire range 0.08 mm ² ... 2.5 mm ² / AWG 28 ... 14; stripped length 8 ... 9 mm / 0.33 in				

	DC current flow monitoring module 0.4 A ... 3.5 A 1 make contact Module width 15 mm / 0.591 in	AC current flow monitoring module 0.2 A ... 3 A, adjustable (286-664) 1 A ... 10 A, adjustable (286-665) 1 changeover contact (1 u) Module width 25 mm / 0.984 in
--	---	--

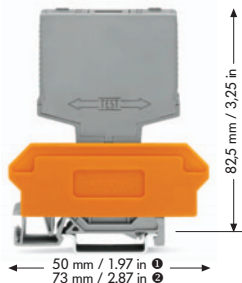

WSB marker card

- Marking U; Item No.: 209-789
- Marking 1 ... 10; Item No.: 209-702
- Marking Lin, Lin, Lout, 11, 14, 14, Lin, Lin, Lout; Item No.: 249-654
- Marking Lin, Lin, Lout, Lout, 24V, 11, 12, 14, 0V; Item No.: 209-997

5 cards, each containing 10 strips with 10 markers

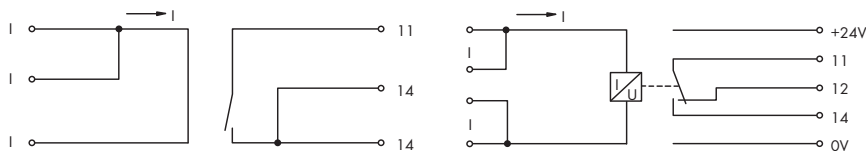

Description	Item No.	Pack. Unit	Item No.	Pack. Unit
Current flow monitoring module	286-662	1	286-664	1
			286-665	1

Technical Data

Accessories see pages 138 ... 139

Accessories see pages 138 ... 139

Current monitoring range	0.4 A ... 3.5 A DC (-20 °C ... +40 °C); 0.4 A ... 3 A DC (-20 °C ... +60 °C); 0.4 A ... 2 A DC (-20 °C ... +70 °C)	0.2 A ... 3 A AC (286-664) 1 A ... 10 A AC (286-665)
Voltage range	12 V ... 28 V DC	
Nominal power consumption min / max	45 mW / 630 mW	9 mVA / 1.3 VA (286-664) 23 mVA / 8.5 VA (286-665)
Switching threshold		min. 0.2 A (adjustable) (286-664) min. 1 A (adjustable) (286-665)
Turn on / off point	0.35 A / 0.07 A	
Voltage drop	24 mV ... 210 mV	44 mV ... 430 mV (286-664) 23 mV ... 850 mV (286-665)
Response time	0.5 ms	300 ms (286-664) 200 ms (286-665)
Output	1 make contact	1 changeover contact
Operating voltage		24 V DC
Power consumption		17 mA (286-664) 28 mA (286-665)
Switching current	0.5 A	5 A
Switching voltage	200 V DC	250 V AC
Switching power	10 W	1250 VA
Dielectric strength input / output	1.5 kV	2.5 kV
Nominal voltage acc. to VDE 0110 Part 1/4.97, IEC 60664-1		250 V / 4 kV / 3
Ambient operating temperature	-25 °C ... +40 °C	-25 °C ... +40 °C
Status indication		Current < switching threshold LED red, Relay switched

Accessories

Accessories	Item No.	Pack. Unit	Item No.	Pack. Unit
Terminal block for pluggable modules, with 2-conductor terminal blocks, orange separator ①	17 mm / 0.669 in wide 280-619	1	27 mm / 1.063 in wide 280-639	1
with 4-conductor terminal blocks, orange separator ②	17 mm / 0.669 in wide 280-609	1	27 mm / 1.063 in wide 280-629	1
with 4-conductor terminal blocks, marker plate ③	20 mm / 0.787 in wide 280-763	1	30 mm / 1.181 in wide 280-765	1
wire range 0.08 mm ² ... 2.5 mm ² / AWG 28 ... 14; stripped length 8 ... 9 mm / 0.33 in				

	Bridge with varistor protection for input voltage 24 V AC/1 A Module width 15 mm / 0.591 in	Bridge with varistor protection for input voltage 250 V AC/1 A Module width 15 mm / 0.591 in
--	--	---

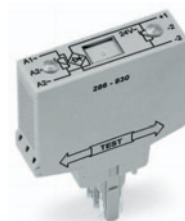
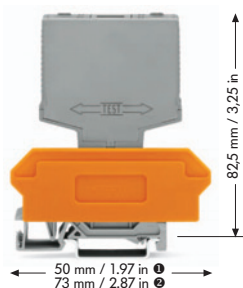

WSB marker card

- Marking V; Item No.: 209-784
- Marking 1 ... 10; Item No.: 209-702
- Marking +/-; Item No.: 209-652

5 cards, each containing 10 strips with 10 markers

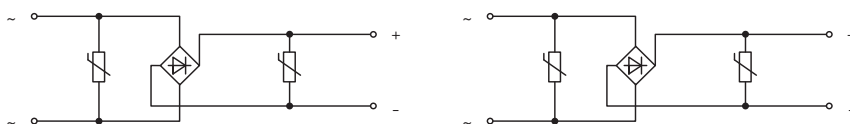

Description	Item No.	Pack. Unit	Item No.	Pack. Unit
Bridge rectifiers	286-830	1	286-840	1

Technical Data

Accessories see pages 138 ... 139

Accessories see pages 138 ... 139

Input voltage	24 V AC	250 V AC
Nominal current	1 A	1 A
Current pulse limit	10 A (10 ms)	10 A (10 ms)
Max. charging capacitor	2200 µF	500 µF
Max. nominal operating voltage input (Varistor)	35 V	250 V
Max. nominal operating voltage output (Varistor)	60 V	300 V
Ambient operating temperature	-25 °C ... +40 °C	-25 °C ... +40 °C

Accessories

Accessories	Item No.	Pack. Unit	Item No.	Pack. Unit
Terminal block for pluggable modules, with 2-conductor terminal blocks, orange separator ①	17 mm / 0.669 in wide 280-619	1	17 mm / 0.669 in wide 280-619	1
with 4-conductor terminal blocks, orange separator ②	17 mm / 0.669 in wide 280-609	1	17 mm / 0.669 in wide 280-609	1
with 4-conductor terminal blocks, marker plate ③	20 mm / 0.787 in wide 280-763	1	20 mm / 0.787 in wide 280-763	1
wire range 0.08 mm ² ... 2.5 mm ² / AWG 28 ... 14; stripped length 8 ... 9 mm / 0.33 in				

	<p>Fuse modules for replaceable microfuses 5 x 20 mm; max. 6.3 A with blown fuse indication LED green 24 V AC/DC</p> <p>Module width 10 mm / 0.394 in</p>	<p>Fuse modules for replaceable microfuses 5 x 20 mm; max. 6.3 A with blown fuse indication Neon lamp 230 V AC/DC</p> <p>Module width 10 mm / 0.394 in</p>
--	---	--

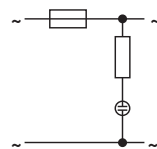
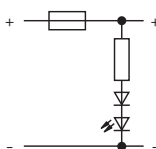
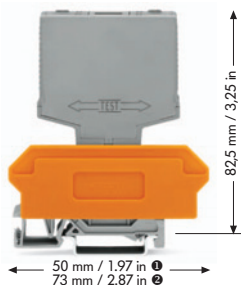

WSB marker card

- Marking F1 ... F10; Item No.: 209-787
- Marking 1 ... 10; Item No.: 209-702
- Marking +/-; Item No.: 209-652

5 cards, each containing 10 strips with 10 markers

Description	Item No.	Pack. Unit	Item No.	Pack. Unit
Fuse module, with blown fuse indication	286-890	1	286-891	1

Technical Data

Accessories see pages 138 ... 139

Accessories see pages 138 ... 139

Operating voltage	24 V AC/DC	230 V AC/DC
Max. fuse capacity	6.3 A	6.3 A
Operating power	100 mW	100 mW
Nominal voltage acc. to VDE 0110 Part 1/4.97, IEC 60664-1	250 V / 4 kV / 3	250 V / 4 kV / 3
Ambient operating temperature	-25 °C ... +40 °C	-25 °C ... +40 °C
Leakage current in case of blown fuse	5 mA	0.5 mA
Test voltage	2.5 kV	2.5 kV

Accessories

Accessories	Item No.	Pack. Unit	Item No.	Pack. Unit
Terminal block for pluggable modules, with 2-conductor terminal blocks, orange separator	12 mm / 0.472 in wide 280-618	1	12 mm / 0.472 in wide 280-618	1
with 4-conductor terminal blocks, orange separator	12 mm / 0.472 in wide 280-608	1	12 mm / 0.472 in wide 280-608	1
with 4-conductor terminal blocks, marker plate \otimes	15 mm / 0.591 in wide 280-762	1	15 mm / 0.591 in wide 280-762	1
wire range 0.08 mm ² ... 2.5 mm ² / AWG 28 ... 14; stripped length 8 ... 9 mm / 0.33 in				

Pluggable Modules - Diode Gates

	<p>Diode gate module with 3, 5, 7 or 9 diodes 1 N 4007, common anode</p> <p>Module width see Item No.</p>	<p>Diode gate module with 3, 5, 7 or 9 diodes 1 N 4007, common cathode</p> <p>Module width see Item No.</p>
--	--	--

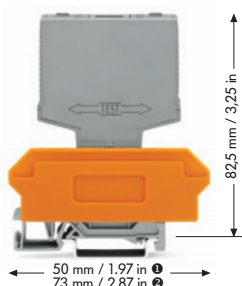

WSB marker card

- Marking V; Item No.: 209-784
- Marking 1 ... 10; Item No.: 209-702
- Marking +/-; Item No.: 209-652

5 cards, each containing 10 strips with 10 markers



Description	Module width	Item No.	Pack. Unit	Module width	Item No.	Pack. Unit
Diode gate module with 3 diodes	10 mm / 0.394 in	286-803	1	10 mm / 0.394 in	286-813	1
with 5 diodes	15 mm / 0.591 in	286-805	1	15 mm / 0.591 in	286-815	1
with 7 diodes	20 mm / 0.787 in	286-807	1	20 mm / 0.787 in	286-817	1
with 9 diodes	25 mm / 0.984 in	286-809	1	25 mm / 0.984 in	286-819	1

Technical Data

Accessories see pages 138 ... 139

Accessories see pages 138 ... 139

Operating voltage	250 V AC/DC	250 V AC/DC
Peak reverse voltage	1000 V	1000 V
Rectified current for each diode, resistive	1 A	1 A
Nominal voltage acc. to VDE 0110 Part 1/4.97, IEC 60664-1	250 V / 4 kV / 3	250 V / 4 kV / 3
Ambient operating temperature	-25 °C ... +40 °C	-25 °C ... +40 °C

Accessories

Accessories	Item No.	Pack. Unit	Item No.	Pack. Unit
Terminal block for pluggable modules, with 2-conductor terminal blocks, orange separator ①	12 mm / 0.472 in wide 280-618	1	12 mm / 0.472 in wide 280-618	1
with 4-conductor terminal blocks, orange separator ②	12 mm / 0.472 in wide 280-608	1	12 mm / 0.472 in wide 280-608	1
with 4-conductor terminal blocks, marker plate ③	15 mm / 0.591 in wide 280-762	1	15 mm / 0.591 in wide 280-762	1
Terminal block for pluggable modules, with 2-conductor terminal blocks, orange separator ①	17 mm / 0.669 in wide 280-619	1	17 mm / 0.669 in wide 280-619	1
with 4-conductor terminal blocks, orange separator ②	17 mm / 0.669 in wide 280-609	1	17 mm / 0.669 in wide 280-609	1
with 4-conductor terminal blocks, marker plate ③	20 mm / 0.787 in wide 280-763	1	20 mm / 0.787 in wide 280-763	1
Terminal block for pluggable modules, with 2-conductor terminal blocks, orange separator ①	22 mm / 0.866 in wide 280-638	1	22 mm / 0.866 in wide 280-638	1
with 4-conductor terminal blocks, orange separator ②	22 mm / 0.866 in wide 280-628	1	22 mm / 0.866 in wide 280-628	1
with 4-conductor terminal blocks, marker plate ③	25 mm / 0.984 in wide 280-764	1	25 mm / 0.984 in wide 280-764	1
Terminal block for pluggable modules, with 2-conductor terminal blocks, orange separator ①	27 mm / 1.063 in wide 280-639	1	27 mm / 1.063 in wide 280-639	1
with 4-conductor terminal blocks, orange separator ②	27 mm / 1.063 in wide 280-629	1	27 mm / 1.063 in wide 280-629	1
with 4-conductor terminal blocks, marker plate ③	30 mm / 1.181 in wide 280-765	1	30 mm / 1.181 in wide 280-765	1
wire range 0.08 mm ² ... 2.5 mm ² / AWG 28 ... 14; stripped length 8 ... 9 mm / 0.33 in				

1 Pluggable Modules - AND Gate and LED Indicator

	AND gate module with 6 inputs Relay output with 1 make contact Module width 25 mm / 0.984 in	LED indicator module with 8 LED, common cathode Module width 25 mm / 0.984 in
--	---	--

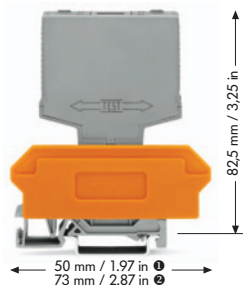

WSB marker card

- Marking D; Item No.: 209-783
- Marking 1 ... 10; Item No.: 209-702
- Marking +, -, 1, 2, 3, 13, 14, 4, 5, 6; Item No.: 249-608

5 cards, each containing 10 strips with 10 markers

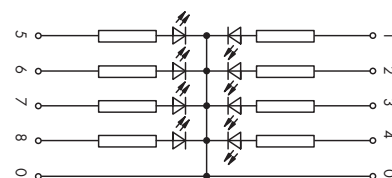
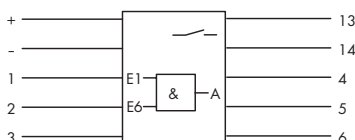

Description	Item No.	Pack. Unit	Item No.	Pack. Unit
Gate module	286-826	1	286-822	1

Technical Data

Accessories see pages 138 ... 139

Accessories see pages 138 ... 139

Operating voltage	24 V DC	24 V DC
Operating voltage range	24 V ... 27.5 V DC	20 V ... 26 V DC
Gate voltage - input	DC 24 V	
Power consumption at V _N	max. 34.6 mA	5.1 mA each LED
Relay output	make contact	
Max. switching voltage	250 V AC / 120 V DC	
Max. continuous current	3 A	
Max. Switching power (resistive)	120 W / 750 VA	
Dielectric strength input / output	2.5 kV	
Nominal voltage acc. to VDE 01 10 Part 1/4.97, IEC 60664-1	250 V / 4 kV / 3	
Ambient operating temperature	-25 °C ... +40 °C	-25 °C ... +40 °C

Accessories

Accessories	Item No.	Pack. Unit	Item No.	Pack. Unit
Terminal block for pluggable modules, with 2-conductor terminal blocks, orange separator ①	27 mm / 1.063 in wide 280-639	1	27 mm / 1.063 in wide 280-639	1
with 4-conductor terminal blocks, orange separator ②	27 mm / 1.063 in wide 280-629	1	27 mm / 1.063 in wide 280-629	1
with 4-conductor terminal blocks, marker plate ③	30 mm / 1.181 in wide 280-765	1	30 mm / 1.181 in wide 280-765	1
wire range 0.08 mm ² ... 2.5 mm ² / AWG 28 ... 14; stripped length 8 ... 9 mm / 0.33 in				

Pluggable Modules - Flip-Flop

	Flip-Flop Operating voltage 24 V DC Module width 15 mm / 0.591 in	
--	--	--

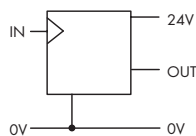
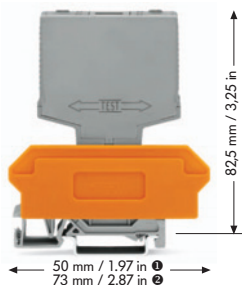

Description	Item No.	Pack. Unit	Item No.	Pack. Unit
Flip Flop module	286-825	1		
Technical Data				
Accessories see pages 138 ... 139				
Input voltage	24 V DC (± 10 %)			
Input current	0.25 mA			
Input voltage (High Signal)	> 7 V			
Input voltage (Low Signal)	< 3 V			
Pulse frequency	5 kHz			
Min. output voltage	V _B - 1.5 V			
Max. output current	0.5 A			
Operating voltage	24 V DC			
Operating voltage range	20 V ... 30 V DC			
Power consumption	7.5 mA			
Reverse voltage transistor	80 V			
Test voltage input/output	2.5 kV			
Nominal voltage acc. to VDE 0110 Part 1/4.97, IEC 60664-1	250 V / 4 kV / 3			
Ambient operating temperature	0 °C ... +55 °C			
Accessories				
Terminal block for pluggable modules, with 2-conductor terminal blocks, orange separator ①	17 mm / 0.669 in wide	280-619	1	
with 4-conductor terminal blocks, orange separator ②	17 mm / 0.669 in wide	280-609	1	
with 4-conductor terminal blocks, marker plate ③	20 mm / 0.787 in wide	280-763	1	
wire range 0.08 mm ² ... 2.5 mm ² / AWG 28 ... 14; stripped length 8 ... 9 mm / 0.33 in				

	Fault indicator module with reset Alarm with continuous light with outputs for visible and audible warning Auxiliary and fault indication voltage 230 V AC Module width 20 mm / 0.787 in	Fault indicator module with reset Alarm with continuous light with outputs for visible and audible warning Extensible to collective fault indicator by means of diode gates Auxiliary and fault indication voltage 60 V DC Module width 20 mm / 0.787 in
--	---	---



Explanation of signs

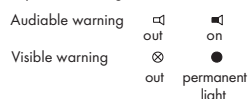

Accessories for collective fault indication (for 286-684)

- Diode gate 286-813 to 286-819, see page 442
- Diode gate 289-111 with common cathode, see page 504

WSB marker card

- Marking D; Item No.: 209-783
- Marking 1 ... 10; Item No.: 209-702
- Marking L, N, Quitt, Stör, A1, A2, Test, N, 14, 24; Item No.: 249-606

5 cards, each containing 10 strips with 10 markers

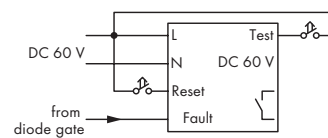
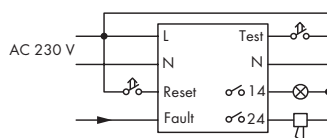

Description	Item No.	Pack. Unit	Item No.	Pack. Unit
Fault indicator module with reset	286-681	1	286-684	1

Technical Data

Accessories see pages 138 ... 139

Accessories see pages 138 ... 139

Nominal voltage	230 V AC	60 V DC / RW ≤ 6%
Tolerance	-10 % ... +5 %	± 10 %
Power consumption	15 mA	9 mA
Output for visible warning	230 V AC / 0.5 A	60 V DC / 0.5 A
Output for audible warning	230 V AC / 2 A	electrically isolated make contact
Max. switching voltage		250 V AC
Max. switching current		2 A
Max. switching capacity		500 VA
Nominal voltage acc. to VDE 0110 Part 1/4.97, IEC 60664-1	250 V / 4 kV / 3	250 V / 4 kV / 3
Ambient operating temperature	-25 °C ... +40 °C	-25 °C ... +40 °C

Accessories

	Item No.	Pack. Unit	Item No.	Pack. Unit		
Terminal block for pluggable modules, with 2-conductor terminal blocks, orange separator ❶	22 mm / 0.866 in wide	280-638	1	22 mm / 0.866 in wide	280-638	1
with 4-conductor terminal blocks, orange separator ❷	22 mm / 0.866 in wide	280-628	1	22 mm / 0.866 in wide	280-628	1
with 4-conductor terminal blocks, marker plate ❸	25 mm / 0.984 in wide	280-764	1	25 mm / 0.984 in wide	280-764	1
wire range 0.08 mm ² ... 2.5 mm ² / AWG 28 ... 14; stripped length 8 ... 9 mm / 0.33 in						

	Fault indicator module with reset Indication of original fault with single flashing light Output for audible warning Visible warning by LED Extensible to collective fault indicator by means of diode gates Module width 20 mm / 0.787 in	
--	---	--

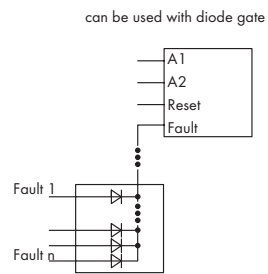
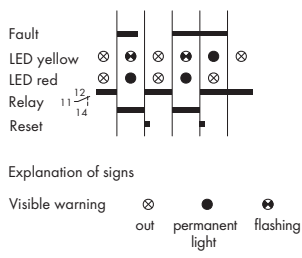

Accessories for collective fault indication

- Diode gate 286-813 to 286-819, see page 442
- Diode gate 289-111 with common cathode, see page 504

WSB marker card

- Marking D; Item No.: 209-783
- Marking 1 ... 10; Item No.: 209-702
- Marking A1, A2, Quitt, Stör, 12, 11, 11, 14; Item No.: 249-653

5 cards, each containing 10 strips with 10 markers

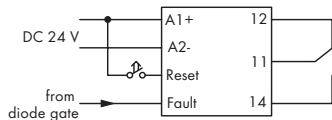

Description	Item No.	Pack. Unit
Fault indicator module with reset	286-683	1

Technical Data

Accessories see pages 138 ... 139

Nominal voltage	24 V DC / RW ≤ 6%
Tolerance	± 10 %
Power consumption	25 mA
Flashing frequency LED (yellow)	1 Hz
Relay output	1 electrically isolated changeover contact
Max. switching voltage	250 V AC / 120 V DC
Max. switching current	5 A
Max. switching capacity	120 W / 1250 VA
Contact material	AgNi 0.15
Dielectric strength contact-coil (AC, 1 min)	2.5 kV
Nominal voltage acc. to VDE 0110 Part 1/4.97, IEC 60664-1	250 V / 4 kV / 3
Ambient operating temperature	-25 °C ... +40 °C

Accessories

Item No.

Pack. Unit

Terminal block for pluggable modules, with 2-conductor terminal blocks, orange separator ①	22 mm / 0.866 in wide	280-638	1
with 4-conductor terminal blocks, orange separator ②	22 mm / 0.866 in wide	280-628	1
with 4-conductor terminal blocks, marker plate ③	25 mm / 0.984 in wide	280-764	1
wire range 0.08 mm ² ... 2.5 mm ² / AWG 28 ... 14; stripped length 8 ... 9 mm / 0.33 in			

Overview Pluggable Modules – Switching Relays

with an extended input voltage and operating temperature range V_N -30 % ... +25 % Ambient operating temperature -25 °C ... +70 °C

Switching relay module



Description	Nominal Input Voltage (V_N)	Input Voltage Range	Max. Switching Voltage	Module Width	Item No.	Pack. Unit
Switching relay module, Relay with 1 changeover contact	24 V DC	V_N -30 % ... +25 %	250 V AC/DC	15 mm / 0.591 in	286-304/004-000	1
Relay with 1 changeover contact	110 V DC	V_N -30 % ... +25 %	250 V AC/DC	15 mm / 0.591 in	286-307/004-000	1
Relay with 2 changeover contacts	24 V DC	V_N -30 % ... +25 %	250 V AC / 200 V DC	20 mm / 0.787 in	286-312/004-000	1
Relay with 1 break contact and 1 make contact	24 V DC	V_N -30 % ... +25 %	250 V AC / 200 V DC	20 mm / 0.787 in	286-320/004-000	1
Relay with 2 make contacts	24 V DC	V_N -30 % ... +25 %	250 V AC / 200 V DC	20 mm / 0.787 in	286-328/004-000	1
Relays with 2 make contacts and 2 make contacts	24 V DC	V_N -30 % ... +25 %	250 V AC / 200 V DC	25 mm / 0.984 in	286-336/001-000	1
Relay with 3 make contacts and 1 break contact	24 V DC	V_N -30 % ... +25 %	250 V AC / 200 V DC	25 mm / 0.984 in	286-344/004-000	1
Relay with 4 make contacts	24 V DC	V_N -30 % ... +25 %	250 V AC / 30 V DC	25 mm / 0.984 in	286-352/004-000	1
Relay with 1 make contact	24 V DC	V_N -30 % ... +25 %	250 V AC	10 mm / 0.394 in	286-364/004-000	1
Relay with 1 changeover contact	24 V DC	V_N -30 % ... +25 %	36 V DC	15 mm / 0.591 in	286-394/004-000	1
Time relay (on-delay timing) with 1 changeover contact	24 V DC	V_N -30 % ... +25 %	250 V AC / 200 V DC	20 mm / 0.787 in	286-604/004-000	1
Multifunction timing relay with 1 changeover contact	24 V DC	V_N -30 % ... +25 %	250 V AC / 120 V DC	20 mm / 0.787 in	286-640/004-000	1
Relay with 1 break contact and 1 make contact	24 V DC	V_N -30 % ... +25 %	250 V AC / 250 V DC	15 mm / 0.591 in	286-906/004-000	1

For additional technical data see: www.wago.com

2-conductor terminal block



4-conductor terminal block



Description	Item No.	Pack. Unit	
Terminal block for pluggable modules, with 2-conductor terminal blocks, orange separator	12 mm / 0.472 in wide	280-618	1
with 4-conductor terminal blocks, orange separator	12 mm / 0.472 in wide	280-608	1
with 4-conductor terminal blocks, marker plate	15 mm / 0.591 in wide	280-762	1
Terminal block for pluggable modules, with 2-conductor terminal blocks, orange separator	17 mm / 0.669 in wide	280-619	1
with 4-conductor terminal blocks, orange separator	17 mm / 0.669 in wide	280-609	1
with 4-conductor terminal blocks, marker plate	20 mm / 0.787 in wide	280-763	1
Terminal block for pluggable modules, with 2-conductor terminal blocks, orange separator	22 mm / 0.866 in wide	280-638	1
with 4-conductor terminal blocks, orange separator	22 mm / 0.866 in wide	280-628	1
with 4-conductor terminal blocks, marker plate	25 mm / 0.984 in wide	280-764	1
Terminal block for pluggable modules, with 2-conductor terminal blocks, orange separator	27 mm / 1.063 in wide	280-639	1
with 4-conductor terminal blocks, orange separator	27 mm / 1.063 in wide	280-629	1
with 4-conductor terminal blocks, marker plate	30 mm / 1.181 in wide	280-765	1
Terminal block for pluggable modules, with 4-conductor terminal blocks, orange separator	37 mm / 1.457 in wide	280-636	1

Wire range 0.08 mm² ... 2.5 mm² / AWG 28 ... 14; Stripped lengths 8 ... 9 mm / 0.33 in

WSB Marker Cards

Miniature quick marking card

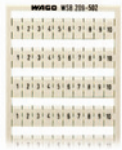

Description	Item No.	Pack. Unit
Marking: K	209-782	5 cards
1 ... 10 (10 x)	209-702	5 cards
A1, A2, 13, 14	209-952	5 cards
A1, A2, 11, 12	209-953	5 cards
11, 12, 14, A1, A2, A2, 11, 12, 14	209-994	5 cards
12, A1, A2, 24, 11, 14, 21, 22	209-995	5 cards
A1, A1, A2, A2, 11, 12, 13, 14, 23, 24	209-693	5 cards
12, A1, A2, 23, 24, 11, 13, 14, 21, 22	209-691	5 cards
12, A1, A2, 23, 24, 11, 13, 14, 33, 34	209-690	5 cards
14, A1, A2, 33, 34, 13, 23, 24, 43, 44	209-692	5 cards
A1, A2, 32, 31, 34, 42, 41, 12, 11, 14, 22, 21, 24, 44	249-656	5 cards
L+, 1, L-, L-, 11, 12, 13, 14	209-954	5 cards
A1, A2, A3, 11, 12, 14	249-607	5 cards
A1, A1, A2, A2, 12, 11, 11, 14	209-996	5 cards
A1, A1, St, A2, A2, 12, 11, 11, 14	209-601	5 cards
U1, U2, U3, U4, OV, 12, 11, 11, 14, 14	209-951	5 cards
U	209-789	5 cards
A1, A2, A2, 1, 3, 2	209-685	5 cards
A1, A2, A2, 1, 2, 2	209-686	5 cards
A1+, A1+, A2-, A2-, 1, RL1, RL2, 2	209-955	5 cards
A1+, A1+, A2-, A2-, 1+, 1+, A, 2-	249-651	5 cards
+/-	209-552	5 cards
1, 2, 3, OV, +UB, OUT, ERR., OV	249-622	5 cards
1, 2, OV, +UB, OUT, ERR., OV	249-623	5 cards
Lin, Lin, Lout, Lout, 24V, UA, UA, OV	209-957	5 cards
Lin, Lin, Lout, 11, 14, 14, Lin, Lin, Lout	249-654	5 cards
lin, lin, lout, lout, 24V, 11, 12, 14, OV	209-997	5 cards
S	209-682	5 cards
V	209-784	5 cards
F1 ... F10	209-787	5 cards
D	209-783	5 cards
+, -, 1, 2, 3, 13, 14, 4, 5, 6	249-608	5 cards
L, N, Quitt, Störung, Test, N, 14, 24	249-606	5 cards
A1, A2, Quitt, Störung, 12, 11, 11, 14	249-653	5 cards

5 cards, each containing 10 strips with 10 markers

Colored marker cards



Description	Item No.	Pack. Unit	
Marker cards and tags WSB 4 mm/0.157 in (plain)	white	209-701	5 cards
Marking software and printer/plotter see Section 8	yellow	209-701/000-002	5 cards
	red	209-701/000-005	5 cards
	blue	209-701/000-006	5 cards
	gray	209-701/000-007	5 cards
	orange	209-701/000-012	5 cards
	light green	209-701/000-017	5 cards
	green	209-701/000-023	5 cards
	violet	209-701/000-024	5 cards

5 cards, each containing 10 strips with 10 markers

	Relay with 1 changeover contact (1 u) Nominal input voltage V_N 24 V DC	Relay with 1 changeover contact (1 u) Nominal input voltage V_N 24 V DC, 230 V AC/DC
--	---	--

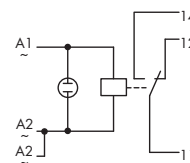
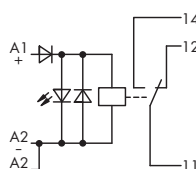
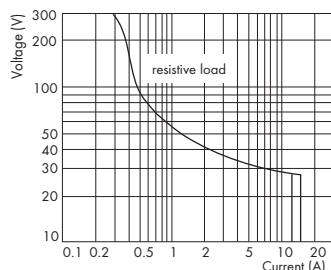

Other coil voltages contact factory

Description	V_N	I_N	Item No.	Pack. Unit	V_N	I_N	Item No.	Pack. Unit
Relay modules in DIN-rail mounted enclosure, for DIN 35 rail	24 V DC	19 mA	789-304	1	24 V AC/DC	20 mA	789-504	1
					230 V AC	4.2 mA	789-508	1

Technical Data	Accessories see page 146	
Contact material	AgNi 90/10	AgNi 90/10
Input voltage range	$V_N -15\% \dots +10\%$	$V_N -15\% \dots +10\%$
Max. switching voltage	250 V AC/DC	250 V AC/DC
Max. make current (resistive) at a 10 % duty cycle	4 s 25 A (AC)	4 s 25 A (AC)
Max. continuous current	12 A	12 A
Max. Switching power (resistive)	3000 VA AC, DC see load limit curve	3000 VA AC, DC see load limit curve
Recommended minimum load	> 100 mA / 12 V AC/DC	> 100 mA / 12 V AC/DC
Operating power	400 mW	0.96 VA
Pull-in/drop-out/bounce time typ.	7 ms / 3 ms / 3 ms	15 ms / 15 ms / 3 ms
Nominal operating mode	continuous duty	continuous duty
Dielectric strength contact-coil (AC, 1 min)	5 kV	5 kV
Dielectric strength open contact	1 kV	1 kV
Nominal voltage acc. to VDE 01 10 Part 1/4.97, IEC 60664-1	250 V / 4 kV / 3	250 V / 4 kV / 3
Mechanical life at 1000 W, AC 250 V	30×10^6 switching operations	30×10^6 switching operations
Service life at lamp load	1.2×10^3 switching operations	1.2×10^3 switching operations
Ambient operating temperature	-25 °C ... +40 °C	-25 °C ... +40 °C
Storage temperature	-40 °C ... +85 °C	-40 °C ... +85 °C
Dimensions (mm) W x H x L	17.5 x 55 x 90	17.5 x 55 x 90
Wire connection	Height from upper-edge of DIN 35 rail CAGE CLAMP®	Height from upper-edge of DIN 35 rail CAGE CLAMP®
Cross sections	0.08 mm ² ... 2.5 mm ² / AWG 28 ... 14	0.08 mm ² ... 2.5 mm ² / AWG 28 ... 14
Stripped lengths	5 ... 6 mm / 0.22 in	5 ... 6 mm / 0.22 in
Approvals	DIN VDE 0160 and IEC 60255; DIN VDE 0435 (corresp. parts)	DIN VDE 0160 and IEC 60255; DIN VDE 0435 (corresp. parts)

	Relay with 2 changeover contacts (2 u) Nominal input voltage V_N 24 V, 48 V, 110 V DC	Relay with 2 changeover contacts (2 u) Nominal input voltage V_N 24 V AC/DC, 115 V, 230 V AC
--	---	--

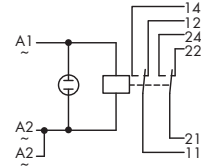
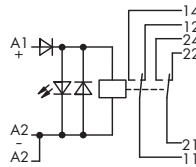
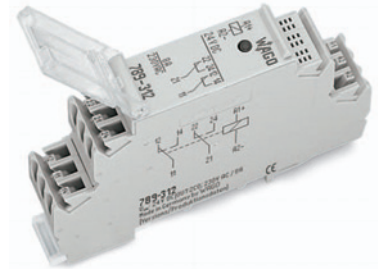
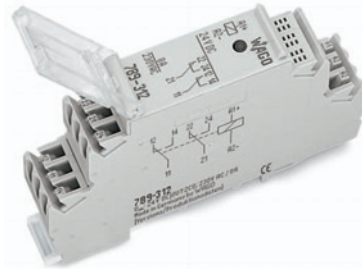
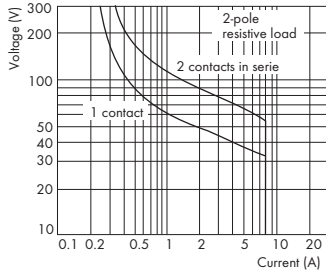

Other coil voltages contact factory

Description	V_N	I_N	Item No.	Pack. Unit	V_N	I_N	Item No.	Pack. Unit
Relay modules in DIN-rail mounted enclosure, for DIN 35 rail	24 V DC	21 mA	789-312	1	24 V AC/DC	22 mA	789-512	1
	48 V DC	13 mA	789-313	1	115 V AC	7.6 mA	789-515	1
	110 V DC	6 mA	789-315	1	230 V AC	4.2 mA	789-516	1

Technical Data

Accessories see page 146

Accessories see page 146

Contact material	AgNi 90/10	AgNi 90/10
Input voltage range	$V_N -15\% \dots +10\%$	$V_N -15\% \dots +10\%$
Max. switching voltage	250 V AC/DC	250 V AC/DC
Max. make current (resistive) at a 10 % duty cycle	4 s / 15 A	4 s / 15 A
Max. continuous current	8 A	8 A
Max. Switching power (resistive)	2000 VA AC, DC see load limit curve	2000 VA AC, DC see load limit curve
Recommended minimum load	> 100 mA / 12 V AC/DC	> 100 mA / 12 V AC/DC
Operating power	400 mW	0.96 VA
Pull-in/drop-out/bounce time typ.	7 ms / 2 ms / 3 ms	7 ms / 2 ms / 3 ms
Nominal operating mode	continuous duty	continuous duty
Dielectric strength contact-coil (AC, 1 min)	5 kV	5 kV
Dielectric strength open contact	1 kV	1 kV
Dielectric strength contact-contact	2.5 kV	1.5 kV
Nominal voltage acc. to VDE 0110 Part 1/4.97, IEC 60664-1	250 V / 4 kV / 3	250 V / 4 kV / 3
Mechanical life	3×10^7 switching operations	5×10^6 switching operation
Ambient operating temperature	-25 °C ... +40 °C	-25 °C ... +40 °C
Storage temperature	-40 °C ... +85 °C	-40 °C ... +85 °C
Dimensions (mm) W x H x L	17.5 x 55 x 90	17.5 x 55 x 90
Wire connection	Height from upper-edge of DIN 35 rail CAGE CLAMP®	Height from upper-edge of DIN 35 rail CAGE CLAMP®
Cross sections	0.08 mm ² ... 2.5 mm ² / AWG 28 ... 14	0.08 mm ² ... 2.5 mm ² / AWG 28 ... 14
Stripped lengths	5 ... 6 mm / 0.22 in	5 ... 6 mm / 0.22 in
Approvals	DIN VDE 0160 and IEC 60255; DIN VDE 0435 (corresp. parts)	DIN VDE 0160 and IEC 60255; DIN VDE 0435 (corresp. parts)

	Relay with 2 break and 2 make contacts (2 ar) Nominal input voltage V_N 24 V DC	Relay with 2 break and 2 make contacts (2 ar) Nominal input voltage V_N 12 V, 24 V AC/DC
--	---	--

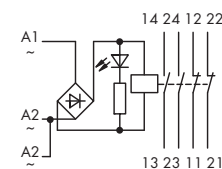
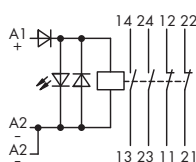
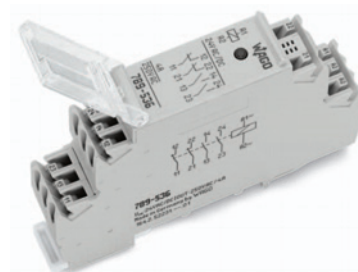
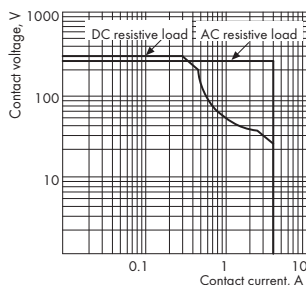

Note: Inductive loads have to be attenuated by an appropriate protective circuit in order to protect relay coils and contacts!

Description	V_N	I_N	Item No.	Pack. Unit	V_N	I_N	Item No.	Pack. Unit
Relay modules in DIN-rail mounted enclosure, for DIN 35 rail	24 V DC	12 mA	789-336	1	12 V AC/DC	21 mA	789-535	1
					24 V AC/DC	12 mA	789-536	1

Technical Data	Accessories see page 146	
Contact material	AuAg10 over AgNi 15	AuAg10 over AgNi 15
Input voltage range	$V_N -15\% \dots +10\%$	$V_N -15\% \dots +10\%$
Max. switching voltage	250 V AC / 30 V DC	250 V AC / 30 V DC
Max. switching current	4 A AC / 3 A DC	4 A AC / 3 A DC
Max. Switching power (resistive)	1000 VA / 90 W, resistive see load limit curve	1000 VA / 90 W, resistive see load limit curve
Recommended minimum load	$> 100 \mu\text{A} / 100 \text{ mV DC}$	$> 100 \mu\text{A} / 100 \text{ mV DC}$
Pull-in/drop-out/bounce time typ.	15 ms / 10 ms / 1 ms	20 ms / 20 ms / 1 ms
Nominal operating mode	continuous duty	continuous duty
Max. switching frequency with load	6 min^{-1}	6 min^{-1}
Dielectric strength contact-coil (AC, 1 min)	1.5 kV	1.5 kV
Dielectric strength open contact	0.75 kV	0.75 kV
Dielectric strength contact-contact	1 kV	1 kV
Nominal voltage acc. to VDE 01 10 Part 1/4.97, IEC 60664-1	230 V / 2.5 kV / 3	230 V / 2.5 kV / 3
Ambient operating temperature	$-25\text{ }^\circ\text{C} \dots +40\text{ }^\circ\text{C}$	$-25\text{ }^\circ\text{C} \dots +40\text{ }^\circ\text{C}$
Storage temperature	$-40\text{ }^\circ\text{C} \dots +85\text{ }^\circ\text{C}$	$-40\text{ }^\circ\text{C} \dots +85\text{ }^\circ\text{C}$
Dimensions (mm) W x H x L	17.5 x 55 x 90	17.5 x 55 x 90
Wire connection	Height from upper-edge of DIN 35 rail CAGE CLAMP®	Height from upper-edge of DIN 35 rail CAGE CLAMP®
Cross sections	0.08 mm ² ... 2.5 mm ² / AWG 28 ... 14	0.08 mm ² ... 2.5 mm ² / AWG 28 ... 14
Stripped lengths	5 ... 6 mm / 0.22 in	5 ... 6 mm / 0.22 in
Approvals	DIN VDE 01 10 Part1 / 4.97 IEC 60 664-1; DIN VDE 0435 (corresp. parts), EN 61 810	DIN VDE 01 10 Part1 / 4.97 IEC 60 664-1; DIN VDE 0435 (corresp. parts), EN 61 810

	Relay with 4 make contacts (4 a) Nominal input voltage V_N 24 V DC	Relay with 4 make contacts (4 a) Nominal input voltage V_N 12 V, 24 V AC/DC
--	--	---

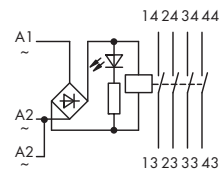
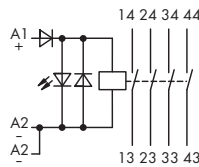
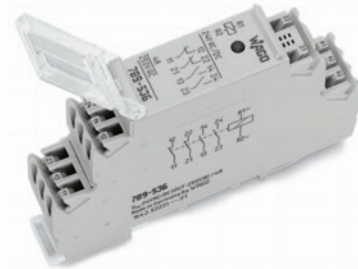
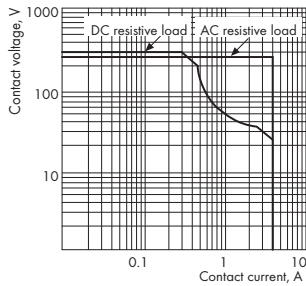

Description	V_N	I_N	Item No.	Pack. Unit	V_N	I_N	Item No.	Pack. Unit
Relay modules in DIN-rail mounted enclosure, for DIN 35 rail	24 V DC	12 mA	789-352	1	12 V AC/DC	21 mA	789-551	1
					24 V AC/DC	12 mA	789-552	1

Technical Data

Accessories see page 146

Accessories see page 146

Contact material	AuAg10 over AgNi 15	AuAg10 over AgNi 15
Input voltage range	$V_N -15\% \dots +10\%$	$V_N -15\% \dots +10\%$
Max. switching voltage	250 V AC / 30 V DC	250 V AC / 30 V DC
Max. switching current	4 A AC / 3 A DC	4 A AC / 3 A DC
Max. Switching power (resistive)	1000 VA / 90 W, resistive see load limit curve	1000 VA / 90 W, resistive see load limit curve
Recommended minimum load	$> 100 \mu\text{A} / 100 \text{ mV DC}$	$> 100 \mu\text{A} / 100 \text{ mV DC}$
Pull-in/drop-out/bounce time typ.	15 ms / 10 ms / 1 ms	20 ms / 20 ms / 1 ms
Nominal operating mode	continuous duty	continuous duty
Max. switching frequency with load	6 min^{-1}	6 min^{-1}
Dielectric strength contact-coil (AC, 1 min)	1.5 kV	1.5 kV
Dielectric strength open contact	0.75 kV	0.75 kV
Dielectric strength contact-contact	1 kV	1 kV
Nominal voltage acc. to VDE 0110 Part 1/4.97, IEC 60664-1	230 V / 2.5 kV / 3	230 V / 2.5 kV / 3
Ambient operating temperature	$-25 \text{ }^\circ\text{C} \dots +40 \text{ }^\circ\text{C}$	$-25 \text{ }^\circ\text{C} \dots +40 \text{ }^\circ\text{C}$
Storage temperature	$-40 \text{ }^\circ\text{C} \dots +85 \text{ }^\circ\text{C}$	$-40 \text{ }^\circ\text{C} \dots +85 \text{ }^\circ\text{C}$
Dimensions (mm) W x H x L	17.5 x 55 x 90	17.5 x 55 x 90
	Height from upper-edge of DIN 35 rail	Height from upper-edge of DIN 35 rail
Wire connection	CAGE CLAMP®	CAGE CLAMP®
Cross sections	0.08 mm ² ... 2.5 mm ² / AWG 28 ... 14	0.08 mm ² ... 2.5 mm ² / AWG 28 ... 14
Stripped lengths	5 ... 6 mm / 0.22 in	5 ... 6 mm / 0.22 in
Approvals	DIN VDE 0110 Part1 / 4.97 IEC 60 664-1; DIN VDE 0435 (corresp. parts), EN 61 810	DIN VDE 0110 Part1 / 4.97 IEC 60 664-1; DIN VDE 0435 (corresp. parts), EN 61 810

	Latching relay with 1 make contact (1 a) Nominal input voltage V_N 24 V DC	Latching relay with 1 make contact (1 a) Nominal input voltage V_N 230 V AC
--	--	---

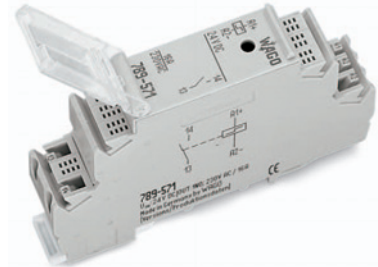
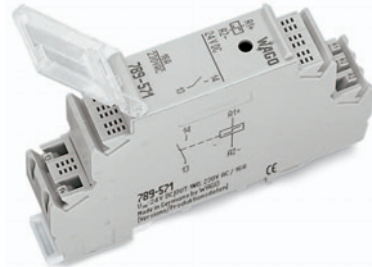
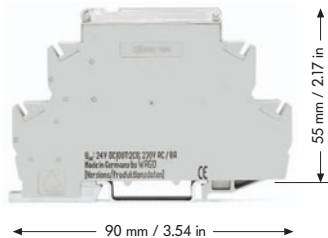

Lamp load: max. load 1500 W
Fluorescent lamp, dual circuit:
max. load 20 x 58 W series compensated
Electronic ballasts: 10 x 58 W

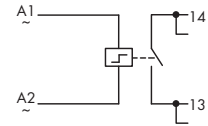
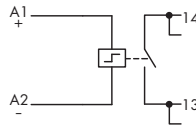

Description	V_N	I_N	Item No.	Pack. Unit	V_N	I_N	Item No.	Pack. Unit
Relay modules in DIN-rail mounted enclosure, for DIN 35 rail	24 V DC	42 mA	789-571	1	230 V AC	10 mA	789-570	1

Technical Data	Accessories see page 146	
Contact material	AgCdO	AgCdO
Input voltage range	$V_N -15\% \dots +10\%$	$V_N -15\% \dots +10\%$
Max. switching voltage	400 V AC	400 V AC
Min. switching current	0.1 A	0.1 A
Max. switching current	50 A (20 ms)	50 A (20 ms)
Max. continuous current	16 A	16 A
Max. Switching power (resistive)	4000 VA AC / 300 W DC	4000 VA AC / 300 W DC
Minimum switch-on time	40 ms	40 ms
Minimum break time	180 ms	180 ms
Coil control	Impuls	Impuls
Fuse protection	circuit breaker max. 16 A B-characteristic	circuit breaker max. 16 A B-characteristic
Nominal operating mode	continuous duty	continuous duty
Max. switching frequency with load	6 min ⁻¹	6 min ⁻¹
Max. switching frequency without load	4 s ⁻¹	4 s ⁻¹
Dielectric strength contact-coil (AC, 1 min)	4 kV	4 kV
Nominal voltage acc. to VDE 0110 Part 1/4.97, IEC 60664-1	250 V / 4 kV / 3	250 V / 4 kV / 3
Mechanical life	1 x 10 ⁵ switching operations	1 x 10 ⁵ switching operations
Mechanical life at max. load (resistance)	5 x 10 ⁴ switching operations	5 x 10 ⁴ switching operations
Ambient operating temperature	-25 °C ... +40 °C	-25 °C ... +40 °C
Storage temperature	-40 °C ... +85 °C	-40 °C ... +85 °C
Dimensions (mm) W x H x L	17.5 x 55 x 90	17.5 x 55 x 90
Wire connection	Height from upper-edge of DIN 35 rail CAGE CLAMP®	Height from upper-edge of DIN 35 rail CAGE CLAMP®
Cross sections	0.08 mm ² ... 2.5 mm ² / AWG 28 ... 14	0.08 mm ² ... 2.5 mm ² / AWG 28 ... 14
Stripped lengths	5 ... 6 mm / 0.22 in	5 ... 6 mm / 0.22 in
Approvals	DIN VDE 0160 and IEC 60255; DIN VDE 0435 (corresp. parts); DIN VDE 0632	DIN VDE 0160 and IEC 60255; DIN VDE 0435 (corresp. parts); DIN VDE 0632

	Relay with 1 make contact (1a), manual-0-automatic switch	Capability of different lamp loads: (switching operations acc. to EN 60669)
--	--	--

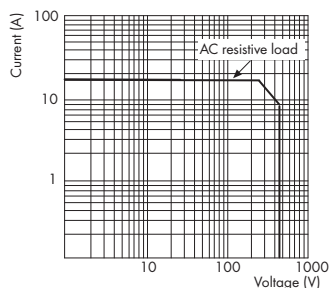

Type of load	Capability	Electrical life
Incandescent lamp	2200 W	20.000
Halogen lamp 230 V AC	1400 W	50.000
Halogen trafo	120 VA	20.000
Fluorescent lamp not comp., CB, cos φ 0,4-0,6	20 x 58 W	25.000
Fluorescent lamp comp., Conv. ballast, C parallel	9 x 58 W	25.000
Fluorescent lamp comp., Conv. ballast, Duo-circuit	600 W	20.000
Fluorescent lamp with electronic ballast	12 x 58 W	25.000
Energy saving lamp 15 W	25 pcs	20.000
Energy saving lamp 13 W	30 pcs	20.000
Energy saving lamp 9 W	38 pcs	20.000
Gas discharge lamp	1000 W	20.000
Dulux-Lamp not compensated	800 W	20.000
Dulux-Lamp compensated	500 W	20.000
Max. capacitance at 230 V AC	60 µF	min. 5.000

Note: Inductive loads have to be attenuated by an appropriate protective circuit in order to protect relay coils and contacts!

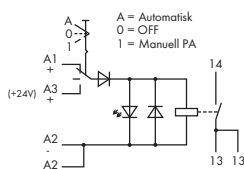

Description	V _N	Item No.	Pack. Unit
Relay modules in DIN-rail mounted enclosure, for DIN 35 rail	24 V DC	789-323	1

Technical Data

Accessories see page 146

Contact material	Ag-Legierung
Input voltage range	V _N -15 % ... +20 %
Current input at rated voltage (coil 20 °C)	19 mA
Max. switching voltage	250 V AC
Max. make current	120 A at 230 V AC (50 ms)
Max. continuous current	16 A
Max. Switching power (resistive)	4000 VA AC, resistance see load limit curve
Recommended minimum load	> 100 mA / 12 V AC/DC
Operating power	400 mW
Pull-in/drop-out/bounce time typ.	15 ms / 5 ms
Nominal operating mode	continuous duty
Dielectric strength contact-coil	4
Surge capacity open contact	1
Nominal voltage acc. to VDE 0110 Part 1/4.97, IEC 60664-1	250 V / 4 kV / 3
Mechanical life	10 x 10 ⁶ switching operations
Mechanical life at max. load (resistance)	min. 100.000 switching operations
Mechanical life at max. lamp load	see "Lamp loads" table
Ambient operating temperature	-25 °C ... +40 °C
Storage temperature	-40 °C ... +70 °C
Dimensions (mm) W x H x L	17,5 x 55 x 90
Wire connection	Height from upper-edge of DIN 35 rail CAGE CLAMP®
Cross sections	0.08 mm ² ... 2.5 mm ² / AWG 28 ... 14
Stripped lengths	5 ... 6 mm / 0.22 in
Approvals	DIN VDE 0140 part 1, DIN EN 61140; DIN VDE 0160, EN 50178; degree of protection II

Push-in type jumper bars



Commoning



Description		Item No.	Pack. Unit
Push-in type jumper bars	uninsulated, 12-way, to be cut to the required length	789-112	100 (4x25)

Operating tool



Wire connection



Marking pen with fibre tip



Description		Item No.	Pack. Unit
Marking pen	for permanent marking	210-110	1
Operating tool, with partially insulated shaft	Type 2, blade (3.5 x 0.5) mm	210-720	1

Miniature quick marking card



Marking

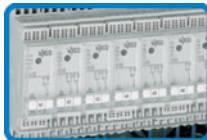

Description		Item No.	Pack. Unit
Miniature WSB Quick marking system	plain	248-501	5 cards
Marking software and printer/plotter see Section 8			
Marking	1 ... 10 (10 x)	248-502	5 cards
	11 ... 20 (10x)	248-503	5 cards
	21 ... 30 (10x)	248-504	5 cards
	31 ... 40 (10x)	248-505	5 cards
	41 ... 50 (10 x)	248-506	5 cards
	1 ... 50 (2 x)	248-566	5 cards
	K 1 ... K 10 (10 x)	248-450	5 cards
	K 11 ... K 20 (10 x)	248-451	5 cards
	K 100 (10 x)	248-452	5 cards
	U 1 ... U 10 (10 x)	248-453	5 cards
	U 11 ... U 20 (10 x)	248-454	5 cards
	U 100 (10 x)	248-455	5 cards
10 strips with 10 markers, white with black printing			

4-Channel EnOcean Radio Receivers in DIN-Rail Mount Enclosure

	4-channel EnOcean radio receiver with 4 changeover contacts, 8 A	4-channel EnOcean radio receiver with 4 make contacts, 16 A
--	---	--

The 4-channel radio receiver in DIN-rail mount enclosure is used to switch 4 independent electrical devices or loads. The radio receiver processes telegrams transmitted by sensors (binary information) using EnOcean radio technology (PTM + STM modules). The outputs are switched via relay contacts.



- Radio receiver for battery-less and wireless sensors
- LED indication of switch status
- External antenna for optimum transmission range (required)
- Frequency band 868 MHz
- Transmitter-to-receiver assignment via learn mode

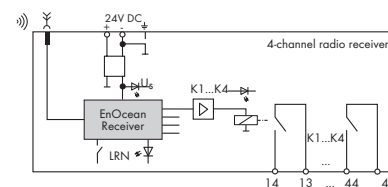
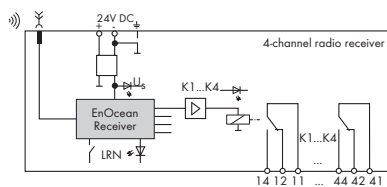

Description	Item No.	Pack. unit	Item No.	Pack. unit
4-channel EnOcean radio receiver	789-602	1	789-601	1

Technical Data

Voltage supply	24 V DC	24 V DC
Voltage range	-15 % ... + 20 %	-15 % ... + 20 %
Current consumption (internal)	max. 90 mA	max. 90 mA
Number of receive channels	40 (10 per output)	40 (10 per output)
Number of channels	4 (relay outputs)	4 (relay outputs)
Output current (per channel)	max. 8 A, AC1	max. 16 A, AC1
Type of load	resistive / motor load	resistive / lamp load
Switching frequency	max. < 5 Hz	max. < 5 Hz
Delay time transmitter /output command	< 100 ms; 40 ms ... 70 ms typ.	< 100 ms; 40 ms ... 70 ms typ.
Switching voltage	230 V AC	230 V AC
Fuse protection	Loads: wire breaker, max. 16 A	Loads: wire breaker, max. 16 A
Isolation	potential free contacts	potential free contacts
Ambient operating temperature	0 °C ... +55 °C	0 °C ... +55 °C
Storage temperature	-25 °C ... +85 °C	-25 °C ... +85 °C
Relative air humidity (no condensation)	85 %	85 %
Degree of pollution	2	2
Degree of protection	IP20	IP20
Mounting position	any	any
Dimensions (mm) W x H x L	70 x 55 x 90	70 x 55 x 90
Wire connection	Height from upper-edge of DIN 35 rail CAGE CLAMP® (WAGO 236 Series)	Height from upper-edge of DIN 35 rail CAGE CLAMP® (WAGO 236 Series)
Cross sections	0.08 mm² ... 2.5 mm² / AWG 28 ... 12 (THHN, THWN)	0.08 mm² ... 2.5 mm² / AWG 28 ... 12 (THHN, THWN)
Stripped lengths	5 ... 6 mm / 0.22 in	5 ... 6 mm / 0.22 in
Approvals	Vibration and shock resistance acc. to IEC 60068-2-6 and IEC 60068-2-27	Vibration and shock resistance acc. to IEC 60068-2-6 and IEC 60068-2-27
Accessories: RF magnetic antenna incl. 3m connecting cable with SMA connector	758-910	758-910

	Manual control module, digital, 4 outputs	Manual control module, analog, 4 outputs
--	---	--

The digital manual control module 789-810 controls the different outputs 0 ... 3 and indicates their status via green LEDs and the changeover contact of the power relay. Depending on both the manual/automatic switch and watchdog input, the states 0 or 1 are transmitted in an electrically isolated form to the output via a relay.



The analog manual control module 789-811 controls the different analog outputs 0 ... 3.

Depending on both the manual/automatic switch and watchdog input, the voltages set between 0 ... 10 V are transmitted to the output.

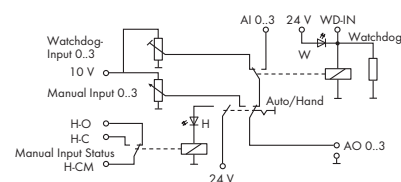
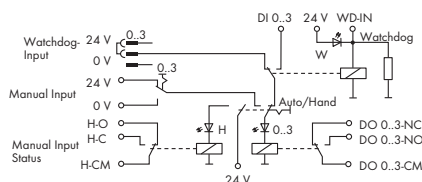

Description	Item No.	Pack. unit	Item No.	Pack. unit
Hand / Auto module	789-810	1	789-811	1

Technical Data

Technical Data	789-810	789-811
Voltage supply	24 V DC ± 20 %	24 V DC ± 20 %
Dielectric strength input / output	4 kV	
Ambient operating temperature	0 °C ... +50 °C	0 °C ... +50 °C
Storage temperature	-25 °C ... +70 °C	-25 °C ... +70 °C
Dimensions (mm) W x H x L	106 x 58 x 90	106 x 58 x 90
Wire connection	Height from upper-edge of DIN 35 rail CAGE CLAMP® (WAGO 734 and 231 Series)	Height from upper-edge of DIN 35 rail CAGE CLAMP® (WAGO 734 and 231 Series)
Cross sections	0.08 mm² ... 1.5 mm² / AWG 28 ... 14	0.08 mm² ... 1.5 mm² / AWG 28 ... 14
Stripped lengths	0.08 mm² ... 2.5 mm² / AWG 28 ... 12 7 mm / 0.28 in 8 ... 9 mm / 0.33 in	0.08 mm² ... 2.5 mm² / AWG 28 ... 12 7 mm / 0.28 in 8 ... 9 mm / 0.33 in
Approvals	VDE 0110 (corresponding parts)	VDE 0110 (corresponding parts)
Inputs		
No. 1/10	24 V Operating voltage supply	24 V Operating voltage supply
No. 2	GND ground	GND ground
No. 3 ... 6	DI-0 ... 3; Input 0 ... 3; 24 V/max. 20 mA	AI-0 ... 3; Input 0 ... 3; 0-10 V/max. 20 mA
No. 11	WD-IN; Watchdog input; 24 V/max. 20 mA	WD-IN; Watchdog input; 24 V/max. 20 mA
Outputs		
No. 7	H-C; Manual operation "closed"	H-C; Manual operation "closed"
No. 8	H-CM; Manual operation "common"	H-CM; Manual operation "common"
No. 9	H-O; Manual operation "open"	H-O; Manual operation "open"
No. 12/15/18/21	DO-0 ... 3-NC; Break contact; channel 0 ... 3	GND
No. 13/16/19/22	DO-0 ... 3-CM; Common; channel 0 ... 3	AO-0 ... 3; Output 0 ... 3; 0-10 V/max. 20 mA
No. 14/17/20/23	DO-0 ... 3-NO; Make contact; channel 0 ... 3	GND
Max. switching voltage channel nos. 12 ... 23	250 V AC / 30 V DC	
Max. switching current channel nos. 12 ... 23	8 A AC / 8 A DC	



WAGO Application: Traffic Control System in Canton of Tessin (Gotthard Route), Switzerland

WAGO Products:
 WAGO-I/O-SYSTEM (ETHERNET, CANopen),
 WAGO X-COM®-SYSTEM,
 MULTICONNECTION SYSTEM,
 TOPJOB®S Rail-Mounted Terminal Blocks

2

2



289 Series

Interface Modules with D-Subminiature Male and Female Connector

152 - 159



289 Series

Interface Modules for Ribbon Cable Connectors
Interface Module with High Density D-Sub Header for 19" Racks

160 - 165
166

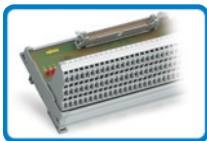

289, 704, 706 Series

Interface Modules for System Wiring
- Interface Modules for Siemes-SIMATIC
- Relay Output Module with Miniature Switching Relay
WAGO Ribbon Cables

168 - 171
172 - 178
179

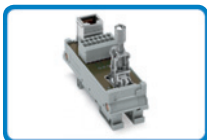

289 Series

RJ-45 Interface Modules

180 - 182

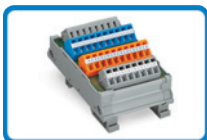

289 Series

Connection Modules for Sensors and Actuators

184 - 185



289 Series

Rail-Mounted Modules - Diode Gates
Rail-Mounted Modules - Resistor Gates

186 - 189
190



289 Series

Rail-Mounted Modules for Building Custom Circuits

191

	<p>Interface module with D-subminiature male connector, for mating connectors with solder connection, mating direction vertical</p> <p>Mounting carrier for DIN 35 rail</p>	<p>Interface module with D-subminiature male connector, for mating connectors with IDC, mating direction vertical</p> <p>Mounting carrier for DIN 35 rail</p>
--	---	---

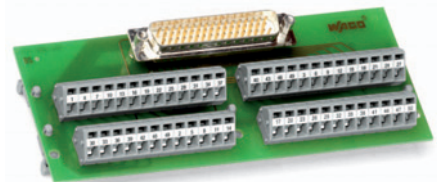
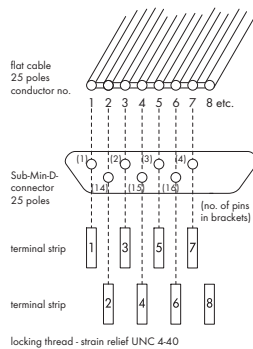

289-440 to 289-444

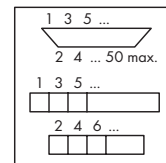
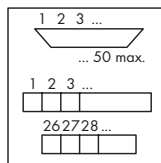

Description	No. of Poles	Width	Item No.	Pack. Unit	No. of Poles	Width	Item No.	Pack. Unit
Interface module	9	38	289-445	1	9	38	289-440	1
	15	53.5	289-446	1	15	53.5	289-441	1
	25	79	289-447	1	25	79	289-442	1
	37	120	289-448	1	37	120	289-443	1
	50	157	289-449	1	50	157	289-444	1

Technical Data

Operating voltage	125 V AC / DC	125 V AC / DC
Nominal current	1 A	1 A
Connector contact	plating, 0.5 µm ... 0.8 µm Au over 2 µm Ni	plating, 0.5 µm ... 0.8 µm Au over 2 µm Ni
Contact resistance	≤ 3 mΩ	≤ 3 mΩ
Performance level	2 / 200 mating cycles	2 / 200 mating cycles
Nominal voltage acc. to VDE 0110 Part 1/4.97, IEC 60664-1	50 V / 0.8 kV / 2	50 V / 0.8 kV / 2
Ambient operating temperature	-20 °C ... +50 °C	-20 °C ... +50 °C
Storage temperature	-40 °C ... +70 °C	-40 °C ... +70 °C
Dimensions (mm) W x H x L incl. mounting feet or mounting carrier	W x 19 x 63,5	W x 19 x 63,5
Wire connection	Height from upper-edge of DIN 35 rail CAGE CLAMP® (WAGO 236 Series)	Height from upper-edge of DIN 35 rail CAGE CLAMP® (WAGO 236 Series)
Cross sections	0.08 mm² ... 2.5 mm² / AWG 28 ... 12	0.08 mm² ... 2.5 mm² / AWG 28 ... 12
Stripped lengths	5 ... 6 mm / 0.22 in	5 ... 6 mm / 0.22 in

	<p>Interface module with D-subminiature male connector, for mating connectors with solder connection, mating direction vertical</p> <p>Mounting carrier for DIN 35 rail</p>	<p>Interface module with D-subminiature male connector, for mating connectors with IDC, mating direction vertical</p> <p>Mounting carrier for DIN 35 rail</p>
--	---	---

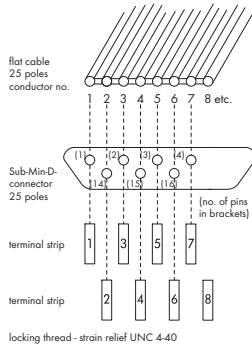

289-540 to 289-544

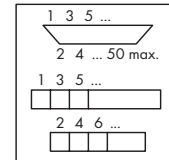
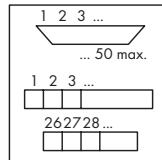

Description	No. of Poles	Width	Item No.	Pack. Unit	No. of Poles	Width	Item No.	Pack. Unit
Interface module	9	38	289-545	1	9	38	289-540	1
	15	46	289-546	1	15	46	289-541	1
	25	72	289-547	1	25	72	289-542	1
	37	102	289-548	1	37	102	289-543	1
	50	94	289-549	1	50	94	289-544	1

Technical Data

Operating voltage	125 V AC / DC	125 V AC / DC
Nominal current	2 A	2 A
Connector contact	plating, 0.5 µm ... 0.8 µm Au over 2 µm Ni	plating, 0.5 µm ... 0.8 µm Au over 2 µm Ni
Contact resistance	≤ 3 mΩ	≤ 3 mΩ
Performance level	2 / 200 mating cycles	2 / 200 mating cycles
Nominal voltage acc. to VDE 01 10 Part 1/4.97, IEC 60664-1	125 V / 0.8 kV / 2	125 V / 0.8 kV / 2
Ambient operating temperature	-20 °C ... +50 °C	-20 °C ... +50 °C
Storage temperature	-40 °C ... +70 °C	-40 °C ... +70 °C
Dimensions (mm) W x H x L incl. mounting feet or mounting carrier	W x 34 x 85	W x 34 x 85
Wire connection	Height from upper-edge of DIN 35 rail CAGE CLAMP® (WAGO 236 Series)	Height from upper-edge of DIN 35 rail CAGE CLAMP® (WAGO 236 Series)
Cross sections	0.08 mm² ... 2.5 mm² / AWG 28 ... 12	0.08 mm² ... 2.5 mm² / AWG 28 ... 12
Stripped lengths	5 ... 6 mm / 0.22 in	5 ... 6 mm / 0.22 in
Accessories		
WMB Multi marking system for mounting carrier	see page 323	see page 323
Marker strips for mounting carrier	white 709-198 / transparent 709-197	white 709-198 / transparent 709-197

	<p>Interface module with D-subminiature female connector, for mating connectors with solder connection, mating direction vertical</p> <p>Mounting carrier for DIN 35 rail</p>	<p>Interface module with D-subminiature female connector, for mating connectors with IDC, mating direction vertical</p> <p>Mounting carrier for DIN 35 rail</p>
--	---	---

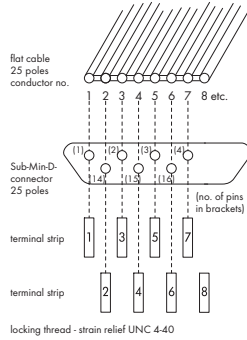

289-450 to 289-454

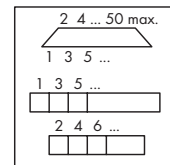
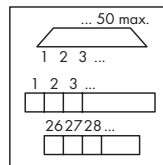

Description	No. of Poles	Width	Item No.	Pack. Unit	No. of Poles	Width	Item No.	Pack. Unit
Interface module	9	38	289-455	1	9	38	289-450	1
	15	53.5	289-456	1	15	53.5	289-451	1
	25	79	289-457	1	25	79	289-452	1
	37	120	289-458	1	37	120	289-453	1
	50	157	289-459	1	50	157	289-454	1

Technical Data

Operating voltage	125 V AC / DC	125 V AC / DC
Nominal current	1 A	1 A
Connector contact	plating, 0.5 µm ... 0.8 µm Au over 2 µm Ni	plating, 0.5 µm ... 0.8 µm Au over 2 µm Ni
Contact resistance	≤ 10 mΩ	≤ 10 mΩ
Performance level	2 / 200 mating cycles	2 / 200 mating cycles
Nominal voltage acc. to VDE 0110 Part 1/4.97, IEC 60664-1	50 V / 0.8 kV / 2	50 V / 0.8 kV / 2
Ambient operating temperature	-20 °C ... +50 °C	-20 °C ... +50 °C
Storage temperature	-40 °C ... +70 °C	-40 °C ... +70 °C
Dimensions (mm) W x H x L incl. mounting feet or mounting carrier	W x 19 x 63,5	W x 19 x 63,5
Wire connection	Height from upper-edge of DIN 35 rail CAGE CLAMP® (WAGO 236 Series)	Height from upper-edge of DIN 35 rail CAGE CLAMP® (WAGO 236 Series)
Cross sections	0.08 mm² ... 2.5 mm² / AWG 28 ... 12	0.08 mm² ... 2.5 mm² / AWG 28 ... 12
Stripped lengths	5 ... 6 mm / 0.22 in	5 ... 6 mm / 0.22 in

	Interface module with D-subminiature female connector, for mating connectors with solder connection, mating direction vertical Mounting carrier for DIN 35 rail	Interface module with D-Subminiature female connector, for mating connectors with IDC, mating direction vertical Mounting carrier for DIN 35 rail
--	--	--

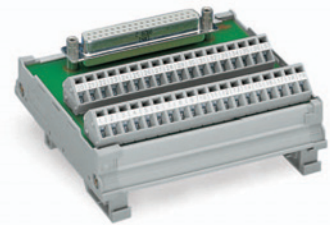
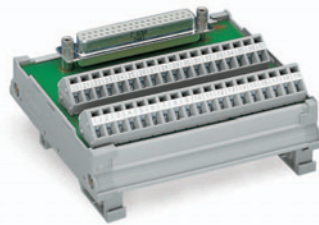
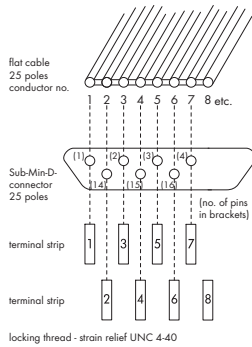

289-550 to 289-554

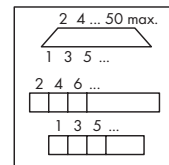
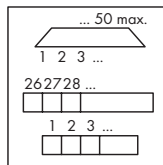

Description	No. of Poles	Width	Item No.	Pack. Unit	No. of Poles	Width	Item No.	Pack. Unit
Interface module	9	38	289-555	1	9	38	289-550	1
	15	46	289-556	1	15	46	289-551	1
	25	72	289-557	1	25	72	289-552	1
	37	102	289-558	1	37	102	289-553	1
	50	94	289-559	1	50	94	289-554	1

Technical Data

Operating voltage	125 V AC / DC	125 V AC / DC
Nominal current	2 A	2 A
Connector contact	plating, 0.5 µm ... 0.8 µm Au over 2 µm Ni	plating, 0.5 µm ... 0.8 µm Au over 2 µm Ni
Contact resistance	≤ 10 mΩ	≤ 10 mΩ
Performance level	2 / 200 mating cycles	2 / 200 mating cycles
Nominal voltage acc. to VDE 01 10 Part 1/4.97, IEC 60664-1	125 V / 0.8 kV / 2	125 V / 0.8 kV / 2
Ambient operating temperature	-20 °C ... +50 °C	-20 °C ... +50 °C
Storage temperature	-40 °C ... +70 °C	-40 °C ... +70 °C
Dimensions (mm) W x H x L incl. mounting feet or mounting carrier	W x 34 x 85	W x 34 x 85
Wire connection	Height from upper-edge of DIN 35 rail CAGE CLAMP® (WAGO 236 Series)	Height from upper-edge of DIN 35 rail CAGE CLAMP® (WAGO 236 Series)
Cross sections	0.08 mm² ... 2.5 mm² / AWG 28 ... 12	0.08 mm² ... 2.5 mm² / AWG 28 ... 12
Stripped lengths	5 ... 6 mm / 0.22 in	5 ... 6 mm / 0.22 in
Accessories		
WMB Multi marking system for mounting carrier	see page 323	see page 323
Marker strips for mounting carrier	white 709-198 / transparent 709-197	white 709-198 / transparent 709-197

	<p>Interface module with D-subminiature female connector, for mating connectors with solder connection, mating direction vertical, shield (screen) connection Mounting carrier for DIN 35 rail</p>	<p>Interface module with D-subminiature male connector, for mating connectors with solder connection, mating direction vertical, shield (screen) connection Mounting carrier for DIN 35 rail</p>
--	---	---

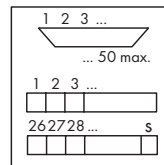
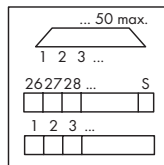

Description	No. of Poles	Width	Item No.	Pack. Unit	No. of Poles	Width	Item No.	Pack. Unit
Interface module	9	33	289-575	1	9	38.5	289-585	1
	15	43	289-576	1	15	46	289-586	1
	25	68.5	289-577	1	25	71.5	289-587	1
	37	99	289-578	1	37	102	289-588	1

Technical Data

Operating voltage	125 V AC / DC	125 V AC / DC
Nominal current	2 A	2 A
Connector contact	plating, 0.5 µm ... 0.8 µm Au over 2 µm Ni	plating, 0.5 µm ... 0.8 µm Au over 2 µm Ni
Contact resistance	≤ 10 mΩ	≤ 10 mΩ
Performance level	2 / 200 mating cycles	2 / 200 mating cycles
Nominal voltage acc. to VDE 01 10 Part 1/4.97, IEC 60664-1	125 V / 0.8 kV / 2	125 V / 0.8 kV / 2
Ambient operating temperature	-20 °C ... +50 °C	-20 °C ... +50 °C
Storage temperature	-40 °C ... +70 °C	-40 °C ... +70 °C
Dimensions (mm) W x H x L incl. mounting feet or mounting carrier	W x 34 x 85	W x 34 x 85
Wire connection	Height from upper-edge of DIN 35 rail CAGE CLAMP® (WAGO 236 Series)	Height from upper-edge of DIN 35 rail CAGE CLAMP® (WAGO 236 Series)
Cross sections	0.08 mm² ... 2.5 mm² / AWG 28 ... 12	0.08 mm² ... 2.5 mm² / AWG 28 ... 12
Stripped lengths	5 ... 6 mm / 0.22 in	5 ... 6 mm / 0.22 in
Accessories		
WMB Multi marking system for mounting carrier	see page 323	see page 323
Marker strips for mounting carrier	white 709-198 / transparent 709-197	white 709-198 / transparent 709-197

	<p>Interface module with D-subminiature female connector, for mating connectors with solder connection, mating direction vertical, shield (screen) connection Mounting carrier for DIN 35 rail</p>	<p>Interface module with D-subminiature male connector, for mating connectors with solder connection, mating direction vertical, shield (screen) connection Mounting carrier for DIN 35 rail</p>
--	---	---

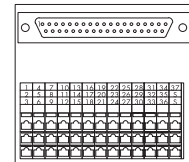
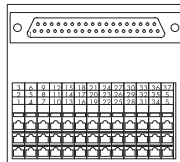

Description	No. of Poles	Width	Item No.	Pack. Unit	No. of Poles	Width	Item No.	Pack. Unit
Interface module	25	56	289-623	1	25	56	289-620	1
	37	74	289-624	1	37	74	289-621	1

Technical Data

Operating voltage	125 V AC / DC	125 V AC / DC
Nominal current	2 A	2 A
Connector contact	plating, 0.5 µm ... 0.8 µm Au over 2 µm Ni	plating, 0.5 µm ... 0.8 µm Au over 2 µm Ni
Contact resistance	≤ 10 mΩ	≤ 10 mΩ
Performance level	2 / 200 mating cycles	2 / 200 mating cycles
Nominal voltage acc. to VDE 01 10 Part 1/4.97, IEC 60664-1	125 V / 0.8 kV / 2	125 V / 0.8 kV / 2
Mounting direction	vertical	
Pull relief stud bolt	UNC 4-40	
Ambient operating temperature	-20 °C ... +55 °C	-20 °C ... +50 °C
Storage temperature	-40 °C ... +70 °C	-40 °C ... +70 °C
Dimensions (mm) W x H x L incl. mounting feet or mounting carrier	W x 62 x 85	W x 62 x 85
Wire connection	Height from upper-edge of DIN 35 rail CAGE CLAMP® (WAGO 737 Series)	Height from upper-edge of DIN 35 rail CAGE CLAMP® (WAGO 737 Series)
Cross sections	0.08 mm ² ... 2.5 mm ² / AWG 28 ... 12	0.08 mm ² ... 2.5 mm ² / AWG 28 ... 12
Stripped lengths	5 ... 6 mm / 0.22 in	5 ... 6 mm / 0.22 in
Accessories		
WMB Multi marking system for mounting carrier	see page 323	see page 323
Marker strips for mounting carrier	white 709-198 / transparent 709-197	white 709-198 / transparent 709-197

Interface module
with D-subminiature female connector
with shield (screen) connection

Mounting carrier for DIN 35 rail

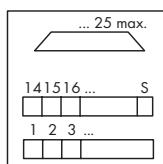
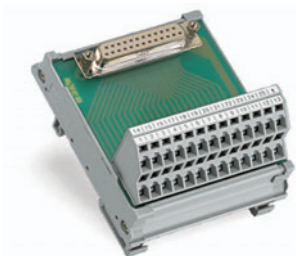

Description	No. of Poles	Width	Item No.	Pack. Unit
Interface module	9	33	289-650	1
	25	68.5	289-652	1

Technical Data

Operating voltage	125 V AC / DC
Nominal current	2 A
Connector contact	plating, 0.5 µm ... 0.8 µm Au over 2 µm Ni
Contact resistance	< 10 mΩ
Performance level	2 / 200 mating cycles
Nominal voltage acc. to VDE 0110 Part 1/4.97, IEC 60664-1	125 V / 0.8 kV / 2
Mounting direction	vertical
Pull relief stud bolt	UNC 4-40
Ambient operating temperature	-20 °C ... +50 °C
Storage temperature	-40 °C ... +70 °C
Dimensions (mm) W x H x L incl. mounting feet or mounting carrier	W x 48 x 85
Wire connection	Height from upper-edge of DIN 35 rail CAGE CLAMP® (WAGO 736 Series)
Cross sections	0.08 mm² ... 2.5 mm² / AWG 28 ... 12
Stripped lengths	5 ... 6 mm / 0.22 in
Accessories	
WMB Multi marking system for mounting carrier	see page 323
Marker strips for mounting carrier	white 709-198 / transparent 709-197

	<p>Interface module with D-subminiature male connector</p> <p>Mounting carrier for DIN 35 rail</p>	<p>Interface module with D-subminiature female connector</p> <p>Mounting carrier for DIN 35 rail</p>
--	--	--

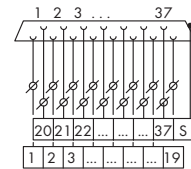
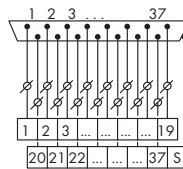

1 solder pin per pole is available for testing and patching (except for shield (screen) contact)

Description	No. of Poles	Width	Item No.	Pack. Unit	No. of Poles	Width	Item No.	Pack. Unit
Interface module	9	33.5	289-720	1	9	33.5	289-725	1
	15	43.5	289-721	1	15	43.5	289-726	1
	25	69	289-722	1	25	69	289-727	1
	37	99.5	289-723	1	37	99.5	289-728	1

Technical Data

Operating voltage	125 V AC / DC	125 V AC / DC
Nominal current	2 A	2 A
Connector contact	plating, 0.5 µm ... 0.8 µm Au over 2 µm Ni	plating, 0.5 µm ... 0.8 µm Au over 2 µm Ni
Contact resistance	≤ 10 mΩ	≤ 10 mΩ
Performance level	2 / 200 mating cycles	2 / 200 mating cycles
Nominal voltage acc. to VDE 01 10 Part 1/4.97, IEC 60664-1	125 V / 0.8 kV / 2	125 V / 0.8 kV / 2
Mounting direction	vertical	vertical
Pull relief stud bolt	UNC 4-40	UNC 4-40
Ambient operating temperature	-20 °C ... +50 °C	-20 °C ... +50 °C
Storage temperature	-40 °C ... +70 °C	-40 °C ... +70 °C
Dimensions (mm) W x H x L incl. mounting feet or mounting carrier	W x 48 x 85	W x 48 x 85
Wire connection	Height from upper-edge of DIN 35 rail CAGE CLAMP® (WAGO 736 Series)	Height from upper-edge of DIN 35 rail CAGE CLAMP® (WAGO 736 Series)
Cross sections	0.08 mm² ... 2.5 mm² / AWG 28 ... 12	0.08 mm² ... 2.5 mm² / AWG 28 ... 12
Stripped lengths	5 ... 6 mm / 0.22 in	5 ... 6 mm / 0.22 in
Accessories		
WMB Multi marking system for mounting carrier	see page 323	see page 323
Marker strips for mounting carrier	white 709-198 / transparent 709-197	white 709-198 / transparent 709-197

	Interface module for ribbon cable connectors acc. to DIN 41651 Mounting carrier for DIN 35 rail	Interface module for ribbon cable connectors acc. to DIN 41651 Mounting carrier for DIN 35 rail
--	--	--

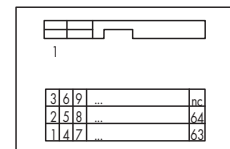
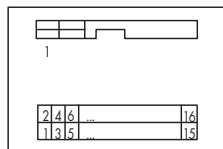
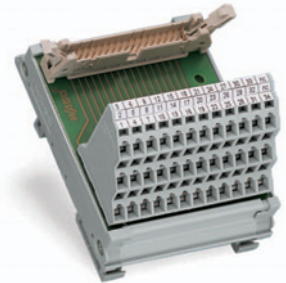

Description	No. of Poles	Width	Item No.	Pack. Unit	No. of Poles	Width	Item No.	Pack. Unit
Interface module	10	35	289-611	1	20	47	289-614	1
	14	40	289-612	1	26	55	289-615	1
	16	45	289-613	1	34	65	289-616	1
					40	74	289-617	1
					50	88	289-618	1
					64	114	289-619	1

Technical Data

Operating voltage	125 V AC / DC	125 V AC / DC
Nominal current	1 A	1 A
Connector contact	phosphor-bronze, 0.38 µm Au selectively over 1.3 µm Ni	phosphor-bronze, 0.38 µm Au selectively over 1.3 µm Ni
Performance level	3	3
Nominal voltage acc. to VDE 0110 Part 1/4.97, IEC 60664-1	125 V / 0.8 kV / 2	125 V / 0.8 kV / 2
Mounting direction	vertical	vertical
Ambient operating temperature	-20 °C ... +55 °C	-20 °C ... +55 °C
Storage temperature	-40 °C ... +70 °C	-40 °C ... +70 °C
Dimensions (mm) W x H x L incl. mounting feet or mounting carrier	W x 48 x 85	W x 62 x 85
Wire connection	Height from upper-edge of DIN 35 rail CAGE CLAMP® (WAGO 736 Series)	Height from upper-edge of DIN 35 rail CAGE CLAMP® (WAGO 737 Series)
Cross sections	0.08 mm² ... 2.5 mm² / AWG 28 ... 12	0.08 mm² ... 2.5 mm² / AWG 28 ... 12
Stripped lengths	5 ... 6 mm / 0.22 in	5 ... 6 mm / 0.22 in
Approvals	IEC 60603-1 / DIN 41651 Part 1 and 2	IEC 60603-1 / DIN 41651 Part 1 and 2
Accessories		
WMB Multi marking system for mounting carrier	see page 323	see page 323
Marker strips for mounting carrier	white 709-198 / transparent 709-197	white 709-198 / transparent 709-197

	<p>Interface module with header acc. to DIN 41 651</p> <p>Mounting carrier for DIN 35 rail</p>	<p>Interface module with header acc. to DIN 41 651</p> <p>Mounting carrier for DIN 35 rail</p>
--	--	--

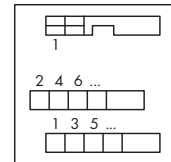
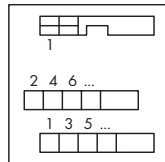
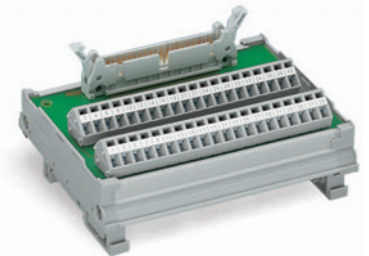
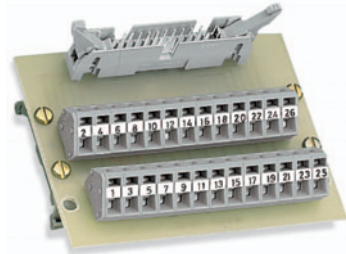

Description	No. of Poles	Width	Item No.	Pack. Unit	No. of Poles	Width	Item No.	Pack. Unit
Interface module	10	41	289-401	1	10	38	289-501	1
	14	51.5	289-402	1	14	43	289-502	1
	16	56.5	289-403	1	16	46	289-503	1
	20	66.5	289-404	1	20	53.5	289-504	1
	26	81	289-405	1	26	71	289-505	1
	34	102	289-406	1	34	94	289-506	1
	40	126	289-407	1	40	114	289-507	1
	50	151	289-408	1	50	132	289-508	1
	64	187	289-409	1	64	170	289-509	1
					64	120	289-510	1

Technical Data

Operating voltage	125 V AC / DC	125 V AC / DC
Nominal current	1 A	1 A
Connector contact	phosphor-bronze, 0.38 µm Au selectively over 1.3 µm Ni	phosphor-bronze, 0.38 µm Au selectively over 1.3 µm Ni
Performance level	3	3
Nominal voltage acc. to VDE 01 10 Part 1/4.97, IEC 60664-1	50 V / 0.8 kV / 2	50 V / 0.8 kV / 2
Dimensions (mm) W x H x L incl. mounting feet or mounting carrier	W x 28 x 63,5	W x 36 x 85
Wire connection	Height from upper-edge of DIN 35 rail CAGE CLAMP® (WAGO 236 Series)	Height from upper-edge of DIN 35 rail CAGE CLAMP® (WAGO 236 Series)
Cross sections	0.08 mm² ... 2.5 mm² / AWG 28 ... 12	0.08 mm² ... 2.5 mm² / AWG 28 ... 12
Stripped lengths	5 ... 6 mm / 0.22 in	5 ... 6 mm / 0.22 in
Accessories		
WMB Multi marking system for mounting carrier		see page 323
Marker strips for mounting carrier		white 709-198 / transparent 709-197

	<p>Interface module for connectors acc. to DIN 41 612, with male connector, type E, with strain relief device for ERNI mating connector Mounting carrier for DIN 35 rail</p>	<p>Interface module for connectors acc. to DIN 41 612, with male connector, type F, with strain relief device for Harting mating connector Mounting carrier for DIN 35 rail</p>
--	--	---

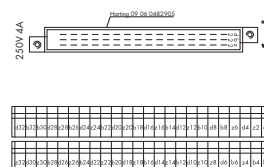
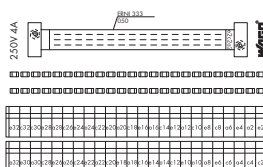
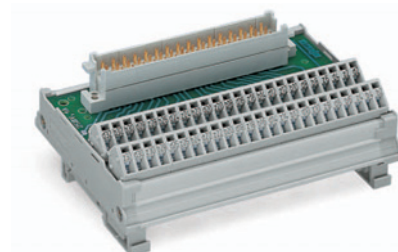
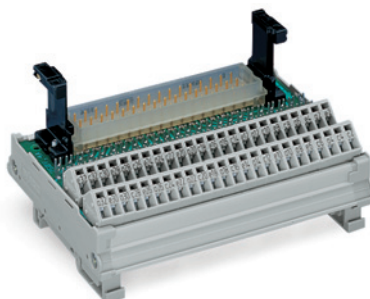

Description	No. of Poles	Width	Item No.	Pack. Unit	No. of Poles	Width	Item No.	Pack. Unit
Interface module	48	128	289-434	1	48	128	289-436	1

Technical Data								
Operating voltage	250 V AC / DC				250 V AC / DC			
Nominal current	4 A				4 A			
Connector contact	Copper alloy, gold plated				Copper alloy, gold plated			
Contact resistance	≤ 16 mΩ				≤ 16 mΩ			
Performance level	2 / 400 mating cycles				1 / 500 mating cycles			
Nominal voltage acc. to VDE 01 10 Part 1/4.97, IEC 60664-1	250 V / 1.5 kV / 2				250 V / 1.5 kV / 2			
Dimensions (mm) W x H x L incl. mounting feet or mounting carrier	W x 55 x 85				W x 39 x 85			
Wire connection	Height from upper-edge of DIN 35 rail CAGE CLAMP® (WAGO 236 Series)				Height from upper-edge of DIN 35 rail CAGE CLAMP® (WAGO 236 Series)			
Cross sections	0.08 mm² ... 2.5 mm² / AWG 28 ... 12				0.08 mm² ... 2.5 mm² / AWG 28 ... 12			
Stripped lengths	5 ... 6 mm / 0.22 in				5 ... 6 mm / 0.22 in			
Accessories	see page 323				see page 323			
WMB Multi marking system for mounting carrier	white 709-198 / transparent 709-197				white 709-198 / transparent 709-197			
Marker strips for mounting carrier	white 709-198 / transparent 709-197				white 709-198 / transparent 709-197			

	<p>Interface module for connectors acc. to DIN 41 612, with female connector, type C, mating direction vertical, for male connector with solder contact Mounting carrier for DIN 35 rail</p>	<p>Interface module for connectors acc. to DIN 41 612, with female connector, type C, mating direction vertical, for female connector with IDC connection or with solder contact Mounting carrier for DIN 35 rail</p>
--	---	--

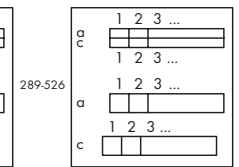
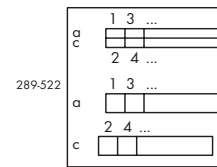
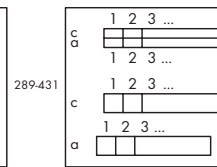
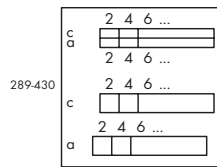
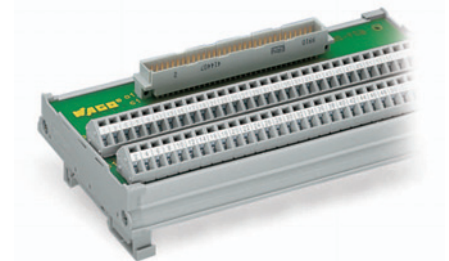
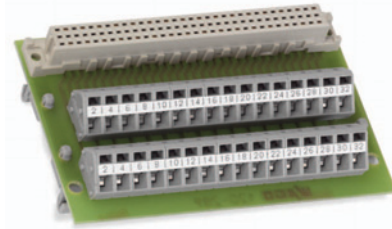

Description	No. of Poles	Width	Item No.	Pack. Unit	No. of Poles	Width	Item No.	Pack. Unit
Interface module	32	97	289-430	1	64	171	289-522	1
	64	187	289-431	1	64	171	289-526	1

Technical Data

Operating voltage	125 V AC / DC	125 V AC / DC
Nominal current	1 A	1 A
Connector contact	Copper alloy, gold plated	Copper alloy, gold plated
Contact resistance	≤ 20 mΩ	≤ 20 mΩ
Performance level	2 / 400 mating cycles	2 / 400 mating cycles
Nominal voltage acc. to VDE 01 10 Part 1/4.97, IEC 60664-1	50 V / 0.8 kV / 2	125 V / 0.8 kV / 2
Dimensions (mm) W x H x L incl. mounting feet or mounting carrier	W x 21 x 63,5	W x 34 x 85
Wire connection	Height from upper-edge of DIN 35 rail CAGE CLAMP® (WAGO 236 Series)	Height from upper-edge of DIN 35 rail CAGE CLAMP® (WAGO 236 Series)
Cross sections	0.08 mm² ... 2.5 mm² / AWG 28 ... 12	0.08 mm² ... 2.5 mm² / AWG 28 ... 12
Stripped lengths	5 ... 6 mm / 0.22 in	5 ... 6 mm / 0.22 in
Accessories		
WMB Multi marking system for mounting carrier	see page 323	see page 323
Marker strips for mounting carrier	white 709-198 / transparent 709-197	white 709-198 / transparent 709-197

	<p>Interface module for connectors acc. to DIN 41 612, with female connector, type C, mating direction horizontal, for female connector with IDC connection or with solder contact Mounting carrier for DIN 35 rail</p>	<p>Interface module for connectors acc. to DIN 41 612, with female connector, type C, mating direction vertical, for male connector with solder contact Mounting carrier for DIN 35 rail</p>
--	--	---

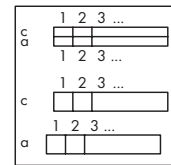
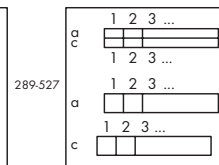
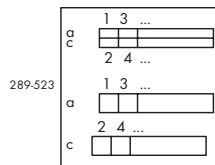
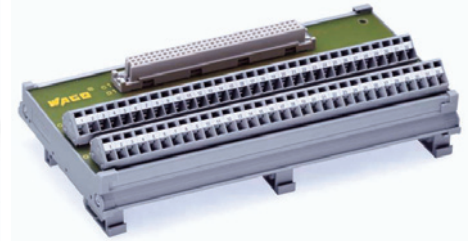

Description	No. of Poles	Width	Item No.	Pack. Unit	No. of Poles	Width	Item No.	Pack. Unit
Interface module	64	171	289-523	1	64	171	289-531	1
	64	171	289-527	1				

Technical Data

Operating voltage	125 V AC / DC	125 V AC / DC
Nominal current	1 A	1 A
Connector contact	Copper alloy, gold plated	Copper alloy, gold plated
Contact resistance	≤ 20 mΩ	≤ 20 mΩ
Performance level	2 / 400 mating cycles	2 / 400 mating cycles
Nominal voltage acc. to VDE 01 10 Part 1/4.97, IEC 60664-1	125 V / 0.8 kV / 2	125 V / 0.8 kV / 2
Dimensions (mm) W x H x L incl. mounting feet or mounting carrier	W x 34 x 85	W x 34 x 85
Wire connection	Height from upper-edge of DIN 35 rail CAGE CLAMP® (WAGO 236 Series)	Height from upper-edge of DIN 35 rail CAGE CLAMP® (WAGO 236 Series)
Cross sections	0.08 mm² ... 2.5 mm² / AWG 28 ... 12	0.08 mm² ... 2.5 mm² / AWG 28 ... 12
Stripped lengths	5 ... 6 mm / 0.22 in	5 ... 6 mm / 0.22 in
Accessories		
WMB Multi marking system for mounting carrier	see page 323	see page 323
Marker strips for mounting carrier	white 709-198 / transparent 709-197	white 709-198 / transparent 709-197

SIMATIC® is a registered trademark of the Siemens AG

Interface module, 8-pole,
for Siemens-SIMATIC® S5-95 U to 155 U,
S7-300/ET 200 M und S7-400
Single-wire connection,
without LED
Mounting carrier for DIN 35 rail

Interface module, 8-pole,
for Siemens-SIMATIC® S5-95 U to 155 U,
S7-300/ET 200 M und S7-400
Single-wire connection,
with LED
Mounting carrier for DIN 35 rail

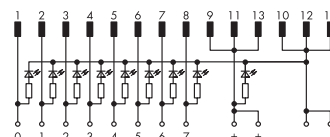
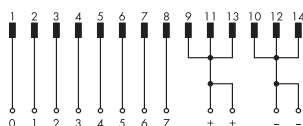

Description	Width	Item No.	Pack. Unit	Width	Item No.	Pack. Unit
Interface module	44	289-680	1	44	289-681	1
Technical Data						
Operating voltage	125 V AC/DC			24 V DC		
Nominal current per signal wire	1 A			1 A		
Max. total current (supply)	2 A			2 A		
Connector contact	phosphor-bronze, 0.38 µm Au selectively over 1.3 µm Ni			phosphor-bronze, 0.38 µm Au selectively over 1.3 µm Ni		
Performance level	3			3		
Nominal voltage acc. to VDE 0110 Part 1/4.97, IEC 60664-1	125 V / 0.8 kV / 2					
Dimensions (mm) W x H x L incl. mounting feet or mounting carrier	W x 48 x 85			W x 48 x 85		
Wire connection	Height from upper-edge of DIN 35 rail CAGE CLAMP® (WAGO 736 Series)			Height from upper-edge of DIN 35 rail CAGE CLAMP® (WAGO 736 Series)		
Cross sections	0.08 mm² ... 2.5 mm² / AWG 28 ... 12			0.08 mm² ... 2.5 mm² / AWG 28 ... 12		
Stripped lengths	5 ... 6 mm / 0.22 in			5 ... 6 mm / 0.22 in		
Accessories						
WMB Multi marking system for mounting carrier	see page 323			see page 323		
Marker strips for mounting carrier	white 709-198 / transparent 709-197			white 709-198 / transparent 709-197		

<p>SIMATIC® is a registered trademark of the Siemens AG</p>	<p>Interface module, 8-pole, for Siemens-SIMATIC® S5-95 U to 155 U, S7-300/ET 200 M und S7-400 3-wire sensors, without LED Mounting carrier for DIN 35 rail</p>	<p>Interface module, 8-pole, for Siemens-SIMATIC® S5-95 U to 155 U, S7-300/ET 200 M und S7-400 3-wire sensors, with LED Mounting carrier for DIN 35 rail</p>
---	---	--

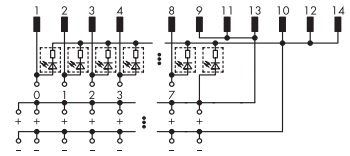
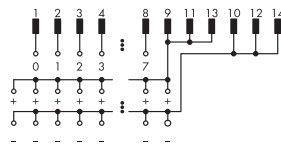
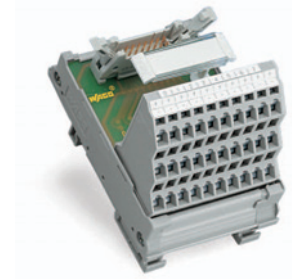
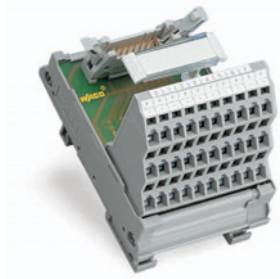

Description	Width	Item No.	Pack. Unit	Width	Item No.	Pack. Unit
Interface module	54	289-682	1	54	289-683	1

Technical Data						
Operating voltage	125 V AC/DC			24 V DC		
Nominal current per signal wire	1 A			1 A		
Max. total current (supply)	2 A			2 A		
Connector contact	phosphor-bronze, 0.38 µm Au selectively over 1.3 µm Ni			phosphor-bronze, 0.38 µm Au selectively over 1.3 µm Ni		
Performance level	3			3		
Nominal voltage acc. to VDE 01 10 Part 1/4.97, IEC 60664-1	125 V / 0.8 kV / 2					
Dimensions (mm) W x H x L incl. mounting feet or mounting carrier	W x 62 x 85			W x 62 x 85		
Wire connection	Height from upper-edge of DIN 35 rail CAGE CLAMP® (WAGO 737 Series)			Height from upper-edge of DIN 35 rail CAGE CLAMP® (WAGO 737 Series)		
Cross sections	0.08 mm² ... 2.5 mm² / AWG 28 ... 12			0.08 mm² ... 2.5 mm² / AWG 28 ... 12		
Stripped lengths	5 ... 6 mm / 0.22 in			5 ... 6 mm / 0.22 in		
Accessories						
WMB Multi marking system for mounting carrier	see page 323			see page 323		
Marker strips for mounting carrier	white 709-198 / transparent 709-197			white 709-198 / transparent 709-197		

Interface Modules

for Siemens-SIMATIC® S5-95 U to 155 U, S7-300/ET 200 M and S7-400

SIMATIC® is a registered trademark of the Siemens AG	Interface module, 32-pole, for Siemens-SIMATIC® S5-95 U to 155 U, S7-300/ET 200 M und S7-400 Single-wire connection, without LED Mounting carrier for DIN 35 rail	Interface module, 32-pole, for Siemens-SIMATIC® S5-95 U to 155 U, S7-300/ET 200 M und S7-400 Single-wire connection, with LED Mounting carrier for DIN 35 rail
--	---	--

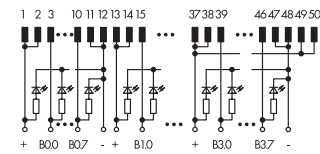
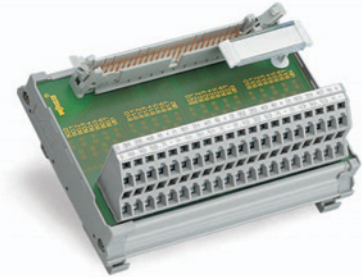
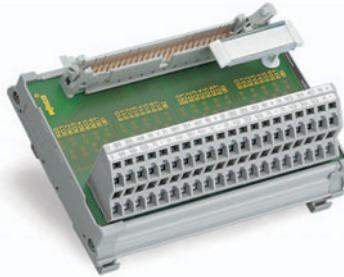

Description	Width	Item No.	Pack. Unit	Width	Item No.	Pack. Unit
Interface module	112	289-684	1	112	289-685	1

Technical Data						
Operating voltage	125 V AC/DC			24 V DC		
Nominal current per signal wire	1 A			1 A		
Max. total current (supply)	2 A / byte			2 A / byte		
Connector contact	phosphor-bronze, 0.38 µm Au selectively over 1.3 µm Ni			phosphor-bronze, 0.38 µm Au selectively over 1.3 µm Ni		
Performance level	3			3		
Nominal voltage acc. to VDE 0110 Part 1/4.97, IEC 60664-1	125 V / 0.8 kV / 2					
Dimensions (mm) W x H x L incl. mounting feet or mounting carrier	W x 48 x 85			W x 48 x 85		
Wire connection	Height from upper-edge of DIN 35 rail CAGE CLAMP® (WAGO 736 Series)			Height from upper-edge of DIN 35 rail CAGE CLAMP® (WAGO 736 Series)		
Cross sections	0.08 mm² ... 2.5 mm² / AWG 28 ... 12			0.08 mm² ... 2.5 mm² / AWG 28 ... 12		
Stripped lengths	5 ... 6 mm / 0.22 in			5 ... 6 mm / 0.22 in		
Accessories						
WMB Multi marking system for mounting carrier	see page 323			see page 323		
Marker strips for mounting carrier	white 709-198 / transparent 709-197			white 709-198 / transparent 709-197		

<p>SIMATIC® is a registered trademark of the Siemens AG</p>	<p>Interface module, 32-pole, for Siemens-SIMATIC® S5-95 U to 155 U, S7-300/ET 200 M und S7-400 3-wire sensors, without LED Mounting carrier for DIN 35 rail</p>	<p>Interface module, 32-pole, for Siemens-SIMATIC® S5-95 U to 155 U, S7-300/ET 200 M und S7-400 3-wire sensors, with LED Mounting carrier for DIN 35 rail</p>
---	--	---

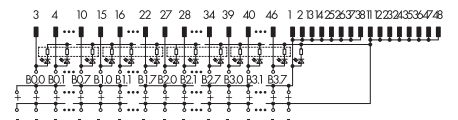
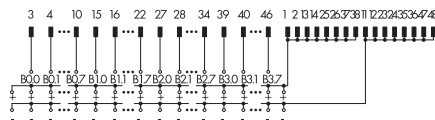
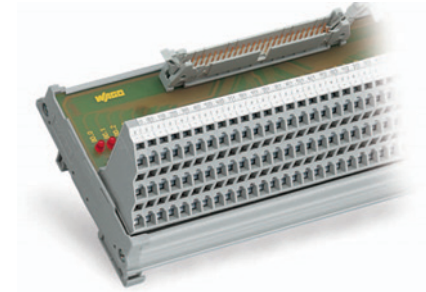
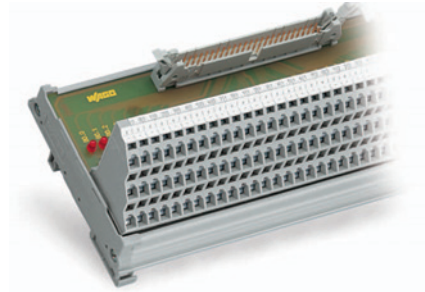

Description	Width	Item No.	Pack. Unit	Width	Item No.	Pack. Unit
Interface module	176	289-686	1	176	289-687	1

Technical Data

Operating voltage	125 V AC/DC	24 V DC
Nominal current per signal wire	1 A	1 A
Max. total current (supply)	2 A / byte	2 A / byte
Connector contact	phosphor-bronze, 0.38 µm Au selectively over 1.3 µm Ni	phosphor-bronze, 0.38 µm Au selectively over 1.3 µm Ni
Performance level	3	3
Nominal voltage acc. to VDE 01 10 Part 1/4.97, IEC 60664-1	125 V / 0.8 kV / 2	
Dimensions (mm) W x H x L incl. mounting feet or mounting carrier	W x 62 x 85	W x 62 x 85
Wire connection	Height from upper-edge of DIN 35 rail CAGE CLAMP® (WAGO 737 Series)	Height from upper-edge of DIN 35 rail CAGE CLAMP® (WAGO 737 Series)
Cross sections	0.08 mm² ... 2.5 mm² / AWG 28 ... 12	0.08 mm² ... 2.5 mm² / AWG 28 ... 12
Stripped lengths	5 ... 6 mm / 0.22 in	5 ... 6 mm / 0.22 in

Accessories

WMB Multi marking system for mounting carrier Marker strips for mounting carrier	see page 323 white 709-198 / transparent 709-197	see page 323 white 709-198 / transparent 709-197
---	---	---

2 16-Channel I/O Module with Interface Module

172

The new 750-14xx and 750-15xx Series I/O Modules with flat ribbon cable connection offer 16 digital channels in a module less than 1/2 inch (12mm) wide. Offering quick connections and a space-efficient design, the DIN-rail mount interface modules simplify installation in confined areas and relocate the termination point. When combined with WAGO interface modules (e.g., item no. 289-614, 289-611), a switch cabinet can be pre-wired before install to minimize wiring time and errors. This is beneficial as wiring can be performed independently of a plant's construction. Pre-wired electronics can be installed right before start-up,

saving valuable time during final stages of project completion. The modules are also ideal for connecting series machines or relay modules tasked with the higher loads common to buildings and industrial applications. The interface module also combines the advantages of relays (e.g., manual operation or rapid replacement with socked-mounted versions) with the benefits of a modern I/O system. Another ideal application would be the integration of pneumatic controllers into a fieldbus network. Most pneumatic modules have an appropriate connector and can be controlled by the WAGO-I/O-SYSTEM.

Five variants are available: two 16-channel input or output modules (one high-side and one low-side switching variant), as well as a version combining 8 inputs and 8 outputs.

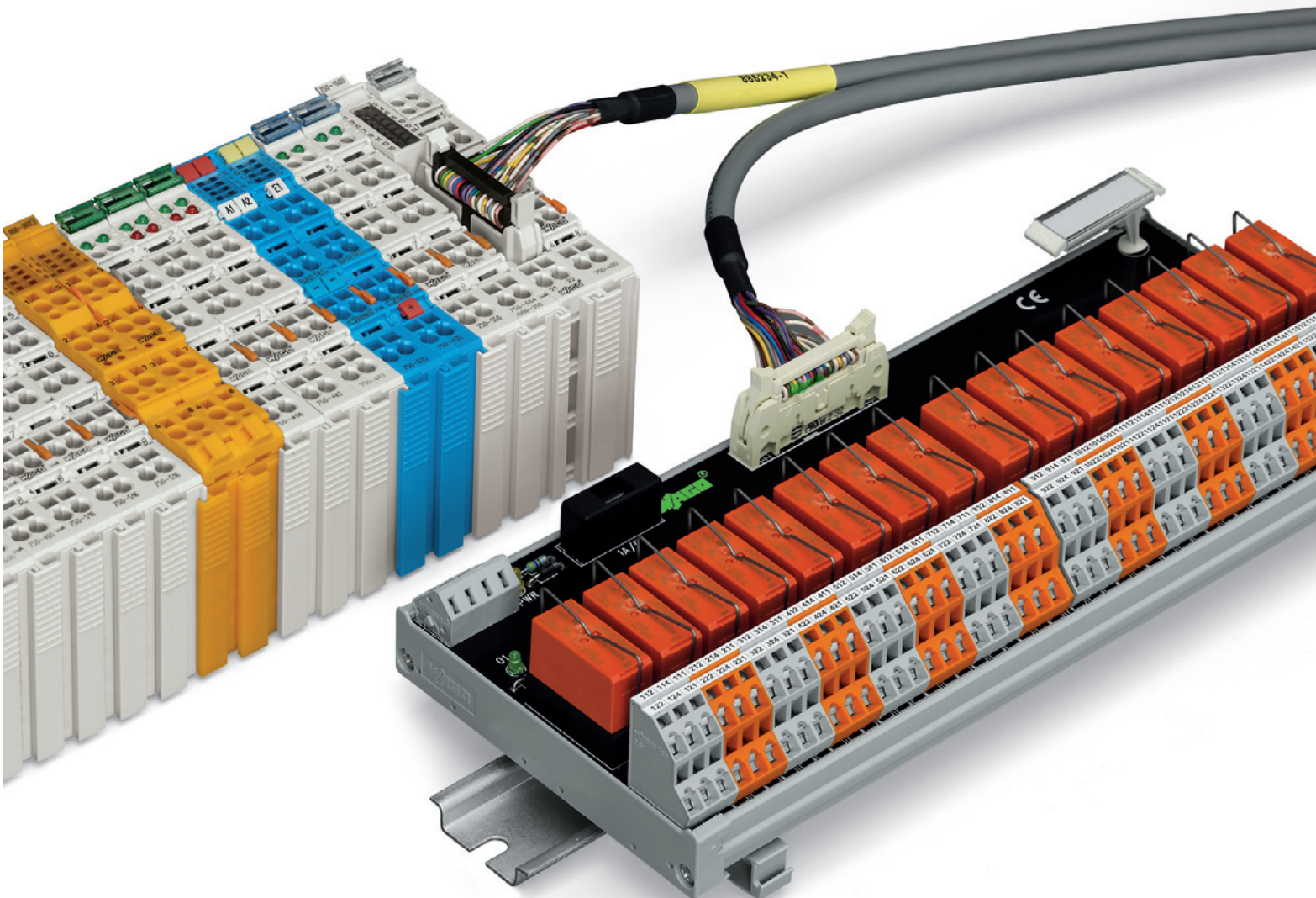

Item No.	Designation	PLC	Card	
704-5024 704-5044 704-5004 704-5014 704-5034 704-5054 704-5074 704-5064	T16S	Siemens S7-300	6ES7 313-5BE01-0AB0	6ES7 314-6CG03-0AB0
			6ES7 313-5BF03-0AB0	6ES7 322-1BH01-0AA0
			6ES7 313-6BE01-0AB0	6ES7 322-1BH10-0AA0
			6ES7 313-6BF03-0AB0	6ES7 322-1BH80-0AA0
			6ES7 313-6CE01-0AB0	6ES7 322-1BL00-0AA0
			6ES7 313-6CF03-0AB0	6ES7 322-1BP00-0AA0
			6ES7 314-6BF01-0AB0	6ES7 322-1EH01-0AA0
			6ES7 314-6BG03-0AB0	6ES7 323-1BL00-0AA0
			6ES7 314-6CF01-0AB0	
		GEFANUC 90-30 / ALSPA 80-35	IC693 MDL740	IC693 MDL753
			IC693 MDL742	
		SCHNEIDER TSX 37 (Micro)	TSX DMZ 28DT	TSX DMZ 64DTK
			TSX DMZ 28DTK	
		SCHNEIDER TSX 57 (Premium)	TSX DSY 16T2	TSX DMY 28FK
			TSX DSY 32T2K	TSX DMY 28RFK
			TSX DSY 64T2K	
		SCHNEIDER M340	BMX DDO 1602	BMX DDO 6402K
			BMX DDO 3202K	BMX DDM 3202K
		SCHNEIDER QUANTUM	140 DDO 353 00	140 DDO 843 00
			140 DDO 353 01	140 DVO 853 00
			140 DDO 364 00	
		ROCKWELL COMPACT-LOGIX (1769)	1769 - OB16	1769 - OB32
			1769 - OB16P	1769 - OB32T
		ROCKWELL CONTROL-LOGIX (1756)	1756 - OB16D	1756 - OB32
			1756 - OB16E	
		WAGO-I/O-SYSTEM 750/753	753-530 (x2)	
			750-1500	
		704-5003 704-5013	T8S	SIEMENS S7-300
6ES7 312-5BE03-0AB0	6ES7 323-1BH01-0AA0			
6ES7 322-1BF01-0AA0	6ES7 327-1BH00-0AB0			
GEFANUC 90-30 / ALSPA 80-35	IC693 MDL730			TSX DSZ 08T2
	IC693 MDL732			TSX DSZ 08T2K
	TSX DSZ 04T22			TSX DMZ 16DTK
SCHNEIDER TSX 57 (Premium)	TSX DSY 08T2			
SCHNEIDER M340	BMX DDM 16022			
SCHNEIDER QUANTUM	140 DDM 390 00			
ROCKWELL COMPACT LOGIX (1769)	1769 - OB8			
ROCKWELL CONTROL LOGIX (1756)	1756 - OB8			1756 - OB8I
	1756 - OB8EI			
WAGO-I/O-SYSTEM 750/753	753-530			
	750-1502, -1500			

Relay output module with miniature switching relay for 16 channels, 1 changeover contact each (1 u) with integrated status indication, 20-pole ribbon cable connector to DIN 41651

Relay output module with miniature switching relay for 16 channels, 1 changeover contact each (1 u) with integrated status indication and manual operation, 20-pole ribbon cable connector to DIN 41651

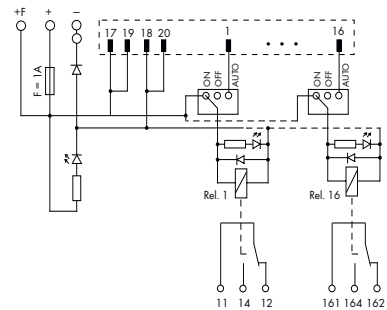
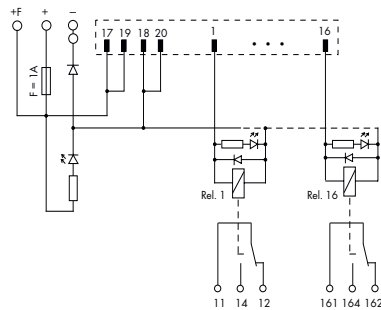

Description	Item No.	Pack. Unit	Item No.	Pack. Unit
Switching relay module, for DIN 35 rail	704-5024	1	704-5044	1
Technical Data				
Contact material	AgNi 90/10		AgNi 90/10	
Contact type	1 changeover contact		1 changeover contact	
Operating voltage	24 V DC (± 10 %)		24 V DC (± 10 %)	
Max. switching voltage	250 V AC / 48 V DC		250 V AC / 48 V DC	
Max. continuous current	5 A		5 A	
Max. switching power (resistive)	1250 VA / 50 W		1250 VA / 50 W	
Status indication	LED green : Channel LED yellow : Power supply		LED green : Channel LED yellow : Power supply	
Mechanical life	10 x 10 ⁶ switching operations		10 x 10 ⁶ switching operations	
Dielectric strength contact-coil (AC, 1 min)	4 kV		4 kV	
Dielectric strength contact-contact	1 kV		1 kV	
Fuse	Supply: 1 A Relay output: -		Supply: 1 A Relay output: -	
Ambient operating temperature	-25 °C ... +40 °C		-25 °C ... +40 °C	
Storage temperature	-40 °C ... +70 °C		-40 °C ... +70 °C	
Dimensions (mm) L x W x H incl. mounting carrier and relay	111 x 65 x 105		121 x 65 x 105	
Wire connection	Height from upper-edge of DIN 35 rail Input: 20-pole ribbon cable connector to DIN 41651 Output: CAGE CLAMP®		Height from upper-edge of DIN 35 rail Input: 20-pole ribbon cable connector to DIN 41651 Output: CAGE CLAMP®	
Cross sections	0.08 mm ² ... 2.5 mm ² / AWG 28 ... 12		0.08 mm ² ... 2.5 mm ² / AWG 28 ... 12	
Stripped lengths	5 ... 6 mm / 0.22 in		5 ... 6 mm / 0.22 in	
Application examples	see page 173		see page 173	
Accessories	Spare relay 857-152		Spare relay 857-152	

	<p>Relay output module with miniature switching relay for 16 channels, 1 changeover contact each (1 u) with integrated status indication, 20-pole ribbon cable connector to DIN 41651</p>	<p>Relay output module with miniature switching relay for 16 channels, 1 changeover contact each (1 u) with integrated status indication and output fuse, 20-pole ribbon cable connector to DIN 41651</p>
--	---	---

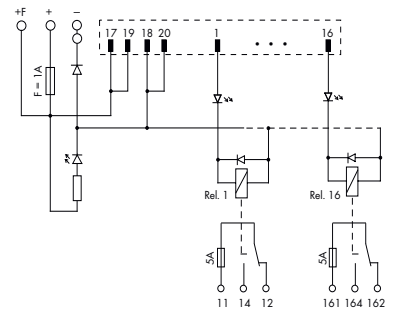
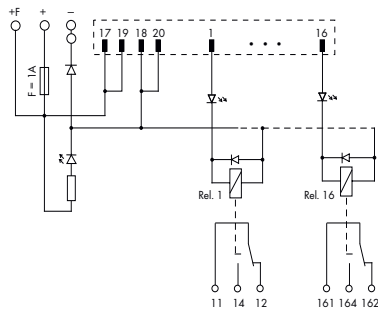
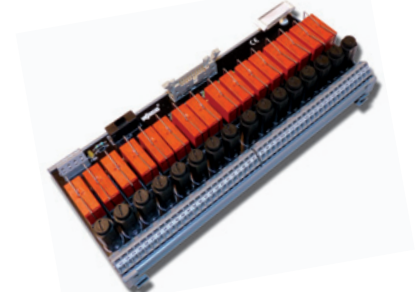
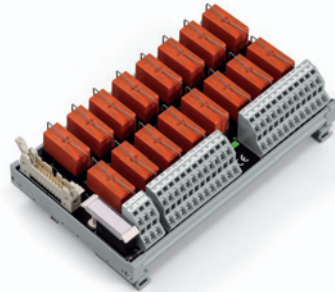

Description	Item No.	Pack. Unit	Item No.	Pack. Unit
Switching relay module, for DIN 35 rail	704-5004	1	704-5034	1
Switching relay module without miniature switching relay, for DIN 35 rail	704-5014	1		

Technical Data

Contact material	AgNi 90/10	AgNi 90/10
Contact type	1 changeover contact	1 changeover contact
Operating voltage	24 V DC (± 10 %)	24 V DC (± 10 %)
Max. switching voltage	250 V AC / 48 V DC	250 V AC / 48 V DC
Max. continuous current	5 A	5 A
Inrush current	2 s 16 A	2 s 16 A
Max. switching power (resistive)	1250 VA / 50 W	1250 VA / 50 W
Status indication	LED green : Channel LED yellow : Power supply	LED green : Channel LED yellow : Power supply
Mechanical life	30 x 10 ⁶ switching operations	30 x 10 ⁶ switching operations
Dielectric strength contact-coil (AC, 1 min)	3 kV	4 kV
Dielectric strength contact-contact	1 kV	1 kV
Fuse	Supply: 1 A Relay output: -	Supply: 1 A Relay output: 5 A
Ambient operating temperature	-25 °C ... +50 °C	-25 °C ... +50 °C
Storage temperature	-40 °C ... +70 °C	-40 °C ... +70 °C
Dimensions (mm) L x W x H incl. mounting carrier and relay	180 x 50 x 105	247 x 55 x 105
Wire connection	Height from upper-edge of DIN 35 rail Input: 20-pole ribbon cable connector to DIN 41651 Output: CAGE CLAMP®	Height from upper-edge of DIN 35 rail Input: 20-pole ribbon cable connector to DIN 41651 Output: CAGE CLAMP®
Cross sections	0.08 mm ² ... 2.5 mm ² / AWG 28 ... 12	0.08 mm ² ... 2.5 mm ² / AWG 28 ... 12
Stripped lengths	5 ... 6 mm / 0.22 in	5 ... 6 mm / 0.22 in
Application examples	see page 173	see page 173
Accessories	Spare relay 788-154	Spare relay 788-154

Relay output module with miniature switching relay for 16 channels, 1 make contact each (1 a) with integrated status indication, disconnect terminal block and output fuse, 20-pole ribbon cable connector to DIN 41651

Relay output module with miniature switching relay for 16 channels, 1 make contact each (1 a) with integrated status indication, double disconnect terminal block and output fuse, 20-pole ribbon cable connector to DIN 41651

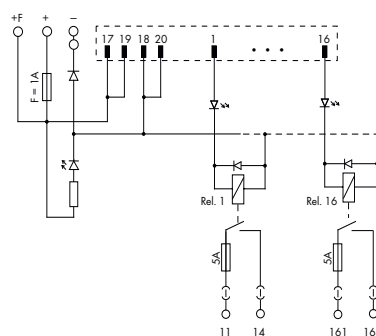
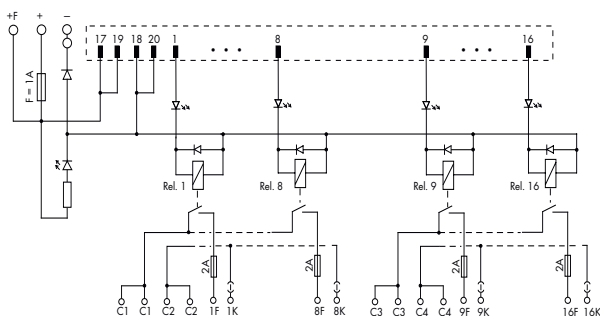
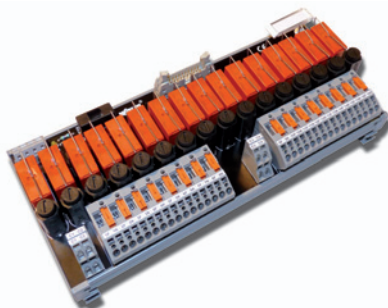

Description	Item No.	Pack. Unit	Item No.	Pack. Unit
Switching relay module, for DIN 35 rail	704-5054	1	704-5074	1

Technical Data				
Contact material	AgNi 90/10		AgNi 90/10	
Contact type	1 make contact		1 make contact	
Operating voltage	24 V DC (± 10 %)		24 V DC (± 10 %)	
Max. switching voltage	250 V AC / 48 V DC		250 V AC / 48 V DC	
Max. continuous current	2 A		5 A	
Max. switching power (resistive)	500 VA / 50 W		1250 VA / 50 W	
Status indication	LED green : Channel LED yellow : Power supply		LED green : Channel LED yellow : Power supply	
Mechanical life	30 x 10 ⁶ switching operations		30 x 10 ⁶ switching operations	
Dielectric strength contact-coil (AC, 1 min)	4 kV		4 kV	
Dielectric strength contact-contact	1 kV		1 kV	
Fuse	Supply: 1 A Relay output: 2 A		Supply: 1 A Relay output: 5 A	
Ambient operating temperature	-25 °C ... +50 °C		-25 °C ... +50 °C	
Storage temperature	-40 °C ... +70 °C		-40 °C ... +70 °C	
Dimensions (mm) L x W x H incl. mounting carrier and relay	240 x 55 x 105		240 x 55 x 105	
Wire connection	Height from upper-edge of DIN 35 rail Input: 20-pole ribbon cable connector to DIN 41651 Output: CAGE CLAMP®		Height from upper-edge of DIN 35 rail Input: 20-pole ribbon cable connector to DIN 41651 Output: CAGE CLAMP®	
Cross sections	0.08 mm ² ... 2.5 mm ² / AWG 28 ... 12		0.08 mm ² ... 2.5 mm ² / AWG 28 ... 12	
Stripped lengths	5 ... 6 mm / 0.22 in		5 ... 6 mm / 0.22 in	
Application examples	see page 173		see page 173	
Accessories	Spare relay 788-154		Spare relay 788-154	

	Relay output module with miniature switching relay for 16 channels, 2 changeover contacts each (2 u) with integrated status indication, 20-pole ribbon cable connector to DIN 41651	
--	--	--

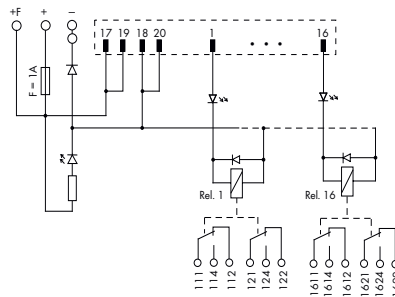

Description	Item No.	Pack. Unit
Switching relay module, for DIN 35 rail	704-5064	1
Technical Data		
Contact material	AgNi 90/10	
Contact type	2 changeover contact	
Operating voltage	24 V DC (± 10 %)	
Max. switching voltage	250 V AC / 48 V DC	
Max. continuous current	5 A	
Inrush current	2 s 8 A	
Max. switching power (resistive)	1000 VA / 50 W	
Status indication	LED green : Channel LED yellow : Power supply	
Mechanical life	30 x 10 ⁶ switching operations	
Dielectric strength contact-coil (AC, 1 min)	4 kV	
Dielectric strength contact-contact	1 kV	
Fuse	Supply: 1 A Relay output: -	
Ambient operating temperature	-25 °C ... +50 °C	
Storage temperature	-40 °C ... +70 °C	
Dimensions (mm) L x W x H incl. mounting carrier and relay	247 x 50 x 105	
Wire connection	Height from upper-edge of DIN 35 rail Input: 20-pole ribbon cable connector to DIN 41651 Output: CAGE CLAMP®	
Cross sections	0.08 mm ² ... 2.5 mm ² / AWG 28 ... 12	
Stripped lengths	5 ... 6 mm / 0.22 in	
Application examples	see page 173	
Accessories	Spare relay 788-156	

Relay output module with miniature switching relay for 8 channels, 1 changeover contact each (1 u) with integrated status indication, 10-pole ribbon cable connector to DIN 41651

Relay output module with miniature switching relay for 8 channels, 1 changeover contact each (1 u) with integrated status indication and manual operation, 10-pole ribbon cable connector to DIN 41651

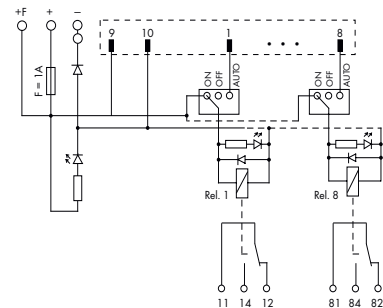
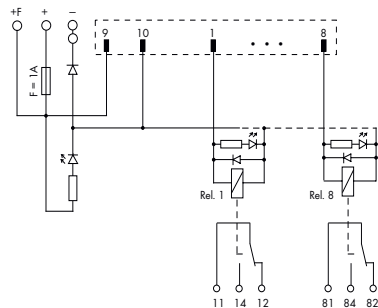
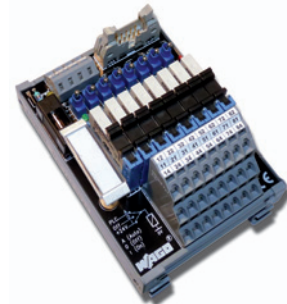
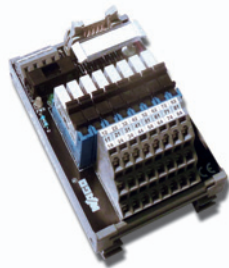

Description	Item No.	Pack. Unit	Item No.	Pack. Unit
Switching relay module, for DIN 35 rail	704-5003	1	704-5013	1
Technical Data				
Contact material	AgNi 90/10		AgNi 90/10	
Contact type	1 changeover contact		1 changeover contact	
Operating voltage	24 V DC (± 10 %)		24 V DC (± 10 %)	
Max. switching voltage	250 V AC / 48 V DC		250 V AC / 48 V DC	
Max. continuous current	5 A		5 A	
Max. switching power (resistive)	1250 VA / 50 W		1250 VA / 50 W	
Status indication	LED green : Channel LED yellow : Power supply		LED green : Channel LED yellow : Power supply	
Mechanical life	10 x 10 ⁶ switching operations		10 x 10 ⁶ switching operations	
Dielectric strength contact-coil (AC, 1 min)	4 kV		4 kV	
Dielectric strength contact-contact	1 kV		1 kV	
Fuse	Supply: 1 A Relay output: -		Supply: 1 A Relay output: -	
Ambient operating temperature	-25 °C ... +40 °C		-25 °C ... +40 °C	
Storage temperature	-40 °C ... +70 °C		-40 °C ... +70 °C	
Dimensions (mm) L x W x H incl. mounting carrier and relay	70 x 65 x 105		75 x 65 x 105	
Wire connection	Height from upper-edge of DIN 35 rail Input: 10-pole ribbon cable connector to DIN 41651 Output: CAGE CLAMP®		Height from upper-edge of DIN 35 rail Input: 10-pole ribbon cable connector to DIN 41651 Output: CAGE CLAMP®	
Cross sections	0.08 mm ² ... 2.5 mm ² / AWG 28 ... 12		0.08 mm ² ... 2.5 mm ² / AWG 28 ... 12	
Stripped lengths	5 ... 6 mm / 0.22 in		5 ... 6 mm / 0.22 in	
Application examples	see page 173		see page 173	
Accessories	Spare relay 857-152		Spare relay 857-152	

WAGO Ribbon Cables



WAGO ribbon cables provide fast and easy connection of WAGO I/O modules equipped with a ribbon cable connector (750-1400, -1402, -1500, -1501, 1502) to appropriate interface or relay modules (16-channel) featuring a 20-pole female connector. The cables are available in 1-, 2- and 3-meter lengths; each has one 20-pole female connector at both ends.

WAGO ribbon cables provide fast and easy connection of WAGO I/O modules equipped with a ribbon cable connector (750-1400, -1402, -1500, -1501, 1502) to appropriate interface or relay modules featuring a 10-pole female connector. For example, this cable connects 2 relay modules (8-channel) to a WAGO I/O module. The cables are available in 1- and 2-meter lengths; each has one 20-pole and two 10-pole female connectors on the ends.

Description	Item No.	Pack. Unit
WAGO ribbon cable 20/20, length 1 m	706-3057/300-100	1
WAGO ribbon cable 20/20, length 2 m	706-3057/300-200	1
WAGO ribbon cable 20/20, length 3 m	706-3057/300-300	1
Technical Data		
Connections	2 x 20-pole female connector acc. to DIN 41651	
Wire cross-section	0.14 mm ² LiYY	
Color coding	acc. to DIN VDE 47100	
Current per channel	max. 1 A	
Operating temperature	-25 °C ... +70 °C	
Degree of protection	IP20	
Length	1 m (706-3057/300-100) 2 m (706-3057/300-200) 3 m (706-3057/300-300)	

Description	Item No.	Pack. Unit
WAGO ribbon cable 20/2x10, length 1 m	706-7753/302-100	1
WAGO ribbon cable 20/2x10, length 2 m	706-7753/302-200	1
Technical Data		
Connections	1 x 20-pole / 2 x 10-pole female connector	
Wire cross-section	0.14 mm ² LiYY	
Color coding	acc. to DIN VDE 47100	
Current per channel	max. 1 A	
Operating temperature	-25 °C ... +70 °C	
Degree of protection	IP20	
Length	1 m (706-7753/302-100) 2 m (706-7753/302-200)	

	RJ-45 interface module Mounting carrier for DIN 35 rail	RJ-45 interface module Mounting carrier for DIN 35 rail
--	--	--

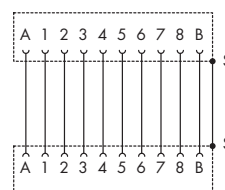
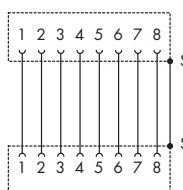
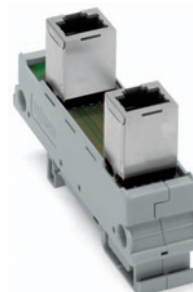
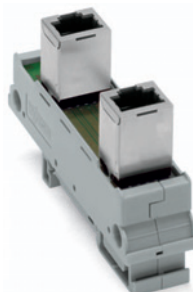

Description	Item No.	Pack. Unit	Item No.	Pack. Unit
Interface module	289-172	1	289-176	1

Technical Data

Connecting cable	min. CAT5	min. CAT5
Max. transmission length	100 m	100 m
Connector	RJ-45 shielded	RJ-45 shielded
Min. mating cycles	500	1000
Current load	≤ 1.5 A	≤ 2.1 A
Voltage load	30V AC / 42 V DC	35 V AC / 50 V DC
Insulation resistance	> 500 MΩ	> 500 MΩ
Dielectric strength contact-contact	1 kV eff.	1 kV eff.
Contact resistance typ.	< 20 mΩ	< 40 mΩ
Ambient operating temperature	-20 °C ... +85 °C	-20 °C ... +85 °C
Dimensions (mm) W x H x L incl. mounting feet or mounting carrier	20,5 x 51 x 85	30 x 51 x 85
Approvals	Height from upper-edge of DIN 35 rail ISO/IEC 11801: 2002-09; EN 55022	Height from upper-edge of DIN 35 rail ISO/IEC 11801: 2002-09; EN 55022
Accessories		
WMB Multi marking system for mounting carrier	see page 323	see page 323
Marker strips for mounting carrier	white 709-198 / transparent 709-197	white 709-198 / transparent 709-197

	RJ-45 interface module with shield clamping unit for WAGO shield (screen) clamping saddle Mounting carrier for DIN 35 rail	RJ-45 interface module with shield clamping unit for WAGO shield (screen) clamping saddle Mounting carrier for DIN 35 rail
--	---	---

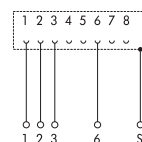
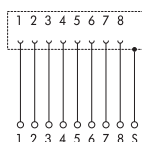

Description	Item No.	Pack. Unit	Item No.	Pack. Unit
Interface module	289-175	1	289-174	1

Technical Data				
Connecting cable	min. CAT5		min. CAT5	
Max. transmission length	100 m		100 m	
Connector	RJ-45 shielded		RJ-45 shielded	
Min. mating cycles	500		500	
Current load	≤ 1.5 A		≤ 1.5 A	
Insulation resistance	> 500 MΩ		> 500 MΩ	
Dielectric strength contact-contact	1 kV eff.		1 kV eff.	
Contact resistance	typ. < 20 mΩ		typ. < 20 mΩ	
Ambient operating temperature	-20 °C ... +85 °C		-20 °C ... +85 °C	
Dimensions (mm) W x H x L incl. mounting feet or mounting carrier	24 x 40 x 85		24 x 40 x 85	
Wire connection	Height from upper-edge of DIN 35 rail CAGE CLAMP® (WAGO 739 Series)		Height from upper-edge of DIN 35 rail CAGE CLAMP® (WAGO 739 Series)	
Cross sections	0.08 mm² ... 1.5 mm² / AWG 28 ... 14		0.08 mm² ... 1.5 mm² / AWG 28 ... 14	
Stripped lengths	5 ... 6 mm / 0.22 in		5 ... 6 mm / 0.22 in	
Approvals	ISO/IEC 11801: 2002-09; EN 55022		ISO/IEC 11801: 2002-09; EN 55022	
Accessories				
WMB Multi marking system for mounting carrier	see page 323		see page 323	
Marker strips for mounting carrier	white 709-198 / transparent 709-197		white 709-198 / transparent 709-197	
WAGO shield (screen) clamping saddle	790-108 (11 mm wide; cable diameter up to 8 mm)		790-108 (11 mm wide; cable diameter up to 8 mm)	

	Open diode gate with 8 diodes 1 N 4007 can be connected individually	Open diode gate with 8 diodes P 600 B can be connected individually
--	--	---

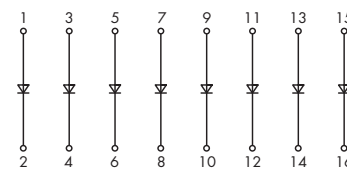
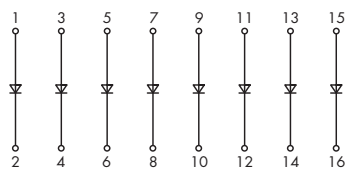
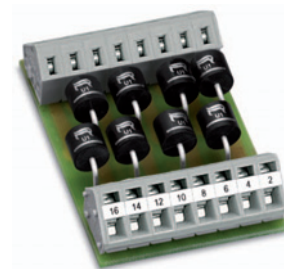
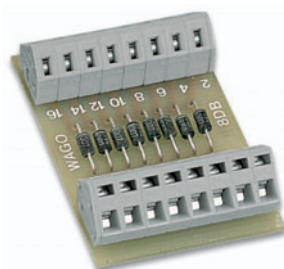

* Max. admissible current acc. to the manufacturer's data sheet. With all diodes loaded, the continuous current must be reduced.

Description	Item No.	Pack. Unit	Item No.	Pack. Unit
Open diode gate	289-101	1	289-103	1

Technical Data

Operating voltage	250 V AC/DC	100 V AC/DC
Peak reverse voltage	1000 V	100 V
Rectified current for each diode *	1 A	6 A
Nominal voltage acc. to VDE 0110 Part 1/4.97, IEC 60664-1	250 V / 4 kV / 3	250 V / 4 kV / 3
Ambient operating temperature	-25 °C ... +40 °C	-25 °C ... +30 °C
Dimensions (mm) L x W x H incl. mounting carrier and universal mounting feet	47 x 31.5 x 65.5	47 x 31.5 x 65.5
Wire connection	Height from upper-edge of DIN 35 rail CAGE CLAMP® (WAGO 236 Series)	Height from upper-edge of DIN 35 rail CAGE CLAMP® (WAGO 236 Series)
Cross sections	0.08 mm² ... 2.5 mm² / AWG 28 ... 12	0.08 mm² ... 2.5 mm² / AWG 28 ... 12
Stripped lengths	5 ... 6 mm / 0.22 in	5 ... 6 mm / 0.22 in

Accessories

Accessories	Item No.	Pack. Unit	Item No.	Pack. Unit
Mounting carrier, for screw-fixing or DIN-rail mounting (with snap-fit type universal mounting feet to be ordered separately)	288-001	1	288-001	1
Universal mounting foot; snap-fit type; suitable for DIN 15, 32 and 35 rails (also see page 258)	288-002	10	288-002	10

	<p>Open diode gate with 9 diodes 1 N 5408 can be connected individually 2 inputs/2 outputs per diode including Mounting carrier for DIN 35 rail</p>	
--	--	--

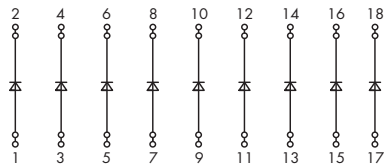

* Max. admissible current acc. to the manufacturer's data sheet. With all diodes loaded, the continuous current must be reduced.

Description	Item No.	Pack. Unit
Open diode gate	289-105	1

Technical Data

Operating voltage	250 V AC/DC	
Peak reverse voltage	1000 V	
Rectified current for each diode *	3 A	
Rectified current for each diode	10 µA	
Forward voltage for each Diode	1.3 V	
Forward current (resistent) for each diode	3 A	
Nominal voltage acc. to VDE 01 10 Part 1/4.97, IEC 60664-1	250 V / 4 kV / 3	
Ambient operating temperature	-25 °C ... +40 °C	
Dimensions (mm) L x W x H incl. mounting carrier and universal mounting feet	51 x 48 x 85	
Wire connection	Height from upper-edge of DIN 35 rail CAGE CLAMP® (WAGO 736 Series)	
Cross sections	0.08 mm² ... 2.5 mm² / AWG 28 ... 12	
Stripped lengths	5 ... 6 mm / 0.22 in	
Accessories		
WMB Multi marking system for mounting carrier	see page 323	
Marker strips for mounting carrier	white 709-198 / transparent 709-197	

2 Rail-Mounted Modules - Diode Gates

188

	Polarized diode gate with 14 diodes 1 N 4007 common cathode	Polarized diode gate with 14 diodes 1 N 4007 common anode
--	--	--

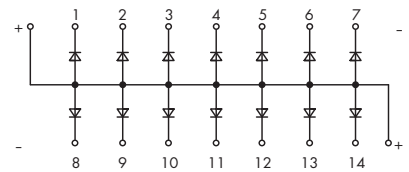
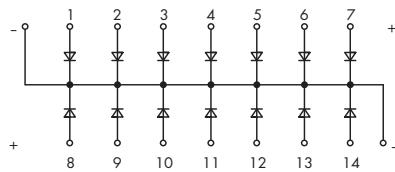
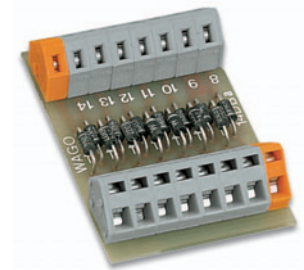
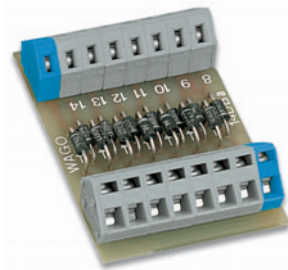

* Max. admissible current acc. to the manufacturer's data sheet. With all diodes loaded, the continuous current must be reduced.

Description	Item No.	Pack. Unit	Item No.	Pack. Unit
Polarized diode gate	289-111	1	289-121	1

Technical Data

Operating voltage	250 V AC/DC	250 V AC/DC
Peak reverse voltage	1000 V	1000 V
Rectified current for each diode *	1 A	1 A
Nominal voltage acc. to VDE 0110 Part 1/4.97, IEC 60664-1	250 V / 4 kV / 3	250 V / 4 kV / 3
Ambient operating temperature	-25 °C ... +40 °C	-25 °C ... +40 °C
Dimensions (mm) L x W x H incl. mounting carrier and universal mounting feet	47 x 31.5 x 65.5	47 x 31.5 x 65.5
Wire connection	Height from upper-edge of DIN 35 rail CAGE CLAMP® (WAGO 236 Series)	Height from upper-edge of DIN 35 rail CAGE CLAMP® (WAGO 236 Series)
Cross sections	0.08 mm ² ... 2.5 mm ² / AWG 28 ... 12	0.08 mm ² ... 2.5 mm ² / AWG 28 ... 12
Stripped lengths	5 ... 6 mm / 0.22 in	5 ... 6 mm / 0.22 in

Accessories

Accessories	Item No.	Pack. Unit	Item No.	Pack. Unit
Mounting carrier, for screw-fixing or DIN-rail mounting (with snap-fit type universal mounting feet to be ordered separately)	288-001	1	288-001	1
Universal mounting foot; snap-fit type; suitable for DIN 15, 32 and 35 rails (also see page 258)	288-002	10	288-002	10

	Lamp test circuit module with 20 diodes for testing 10 lamps with Mounting feet for DIN 35 rail	LED gate module with 16 LEDs, common anode or cathode
--	--	--

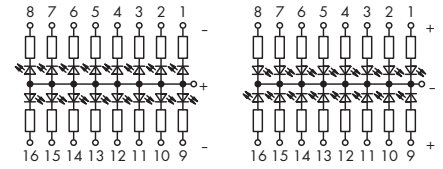
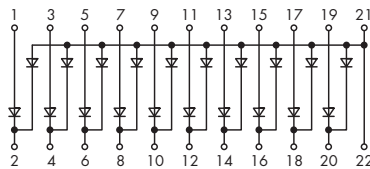
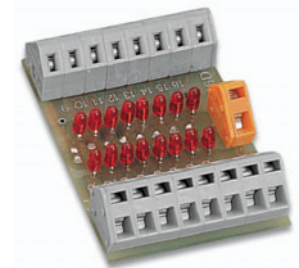
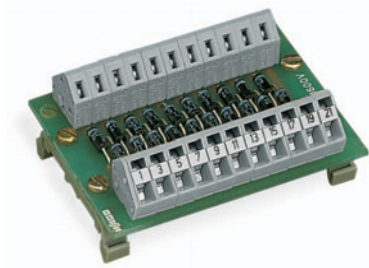

Description	Item No.	Pack. Unit	Item No.	Pack. Unit
Gate module	289-151	1	289-202	1
			289-201	1

Technical Data

Operating voltage	250 V AC/DC	24 V DC
Operating voltage range	0 V ... 250 V AC/DC	20 V ... 26 V DC
Power consumption at V_N		5.6 mA each LED
Peak reverse voltage	1600 V	
Rectified current for each diode, resistive	1 A	
Nominal voltage acc. to VDE 0110 Part 1/4.97, IEC 60664-1	250 V / 4 kV / 3	
Ambient operating temperature	-25 °C ... +40 °C	-25 °C ... +40 °C
Dimensions (mm) W x H x L incl. mounting feet or mounting carrier	69 x 21 x 50	47 x 31.5 x 65.5
Wire connection	Height from upper-edge of DIN 35 rail CAGE CLAMP® (WAGO 236 Series)	Height from upper-edge of DIN 35 rail CAGE CLAMP® (WAGO 236 Series)
Cross sections	0.08 mm ² ... 2.5 mm ² / AWG 28 ... 12	0.08 mm ² ... 2.5 mm ² / AWG 28 ... 12
Stripped lengths	5 ... 6 mm / 0.22 in	5 ... 6 mm / 0.22 in

Accessories

	Item No.	Pack. Unit
Mounting carrier, for screw-fixing or DIN-rail mounting (with snap-fit type universal mounting feet to be ordered separately)	288-001	1
Universal mounting foot; snap-fit type; suitable for DIN 15, 32 and 35 rails (also see page 258)	288-002	10

	Resistor gate with 1 end commoned, 8 resistors 2 k 2; 1 W	Open resistor gate with 8 resistors 2 k 7; 0.6 W individual connection possible
--	---	---

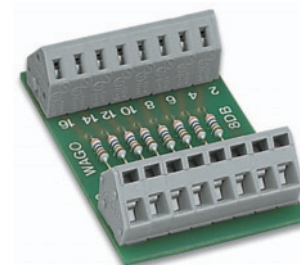
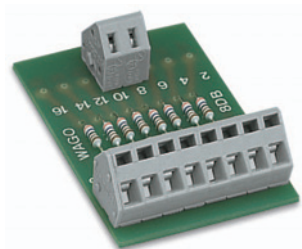

other resistors - contact factory

* Max. admissible power dissipation of a single resistor. With all resistors loaded, the max. admissible power dissipation must be reduced.

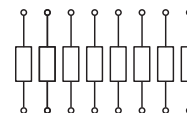
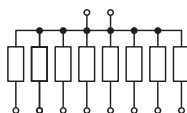

Description	Item No.	Pack. Unit	Item No.	Pack. Unit
Resistor gate	289-113	1	289-114	1

Technical Data

Operating voltage	40 V AC/DC	40 V AC/DC
Resistor type	DIN 0414	DIN 0207
Temperature coefficient	50 ppm	50 ppm
Tolerance	± 1%	± 1%
Power dissipation *	1 W	0.6 W
Ambient operating temperature	-25 °C ... +40 °C	-25 °C ... +40 °C
Dimensions (mm) L x W x H incl. mounting carrier and universal mounting feet	47 x 31.5 x 65.5	47 x 31.5 x 65.5
Wire connection	Height from upper-edge of DIN 35 rail CAGE CLAMP® (WAGO 236 Series)	Height from upper-edge of DIN 35 rail CAGE CLAMP® (WAGO 236 Series)
Cross sections	0.08 mm ² ... 2.5 mm ² / AWG 28 ... 12	0.08 mm ² ... 2.5 mm ² / AWG 28 ... 12
Stripped lengths	5 ... 6 mm / 0.22 in	5 ... 6 mm / 0.22 in

Accessories	Item No.	Pack. Unit	Item No.	Pack. Unit
Mounting carrier, for screw-fixing or DIN-rail mounting (with snap-fit type universal mounting feet to be ordered separately)	288-001	1	288-001	1
Universal mounting foot; snap-fit type; suitable for DIN 15, 32 and 35 rails (also see page 258)	288-002	10	288-002	10

	<p>Module with 2 x 8 drilled holes Diameter of drilled holes 1 mm, Pin spacing 3.83 mm x 16 mm</p>	<p>Module with 2 x 8 soldering points Pin spacing 5 mm x 12 mm</p>
--	--	--

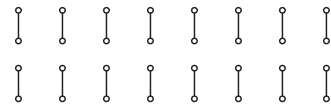
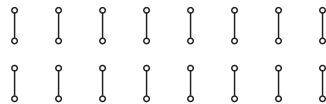
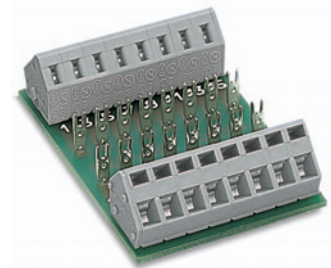
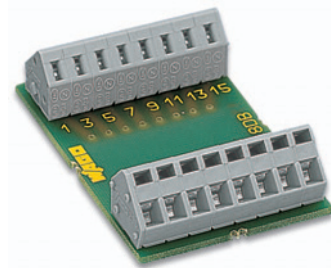

Description	Item No.	Pack. Unit	Item No.	Pack. Unit
Module for building custom circuits	289-102	1	289-131	1
Technical Data				
Operating voltage	250 V AC/DC		250 V AC/DC	
Nominal current	3 A		3 A	
Ambient operating temperature	-25 °C ... +40 °C		-25 °C ... +40 °C	
Dimensions (mm) L x W x H incl. mounting carrier and universal mounting feet	42.5 x 32 x 62.5		42.5 x 32 x 62.5	
Wire connection	Height from upper-edge of DIN 35 rail CAGE CLAMP® (WAGO 236 Series)		Height from upper-edge of DIN 35 rail CAGE CLAMP® (WAGO 236 Series)	
Cross sections	0.08 mm² ... 2.5 mm² / AWG 28 ... 12		0.08 mm² ... 2.5 mm² / AWG 28 ... 12	
Stripped lengths	5 ... 6 mm / 0.22 in		5 ... 6 mm / 0.22 in	
Accessories				
Mounting carrier, for screw-fixing or DIN-rail mounting (with snap-fit type universal mounting feet to be ordered separately)	288-001	1	288-001	1
Universal mounting foot; snap-fit type; suitable for DIN 15, 32 and 35 rails (also see page 258)	288-002	10	288-002	10

**WAGO Application: Danone Group,
Ochsenfurt Plant, Germany**
Producer of yogurt and other dairy-based products

WAGO Products:
WAGO-I/O-SYSTEM with PROFIBUS Couplers



3



857 Series

- JUMPFLEX® Transducers
- WAGOframe
- WAGO USB Service Cable
- Accessories, 857 Series
- JUMPFLEX® 8-Channel Adapters for System Wiring

194 - 219
220
221
222
223



286 Series

- Pluggable Modules - Temperature Transducers

224 - 228



786 Series

- Pluggable Modules - Analog Signal Conditioning
- Accessories

230 - 232
233

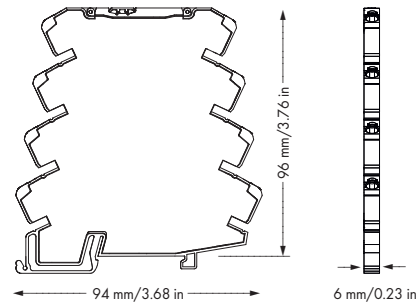
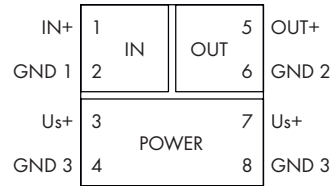
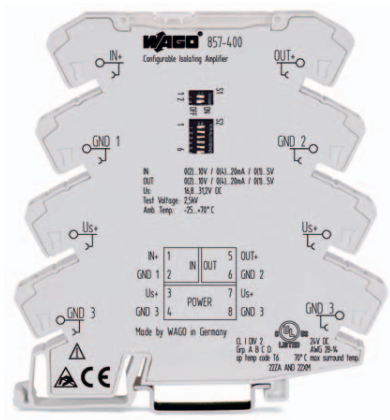

Short description:

The configurable 857-400 Isolation Amplifier is used to convert, amplify, filter and electrically isolate analog standard signals. The device has a 3-way isolation with a 2.5kV test voltage. On the input and output side, the following signals can be configured via DIP switches that are accessible from the side of the housing:

- 0 - 10V, 2 - 10V, 0 - 20mA, 4 - 20mA, 0 - 5V and 1 - 5V.
- Measurement range switching is calibrated.

The device is supplied with 24VDC, which can be commoned using lateral push-in type jumper bars in a quick and cost effective way. A green LED on the front panel indicates normal operation. The isolation amplifier meets the requirements for safe isolation of input, output and supply circuits with 2.5kV test voltage according to EN 61140.

Description	Item No.	Pack. Unit
Isolation amplifier, with zero/span adjustment	857-400	1
Accessories		
General accessories	see pages 222 - 223	
Approvals		
Shipbuilding	Ⓢ (pending)	
Ⓢ Ⓢ ANSI/ISA 12.12.01	Class I, Div. 2, Grp. ABCD, T4	
Conformity marking	CE	
General Specifications		
Dimensions (mm) W x H x L	6 x 96 x 94	
	Height from upper-edge of DIN 35 rail	
Wire connection	CAGE CLAMP®S	
Cross sections	solid: 0.08 mm ² ... 2.5 mm ² / AWG 28 ... 12	
	fine-stranded: 0.34 mm ² ... 2.5 mm ² / AWG 22 ... 12	
Stripped lengths	9 ... 10 mm / 0.37 in	

Technical Data	
Configuration	DIP switch
Input signal	0 ... 20 mA, 4 ... 20 mA, 0 ... 5 V, 0 ... 10 V, 2 ... 10 V, 1 ... 5 V (calibrated switchable)
Input resistance	≤ 50 Ω (In = mA) ≥ 100 kΩ (In = V)
Output signal	0 ... 20 mA, 4 ... 20 mA, 0 ... 5 V, 0 ... 10 V, 2 ... 10 V, 1 ... 5 V (calibrated switchable)
Load impedance	600 Ω (Out = mA) 2 kΩ (Out = V)
Max. operating frequency	100 Hz / > 5 kHz (switchable via DIP switch)
Response time (T ₁₀₋₉₀)	< 3.5 ms / < 100 μs
Zero/span adjustment	± 3 %
Voltage supply V _N	24 V DC
Supply voltage range	16.8 V ... 31.2 V
Current input at 24 V DC	< 25 mA
Transmission error	< 0.1 % of the full scale value
Temperature coefficient	0.01 %/K
Test voltage	(input/output/supply) 2.5 kV AC, 50 Hz, 1 min
Ambient operating temperature	-25 °C ... +70 °C
Storage temperature	-40 °C ... +85 °C

DIP Switch Adjustability

● = ON

857-400

Dip Switch S1 (2-fold)

Input Signal		
1	2	
●		0 ... 20 mA
●		4 ... 20 mA
	●	0 ... 10 V
	●	2 ... 10 V
		0 ... 5 V
		1 ... 5 V

Dip Switch S2 (6-fold)

Output Signal			Transmission		Max. Operating Frequency	
1	2	3	4	5	6	
						$f_{max.}$ approx. 5 kHz
					Input / Output 1 : 1	
				●	Input LZ / Output DZ	● $f_{max.}$ < 100 Hz
●	●		●		Input DZ / Output LZ	
●	●					
●	●	●				
●	●	●				

LZ = Live Zero (displaced zero-point, e.g., 4 - 20 mA)

DZ = Dead Zero (e.g., 0 - 20 mA)

Default Settings

- Input: 0 ... 20 mA
- Output: 0 ... 20 mA
- Max. Operating Frequency: > 5 kHz

JUMPFLEX® Transducers

Isolation amplifier, configurable with digital output

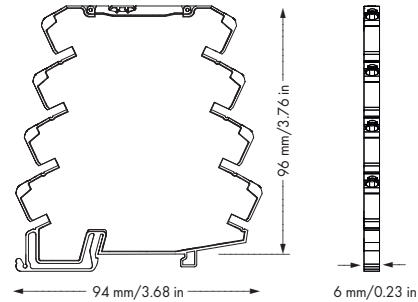
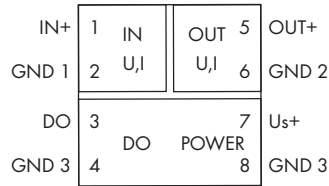
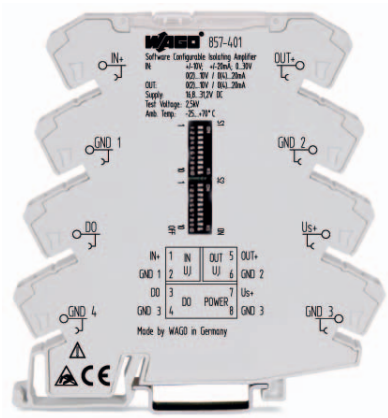

Short description:

The software-configurable 857-401 Isolation Amplifier is used to convert, amplify, filter and electrically isolate analog standard signals. The device has a 3-way isolation with a 2.5kV test voltage. DIP switches accessible from the side can be used to configure the signals in both input and output. In addition to standard signals, bipolar ($\pm 10V$, $\pm 20mA$) and 0 to 30V signals can also be set on the input side. The analog output supports standard unipolar signals. In addition, the devices can be configured using FDT/DTM software. The software offers additional setting options such as special input and output signal combinations with intermediate values or inversion of the analog output. Measurement range switching is calibrated. A digital switching output is available that can also be configured using software.

The device is supplied with 24VDC, which can be commoned using lateral push-in type jumper bars in a quick and cost effective way. A green LED on the front panel indicates normal operation. The isolation amplifier meets the requirements for safe isolation of input, output and supply circuits with 2.5kV test voltage according to EN 61140.

Description	Item No.	Pack. Unit
Isolation amplifier, configurable with digital output	857-401	1
Accessories		
Configuration software	- 759-370 FDT Frame Application - DTM (Device Tool Manager) Download: see www.wago.com	
WAGO USB Service Cable	750-923	
General accessories	see pages 222 - 223	
Approvals		
Shipbuilding	Ⓢ (pending)	
Ⓢ Ⓢ ANSI/ISA 12.12.01	Class I Div2 ABCD T4	
Conformity marking	CE	
General Specifications		
Dimensions (mm) W x H x L	6 x 96 x 94	
	Height from upper-edge of DIN 35 rail	
Wire connection	CAGE CLAMP®S	
Cross sections	solid: 0.08 mm ² ... 2.5 mm ² / AWG 28 ... 12	
	fine-stranded: 0.34 mm ² ... 2.5 mm ² / AWG 22 ... 12	
Stripped lengths	9 ... 10 mm / 0.37 in	

Technical Data	
Configuration	DIP switch or configuration software
Input signal	-10 ... +10 V, -20 ... +20 mA, 0 ... +30 V
Max. input signal	(31.2 V (U _{IN}), 100 mA (I _{IN}))
Input resistance	≤ 200 Ω (I input) > 100 kΩ (U input)
Output signal	0 ... 20 mA, 4 ... 20 mA, 0 ... 10 V, 2 ... 10 V, 0... 5 V, 1 ... 5 V, 0 ... 10 mA, 2 ... 10 mA
Load impedance	≤ 600 Ω (I output) ≥ 2 kΩ (U output)
Step response	≤ 8 ms
Voltage supply V _N	24 V DC
Supply voltage range	16.8 V ... 31.2 V
Current input at 24 V DC	< 40 mA
Transmission error	< 0.1 % of upper range value
Temperature coefficient	0.01 % /K
Min. measuring span	1 V, 2 mA (configurable)
Output - Digital	
Max. switching voltage	Supply voltage applied
Max. continuous current	500 mA (up to 60 °C) 100 mA (60 °C ... 70 °C)
Test voltage	
(input/output/supply)	2.5 kV AC, 50 Hz, 1 min.
Ambient operating temperature	-25 °C ... +70 °C
Storage temperature	-40 °C ... +85 °C

DIP Switch Adjustability

● = ON

857-401

Input Signal		Start Value															
		DIP S1															
1		2	3	4	5	6	7	V	mA	2	3	4	5	6	7	V	mA
	Voltage							0	0							●	5.5 11
●	Current	●						-10	-20	●						●	6 12
			●					-9.5	-19		●					●	6.5 13
			●	●				-9	-18	●	●					●	7 14
				●				-8.5	-17			●				●	7.5 15
			●		●			-8	-16	●		●				●	8 16
				●	●			-7.5	-15		●	●				●	8.5 17
			●	●	●			-7	-14	●	●	●				●	9 18
					●			-6.5	-13				●			●	9.5 19
			●			●		-6	-12	●			●			●	10 20
				●		●		-5.5	-11		●		●			●	10.5
			●	●		●		-5	-10	●	●		●			●	11
				●	●			-4.5	-9			●	●			●	11.5
			●		●	●		-4	-8	●		●	●			●	12
				●	●	●		-3.5	-7		●	●	●			●	13
			●	●	●	●		-3	-6	●	●	●	●			●	14
						●		-2.5	-5				●	●		●	15
			●			●		-2	-4	●			●	●		●	16
				●		●		-1.5	-3		●		●	●		●	17
			●	●		●		-1	-2	●	●		●	●		●	18
				●	●			-0.5	-1			●	●	●		●	19
			●		●	●		0	0	●		●	●	●		●	20
				●	●	●		0.5	1		●	●	●	●		●	21
			●	●	●			1	2	●	●	●		●		●	22
					●	●		1.5	3			●	●	●		●	23
			●			●		2	4	●			●	●		●	24
				●		●		2.5	5		●		●	●		●	25
			●	●		●		3	6	●	●		●	●		●	26
				●	●	●		3.5	7			●	●	●		●	27
			●		●	●		4	8	●		●	●	●		●	28
				●	●	●		4.5	9		●	●	●	●		●	29
			●	●	●	●		5	10	●	●	●	●	●		●	30

End Value															
DIP S1			DIP S2					DIP S1			DIP S2				
8	9	10	1	2	3	V	mA	8	9	10	1	2	3	V	mA
						10	20							●	5.5 11
●						-10	-20	●						●	6 12
	●					-9.5	-19		●					●	6.5 13
●	●					-9	-18	●	●					●	7 14
		●				-8.5	-17			●				●	7.5 15
●		●				-8	-16	●		●				●	8 16
	●	●				-7.5	-15		●	●				●	8.5 17
●	●	●				-7	-14	●	●	●				●	9 18
			●			-6.5	-13				●			●	9.5 19
●			●			-6	-12	●			●			●	10 20
	●			●		-5.5	-11		●		●			●	10.5
●	●			●		-5	-10	●	●		●			●	11
		●	●			-4.5	-9			●	●			●	11.5
●		●	●			-4	-8	●		●	●			●	12
	●	●	●			-3.5	-7		●	●	●			●	13
●	●	●	●			-3	-6	●	●	●	●			●	14
					●	-2.5	-5					●	●		15
●					●	-2	-4	●		●		●	●		16
	●				●	-1.5	-3		●			●	●		17
●	●				●	-1	-2	●	●			●	●		18
		●			●	-0.5	-1			●		●	●		19
●		●			●	0	0	●		●		●	●		20
	●	●			●	0.5	1		●	●		●	●		21
●	●	●			●	1	2	●	●	●		●	●		22
			●	●		1.5	3				●	●	●		23
●			●	●		2	4	●			●	●	●		24
	●		●	●		2.5	5		●		●	●	●		25
●	●		●	●		3	6	●	●		●	●	●		26
		●	●	●		3.5	7			●	●	●	●		27
●		●	●	●		4	8	●		●	●	●	●		28
	●	●	●	●		4.5	9		●	●	●	●	●		29
●	●	●	●	●		5	10	●	●	●	●	●	●		30

Output Signal Range						Measuring Range Overflow		Measuring Range Underflow		Measuring Range Overflow/Measuring Range Underflow Signalisation*		DO	
4	5	6	7	8	9	10	11	12	13	14	15	16	17
			0 ... 20 mA			Upper limit of output range +2.5%	Lower limit of output range -5%			DO Us+ switched		not active	
●			4 ... 20 mA							DO GND switched	●	active	
		●	0 ... 10 mA			Upper limit of output range +2.5%	Lower limit of output range						
		●	2 ... 10 mA										
●			0 ... 10 V			Upper limit of output range	Lower limit of output range						
●	●		2 ... 10 V										
●		●	0 ... 5 V			Upper limit of output range	Lower limit of output range						
●	●	●	1 ... 5 V										

* related to input signal

Default Settings

In delivery status all DIP switches are in the position "OFF".

Input

- Input signal: Voltage
- Start value: 0 V
- End value: 10 V

Output

- Output signal: Current
- Start value: 0 mA
- End value: 20 mA
- Measuring range underflow: 0 mA
- Measuring range overflow: 20.5 mA

Digital output

- not active

JUMPFLEX® Transducers

Bipolar isolation amplifier

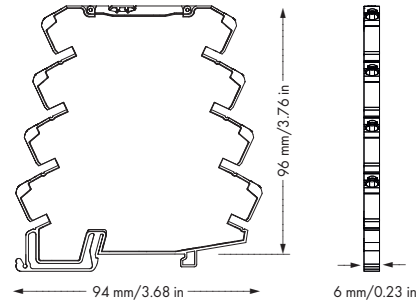
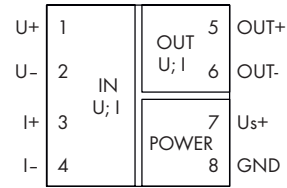
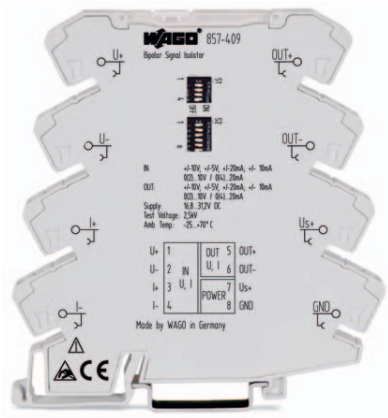

Short description:

The 857-409 Bipolar Isolation Amplifier records bipolar analog signals (e.g., ±10V or ±20mA) and converts them into bipolar, analog standard signals. After conversion, the isolated signals are transmitted with high accuracy to the output where they are available in an amplified form and are electrically isolated. In addition, unipolar signals (e.g., 0 - 20mA or 0 - 10V) and live zero signals (e.g., 4 - 20mA or 2 - 10V) can be adjusted independently of one another at both input and output via DIP switches.

Adjusting the limiting frequency is also performed via DIP switches. Measured distance adjustment is carried out via zero/span potentiometers on the front of the device, while signal switching is performed in a calibrated way, which requires no additional adjustment when switching to another range. The device is supplied with 24VDC, which can be commoned using lateral push-in type jumper bars in a quick and cost effective way. A green LED on the front panel indicates normal operation. The bipolar isolation amplifier meets the requirements for safe isolation of input, output and supply circuits with 2.5kV test voltage according to EN 61140.

Description	Item No.	Pack. Unit
Bipolar isolation amplifier	857-409	1
Accessories		
General accessories	see pages 222 - 223	
Approvals		
Shipbuilding	Ⓢ (pending)	
Ⓢ Ⓢ ANSI/ISA 12.12.01	Class I, Div. 2, Grp. ABCD, T4	
Conformity marking	CE	
General Specifications		
Dimensions (mm) W x H x L	6 x 96 x 94	
Wire connection	Height from upper-edge of DIN 35 rail CAGE CLAMP®S	
Cross sections	solid: 0.08 mm² ... 2.5 mm² / AWG 28 ... 12	
	fine-stranded: 0.34 mm² ... 2.5 mm² / AWG 22 ... 12	
Stripped lengths	9 ... 10 mm / 0.37 in	

Technical Data	
Configuration	DIP switch
Input signal	± 5 V, 0 ... 5 V, 1 ... 5 V, ± 10 V, 0 ... 10 V, 2 ... 10 V, ± 10 mA, 0 ... 10 mA, 2 ... 10 mA, ± 20 mA, 0 ... 20 mA, 4 ... 20 mA
Output signal	± 5 V, 0 ... 5 V, 1 ... 5 V, ± 10 V, 0 ... 10 V, 2 ... 10 V, ± 10 mA, 0 ... 10 mA, 2 ... 10 mA, ± 20 mA, 0 ... 20 mA, 4 ... 20 mA
Load impedance	≤ 600 Ω (I output) ≥ 2 kΩ (U output)
Max. operating frequency	100 Hz / > 5 kHz (switchable via DIP switch)
Zero/span adjustment	± 5 %
Voltage supply V _N	24 V DC
Supply voltage range	16.8 V ... 31.2 V
Transmission error	< 0.1 % of upper range value
Test voltage	(input/output/supply) 2.5 kV AC, 50 Hz, 1 min
Ambient operating temperature	-25 °C ... +70 °C
Storage temperature	-40 °C ... +85 °C

DIP Switch Adjustability

● = ON

857-409

DIP Switch S1 (4-fold)				Input
1	2	3	4	
●				± 20 mA
●	●			± 10 mA
●				± 10 V
●	●			± 5 V
				0 ... 20 mA
		●		4 ... 20 mA
	●			0 ... 10 mA
	●	●		2 ... 10 mA
				0 ... 10 V
		●		2 ... 10 V
	●			0 ... 5 V
	●	●		1 ... 5 V

DIP Switch S2 (6-fold)					Output	Max. Operating Frequency	
1	2	3	4	5		6	
			●		± 20 mA	●	< 100 Hz
		●	●		± 10 mA		approx. 5 kHz
●	●		●		± 10 V		
●	●	●	●		± 5 V		
					0 ... 20 mA		
				●	4 ... 20 mA		
		●			0 ... 10 mA		
		●		●	2 ... 10 mA		
●	●				0 ... 10 V		
●	●			●	2 ... 10 V		
●	●	●			0 ... 5 V		
●	●	●		●	1 ... 5 V		

Default Settings

- Input: ± 10 V

- Output: ± 10 V

- Max. Operating Frequency: > 5 kHz

JUMPFLEX® Transducers**CAGE CLAMP® S**

Isolation amplifiers, fixed setting for voltage or current signals

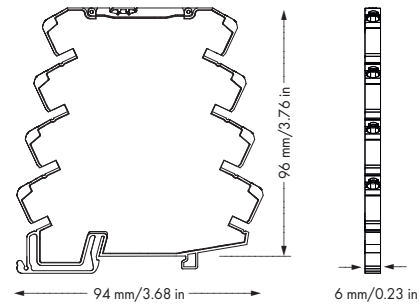
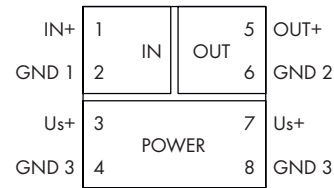
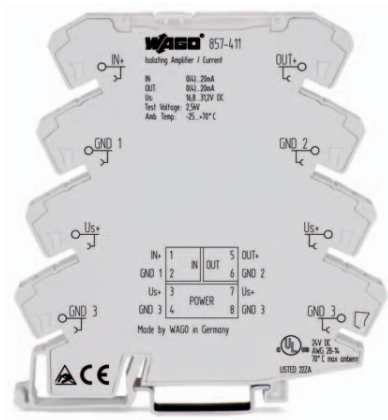
**Short description:**

The configurable isolation amplifiers convert, amplify, filter and electrically isolate analog standard signals. The devices have a 3-way isolation with a 2.5kV test voltage. The 857-411 Isolation Amplifier provides electrical isolation between the 0(4) - 20mA input and the 0(4) - 20mA output analog current signals. The 857-412 Isolation Amplifier provides electrical isolation between the 0(2) - 10V input and the 0(2) - 10V output analog voltage signals. The device is supplied with 24VDC, which can be commoned using lateral push-in type jumper bars in a quick and cost effective way. A green LED on the front panel indicates normal operation. The isolation amplifiers meet the requirements for safe isolation of input, output and supply circuits with 2.5kV test voltage according to EN 61140.

Description	Item No.	Pack. Unit
Isolation amplifier, fixed setting for current signals	857-411	1
Isolation amplifier, fixed setting for voltage signals	857-412	1
Accessories		
General accessories	see pages 222 - 223	
Approvals		
Shipbuilding	© (pending)	
ANSI/ISA 12.12.01	Class I, Div. 2, Grp. ABCD, T4	
Conformity marking	CE	
General Specifications		
Dimensions (mm) W x H x L	6 x 96 x 94	
Wire connection	Height from upper-edge of DIN 35 rail	
Cross sections	CAGE CLAMP® S	
	solid: 0.08 mm ² ... 2.5 mm ² /	
	AWG 28 ... 12	
	fine-stranded: 0.34 mm ² ... 2.5 mm ² /	
	AWG 22 ... 12	
Stripped lengths	9 ... 10 mm / 0.37 in	
Dimensions (mm) W x H x L	6 x 96 x 94	

Technical Data	
Input signal	0(4) ... 20 mA (857-411)
	0(2) ... 10 V (857-412) (857-411)
Input resistance	≤ 50 Ω (I _n = mA)
	≥ 100 kΩ (I _n = V)
Output signal	0(4) ... 20 mA (857-411) (857-411)
	0(2) ... 10 V (857-412) (857-412)
Load impedance	600 Ω (857-411)
	2 kΩ (857-412)
Max. operating frequency	100 Hz
Response time (T ₁₀₉₀)	< 3.5 ms
Voltage supply V _N	24 V DC
Supply voltage range	16.8 V ... 31.2 V
Current input at 24 V DC	< 25 mA
Transmission error	< 0.1 % of the full scale value
Temperature coefficient	0.01 %/K
Test voltage	
(input/output/supply)	2.5 kV AC, 50 Hz, 1 min
Ambient operating temperature	-25 °C ... +70 °C
Storage temperature	-40 °C ... +85 °C

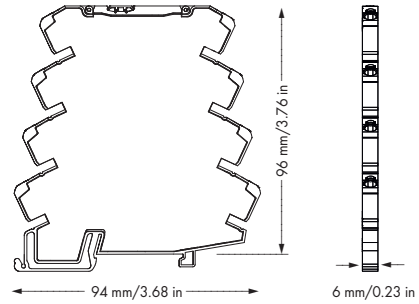
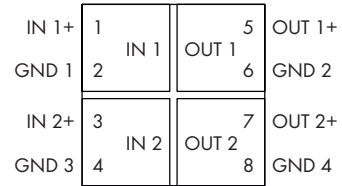
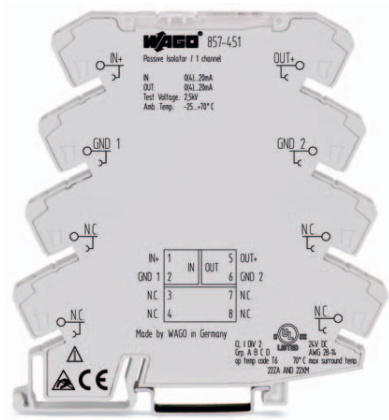

Short description:

The 1- and 2-channel passive isolators filter and electrically isolate 0(4) - 20mA analog standard signals. The devices have a 2-way isolation with a 2.5kV test voltage. The passive isolators require no additional power supply. The power required for signal isolation is derived from the input circuit.

Description	Item No.	Pack. Unit
Passive isolator, 1 channel	857-451	1
Passive isolator, 2 channels	857-452	1
Accessories		
General accessories	see pages 222 - 223	
Approvals		
Shipbuilding	Ⓢ (pending)	
ANSI/ISA 12.12.01	Class I, Div. 2, Grp. ABCD, T4	
Conformity marking	CE	
General Specifications		
Dimensions (mm) W x H x L	6 x 96 x 94	
Wire connection	Height from upper-edge of DIN 35 rail CAGE CLAMP® S	
Cross sections	solid: 0.08 mm ² ... 2.5 mm ² / AWG 28 ... 12	
	fine-stranded: 0.34 mm ² ... 2.5 mm ² / AWG 22 ... 12	
Stripped lengths	9 ... 10 mm / 0.37 in	

Technical Data	
Input signal	0(4) ... 20 mA
Voltage drop input	< 2.0 V
Output signal	0(4) ... 20 mA
Load impedance	600 Ω
Max. operating frequency	100 Hz
Response time (T ₁₀₋₉₀)	< 3.5 ms
Transmission error	< 0.1 % of the full scale value
Temperature coefficient	0.01 % /K
Ambient operating temperature	-25 °C ... +70 °C
Storage temperature	-40 °C ... +85 °C

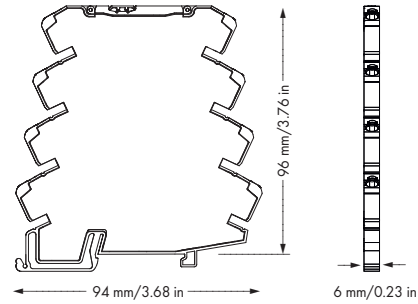
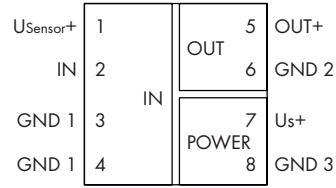
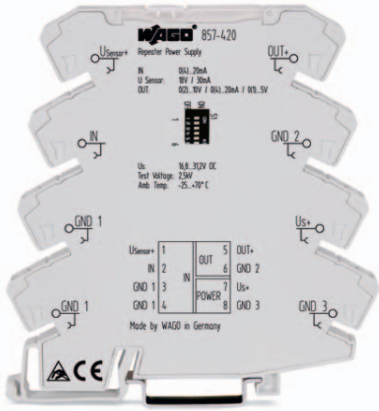

Short description:

The 857-420 Repeater Power Supply links 2- or 3-wire transmitters located in the field. It provides the power required and transmits the analog signals in an electrically isolated way. On the output side, the repeater power supply can be configured for the following analog signals: 0 - 20mA, 4 - 20mA, 0 - 10V, 2 - 10V, 0 - 5V, 1 - 15V. The device has a 3-way isolation with a 2.5kV test voltage. The devices can be configured via DIP switches that are accessible from the side of the housing. Measurement range switching is calibrated. In addition, the device can also be operated as a mere isolation amplifier. Terminal assignment: [IN+(2) and GND1(3)]. The device is supplied with 24VDC, which can be commoned using lateral push-in type jumper bars in a quick and cost effective way.

A green LED on the front panel indicates normal operation. The repeater power supply meets the requirements for safe isolation of input, output and supply circuits with 2.5kV test voltage according to EN 61140.

Description	Item No.	Pack. Unit
Repeater power supply, configurable with current and voltage output	857-420	1
Accessories		
General accessories	see pages 222 - 223	
Approvals		
Shipbuilding	© (pending)	
ANSI/ISA 12.12.01	Class I, Div. 2, Grp. ABCD, T4	
Conformity marking	CE	
General Specifications		
Dimensions (mm) W x H x L	6 x 96 x 94	
	Height from upper-edge of DIN 35 rail	
Wire connection	CAGE CLAMP®S	
Cross sections	solid: 0.08 mm ² ... 2.5 mm ² /	
	AWG 28 ... 12	
	fine-stranded: 0.34 mm ² ... 2.5 mm ² /	
	AWG 22 ... 12	
Stripped lengths	9 ... 10 mm / 0.37 in	

Technical Data	
Configuration	DIP switch
Input signal	0 ... 20 mA, 4 ... 20 mA (calibrated switchable)
Input resistance	≤ 50 Ω
Output signal	0 ... 20 mA, 4 ... 20 mA, 0 ... 5 V, 0 ... 10 V, 2 ... 10 V, 1 ... 5 V (calibrated switchable)
Load impedance	600 Ω (Out = mA) 2 kΩ (Out = V)
Max. operating frequency	100 Hz
Response time (T _{10,90})	< 3.5 ms
Voltage supply V _N	DC 24 V
Supply voltage range	16.8 V ... 31.2 V
Current input at 24 V DC	< 45 mA
Transmitter supply	V _v = 18 V at 30 mA
Transmission error	< 0.1 % of the full scale value
Temperature coefficient	0.01 % /K
Test voltage (input/output/supply)	2.5 kV AC, 50 Hz, 1 min
Ambient operating temperature	-25 °C ... +70 °C
Storage temperature	-40 °C ... +85 °C

DIP Switch Adjustability

● = ON

857-420

Input	Output	DIP 1					
		1	2	3	4	5	6
0 ... 20 mA	0 ... 20 mA						n.c.
0 ... 20 mA	4 ... 20 mA				●		n.c.
0 ... 20 mA	0 ... 10 V	●	●				n.c.
0 ... 20 mA	2 ... 10 V	●	●		●		n.c.
0 ... 20 mA	0 ... 5 V	●	●	●			n.c.
0 ... 20 mA	1 ... 5 V	●	●	●	●		n.c.
4 ... 20 mA	0 ... 20 mA					●	n.c.
4 ... 20 mA	4 ... 20 mA						n.c.
4 ... 20 mA	0 ... 10 V	●	●			●	n.c.
4 ... 20 mA	2 ... 10 V	●	●				n.c.
4 ... 20 mA	0 ... 5 V	●	●	●		●	n.c.
4 ... 20 mA	1 ... 5 V	●	●	●			n.c.

Default Settings:

- Input: 0 ... 20 mA
- Output: 0 ... 20 mA
- DIP 6: n.c. - not connected

Connection assignment

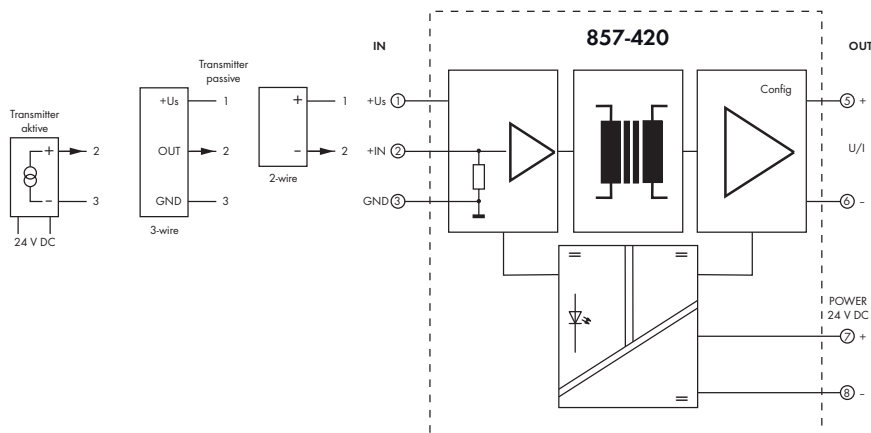

JUMPFLEX® Transducers

Repeater power supply, HART

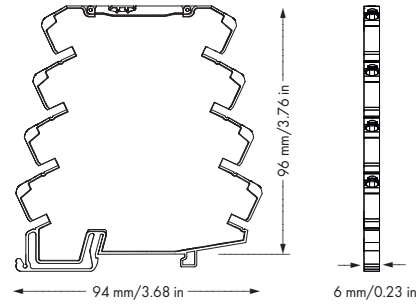
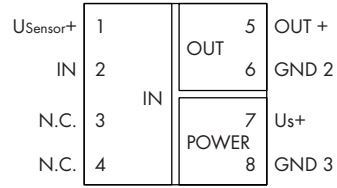
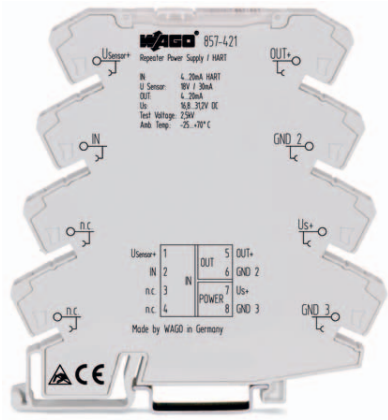

Short description:

The 857-421 HART Repeater Power Supply links SMART transmitters located in the field. It provides the power required and transmits the analog signals in an electrically isolated way. Transmission of the data protocol (e.g., HART) is bi-directional for SMART transmitters. Digital signals for data communication between transmitter and process controller are superimposed on the analog current signal, and they are used for diagnosing and calibrating the field transmitters. The device has a 3-way isolation with a 2.5kV test voltage. The device is supplied with 24VDC, which can be commoned using lateral push-in type jumper bars in a quick and cost effective way.

A green LED on the front panel indicates normal operation. The repeater power supply meets the requirements for safe isolation of input, output and supply circuits with 2.5kV test voltage according to EN 61140.

Description	Item No.	Pack. Unit
Repeater power supply, HART	857-421	1
Accessories		
General accessories	see pages 222 - 223	
Approvals		
Shipbuilding	Ⓢ (pending)	
Ⓢ-Ⓢ ANSI/ISA 12.12.01	Class I, Div. 2, Grp. ABCD, T4	
Conformity marking	CE	
General Specifications		
Dimensions (mm) W x H x L	6 x 96 x 94	
Wire connection	Height from upper-edge of DIN 35 rail CAGE CLAMP®S	
Cross sections	solid: 0.08 mm² ... 2.5 mm² / AWG 28 ... 12	
	fine-stranded: 0.34 mm² ... 2.5 mm² / AWG 22 ... 12	
Stripped lengths	9 ... 10 mm / 0.37 in	

Technical Data	
Input signal	4 ... 20 mA
Input resistance	≤ 50 Ω
Output signal	4 ... 20 mA
Load impedance	600 Ω
Max. operating frequency	100 Hz signal / ≥ 2.5 kHz HART
Response time (T ₁₀₋₉₀)	< 3.5 ms signal
Voltage supply V _N	24 V DC
Supply voltage range	16.8 V ... 31.2 V
Current input at 24 V DC	< 45 mA
Transmitter supply	V _v = 18 V at 30 mA
Transmission error	< 0.1 % of the full scale value
Temperature coefficient	0.01 % /K
Test voltage (input/output/supply)	2.5 kV AC, 50 Hz, 1 min
Ambient operating temperature	-25 °C ... +70 °C
Storage temperature	-40 °C ... +85 °C

Simultaneous transmission of analog and digital signals

857-421

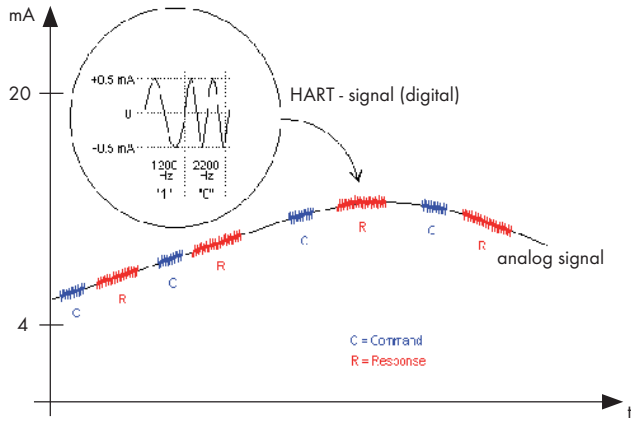

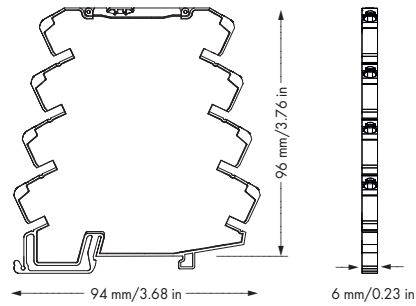
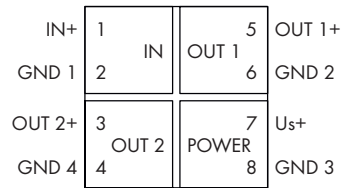
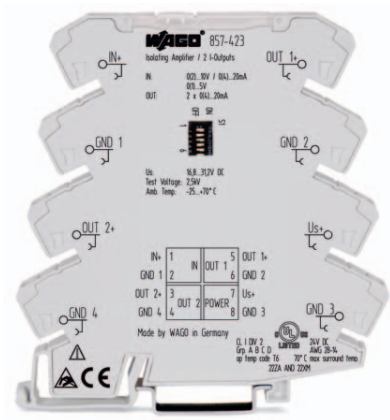

Short description:

The 857-423 Signal Splitter is used to convert, amplify, filter and electrically isolate analog standard signals. The device has a 3-way isolation with a 2.5kV test voltage. The signal splitter transmits the configurable input signal (0 - 10V, 2 - 10V, 0 - 20mA, 4 - 20mA, 0 - 5V or 1 - 5V) in two analog current outputs that can be set independently of one another between 0 - 20mA and 4 - 20mA. Measurement range switching is calibrated. The device is supplied with 24VDC, which can be commoned using lateral push-in type jumper bars in a quick and cost effective way. A green LED on the front panel indicates normal operation. The signal splitter meets the requirements for safe isolation of input, output and supply circuits with 2.5kV test voltage according to EN 61140.

Description	Item No.	Pack. Unit
Signal splitter with 2 configurable current outputs	857-423	1
Accessories		
General accessories	see pages 222 - 223	
Approvals		
Shipbuilding	Ⓢ (pending)	
ANSI/ISA 12.12.01	Class I, Div. 2, Grp. ABCD, T4	
Conformity marking	CE	
General Specifications		
Dimensions (mm) W x H x L	6 x 96 x 94	
Wire connection	Height from upper-edge of DIN 35 rail CAGE CLAMP®S	
Cross sections	solid: 0.08 mm² ... 2.5 mm² / AWG 28 ... 12	
	fine-stranded: 0.34 mm² ... 2.5 mm² / AWG 22 ... 12	
Stripped lengths	9 ... 10 mm / 0.37 in	

Technical Data	
Configuration	DIP switch
Input signal	0 ... 20 mA, 4 ... 20 mA, 0 ... 5 V, 0 ... 10 V, 2 ... 10 V, 1 ... 5 V (calibrated switchable)
Input resistance	≤ 50 Ω (In = mA) ≥ 100 kΩ (In = V)
Output signal	2 x 0(4) ... 20 mA (calibrated switchable)
Load impedance	2 x 300 Ω
Max. operating frequency	100 Hz / 1 kHz (switchable via DIP switch)
Response time (T _{10/90})	< 3.5 ms / < 300 μs
Voltage supply V _N	24 V DC
Supply voltage range	16.8 V ... 31.2 V
Current input at 24 V DC	< 35 mA
Transmission error	< 0.1 % of the full scale value
Temperature coefficient	0.01 % /K
Test voltage	
(input/output/supply)	2.5 kV AC, 50 Hz, 1 min
Ambient operating temperature	-25 °C ... +70 °C
Storage temperature	-40 °C ... +85 °C

DIP Switch Adjustability

● = ON

857-423

DIP Switch S1 (6-fold)

Input Signal			Max. Operating Frequency		Output 1		Output 2	
1	2	3	4		5		6	
●			0 ... 20 mA		$f_{max.}$ approx. 1 kHz		0 ... 20 mA	0 ... 20 mA
●		●	4 ... 20 mA	●	$f_{max.}$ < 100 Hz	●	4 ... 20 mA	● 4 ... 20 mA
	●		0 ... 10 V					
	●	●	2 ... 10 V					
			0 ... 5 V					
		●	1 ... 5 V					

Default Settings

- Input: 0 ... 20 mA
- Output 1: 0 ... 20 mA
- Output 2: 0 ... 20 mA
- Max. Operating Frequency: < 100 Hz

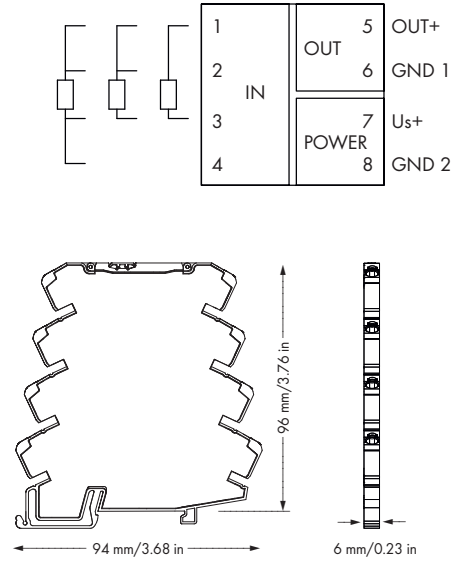
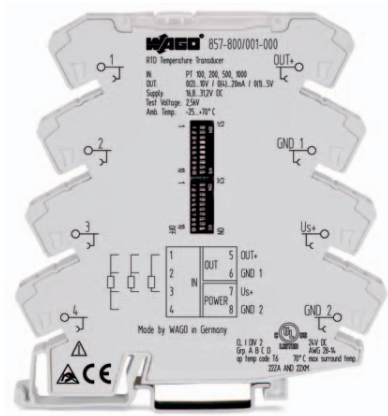

Short description:

The 857-800 Temperature Transducer is suitable for the connection of Pt100, Pt200, Pt500 and Pt1000 sensors in 2-, 3- and 4-conductor connection technology. On the input side, 0 - 1 kΩ or 0 - 4.5 kΩ resistance values can be measured. On the output side, the Pt100 temperature transducer converts the temperature signal into an analog standard signal. The following signals are available: 0 - 20mA, 4 - 20mA, 0 - 10V, 2 - 10V, 0 - 5V, 1 - 5V, 0 - 10mA and 2 - 10mA. The device has a 3-way isolation with a 2.5kV test voltage. The devices can be configured via DIP switches that are accessible from the side of the housing. Measurement range switching is calibrated. The device is supplied with 24VDC, which can be commoned using lateral push-in type jumper bars in a quick and cost effective way.

A green LED on the front panel indicates normal operation. The temperature transducer meets the requirements for safe isolation of input, output and supply circuits with 2.5kV test voltage according to EN 61140.

Description	Item No.	Pack. Unit
Temperature transducer for Pt100, Pt200, Pt500 und Pt1000 as well as resistors 0 ... 1 kΩ; 0 ... 4.5 kΩ	857-800	1
Accessories		
General accessories	see pages 222 - 223	
Approvals		
Shipbuilding	☉ (pending)	
☉-ANSI/ISA 12.12.01	Class I, Div. 2, Grp. ABCD, T4	
Conformity marking	CE	
General Specifications		
Dimensions (mm) W x H x L	6 x 96 x 94	
	Height from upper-edge of DIN 35 rail	
Wire connection	CAGE CLAMP®S	
Cross sections	solid: 0.08 mm ² ... 2.5 mm ² / AWG 28 ... 12	
	fine-stranded: 0.34 mm ² ... 2.5 mm ² / AWG 22 ... 12	
Stripped lengths	9 ... 10 mm / 0.37 in	

Technical Data	
Configuration	DIP switch
Input signal	PT sensors and resistors
Output signal	0 ... 20 mA, 4 ... 20 mA, 0 ... 10 V, 2 ... 10 V, 0 ... 5 V, 1 ... 5 V, 0 ... 10 mA, 2 ... 10 mA
Load impedance	≤ 600 Ω (Out = mA) ≥ 2 kΩ (Out = V)
Step response	180 ms (360 ms at 3-wire)
Voltage supply V _N	24 V DC
Supply voltage range	16.8 V ... 31.2 V
Current input at 24 V DC	< 40 mA
Sensor types	Pt100, Pt200, Pt500, Pt1000
Sensor connection	2-wire, 3-wire, 4-wire (switchable)
Temperature range	-200 °C ... +850 °C
Resistor input	0 ... 1 kΩ , 0 ... 4.5 kΩ
Transmission error	≤ 0.1 % at max. measuring span
Transmission error of set measuring span	((10 K / set measuring span [K]) + 0.1) %
Temperature coefficient	0.02 % /K
Min. measuring span	50 K (50 Ω) (configurable)
Test voltage (input/output/supply)	2.5 kV AC, 50 Hz, 1 min
Ambient operating temperature	-25 °C ... +70 °C
Storage temperature	-40 °C ... +85 °C

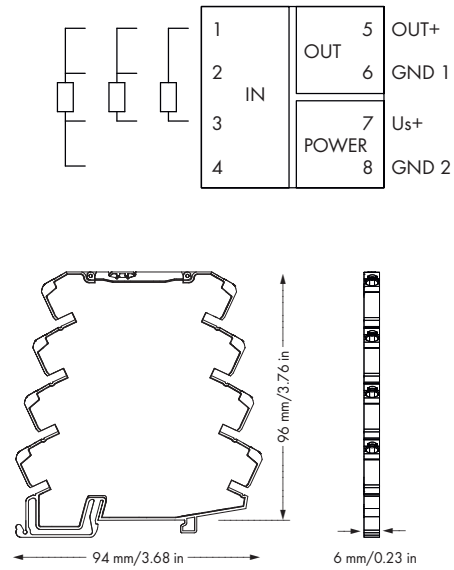
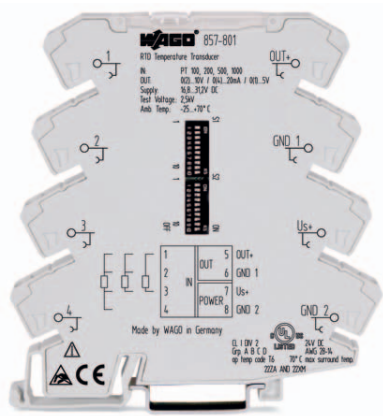

Short description:

The 857-801 Temperature Transducer is suitable for the connection of Pt100, Pt200, Pt500 and Pt1000 sensors in 2-, 3- and 4-conductor connection technology. On the input side, 0 - 1 kΩ or 0 - 4.5 kΩ resistance values can be measured. On the output side, the Pt100 temperature transducer converts the temperature signal into an analog standard signal. The following signals are available: 0 - 20mA, 4 - 20mA, 0 - 10V, 2 - 10V, 0 - 5V, 1 - 5V, 0 - 10mA and 2 - 10mA. The device has a 3-way isolation with a 2.5kV test voltage. The devices can be configured both via DIP switches that are accessible from the side of the housing and using a FDT/DTM software. The software offers additional setting options such as additional types of sensors at the input or inversion of the analog output. Measurement range switching is calibrated.

The device is supplied with 24VDC, which can be commoned using lateral push-in type jumper bars in a quick and cost effective way. A green LED on the front panel indicates normal operation. The temperature transducer meets the requirements for safe isolation of input, output and supply circuits with 2.5kV test voltage according to EN 61140.

Description	Item No.	Pack. Unit
Temperature transducer for Pt100, Pt200, Pt500 und Pt1000 * as well as resistors 0 ... 1 kΩ; 0 ... 4.5 kΩ	857-801	1
Accessories		
Configuration software	- 759-370 FDT Frame Application - DTM (Device Tool Manager) Download: see www.wago.com	
WAGO USB Service Cable	750-923	
General accessories	see pages 222 - 223	
Approvals		
Shipbuilding	Ⓢ (pending)	
Ⓢ Ⓢ ANSI/ISA 12.12.01	Class I, Div. 2, Grp. ABCD, T4	
Conformity marking	CE	
General Specifications		
Dimensions (mm) W x H x L	6 x 96 x 94 Height from upper-edge of DIN 35 rail	
Wire connection	CAGE CLAMP®S	
Cross sections	solid: 0.08 mm² ... 2.5 mm² / AWG 28 ... 12 fine-stranded: 0.34 mm² ... 2.5 mm² / AWG 22 ... 12	
Stripped lengths	9 ... 10 mm / 0.37 in	

Technical Data	
Configuration	DIP switch or via software
Input signal	PT sensors and resistors
Output signal	0 ... 20 mA, 4 ... 20 mA, 0 ... 10 V, 2 ... 10 V, 0 ... 5 V, 1 ... 5 V, 0 ... 10 mA, 2 ... 10 mA
Load impedance	≤ 600 Ω (Out = mA) ≥ 2 kΩ (Out = V)
Step response	180 ms (360 ms at 3-wire)
Voltage supply V _N	24 V DC
Supply voltage range	16.8 V ... 31.2 V
Current input at 24 V DC	< 40 mA
Sensor types	Pt100, Pt200, Pt500, Pt1000 *
Sensor connection	2-wire, 3-wire, 4-wire (switchable)
Temperature range	-200 °C ... +850 °C
Resistor input	0 ... 1 kΩ , 0 ... 4.5 kΩ
Transmission error	≤ 0.1 % at max. measuring span
Transmission error of set measuring span	((10 K / set measuring span [K]) + 0.1) %
Temperature coefficient	0.02 % /K
Min. measuring span	50 K (50 Ω) (configurable)
Test voltage	(input/output/supply) 2.5 kV AC, 50 Hz, 1 min
Ambient operating temperature	-25 °C ... +70 °C
Storage temperature	-40 °C ... +85 °C
(* Setting of other types of sensors as well as output signal inversion using the configuration software)	

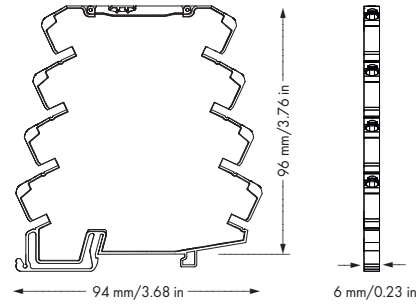
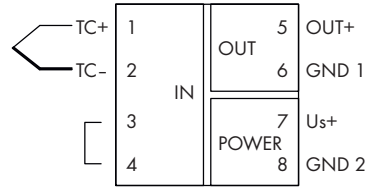
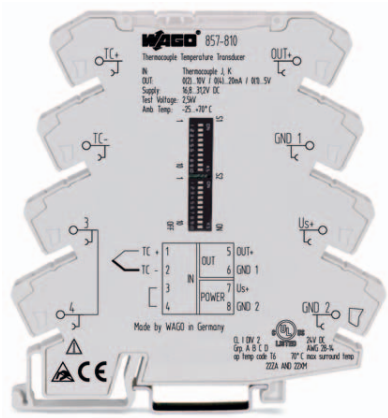

Short description:

The 857-810 Thermocouple Temperature Transducer is suitable for the connection of type J and K thermocouples. On the output side, the thermocouple temperature transducer converts the temperature signal into an analog standard signal. The following signals are available: 0 - 20mA, 4 - 20mA, 0 - 10V, 2 - 10V, 0 - 5V, 1 - 5V, 0 - 10mA and 2 - 10mA. The device has a 3-way isolation with a 2.5kV test voltage. It can be configured via DIP switches that are accessible from the side of the housing. Measurement range switching is calibrated. The device is supplied with 24VDC, which can be commoned using lateral push-in type jumper bars in a quick and cost effective way.

A green LED on the front panel indicates normal operation. The temperature transducer meets the requirements for safe isolation of input, output and supply circuits with 2.5kV test voltage according to EN 61140.

Description	Item No.	Pack. Unit
Temperature transducer for thermocouples of types J and K	857-810	1
Accessories		
General accessories	see pages 222 - 223	
Approvals		
Shipbuilding	Ⓢ (pending)	
Ⓢ-ANSI/ISA 12.12.01	Class I, Div. 2, Grp. ABCD, T4	
Conformity marking	CE	
General Specifications		
Dimensions (mm) W x H x L	6 x 96 x 94 Height from upper-edge of DIN 35 rail	
Wire connection	CAGE CLAMP®S	
Cross sections	solid: 0.20 mm ² ... 2.5 mm ² / AWG 24 ... 12	
	fine-stranded: 0.34 mm ² ... 2.5 mm ² / AWG 22 ... 12	
Stripped lengths	9 ... 10 mm / 0.37 in	

Technical Data	
Configuration	DIP switch
Input signal	Thermocouples
Output signal	0 ... 20 mA, 4 ... 20 mA, 0 ... 10 V, 2 ... 10 V, 0 ... 5 V, 1 ... 5 V, 0 ... 10 mA, 2 ... 10 mA
Load impedance	≤ 600 Ω (Out = mA) ≥ 2 kΩ (Out = V)
Step response	60 ms / 120 ms with cold junction compensation
Voltage supply V _N	24 V DC
Supply voltage range	16.8 V ... 31.2 V
Current input at 24 V DC	< 40 mA
Sensor types	Thermocouples of types J and K
Temperature range	Type J: -150 °C ... +1200 °C Type K: -150 °C ... +1350 °C
Cold junction compensation	on / off (default: on)
Cold junction error	3 K (typ. 2 K)
Transmission error	≤ 0.1 % at max. measuring span (Typ J, K)
Transmission error of set measuring span	(150 K / set measuring span [K]) %
Temperature coefficient	0.04 % /K
Min. measuring span	100 K (configurable)
Test voltage (input/output/supply)	2.5 kV AC, 50 Hz, 1 min
Ambient operating temperature	-25 °C ... +70 °C
Storage temperature	-40 °C ... +85 °C

DIP Switch Adjustability

● = ON

857-810

DIP Switch S1

Cold junction compensation		Sensor type		Output signal					Measuring range underflow	Measuring range overflow	Wire break
1		2	3	4	5	6	7	8			
	on			J			0 ... 20 mA		Lower limit of output range -5 %	Upper limit of output range +2.5 %	Upper limit of output range 5 %
●	off	●		K	●		4 ... 20 mA		Lower limit of output range	Upper limit of output range +2.5 %	Upper limit of output range 5 %
						●	0 ... 10 mA	●	Lower limit of output range	Upper limit of output range +2.5 %	Upper limit of output range 5 %
						●	2 ... 10 mA		Lower limit of output range	Upper limit of output range	Upper limit of output range 5 %
						●	0 ... 10 V		Lower limit of output range	Upper limit of output range	Upper limit of output range 5 %
						●	2 ... 10 V	●	Lower limit of output range	Upper limit of output range	Upper limit of output range 5 %
						●	0 ... 5 V	●	Lower limit of output range	Upper limit of output range	Lower limit of output range
						●	1 ... 5 V	●	Lower limit of output range	Upper limit of output range	Lower limit of output range

According to Namur NE 43

DIP Switch S2

Start temperature						End temperature																								
1	2	3	4	°C	°F	5	6	7	8	9	10	°C	°F	5	6	7	8	9	10	°C	°F	5	6	7	8	9	10	°C	°F	
				-200	-328							0	32						●	225	437							●	625	1157
●				-175	-283	●						10	50	●					●	250	482	●						●	650	1202
	●			-150	-283		●					20	68		●				●	275	527		●					●	675	1247
		●		-125	-193			●				30	86			●			●	300	572			●				●	700	1292
●			●	-100	-148	●		●				40	104	●		●			●	325	617	●		●				●	725	1337
	●	●		-90	-130		●	●				50	122		●	●	●		●	350	662		●	●				●	750	1382
●	●	●		-80	-112	●	●	●				60	140	●	●	●	●		●	375	707	●	●	●				●	775	1427
			●	-70	-94				●			70	158				●	●	●	400	752				●			●	800	1472
●			●	-60	-76	●		●				80	176	●		●	●		●	425	797	●		●				●	825	1517
	●	●	●	-50	-58		●	●	●			90	194		●	●	●	●	●	450	842		●	●	●			●	850	1562
●	●	●	●	-40	-40	●	●	●	●			100	212	●	●	●	●	●	●	475	887	●	●	●	●			●	875	1607
		●	●	-30	-22			●	●			125	257			●	●	●	●	500	932			●	●	●		●	900	1652
●	●	●	●	-20	-4	●	●	●	●			150	302	●	●	●	●	●	●	525	977	●	●	●	●	●		●	925	1697
	●	●	●	-10	14		●	●	●			175	347		●	●	●	●	●	550	1022		●	●	●	●		●	950	1742
●	●	●	●	0	32	●	●	●	●			200	392	●	●	●	●	●	●	575	1067	●	●	●	●	●		●	975	1787
														●	●	●	●	●	●	600	1112	●	●	●	●	●		●	1000	1832

The minimum distance from the start temperature to the end temperature may not fall short of 100K degrees on the Celsius (C) scale or 212K degrees on the Fahrenheit (F) scale.

Default settings

In delivery status all DIP switches are in the position "OFF".

- Cold junction compensation "On"
- Termocouple of type J
- Start temperature 0 °C
- End temperature 1000 °C
- 0 ... 20 mA
- Measuring range underflow 0 mA
- Measuring range overflow 20.5 mA
- Wire break 21 mA

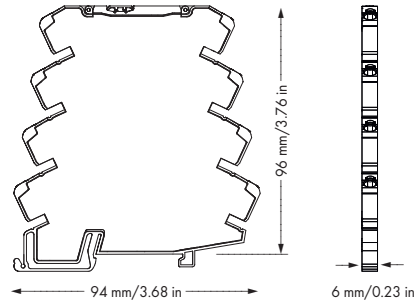
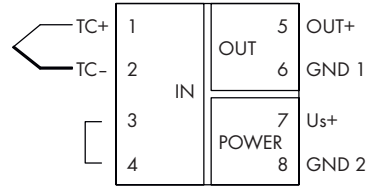
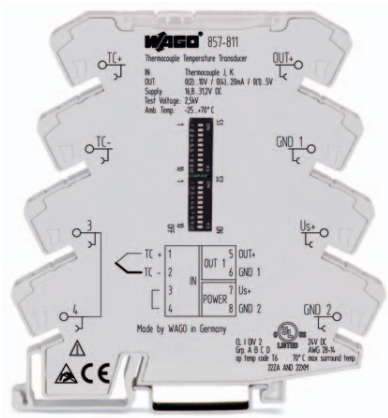

Short description:

The 857-811 Thermocouple Temperature Transducer is suitable for the connection of type J and K thermocouples. On the output side, the thermocouple temperature transducer converts the temperature signal into an analog standard signal. The following signals are available: 0 - 20mA, 4 - 20mA, 0 - 10V, 2 - 10V, 0 - 5V, 1 - 5V, 0 - 10mA and 2 - 10mA. The device has a 3-way isolation with a 2.5kV test voltage. It can be configured both via DIP switches that are accessible from the side of the housing and using a FDT/DTM software. The software offers additional setting options such as additional types of sensors at the input or inversion of the analog output. The device is supplied with 24VDC, which can be commoned using lateral push-in type jumper bars in a quick and cost effective way.

A green LED on the front panel indicates normal operation. The temperature transducer meets the requirements for safe isolation of input, output and supply circuits with 2.5kV test voltage according to EN 61140.

Description	Item No.	Pack. Unit
Temperature transducer for thermocouples of types J and K *	857-811	1
Accessories		
Configuration software	- 759-370 FDT Frame Application - DTM (Device Tool Manager) Download: see www.wago.com	
WAGO USB Service Cable	750-923	
General accessories	see pages 222 - 223	
Approvals		
Shipbuilding	Ⓢ (pending)	
Ⓢ Ⓢ- ANSI/ISA 12.12.01	Class I, Div. 2, Grp. ABCD, T4	
Conformity marking	CE	
General Specifications		
Dimensions (mm) W x H x L	6 x 96 x 94 Height from upper-edge of DIN 35 rail	
Wire connection	CAGE CLAMP®S	
Cross sections	solid: 0.08 mm ² ... 2.5 mm ² / AWG 28 ... 12 fine-stranded: 0.34 mm ² ... 2.5 mm ² / AWG 22 ... 12	
Stripped lengths	9 ... 10 mm / 0.37 in	

Technical Data	
Configuration	DIP switch or via software
Input signal	Thermocouples
Output signal	0 ... 20 mA, 4 ... 20 mA, 0 ... 10 V, 2 ... 10 V, 0 ... 5 V, 1 ... 5 V, 0 ... 10 mA, 2 ... 10 mA
Load impedance	≤ 600 Ω (Out = mA) ≥ 2 kΩ (Out = V)
Step response	60 ms / 120 ms with cold junction compensation
Voltage supply V _N	24 V DC
Supply voltage range	16.8 V ... 31.2 V
Current input at 24 V DC	< 40 mA
Sensor types	Thermocouples of types J and K *
Temperature range	Type J: -150 °C ... +1200 °C Type K: -150 °C ... +1350 °C
Cold junction compensation	on / off (default: on)
Cold junction error	3 K (typ. 2 K)
Transmission error	≤ 0.1 % at max. measuring span (Typ J, K)
Transmission error of set measuring span	(150 K / set measuring span [K]) %
Temperature coefficient	0.04 % /K
Min. measuring span	100 K (configurable)
Test voltage (input/output/supply)	2.5 kV AC, 50 Hz, 1 min
Ambient operating temperature	-25 °C ... +70 °C
Storage temperature	-40 °C ... +85 °C
(* Setting of other types of sensors as well as output signal inversion using the configuration software)	

JUMPFLEX® Transducers

Millivolt transducer; Records all mV signals ranging from -100 mV to +100 mV; 0 mV ... 1000 mV. Application: Recording of lambda probes

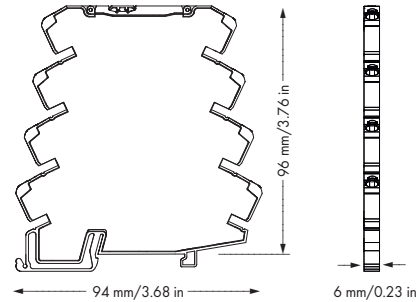
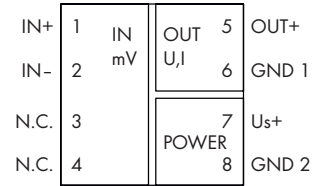
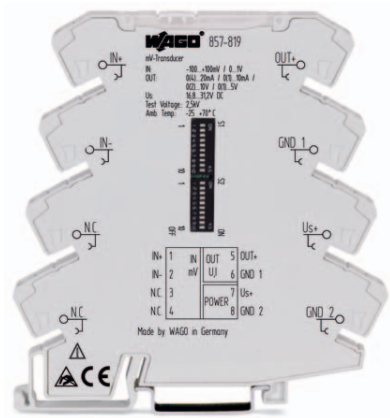

Short description:

The 857-819 Millivolt Transducer converts input millivolt signals into an analog standard signal on the output side. The following signals are available: 0 - 20mA, 4 - 20mA, 0 - 10V, 2 - 10V, 0 - 5V, 1 - 5V, 0 - 10mA and 2 - 10mA. The device has a 3-way isolation with a 2.5kV test voltage. The transducer can be configured either using FDT/DTM software or via DIP switches that are accessible from the side of the housing. The software offers additional setting options such as the ability to invert the output signal. The device is supplied with 24VDC, which can be commoned using lateral push-in type jumper bars in a quick and cost effective way.

A green LED on the front panel indicates normal operation. The millivolt transducer meets the requirements for safe isolation of input, output and supply circuits with 2.5kV test voltage according to EN 61140.

Description	Item No.	Pack. Unit
Millivolt transducer, with millivolt input as well as current and voltage output	857-819	1
Accessories		
Configuration software	- 759-370 FDT Frame Application - DTM (Device Tool Manager) Download: see www.wago.com	
WAGO USB Service Cable	750-923	
General accessories	see pages 222 - 223	
Approvals		
Shipbuilding	Ⓢ (pending)	
Ⓢ Ⓢ ANSI/ISA 12.12.01	Class I, Div. 2, Grp. ABCD, T4	
Conformity marking	CE	
General Specifications		
Dimensions (mm) W x H x L	6 x 96 x 94	
Wire connection	Height from upper-edge of DIN 35 rail CAGE CLAMP®S	
Cross sections	solid: 0.08 mm² ... 2.5 mm² / AWG 28 ... 12	
	fine-stranded: 0.34 mm² ... 2.5 mm² / AWG 22 ... 12	
Stripped lengths	9 ... 10 mm / 0.37 in	

Technical Data	
Configuration	DIP switch or configuration software
Input signal	-100 mV ... +100 mV, 0 mV ... 200 mV, 0 mV ... 300 mV, 0 mV ... 1000 mV (in 100 mV increments)
Max. input signal	30 V
Output signal	0 ... 20 mA, 4 ... 20 mA, 0 ... 10 V, 2 ... 10 V, 0... 5 V, 1 ... 5 V, 0 ... 10 mA, 2 ... 10 mA
Load impedance	≤ 600 Ω (I output) ≥ 2 kΩ (U output)
Step response	50 ms
Voltage supply V _N	24 V DC
Supply voltage range	16.8 V ... 31.2 V
Transmission error	< 0.1 % of upper range value
Temperature coefficient	0.01 %/K
Min. measuring span	10 mV (configurable)
Test voltage (input/output/supply)	2.5 kV AC, 50 Hz, 1 min
Ambient operating temperature	-25 °C ... +70 °C
Storage temperature	-40 °C ... +85 °C

DIP Switch Adjustability

● = ON

857-819

Start value																								
DIP S1																								
1	2	3	4	5	6	7	mV	1	2	3	4	5	6	7	mV	1	2	3	4	5	6	7	mV	
●							-100	●	●						-34	●	●	●						34
	●						-98			●					-32	●	●							36
●	●						-96	●	●						-30	●	●							38
		●					-94		●	●					-28	●	●							40
●		●					-92	●	●	●					-26	●	●							42
	●	●					-90				●				-24	●	●							44
●	●	●					-88	●	●		●				-22	●	●							46
			●				-86		●						-20	●	●							48
●			●				-84	●	●						-18	●	●							50
	●		●				-82			●					-16	●	●							52
●	●		●				-80	●	●		●				-14	●	●							54
		●	●				-78		●	●					-12	●	●							56
●	●	●	●				-76	●	●	●					-10	●	●							58
		●	●				-74				●				-8	●	●							60
●	●	●	●				-72	●	●		●				-6	●	●							62
				●			-70		●						-4	●	●							64
●				●			-68	●	●		●				-2	●	●							66
	●			●			-66			●					0	●	●							68
●	●			●			-64	●	●		●				2	●	●							70
		●		●			-62		●	●					4	●	●							72
●	●			●			-60	●	●		●				6	●	●							74
		●		●			-58			●	●				8	●	●							76
●	●			●			-56	●	●		●				10	●	●							78
		●		●			-54		●	●					12	●	●							80
●	●			●			-52	●	●		●				14	●	●							82
		●		●			-50			●	●				16	●	●							84
●	●			●			-48	●	●		●				18	●	●							86
		●		●			-46		●	●					20	●	●							88
●	●			●			-44	●	●		●				22	●	●							90
		●		●			-42			●	●				24	●	●							92
●	●			●			-40	●	●						26	●	●							94
		●		●			-38			●	●				28	●	●							96
●	●			●			-36	●	●						30	●	●							98
		●		●						●	●				32	●	●							100

End value																															
DIP S1				DIP S2				DIP S1				DIP S2				DIP S1				DIP S2											
8	9	10	1	2	3	4	mV	8	9	10	1	2	3	4	mV	8	9	10	1	2	3	4	mV	8	9	10	1	2	3	4	mV
●							-100	●	●						-34	●	●							34	●	●			100		
	●						-98			●					-32	●	●							36	●	●			200		
●	●						-96	●	●						-30	●	●						38	●	●			300			
		●					-94		●	●					-28	●	●						40	●	●			400			
●	●						-92	●	●						-26	●	●						42	●	●			500			
		●					-90			●					-24	●	●						44	●	●			600			
●	●						-88	●	●						-22	●	●						46	●	●			700			
		●					-86		●	●					-20	●	●						48	●	●			800			
●	●						-84	●	●						-18	●	●						50	●	●			900			
		●					-82			●					-16	●	●						52	●	●			1000			
●	●						-80	●	●						-14	●	●						54								
		●					-78		●	●					-12	●	●						56								
●	●						-76	●	●						-10	●	●						58								
		●					-74			●					-8	●	●						60								
●	●						-72	●	●						-6	●	●						62								
		●					-70		●						-4	●	●						64								
●	●						-68	●	●						-2	●	●						66								
		●					-66			●					0	●	●						68								
●	●						-64	●	●						2	●	●						70								
		●					-62		●	●					4	●	●						72								
●	●						-60	●	●						6	●	●						74								
		●					-58			●	●				8	●	●						76								
●	●						-56	●	●						10	●	●						78								
		●					-54		●	●					12	●	●						80								
●	●						-52	●	●						14	●	●						82								
		●					-50			●	●				16	●	●						84								
●	●						-48	●	●						18	●	●						86								
		●					-46		●	●					20	●	●						88								
●	●						-44	●	●						22	●	●						90								
		●					-42			●	●				24	●	●						92								
●	●						-40	●	●						26	●	●						94								
		●					-38			●	●				28	●	●						96								
●	●						-36	●	●						30	●	●						98								
		●								●	●				32	●	●						100								

DIP Switch S2

Output Signal		Measuring Range Underflow	Measuring Range Overflow	
6	7	8	9	10
●		0 ... 20 mA	Lower limit of output range -5 %	Upper limit of output range +2.5 %
	●	4 ... 20 mA		
●		0 ... 10 mA	Lower limit of output range	Upper limit of output range +2.5 %
	●	2 ... 10 mA		
●		0 ... 10 V	Lower limit of output range	Upper limit of output range
	●	2 ... 10 V		
●		0 ... 5 V	Lower limit of output range	Upper limit of output range
	●	1 ... 5 V		

Default settings

In delivery status all DIP switches are in the position "OFF".

- Measuring range 0 ... 100 mV
- Output range 0 ... 20 mA
- Measuring range overflow 20.5 mA
- Measuring range underflow 0 mA

According to Namur NE 43

JUMPFLEX® Transducers

Threshold value switch with analog input and changeover relay output

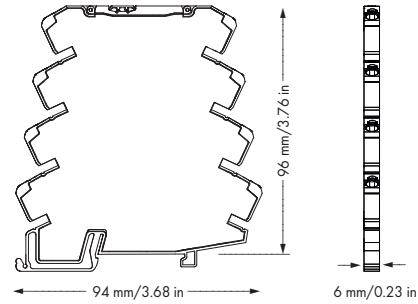
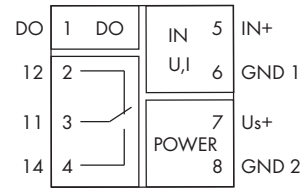
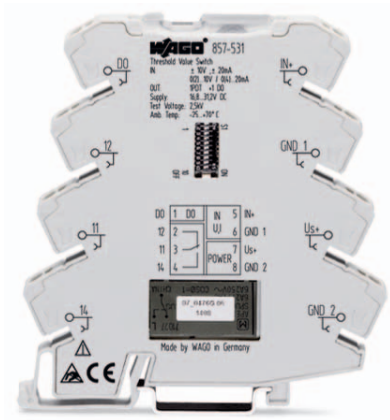

Short description:

The threshold value switch for analog signals monitors analog standard signals and reports signals exceeding a preset threshold. It is equipped with an analog input and a changeover relay output. The device features a 24VDC nominal voltage supply. In addition, the device has a digital output (DO) to indicate other conditions, such as a range overflow or underflow. The threshold value switch can be configured via DIP switches and teach-in function via push-slider switch. Configuration via FDT/DTM software is also possible.

Description	Item No.	Pack. Unit
Threshold value switch with analog input, changeover relay output and digital output	857-531	1
Accessories		
Configuration software	- 759-370 FDT Frame Application - DTM (Device Tool Manager) Download: see www.wago.com	
WAGO USB Service Cable	750-923	
General accessories	see pages 222 - 223	
Approvals		
Shipbuilding	Ⓢ (pending)	
Ⓢ Ⓢ ANSI/ISA 12.12.01	Class I, Div. 2, Grp. ABCD, T4	
Conformity marking	CE	
General Specifications		
Dimensions (mm) W x H x L	6 x 96 x 94	
	Height from upper-edge of DIN 35 rail	
Wire connection	CAGE CLAMP®S	
Cross sections	solid: 0.08 mm² ... 2.5 mm² / AWG 28 ... 12	
	fine-stranded: 0.34 mm² ... 2.5 mm² / AWG 22 ... 12	
Stripped lengths	9 ... 10 mm / 0.37 in	

Technical Data	
Configuration	DIP switch, teach-in function, configuration software
Input signal	-10...+10 V, -20...+20 mA, 0...+30 V
Max. input signal	(31.2 V (U _{IN}) 100 mA (I _{IN}))
Input resistance	≤ 200 Ω (I input) > 100 kΩ (U input)
Output - Relay	
Contact type	1 changeover contact
Max. switching voltage	250 V AC
Max. continuous current (terminal)	max. 6 A (to 60 °C), 3 A (60 to 70 °C)
Max. Switching power (resistive)	1250 VA AC
Switching threshold	1 bzw. 2 (adjustable)
Configurable rise and fall delay time	10 s (via DIP switch),
Output - Digital	
Max. switching voltage	Supply voltage
Max. continuous current	500 mA (to 60 °C) 100 mA (60 to 70 °C)
Supply voltage range	16.8 V ... 31.2 V
Test voltage	
(input/output/supply)	2.5 kV AC, 50 Hz, 1 min
Ambient operating temperature	-25 °C ... +70 °C
Storage temperature	-40 °C ... +85 °C

DIP Switch Adjustability

● = ON

857-531

DIP S1						
1	2	3	4	Input signal limits ± 0.25 V; ± 0.5 mA	5	Hysteresis
				± 10 V		5 mV; 10 µA
	●			0 ... 10 V	●	10 mV, 20 µA
		●		2 ... 10 V		
	●	●		0 ... 5 V		
			●	1 ... 5 V		
	●		●	± 5 V		
		●	●	0 ... 15 V		
	●	●	●	0 ... 30 V		
●				± 20 mA		
●	●			0 ... 20 mA		
●		●		4 ... 20 mA		
●	●	●		0 ... 10 mA		
●			●	2 ... 10 mA		
●	●		●	± 10 mA		

DIP S1							
6	7	8	Configurable rise/ fall delay time in sec.	9	Measuring range overflow indication	10	DO
			0		DO Ub switched		not active
●			1	●	DO GND switched	●	active
	●		2				
●	●		3				
		●	4				
●		●	5				
	●	●	8				
●	●	●	10				

"Teach-In" Switch Operation

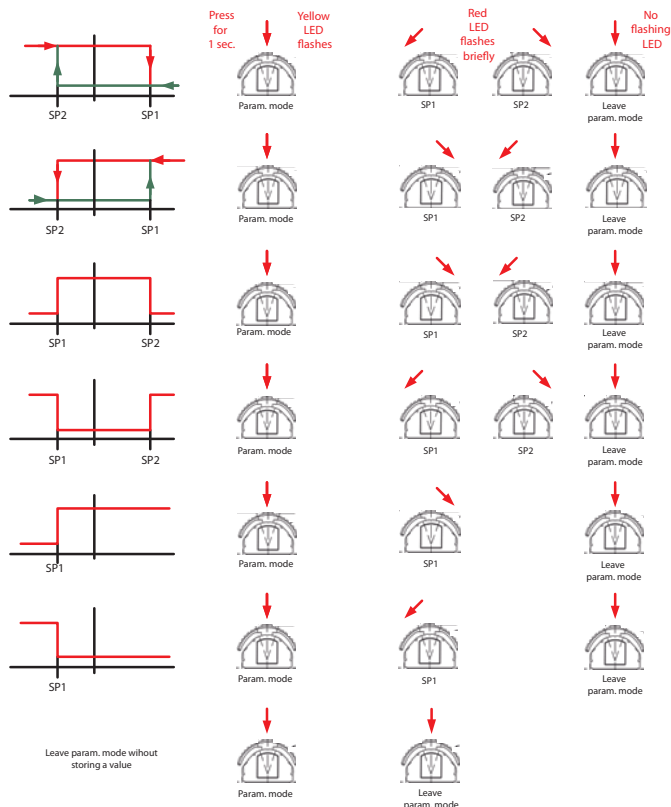

Default settings
 In delivery status all DIP switches are in the position "OFF".

- Input range: ± 10 V
- Hysteresis: 5 mV
- Configurable rise/fall delay time: 0 s
- DO: not active

3 JUMPFLEX® 8-Channel Adapter for System Wiring

222

8-channel adapter
with 16-pin ribbon cable connector
Analog

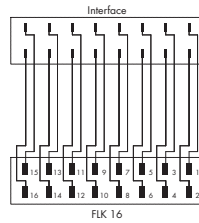
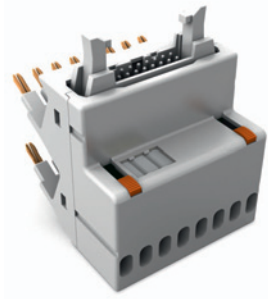
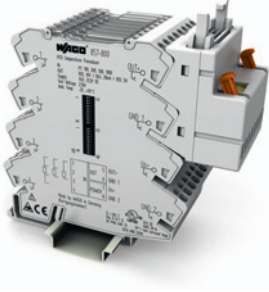

Description	Item No.	Pack. unit
JUMPFLEX® 8-channel adapter for system wiring	857-980	1
Technical Data		
Connection type, signal level	16-pin ribbon cable connector acc. to DIN 41651	
Performance level	3	
Contact resistance	≤ 20 mΩ	
Current carrying capacity	1 A	
Test voltage	500 V / 50 Hz / 1 min.	
Overvoltage category	III	
Degree of pollution	2	
Accessories	WAGO ribbon cable on request	

Accessories, 857 Series

Push-in type jumper bar



Commoning



Description		Item No.	Pack. Unit
Push-in type jumper bars, light gray, insulated, 18 A	2-way	859-402	200 (8x25)
	3-way	859-403	200 (8x25)
	4-way	859-404	200 (8x25)
	5-way	859-405	200 (8x25)
	6-way	859-406	100 (4x25)
	7-way	859-407	100 (4x25)
	8-way	859-408	100 (4x25)
	9-way	859-409	100 (4x25)
	10-way	859-410	100 (4x25)
	Item no. suffix for colored push-in type jumper bars	yellow	... /000-029
red		... /000-005	
blue		... /000-006	

WMB Multi marking system



Marking



Description		Item No.	Pack. Unit
WMB Multi marking system	plain	793-501	5 cards
Marking software and printer/plotter see Section 8			
Marking	1 ... 10 (10x)	793-502	5 cards
	11 ... 20 (10x)	793-503	5 cards
	21 ... 30 (10x)	793-504	5 cards
	31 ... 40 (10x)	793-505	5 cards
	41 ... 50 (10x)	793-506	5 cards
	1 ... 50 (2x)	793-566	5 cards
10 strips with 10 markers, white with black printing			

Operating tool



Wire connection



WAGO USB service cable



Configuration



Description		Item No.	Pack. Unit
Operating tool, with partially insulated shaft	Type 2, blade (3.5 x 0.5) mm	210-720	1
WAGO USB service cable		750-923	1

3 Pluggable Modules - Temperature Transducers

	Input: Pt100 type RTD element 2-wire, with error output for broken wire and short circuit of sensor Module width 20 mm / 0.787 in	Input: Pt100 type RTD element 3-wire, with error output for broken wire and short circuit of sensor Module width 20 mm / 0.787 in
--	--	--

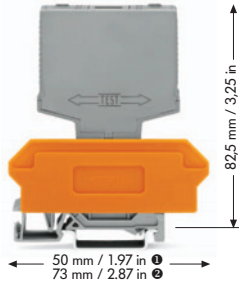

Other temperature ranges contact factory.
 LED indication of broken wire or short circuit
 WSB marker card

- Marking 1 ... 10; Item No.: 209-702
- Marking 1, 2, 3, 0V, +UB, OUT, ERR., 0V; Item No.: 249-622
- Marking 1, 2, 0V, +UB, OUT, ERR., 0V; Item No.: 249-623

5 cards, each containing 10 strips with 10 markers

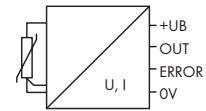
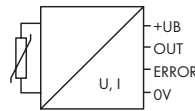

Description	Output	Item No.	Pack. Unit	Output	Item No.	Pack. Unit
Temperature transducer	0 - 10 V	286-860	1	0 - 10 V	286-870	1
	0 - 20 mA	286-861	1	0 - 20 mA	286-871	1
	4 - 20 mA	286-862	1	4 - 20 mA	286-872	1

Technical Data

Accessories see page 233

Accessories see page 233

Temperature range	0 °C ... 100 °C	0 °C ... 100 °C
Operating voltage	24 V DC (± 10 %)	24 V DC (± 10 %)
Nominal current	I _{BN} 30 mA	I _{BN} 30 mA
Load impedance	≥ 2 kΩ (Out = V) ≤ 500 Ω (Out = mA)	≥ 2 kΩ (Out = V) ≤ 500 Ω (Out = mA)
Error output - low upon error (fail safe)	V _B / max. 20 mA	V _B / max. 20 mA
Transmission error (measuring range)	≤ 0.3 %	≤ 0.3 %
Temperature coefficient	0.02 %/K	0.02 %/K
Ambient operating temperature	0 °C ... +55 °C	0 °C ... +55 °C
Electromagnetic compatibility test acc. to IEC 801-2/4/5	B acc. to EN 50082 T2 (E3.94)	B acc. to EN 50082 T2 (E3.94)

Accessories

Item No.

Pack. Unit

Item No.

Pack. Unit

Terminal block for pluggable modules, with 2-conductor terminal blocks, orange separator ①	22 mm / 0.866 in	280-638	1	22 mm / 0.866 in	280-638	1
with 4-conductor terminal blocks, orange separator ②	22 mm / 0.866 in	280-628	1	22 mm / 0.866 in	280-628	1
with 4-conductor terminal blocks, marker plate ③	25 mm / 0.984 in	280-764	1	25 mm / 0.984 in	280-764	1
wire range 0.08 mm ² ... 2.5 mm ² / AWG 28 ... 14; stripped length 8 ... 9 mm / 0.33 in						

	Input: Thermocouple J (Fe-CuNi) with error output for broken wire Module width 20 mm / 0.787 in	Input: Thermocouple K (NiCr-Ni) with error output for broken wire Module width 20 mm / 0.787 in
--	--	--

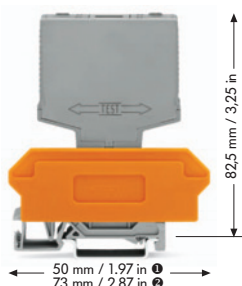

- Other temperature ranges contact factory.
LED indication of broken wire or short circuit
WSB marker card
- Marking 1 ... 10; Item No.: 209-702
 - Marking 1, 2, 3, 0V, +UB, OUT, ERR., 0V;
Item No.: 249-622
 - Marking 1, 2, 0V, +UB, OUT, ERR., 0V;
Item No.: 249-623
- 5 cards, each containing 10 strips with 10 markers

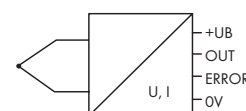
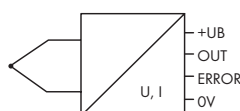

Description	Output	Item No.	Pack. Unit	Output	Item No.	Pack. Unit
Temperature transducer	0 - 10 V	286-863	1	0 - 10 V	286-864	1
	0 - 20 mA	286-865	1	0 - 20 mA	286-866	1
	4 - 20 mA	286-867	1	4 - 20 mA	286-868	1

Technical Data

Accessories see page 233

Accessories see page 233

Temperature range	0 °C ... 750 °C	0 °C ... 1000 °C
Operating voltage	24 V DC (± 10 %)	24 V DC (± 10 %)
Nominal current	$I_{BN} \leq 30 \text{ mA (Out = V)}$ $I_{BN} \leq 50 \text{ mA (Out = mA)}$	$I_{BN} \leq 30 \text{ mA (Out = V)}$ $I_{BN} \leq 50 \text{ mA (Out = mA)}$
Load impedance	$\geq 2 \text{ k}\Omega \text{ (Out = V)}$ $\leq 500 \Omega \text{ (Out = mA)}$	$\geq 2 \text{ k}\Omega \text{ (Out = V)}$ $\leq 500 \Omega \text{ (Out = mA)}$
Error output - low upon error (fail safe)	$V_B / \text{max. } 20 \text{ mA}$	$V_B / \text{max. } 20 \text{ mA}$
Transmission error (measuring range)	$\leq 2 \%$	$\leq 2 \%$
Temperature coefficient	0.02 %/K	0.02 %/K
Ambient operating temperature	0 °C ... +55 °C	0 °C ... +55 °C
Electromagnetic compatibility test acc. to IEC 801-2/4/5	B acc. to EN 50082 T2 (E3.94)	B acc. to EN 50082 T2 (E3.94)

Accessories

Accessories	Item No.	Pack. Unit	Item No.	Pack. Unit
Terminal block for pluggable modules, with 2-conductor terminal blocks, orange separator ①	22 mm / 0.866 in 280-638	1	22 mm / 0.866 in 280-638	1
with 4-conductor terminal blocks, orange separator ②	22 mm / 0.866 in 280-628	1	22 mm / 0.866 in 280-628	1
with 4-conductor terminal blocks, marker plate ③ wire range 0.08 mm ² ... 2.5 mm ² / AWG 28 ... 14; stripped length 8 ... 9 mm / 0.33 in	25 mm / 0.984 in 280-764	1	25 mm / 0.984 in 280-764	1

3 Pluggable Modules - Temperature Transducers

226

	Input: Pt100 type RTD element 2-wire, with error output for broken wire and short circuit of sensor -30 °C ... +150 °C Module width 20 mm / 0.787 in	Input: Pt100 type RTD element 3-wire, with error output for broken wire and short circuit of sensor -30 °C ... +150 °C Module width 20 mm / 0.787 in
--	---	---

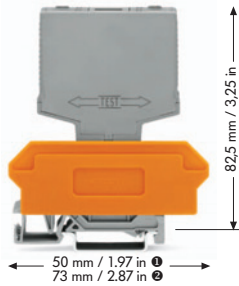

- Linear temperature curve
- Other temperature ranges contact factory.
- LED indication of broken wire or short circuit
- WSB marker card
 - Marking 1 ... 10; Item No.: 209-702
 - Marking 1, 2, 3, 0V, +UB, OUT, ERR., 0V; Item No.: 249-622
 - Marking 1, 2, 0V, +UB, OUT, ERR., 0V; Item No.: 249-623

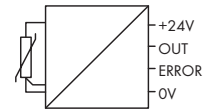
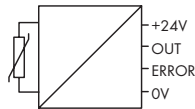

5 cards, each containing 10 strips with 10 markers

Description	Output	Item No.	Pack. Unit	Output	Item No.	Pack. Unit
Temperature transducer	0 ... 10 V	286-860/150-030	1	0 ... 10 V	286-870/150-030	1
	0 ... 20 mA	286-861/150-030	1	0 ... 20 mA	286-871/150-030	1
	4 ... 20 mA	286-862/150-030	1	4 ... 20 mA	286-872/150-030	1

Technical Data	Accessories see page 233	Accessories see page 233
Temperature range	-30 °C ... 150 °C	-30 °C ... 150 °C
Operating voltage	24 V DC (± 10 %)	24 V DC (± 10 %)
Nominal current	I_N 30 mA	I_N 30 mA
Load impedance	≥ 2 k Ω (Out = V) $\leq 500 \Omega$ (Out = mA)	≥ 2 k Ω (Out = V) $\leq 500 \Omega$ (Out = mA)
Error output (closed-current principle)	$V_B / 20$ mA	$V_B / 20$ mA
Transmission error (full scale)	≤ 0.2 %	≤ 0.2 %
Temperature coefficient	≤ 0.02 %/K	≤ 0.02 %/K
Ambient operating temperature	0 °C ... +55 °C	0 °C ... +55 °C
Electromagnetic compatibility test acc. to IEC 801-2/4/5	B acc. to EN 50082 T2 (E3.94)	B acc. to EN 50082 T2 (E3.94)

Accessories	Item No.	Pack. Unit	Item No.	Pack. Unit
Terminal block for pluggable modules, with 2-conductor terminal blocks, orange separator ①	22 mm / 0.866 in 280-638	1	22 mm / 0.866 in 280-638	1
with 4-conductor terminal blocks, orange separator ②	22 mm / 0.866 in 280-628	1	22 mm / 0.866 in 280-628	1
with 4-conductor terminal blocks, marker plate ③	25 mm / 0.984 in 280-764	1	25 mm / 0.984 in 280-764	1
wire range 0.08 mm ² ... 2.5 mm ² / AWG 28 ... 14; stripped length 8 ... 9 mm / 0.33 in				

	Input: Pt100 type RTD element 2-wire, with error output for broken wire and short circuit of sensor 0 °C ... +300 °C Module width 20 mm / 0.787 in	Input: Pt100 type RTD element 3-wire, with error output for broken wire and short circuit of sensor 0 °C ... +300 °C Module width 20 mm / 0.787 in
--	---	---

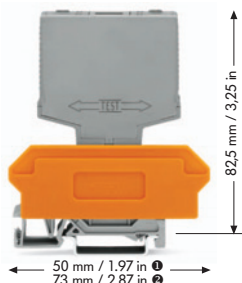

Linear temperature curve
 Other temperature ranges contact factory.
 LED indication of broken wire or short circuit
 WSB marker card

- Marking 1 ... 10; Item No.: 209-702
- Marking 1, 2, 3, 0V, +UB, OUT, ERR., 0V;
Item No.: 249-622
- Marking 1, 2, 0V, +UB, OUT, ERR., 0V;
Item No.: 249-623

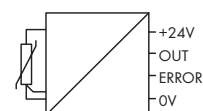
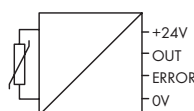

Description	Output	Item No.	Pack. Unit	Output	Item No.	Pack. Unit
Temperature transducer	0 ... 10 V	286-860/000-300	1	0 ... 10 V	286-870/000-300	1
	0 ... 20 mA	286-861/000-300	1	0 ... 20 mA	286-871/000-300	1
	4 ... 20 mA	286-862/000-300	1	4 ... 20 mA	286-872/000-300	1

Technical Data

Accessories see page 233

Accessories see page 233

Temperature range	0 °C ... 300 °C	0 °C ... 300 °C
Operating voltage	24 V DC (± 10 %)	24 V DC (± 10 %)
Nominal current	I _N 30 mA	I _N 30 mA
Load impedance	≥ 2 kΩ (Out = V) ≤ 500 Ω (Out = mA)	≥ 2 kΩ (Out = V) ≤ 500 Ω (Out = mA)
Error output (closed-current principle)	V _B / 20 mA	V _B / 20 mA
Transmission error (full scale)	≤ 0.2 %	≤ 0.2 %
Temperature coefficient	≤ 0.02 %/K	0.02 %/K
Ambient operating temperature	0 °C ... +55 °C	0 °C ... +55 °C
Electromagnetic compatibility test acc. to IEC 801-2/4/5	B acc. to EN 50082 T2 (E3.94)	B acc. to EN 50082 T2 (E3.94)

Accessories

Accessories	Item No.	Pack. Unit	Item No.	Pack. Unit
Terminal block for pluggable modules, with 2-conductor terminal blocks, orange separator ①	22 mm / 0.866 in 280-638	1	22 mm / 0.866 in 280-638	1
with 4-conductor terminal blocks, orange separator ②	22 mm / 0.866 in 280-628	1	22 mm / 0.866 in 280-628	1
with 4-conductor terminal blocks, marker plate ③	25 mm / 0.984 in 280-764	1	25 mm / 0.984 in 280-764	1
wire range 0.08 mm ² ... 2.5 mm ² / AWG 28 ... 14; stripped length 8 ... 9 mm / 0.33 in				

3 Pluggable Modules - Temperature Transducers

228

	Input: Pt1000 type RTD element 2-wire, with error output for broken wire and short circuit of sensor 0 °C ... +100 °C Module width 20 mm / 0.787 in	
--	--	--

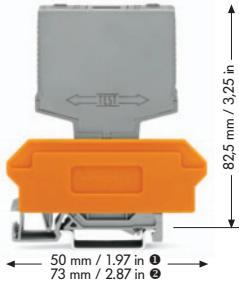

Linear temperature curve
 Other temperature ranges contact factory.
 LED indication of broken wire or short circuit

- WSB marker card
- Marking 1 ... 10; Item No.: 209-702
 - Marking 1, 2, 0V, +UB, OUT, ERR., 0V;
 Item No.: 249-623

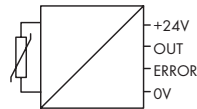

5 cards, each containing 10 strips with 10 markers

Description	Output	Item No.	Pack. Unit
Temperature transducer	0 ... 10 V	286-873	1
	0 ... 20 mA	286-874	1
	4 ... 20 mA	286-875	1

Technical Data		Accessories see page 233	
Temperature range	0 °C ... 100 °C		
Operating voltage	24 V DC (± 10 %)		
Nominal current	I _N 30 mA		
Load impedance	≥ 2 kΩ (Out = V) ≤ 500 Ω (Out = mA)		
Error output (closed-current principle)	V _B / 20 mA		
Transmission error (full scale)	≤ 0.3 %		
Temperature coefficient	0.02 %/K		
Ambient operating temperature	0 °C ... +55 °C		
Electromagnetic compatibility test acc. to IEC 801-2/4/5	B acc. to EN 50082 T2 (E3.94)		

Accessories	Item No.	Pack. Unit
Terminal block for pluggable modules, with 2-conductor terminal blocks, orange separator ❶ with 4-conductor terminal blocks, marker plate ❷ wire range 0.08 mm ² ... 2.5 mm ² / AWG 28 ... 14; stripped length 8 ... 9 mm / 0.33 in	22 mm / 0.866 in 280-628	1

3 Pluggable Modules - Analog Signal Conditioning

230

	<p>Separate supply voltage for input/output Isolation voltage input/output 4 kV Input signal 0 V ... 10 V</p> <p>Module width 20 mm/ 0.787 in</p>	<p>Electrically isolated supply of input/output via DC/DC converter Isolation voltage input/output/supply voltage 4 kV Input signal 0 V ... 10 V</p> <p>Module width 20 mm/ 0.787 in</p>
--	---	--

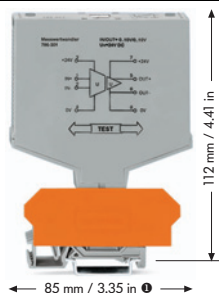

WSB marker card

- Marking V; Item No.: 209-784
- Marking 1 ... 10; Item No.: 209-702
- Marking +/-; Item No.: 209-652

5 cards, each containing 10 strips with 10 markers

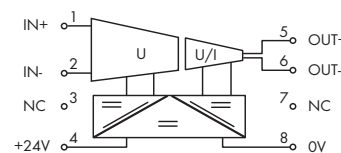
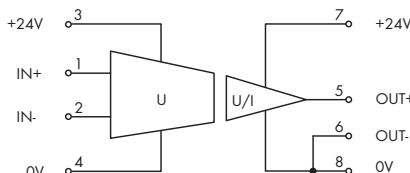

Description	Output signal	Item No.	Pack. Unit	Output signal	Item No.	Pack. Unit
Analog signal conditioning modules, for signal transformation, amplification and transmission with electrical isolation of input and output of standard signals.	0 - 10 V	786-301	1	0 - 10 V	786-321	1
	0 - 20 mA	786-302	1	0 - 20 mA	786-322	1
	4 - 20 mA	786-303	1	4 - 20 mA	786-323	1

Technical Data

Accessories see page 233

Accessories see page 233

Input signal	0 V ... 10 V	0 V ... 10 V
Max. input voltage	13 V	13 V
Input resistance	100 kΩ	100 kΩ
Load impedance	≥ 2 kΩ (Out = V); ≤ 750 Ω (Out = mA)	≥ 2 kΩ (Out = V); ≤ 750 Ω (Out = mA)
Line break detection	Measuring output (LED green = off)	Measuring output (LED green = off)
Transmission error (full scale)	≤ 0.15 %	≤ 0.15 %
Error of transmission typ.	≤ 0.1 %	≤ 0.1 %
Temperature coefficient (full scale)	≤ 0.02 %/K	≤ 0.02 %/K
Critical frequency (sinus)	1 kHz	1 kHz
Isolation voltage input / output	4 kV, 50 Hz, 1 min	4 kV, 50 Hz, 1 min
Supply voltage RR ≤ 6 % input/output	20 V ... 30 V DC	20 V ... 28 V DC
Power consumption input	8 mA ... 20 mA	60 mA
Power consumption output	15 mA ... 40 mA	60 mA
Nominal voltage acc. to VDE 0110 Part 1/4.97, IEC 60664-1	250 V / 4 kV / 3	250 V / 4 kV / 3
Ambient operating temperature	0 °C ... +55 °C	0 °C ... +55 °C
Storage temperature	-40 °C ... +80 °C	-40 °C ... +80 °C
Approvals	EMC testing IEC 60801-2/4/5, Grade B met acc. to EN 50 082 Part 2 (suppl. 3.94)	EMC testing IEC 60801-2/4/5, Grade B met acc. to EN 50 082 Part 2 (suppl. 3.94)

Accessories

Accessories	Item No.	Pack. Unit	Item No.	Pack. Unit
Terminal block for pluggable modules, with 2-conductor terminal blocks, orange separator ①	22 mm / 0.866 in 280-638	1	22 mm / 0.866 in 280-638	1
with 4-conductor terminal blocks, orange separator ②	22 mm / 0.866 in 280-628	1	22 mm / 0.866 in 280-628	1
with 4-conductor terminal blocks, marker plate ③	25 mm / 0.984 in 280-764	1	25 mm / 0.984 in 280-764	1
wire range 0.08 mm ² ... 2.5 mm ² / AWG 28 ... 14; stripped length 8 ... 9 mm / 0.33 in				

	<p>Separate supply voltage for input/output Isolation voltage input/output 4 kV Input signal 0 mA ... 20 mA</p> <p>Module width 20 mm/ 0.787 in</p>	<p>Separate supply voltage for input/output Isolation voltage input/output 4 kV Input signal 4 mA ... 20 mA</p> <p>Module width 20 mm/ 0.787 in</p>
--	---	---

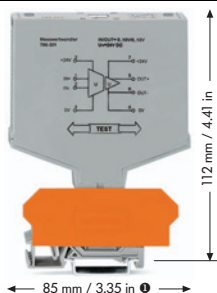

WSB marker card

- Marking V; Item No.: 209-784
- Marking 1 ... 10; Item No.: 209-702
- Marking +/-; Item No.: 209-652

5 cards, each containing 10 strips with 10 markers

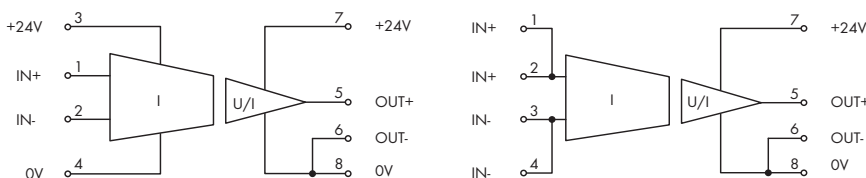

Description	Output signal	Item No.	Pack. Unit	Output signal	Item No.	Pack. Unit
Analog signal conditioning modules, for signal transformation, amplification and transmission with electrical isolation of input and output of standard signals.	0 - 10 V	786-304	1	0 - 10 V	786-307	1
	0 - 20 mA	786-305	1	0 - 20 mA	786-308	1
	4 - 20 mA	786-306	1	4 - 20 mA	786-309	1

Technical Data

Accessories see page 233

Accessories see page 233

Input signal	0 mA ... 20 mA	4 mA ... 20 mA
Max. input current	22 mA	22 mA
Input resistance	≤ 50 Ω	≤ 400 Ω
Max. voltage drop at input		≤ 8 V
Load impedance	≥ 2 kΩ (Out = V); ≤ 750 Ω (Out = mA)	≥ 2 kΩ (Out = V); ≤ 750 Ω (Out = mA)
Line break detection	Measuring output (LED green = off)	Measuring input (LED green = off) and Measuring output (LED green = off) (786-309)
Transmission error (full scale)	≤ 0.15 %	≤ 0.15 %
Error of transmission typ.	≤ 0.1 %	≤ 0.1 %
Temperature coefficient (full scale)	≤ 0.02 %/K	≤ 0.02 %/K
Critical frequency (sinus)	1 kHz	1 kHz
Isolation voltage input / output	4 kV, 50 Hz, 1 min	4 kV, 50 Hz, 1 min
Supply voltage RR ≤ 6 % input/output	20 V ... 30 V DC	20 V ... 30 V DC
Power consumption input	7 mA ... 18 mA	7 mA ... 18 mA
Power consumption output	9 ... 16 mA; 13 ... 35 mA; 22 ... 40 mA	25 mA; 50 mA; 50 mA
Nominal voltage acc. to VDE 0110 Part 1/4.97, IEC 60664-1	250 V / 4 kV / 3	250 V / 4 kV / 3
Ambient operating temperature	0 °C ... + 55 °C	0 °C ... + 55 °C
Storage temperature	-40 °C ... +80 °C	-40 °C ... +80 °C

Accessories

Accessories	Item No.	Pack. Unit	Item No.	Pack. Unit
Terminal block for pluggable modules, with 2-conductor terminal blocks, orange separator ①	22 mm / 0.866 in 280-638	1	22 mm / 0.866 in 280-638	1
with 4-conductor terminal blocks, orange separator ②	22 mm / 0.866 in 280-628	1	22 mm / 0.866 in 280-628	1
with 4-conductor terminal blocks, marker plate ③	25 mm / 0.984 in 280-764	1	25 mm / 0.984 in 280-764	1
wire range 0.08 mm ² ... 2.5 mm ² / AWG 28 ... 14; stripped length 8 ... 9 mm / 0.33 in				

3 Pluggable Modules - Analog Signal Conditioning

232

	<p>Electrically isolated supply of input/output via DC/DC converter Isolation voltage input/output/supply voltage 4 kV Input signal 0 mA ... 20 mA Module width 20 mm/ 0.787 in</p>	<p>Electrically isolated supply of input/output via DC/DC converter Isolation voltage input/output/supply voltage 4 kV Input signal 0 mA ... 20 mA Module width 20 mm/ 0.787 in</p>
--	--	--

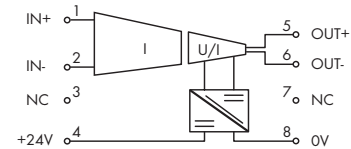
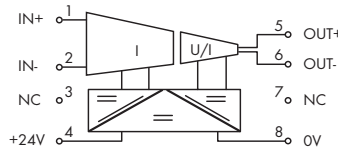
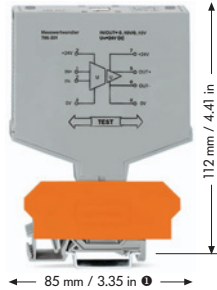

WSB marker card
 • Marking V; Item No.: 209-784
 • Marking 1 ... 10; Item No.: 209-702
 • Marking +/-; Item No.: 209-652
 5 cards, each containing 10 strips with 10 markers

Description	Output signal	Item No.	Pack. Unit	Output signal	Item No.	Pack. Unit
Analog signal conditioning modules, for signal transformation, amplification and transmission with electrical isolation of input and output of standard signals.	0 - 10 V	786-324	1	0 - 10 V	786-337	1
	0 - 20 mA	786-325	1	0 - 20 mA	786-338	1
	4 - 20 mA	786-326	1	4 - 20 mA	786-339	1

Technical Data	Accessories see page 233		Accessories see page 233	
Input signal	0 mA ... 20 mA		4 mA ... 20 mA	
Max. input current	22 mA		22 mA	
Input resistance	≤ 50 Ω		≤ 400 Ω	
Max. voltage drop at input			≤ 8 V	
Load impedance	≥ 2 kΩ (Out = V); ≤ 750 Ω (Out = mA)		≥ 2 kΩ (Out = V); ≤ 750 Ω (Out = mA)	
Line break detection	Measuring input (LED green = off)		Measuring input (LED green = off) and Measuring output (LED green = off) (786-339)	
Transmission error (full scale)	≤ 0.15 %		≤ 0.15 %	
Error of transmission typ.	≤ 0.1 %		≤ 0.1 %	
Temperature coefficient (full scale)	≤ 0.02 %/K		≤ 0.02 %/K	
Critical frequency (sinus)	1 kHz		1 kHz	
Isolation voltage input / output	4 kV, 50 Hz, 1 min		4 kV, 50 Hz, 1 min	
Supply voltage RR ≤ 6 % input/output	20 V ... 28 V DC		20 V ... 28 V DC	
Power consumption input	70 mA; 90 mA; 95 mA		35 mA; 60 mA; 60 mA	
Power consumption output	70 mA; 90 mA; 95 mA		35 mA; 60 mA; 60 mA	
Nominal voltage acc. to VDE 0110 Part 1/4.97, IEC 60664-1	250 V / 4 kV / 3		250 V / 4 kV / 3	
Ambient operating temperature	0 °C ... + 55 °C		0 °C ... + 55 °C	
Storage temperature	-40 °C ... +80 °C		-40 °C ... +80 °C	

Accessories	Item No.	Pack. Unit	Item No.	Pack. Unit
Terminal block for pluggable modules, with 2-conductor terminal blocks, orange separator ①	22 mm / 0.866 in 280-638	1	22 mm / 0.866 in 280-638	1
with 4-conductor terminal blocks, orange separator ②	22 mm / 0.866 in 280-628	1	22 mm / 0.866 in 280-628	1
with 4-conductor terminal blocks, marker plate ③	25 mm / 0.984 in 280-764	1	25 mm / 0.984 in 280-764	1
wire range 0.08 mm ² ... 2.5 mm ² / AWG 28 ... 14; stripped length 8 ... 9 mm / 0.33 in				

WSB Marker Cards

Miniature quick marking card

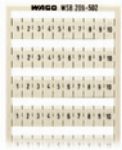

Description	Item No.	Pack. Unit
Marking: K	209-782	5 cards
1 ... 10 (10 x)	209-702	5 cards
A1, A2, 13, 14	209-952	5 cards
A1, A2, 11, 12	209-953	5 cards
11, 12, 14, A1, A2, A2, 11, 12, 14	209-994	5 cards
12, A1, A2, 24, 11, 14, 21, 22	209-995	5 cards
A1, A1, A2, A2, 11, 12, 13, 14, 23, 24	209-693	5 cards
12, A1, A2, 23, 24, 11, 13, 14, 21, 22	209-691	5 cards
12, A1, A2, 23, 24, 11, 13, 14, 33, 34	209-690	5 cards
14, A1, A2, 33, 34, 13, 23, 24, 43, 44	209-692	5 cards
A1, A2, 32, 31, 34, 42, 41, 12, 11, 14, 22, 21, 24, 44	249-656	5 cards
L+, 1, L-, L-, 11, 12, 13, 14	209-954	5 cards
A1, A2, A3, 11, 12, 14	249-607	5 cards
A1, A1, A2, A2, 12, 11, 11, 14	209-996	5 cards
A1, A1, St, A2, A2, 12, 11, 11, 14	209-601	5 cards
U1, U2, U3, U4, OV, 12, 11, 11, 14, 14	209-951	5 cards
U	209-789	5 cards
A1, A2, A2, 1, 3, 2	209-685	5 cards
A1, A2, A2, 1, 2, 2	209-686	5 cards
A1+, A1+, A2-, A2-, 1, RL1, RL2, 2	209-955	5 cards
A1+, A1+, A2-, A2-, 1+, 1+, A, 2-	249-651	5 cards
+/-	209-552	5 cards
1, 2, 3, OV, +UB, OUT, ERR., OV	249-622	5 cards
1, 2, OV, +UB, OUT, ERR., OV	249-623	5 cards
Lin, Lin, Lout, Lout, 24V, UA, UA, OV	209-957	5 cards
Lin, Lin, Lout, 11, 14, 14, Lin, Lin, Lout	249-654	5 cards
lin, lin, lout, lout, 24V, 11, 12, 14, OV	209-997	5 cards
S	209-682	5 cards
V	209-784	5 cards
F1 ... F10	209-787	5 cards
D	209-783	5 cards
+, -, 1, 2, 3, 13, 14, 4, 5, 6	249-608	5 cards
L, N, Quitt, Störung, Test, N, 14, 24	249-606	5 cards
A1, A2, Quitt, Störung, 12, 11, 11, 14	249-653	5 cards

5 cards, each containing 10 strips with 10 markers

Colored marker cards



Description	Item No.	Pack. Unit	
Marker cards and tags WSB 4 mm/0.157 in (plain)	white	209-701	5 cards
Marking software and printer/plotter see Section 8	yellow	209-701/000-002	5 cards
	red	209-701/000-005	5 cards
	blue	209-701/000-006	5 cards
	gray	209-701/000-007	5 cards
	orange	209-701/000-012	5 cards
	light green	209-701/000-017	5 cards
	green	209-701/000-023	5 cards
	violet	209-701/000-024	5 cards

5 cards, each containing 10 strips with 10 markers

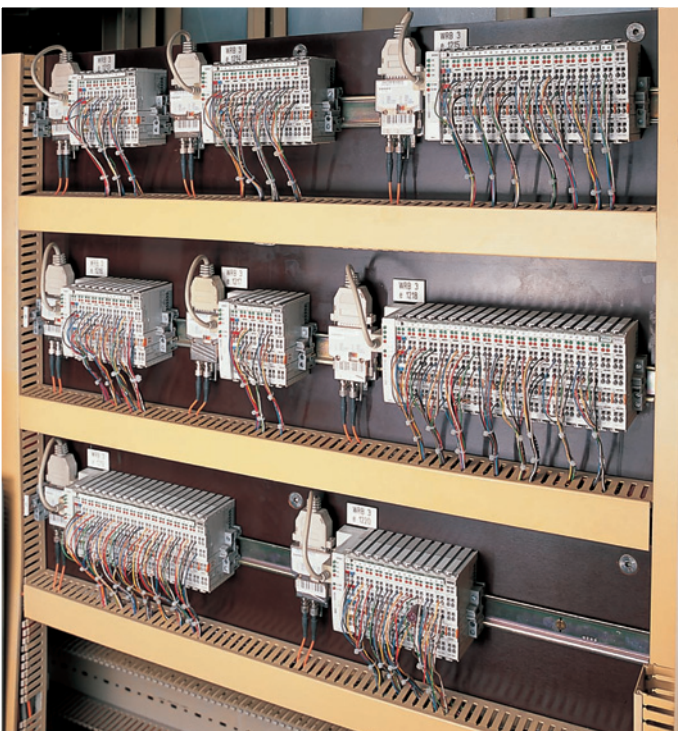

**WAGO Application: Steag, Power Plant in Voerde,
Germany**

WAGO Products:
WAGO-I/O-SYSTEM with MODBUS Couplers

4

4



787 Series
EPSITRON - PRO - Power Supplies 236 - 239



787 Series
EPSITRON - CLASSIC - Power Supplies 240 - 245



787 Series
EPSITRON - ECO - Power Supplies 246 - 247



787 Series
EPSITRON - Electronic Circuit Breakers 248 - 249



787 Series
EPSITRON - UPS Charger and Controller 250
EPSITRON - Lead Gel Battery Modules 251 - 252



288, 787 Series
EPSITRON - Capacitive Buffer Modules 253
EPSITRON - Back-up Capacitor Module 254



787 Series
EPSITRON - Redundancy Module 255
EPSITRON - Communication Cable 256



288, 289 Series
 Rail-Mounted Modules - Constant Voltage Sources 258 - 259
 Rail-Mounted Modules - Power Supplies 260 - 263

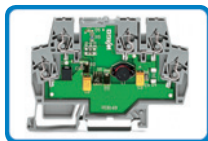

859, 289, 288 Series
 Rail-Mounted Terminal Blocks with DC/DC Converters 264 - 265
 Rail-Mounted Modules - DC/DC Converter 266

Output voltage 24 V DC; 5 A,
open circuit and short-circuit protected,
adjustable output voltage,
LED status indication,
PowerBoost

Output voltage 24 V DC; 10 A,
open circuit and short-circuit protected,
adjustable output voltage,
LED status indication,
PowerBoost

- Primary switch mode power supply with PowerBoost and TopBoost
- Stand-by input for switching off the output and minimizing power consumption
- Parallel operation, series connection possible
- Prepared for class I equipment
- Natural convection cooling when horizontally mounted
- Enclosed for use in switchgear cabinets

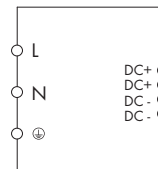
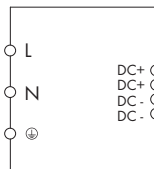

Description	Vo nom	Item No.	Pack. unit	Vo nom	Item No.	Pack. unit
Primary switch mode power supplies, for DIN 35 rail	24 V DC, SELV	787-822	1	24 V DC, SELV	787-832	1
Technical Data						
Nominal input voltage Vi nom	100 V ... 240 V AC			100 V ... 240 V AC		
Input voltage range	85 V ... 264 V AC (120 V ... 373 V DC)			85 V ... 264 V AC (120 V ... 373 V DC)		
Frequency	44 Hz ... 66 Hz			44 Hz ... 66 Hz		
Input current Ii	0.97 A at 230 V AC and 5 A DC			1.2 A at 230 V AC and 10 A DC		
Inrush current	< 15 A			≤ Ie (active inrush current limitation)		
Mains failure hold-up time	35 ms typ. at 230 V AC			24 ms typ. at 230 V AC		
Internal/external fuse	4 AT			6.3 AT		
Nominal output voltage Vo nom	24 V DC, SELV			24 V DC, SELV		
Output voltage range	22 V... 29.5 V DC adjustable			22 V... 29.5 V DC adjustable		
Output current Io	5 A at 24 V DC			10 A at 24 V DC		
PowerBoost	10 A DC (for 4 sec.); 7.5 A DC (for another 2 sec.)			20 A DC (for 4 sec.); 15 A DC (for another 2 sec.)		
TopBoost	23 A DC (for 25 ms)			60 A DC (for 25 ms)		
Residual ripple	< 70 mVpp			< 70 mVpp		
Derating	-2.5 % / K (> 55 °C)			-2.5 % / K (> 55 °C)		
Adjustment accuracy	1 %			1 %		
Current limitation	1.1 x Io typ.			1.1 x Io typ.		
Efficiency	87.8 % typ.			91.8 % typ.		
Test voltage pri.-gr./pri.-sec./sec.-gr.	- / 4.2 kV / -			- / 4.2 kV / -		
Degree of protection	IP20			IP20		
Operational indication	LED green (Vo), LED red (error)			LED green (Vo), LED red (error)		
Power loss Pv	0.5 W (stand-by) / 5.0 W (no load) / 14.6 W (rated load)			0.8 W (stand-by) / 3.5 W (no load) / 19.7 W (rated load)		
Signaling	Relay contact DC O.K. (changeover contact)			Relay contact DC O.K. (changeover contact)		
Type of mounting	DIN-rail mounting (EN 60715) in 2 positions			DIN-rail mounting (EN 60715) in 2 positions		
Ambient operating temperature	-10 °C ... +70 °C			-10 °C ... +70 °C		
Storage temperature	-25 °C ... +85 °C			-25 °C ... +85 °C		
Dimensions (mm) W x H x L	57 x 163 x 163			57 x 163 x 179		
Wire connection	Height from upper-edge of DIN 35 rail Input/Output: WAGO 231 Series / WAGO 231 Series Signalising: WAGO 733 Series			Height from upper-edge of DIN 35 rail Input/Output: WAGO 231 Series / WAGO 231 Series Signalising: WAGO 733 Series		
Cross sections	Input: 0.08 mm ² ... 2.5 mm ² / AWG 28 ... 12 Output: 0.08 mm ² ... 2.5 mm ² / AWG 28 ... 12 Signalising: 0.08 mm ² ... 0.5 mm ² / AWG 28 ... 20			Input: 0.08 mm ² ... 2.5 mm ² / AWG 28 ... 12 Output: 0.08 mm ² ... 2.5 mm ² / AWG 28 ... 12 Signalising: 0.08 mm ² ... 0.5 mm ² / AWG 28 ... 20		
Stripped lengths	Input: 8 ... 9 mm / 0.33 in Output: 8 ... 9 mm / 0.33 in Signalising: 5 ... 6 mm / 0.22 in			Input: 8 ... 9 mm / 0.33 in Output: 8 ... 9 mm / 0.33 in Signalising: 5 ... 6 mm / 0.22 in		
Weight	1100 g			1300 g		
Approvals	EN 60950, EN 61204-3, UL 60950*, UL 508*, EN 61000-6-2, EN 61000-6-3 (* pending)			EN 60950, EN 61204-3, UL 60950*, UL 508*, EN 61000-6-2, EN 61000-6-3 (* pending)		

	<p>Output voltage 24 V DC; 10 A open circuit and short-circuit protected, adjustable output voltage, LED status indication; PowerBoost</p>	<p>Output voltage 24 V DC; 10 A open circuit and short-circuit protected, adjustable output voltage, LED status indication; PowerBoost; LineMonitor</p>
--	---	--

- Primary switch mode power supply with PowerBoost and TopBoost
- Line monitor for parameter setting and monitoring
- prepared for class I equipment
- natural convection cooling when horizontally mounted
- encapsulated, for use in switchgear cabinets

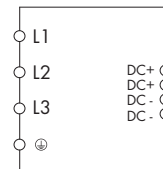
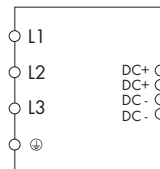

Description	Vo nom	Item No.	Pack. unit	Vo nom	Item No.	Pack. unit
Primary switch mode power supplies, for DIN 35 rail	24 V DC, SELV	787-840	1	24 V DC, SELV	787-850	1

Technical Data

Nominal input voltage Vi nom	3x (2x) 400 V ... 500 V AC	3x (2x) 400 V ... 500 V AC
Input voltage range	340 V ... 550 V AC / 480 V ... 780 V DC	340 V ... 550 V AC / 480 V ... 780 V DC
Frequency	50 Hz ... 60 Hz	50 Hz ... 60 Hz
Input current Ii	3 x 0.6 A at 340 V AC and 10 A DC	3 x 0.6 A at 340 V AC and 10 A DC
Inrush current	< 30 A	< 30 A
Mains failure hold-up time	22 ms typ. at 3 x 400 V AC	22 ms typ. at 3 x 400 V AC
Internal/external fuse	3 x 1.6 AT / -	3 x 1.6 AT / -
Nominal output voltage Vo nom	24 V DC, SELV	24 V DC, SELV
Output voltage range	22.8 V ... 28.8 V DC adjustable	22.8 V ... 28.8 V DC adjustable
Output current Io	10 A at 24 V DC	10 A at 24 V DC
PowerBoost	20 A DC (for 4 s); 15 A DC (for 8 s)	20 A DC (for 4 s); 15 A DC (for 8 s)
TopBoost	70 A DC (for 50 ms)	70 A DC (for 50 ms)
Residual ripple	< 70 mVpp	< 70 mVpp
Derating	-3 % / K (> 50 °C)	-3 % / K (> 50 °C)
Adjustment accuracy	1 %	1 %
Current limitation	1.1 x Io typ.	1.1 x Io typ.
Efficiency	91.7 % typ.	91.7 % typ.
Test voltage pri.-gr./pri.-sec./sec.-gr.	- / 4.2 kV / -	- / 4.2 kV / -
Degree of protection	IP20	IP20
Operational indication	LED green (Vo), LED red (error)	LED green (Vo), LED yellow (warning), LED red (error)
Signaling		LED, LCD, 4 x signal output 24 V DC, 25 mA via LCD and RS-232 serial interface
LineMonitor, parameter setting		
Type of mounting	DIN-rail mounting (EN 60715) in 2 positions	DIN-rail mounting (EN 60715) in 2 positions
Ambient operating temperature	-10 °C ... +70 °C	-10 °C ... +70 °C
Storage temperature	-25 °C ... +85 °C	-25 °C ... +85 °C
Dimensions (mm) W x H x L	57 x 163 x 179	57 x 163 x 179
Wire connection	Height from upper-edge of DIN 35 rail Input/Output: WAGO 231 Series / WAGO 231 Series	Height from upper-edge of DIN 35 rail Input/Output: WAGO 231 Series / WAGO 231 Series Signalising: WAGO 733 Series
Cross sections	Input: 0.08 mm ² ... 2.5 mm ² / AWG 28 ... 12 Output: 0.08 mm ² ... 2.5 mm ² / AWG 28 ... 12	Input: 0.08 mm ² ... 2.5 mm ² / AWG 28 ... 12 Output: 0.08 mm ² ... 2.5 mm ² / AWG 28 ... 12 Signalising: 0.08 mm ² ... 0.5 mm ² / AWG 28 ... 20
Stripped lengths	Input: 8 ... 9 mm / 0.33 in Output: 8 ... 9 mm / 0.33 in	Input: 8 ... 9 mm / 0.33 in Output: 8 ... 9 mm / 0.33 in Signalising: 5 ... 6 mm / 0.22 in
Weight	1000 g	1000 g
Approvals	EN 60950, EN 61204-3, UL 60950, UL 508, EN 61000-6-2, EN 61000-6-3	EN 60950, EN 61204-3, UL 60950, UL 508, EN 61000-6-2, EN 61000-6-3

Output voltage 24 V DC; 10 A
open circuit and short-circuit protected,
adjustable output voltage,
LED status indication;
PowerBoost

Output voltage 24 V DC; 10 A
open circuit and short-circuit protected,
adjustable output voltage,
LED status indication;
PowerBoost;
LineMonitor

- Primary switch mode power supply with PowerBoost and TopBoost
- Line monitor for parameter setting and monitoring
- prepared for class I equipment
- natural convection cooling when horizontally mounted
- encapsulated, for use in switchgear cabinets

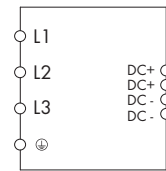
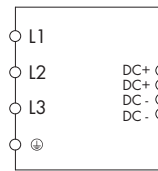

Description	Vo nom	Item No.	Pack. unit	Vo nom	Item No.	Pack. unit
Primary switch mode power supplies, for DIN 35 rail	24 V DC, SELV	787-842	1	24 V DC, SELV	787-852	1
Technical Data						
Nominal input voltage Vi nom	3x (2x) 400 V ... 500 V AC			3x (2x) 400 V ... 500 V AC		
Input voltage range	340 V ... 550 V AC / 480 V ... 780 V DC			340 V ... 550 V AC / 480 V ... 780 V DC		
Frequency	50 Hz ... 60 Hz			50 Hz ... 60 Hz		
Input current Ii	3 x 1.0 A at 340 V AC and 20 A DC			3 x 1.0 A at 340 V AC and 20 A DC		
Inrush current	< 30 A			< 30 A		
Mains failure hold-up time	13 ms typ. at 3 x 400 V AC			13 ms typ. at 3 x 400 V AC		
Internal/external fuse	3 x 2.5 AT / -			3 x 2.5 AT / -		
Nominal output voltage Vo nom	24 V DC, SELV			24 V DC, SELV		
Output voltage range	22.8 V ... 28.8 V DC adjustable			22.8 V ... 28.8 V DC adjustable		
Output current Io	20 A at 24 V DC			20 A at 24 V DC		
PowerBoost	40 A DC (for 4 s); 30 A DC (for 8 s)			40 A DC (for 4 s); 30 A DC (for 8 s)		
TopBoost	80 A DC (for 50 ms)			80 A DC (for 50 ms)		
Residual ripple	< 70 mVpp			< 70 mVpp		
Derating	-3 % / K (> 50 °C)			-3 % / K (> 50 °C)		
Adjustment accuracy	1 %			1 %		
Current limitation	1.1 x Io typ.			1.1 x Io typ.		
Efficiency	92.9 % typ.			92.9 % typ.		
Test voltage pri.-gr./pri.-sec./sec.-gr.	- / 4.2 kV / -			- / 4.2 kV / -		
Degree of protection	IP20			IP20		
Operational indication	LED green (Vo), LED red (error)			LED green (Vo), LED yellow (warning), LED red (error)		
Signaling				LED, LCD, 4 x signal output 24 V DC, 25 mA		
LineMonitor, parameter setting				via LCD and RS-232 serial interface		
Type of mounting	DIN-rail mounting (EN 60715) in 2 positions			DIN-rail mounting (EN 60715) in 2 positions		
Ambient operating temperature	-10 °C ... +70 °C			-10 °C ... +70 °C		
Storage temperature	-25 °C ... +85 °C			-25 °C ... +85 °C		
Dimensions (mm) W x H x L	77 x 171 x 179			77 x 171 x 179		
Wire connection	Height from upper-edge of DIN 35 rail Input/Output: WAGO 231 Series / WAGO 831 Series			Height from upper-edge of DIN 35 rail Input/Output: WAGO 231 Series / WAGO 831 Series		
Cross sections	Input: 0.08 mm ² ... 2.5 mm ² / AWG 28 ... 12 Output: 0.5 mm ² ... 10 mm ² / AWG 20 ... 8			Input: 0.08 mm ² ... 2.5 mm ² / AWG 28 ... 12 Output: 0.5 mm ² ... 10 mm ² / AWG 20 ... 8		
Stripped lengths	Input: 8 ... 9 mm / 0.33 in Output: 13 ... 15 mm / 0.55 in			Input: 8 ... 9 mm / 0.33 in Output: 13 ... 15 mm / 0.55 in		
Weight	1300 g			1300 g		
Approvals	EN 60950, EN 61204-3, UL 60950, UL 508, EN 61000-6-2, EN 61000-6-3			EN 60950, EN 61204-3, UL 60950, UL 508, EN 61000-6-2, EN 61000-6-3		

	<p>Output voltage 24 V DC; 10 A open circuit and short-circuit protected, adjustable output voltage, LED status indication; PowerBoost</p>	<p>Output voltage 24 V DC; 10 A open circuit and short-circuit protected, adjustable output voltage, LED status indication; PowerBoost; LineMonitor</p>
--	---	--

- Primary switch mode power supply with PowerBoost and TopBoost
- Line monitor for parameter setting and monitoring
- prepared for class I equipment
- natural convection cooling when horizontally mounted
- encapsulated, for use in switchgear cabinets

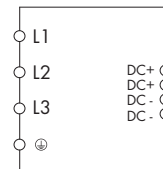
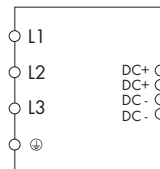

Description	Vo nom	Item No.	Pack. unit	Vo nom	Item No.	Pack. unit
Primary switch mode power supplies, for DIN 35 rail	24 V DC, SELV	787-844	1	24 V DC, SELV	787-854	1

Technical Data

Nominal input voltage Vi nom	3x (2x) 400 V ... 500 V AC	3x (2x) 400 V ... 500 V AC
Input voltage range	340 V ... 550 V AC / 480 V ... 780 V DC	340 V ... 550 V AC / 480 V ... 780 V DC
Frequency	50 Hz ... 60 Hz	50 Hz ... 60 Hz
Input current Ii	3 x 2.0 A at 340 V AC and 40 A DC	2.0 A at 340 V AC
Inrush current	< 30 A	< 30 A
Mains failure hold-up time	15 ms typ. at 3 x 400 V AC	15 ms typ. at 3 x 400 V AC
Internal/external fuse	3 x 3.2 AT / -	3 x 3.2 AT / -
Nominal output voltage Vo nom	24 V DC, SELV	24 V DC, SELV
Output voltage range	22.8 V ... 28.8 V DC adjustable	22.8 V ... 28.8 V DC adjustable
Output current Io	40 A at 24 V DC	40 A at 24 V DC
PowerBoost	60 A DC (for 4 s); 50 A DC (for 8 s)	60 A DC (for 4 s); 50 A DC (for 8 s)
TopBoost	100 A DC (for 50 ms)	100 A DC (for 50 ms)
Residual ripple	< 70 mVpp	< 70 mVpp
Derating	-5 % / K (> 45 °C)	-5 % / K (> 45 °C)
Adjustment accuracy	1 %	1 %
Current limitation	1.1 x Io typ.	1.1 x Io typ.
Efficiency	93.6 % typ.	93.6 % typ.
Test voltage pri.-gr./pri.-sec./sec.-gr.	- / 4.2 kV / -	- / 4.2 kV / -
Degree of protection	IP20	IP20
Operational indication	LED green (Vo), LED red (error)	LED green (Vo), LED yellow (warning), LED red (error)
Signaling		LED, LCD, 4 x signal output 24 V DC, 25 mA via LCD and RS-232 serial interface
LineMonitor, parameter setting		
Type of mounting	DIN-rail mounting (EN 60715) in 2 positions	DIN-rail mounting (EN 60715) in 2 positions
Ambient operating temperature	-10 °C ... +55 °C	-10 °C ... +55 °C
Storage temperature	-25 °C ... +85 °C	-25 °C ... +85 °C
Dimensions (mm) W x H x L	128 x 171 x 205	128 x 171 x 205
Wire connection	Height from upper-edge of DIN 35 rail Input/Output: WAGO 231 Series / WAGO 831 Series	Height from upper-edge of DIN 35 rail Input/Output: WAGO 231 Series / WAGO 831 Series Signalising: WAGO 733 Series
Cross sections	Input: 0.08 mm² ... 2.5 mm² / AWG 28 ... 12 Output: 0.5 mm² ... 10 mm² / AWG 20 ... 8	Input: 0.08 mm² ... 2.5 mm² / AWG 28 ... 12 Output: 0.5 mm² ... 10 mm² / AWG 20 ... 8 Signalising: 0.08 mm² ... 0.5 mm² / AWG 28 ... 20
Stripped lengths	Input: 8 ... 9 mm / 0.33 in Output: 13 ... 15 mm / 0.55 in	Input: 8 ... 9 mm / 0.33 in Output: 13 ... 15 mm / 0.55 in Signalising: 5 ... 6 mm / 0.22 in
Weight	2500 g	2500 g
Approvals	EN 60950, EN 61204-3, UL 60950, UL 508, EN 61000-6-2, EN 61000-6-3	EN 60950, EN 61204-3, UL 60950, UL 508, EN 61000-6-2, EN 61000-6-3

Output voltage 24 V DC; 2.5 A open circuit and short-circuit protected, adjustable output voltage, LED status indication, parallel connection possible, thermal overload protection

Output voltage 24 V DC; 5 A open circuit and short-circuit protected, adjustable output voltage, LED status indication, parallel connection possible, thermal overload protection

- prepared for class I equipment
- natural convection cooling when horizontally mounted
- encapsulated, for use in switchgear cabinets

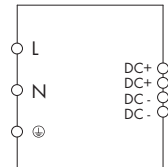
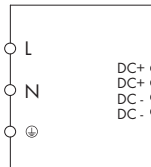

Description	Vo nom	Item No.	Pack. unit	Vo nom	Item No.	Pack. unit
Primary switch mode power supplies, for DIN 35 rail	24 V DC, SELV	787-612	1	24 V DC, SELV	787-622	1
Technical Data						
Nominal input voltage Vi nom	110 V ... 230 V AC			110 V ... 230 V AC		
Input voltage range	90 V ... 264 V AC; 130 V ... 300 V DC (use of DC requires external protection)			90 V ... 264 V AC; 130 V ... 300 V DC (use of DC requires external protection)		
Frequency	50 Hz ... 60 Hz			50 Hz ... 60 Hz		
Input current Ii	0.6 A typ. at 230 V AC			1.2 A typ. at 230 V AC		
Inrush current	< 10 A			< 50 A		
Discharge current	940 µA typ.			550 µA typ.		
Mains failure hold-up time	> 20 ms at 230 V AC			> 20 ms at 230 V AC		
Nominal output voltage Vo nom	24 V DC, SELV			24 V DC, SELV		
Output voltage range	22 V ... 28.8 V DC adjustable			22 V ... 28.8 V DC adjustable		
Output current Io	2.5 A at 24 V DC			5 A at 24 V DC		
Residual ripple	< 100 mVpp to 20 MHz			< 100 mVpp to 20 MHz		
Derating	-3 % / K (>55 °C)			-3 % / K (>55 °C)		
Adjustment accuracy	1.5 %			1.5 %		
Current limitation	from approx. 1.1 x Io			from approx. 1.1 x Io		
Efficiency	88 % typ.			89 % typ.		
Test voltage pri.-gr./pri.-sec./sec.-gr.	4.2 kV			4.2 kV		
Degree of protection	IP20			IP20		
Operational indication	LED green (24 V o.k.)			LED green (24 V o.k.)		
Type of mounting	DIN-rail mounting (DIN EN 50022)			DIN-rail mounting (DIN EN 50022)		
Ambient operating temperature	-10 °C ... +70 °C			-10 °C ... +70 °C		
Storage temperature	-25 °C ... +85 °C			-25 °C ... +85 °C		
Dimensions (mm) W x H x L	51 x 133 x 120 Height from upper-edge of DIN 35 rail			67 x 133 x 120 Height from upper-edge of DIN 35 rail		
Wire connection	CAGE CLAMP® (WAGO 231 Series)			CAGE CLAMP® (WAGO 231 Series)		
Cross sections	0.08 mm² ... 2.5 mm² / AWG 28 ... 12 (THHN, THWN)			0.08 mm² ... 2.5 mm² / AWG 28 ... 12 (THHN, THWN)		
Stripped lengths	8 ... 9 mm / 0.33 in			8 ... 9 mm / 0.33 in		
Weight	622 g			790 g		
Approvals	EN 60950-1, EN 61204-3, EN 61204-7, UL 60950, UL 508			EN 60950-1, EN 61204-3, EN 61204-7, UL 60950, UL 508		

	<p>Output voltage 24 V DC; 10 A open circuit and short-circuit protected, adjustable output voltage, LED status indication, parallel connection possible, thermal overload protection</p>	<p>Output voltage 48 V DC; 1 A open circuit and short-circuit protected, adjustable output voltage, LED status indication, parallel connection possible</p>
--	--	--

- prepared for class I equipment
- natural convection cooling when horizontally mounted
- encapsulated, for use in switchgear cabinets

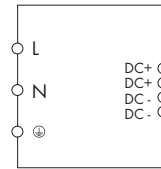
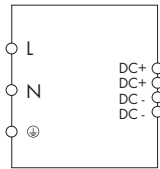

Description	Vo nom	Item No.	Pack. unit	Vo nom	Item No.	Pack. unit
Primary switch mode power supplies, for DIN 35 rail	24 V DC, SELV	787-632	1	48 V DC, SELV	787-613	1
Technical Data						
Nominal input voltage Vi nom	110 V ... 230 V AC			110 V ... 230 V AC		
Input voltage range	85 V ... 264 V AC; 90 V ... 350 V DC			90 V ... 264 V AC; 130 V ... 300 V DC (use of DC requires external protection)		
Frequency	50 Hz ... 60 Hz			50 Hz ... 60 Hz		
Input current Ii	2.8 A at 230 V AC (6 A at 115 V AC)			0.6 A typ. at 230 V AC		
Inrush current	< 30 A			< 50 A		
Discharge current	1 mA typ.					
Mains failure hold-up time	>20 ms at 230 V AC, 24 V DC, 10 A			> 20 ms at 230 V AC		
Internal/external fuse	6.3 A / 16 A recommended					
Nominal output voltage Vo nom	24 V DC, SELV			48 V DC, SELV		
Output voltage range	22.8 V ... 28.8 V DC adjustable			43.2 V ... 52.8 V DC adjustable		
Output current Io	10 A at 24 V DC			1 A at 48 V DC		
Residual ripple	< 100 mVpp			< 200 mVpp at 20 MHz		
Derating	-3 % / K (>50 °C)			-3 % / K (>60 °C)		
Adjustment accuracy	3 %			2 %		
Current limitation	from 1.2 x Ia			from 1.1 x Ia		
Efficiency	88 % typ.			85 % typ.		
Test voltage pri.-gr./pri.-sec./sec.-gr.	1.5 kV / 4.2 kV / 0.5 kV			4.2 kV		
Degree of protection	IP20 (EN 60529, 1991)			IP20		
Operational indication	LED green at Vo > DC 18 V / LED red at overcurrent			LED green (48 V o.k.)		
Type of mounting	DIN-rail mounting (DIN EN 50022)			DIN-rail mounting (DIN EN 50022)		
Ambient operating temperature	-10 °C ... +70 °C			-10 °C ... +70 °C		
Storage temperature	-25 °C ... +85 °C			-25 °C ... +85 °C		
Dimensions (mm) W x H x L	115 x 87 x 140			51 x 133 x 120		
Wire connection	Height from upper-edge of DIN 35 rail CAGE CLAMP® (WAGO 231 Series)			Height from upper-edge of DIN 35 rail CAGE CLAMP® (WAGO 231 Series)		
Cross sections	0.08 mm² ... 2.5 mm² / AWG 28 ... 12 (THHN, THWN)			0.08 mm² ... 2.5 mm² / AWG 28 ... 12 (THHN, THWN)		
Stripped lengths	8 ... 9 mm / 0.33 in			8 ... 9 mm / 0.33 in		
Weight	950 g			690 g		
Approvals	EN 60950-1, EN 61204-3, EN 61204-7, UL 60950, UL 508			EN 60950-1, EN 61204-3, EN 61204-7		

Output voltage 48 V DC; 2 A
open circuit and short-circuit protected,
adjustable output voltage,
LED status indication,
parallel connection possible

Output voltage 48 V DC; 5 A
open circuit and short-circuit protected,
adjustable output voltage,
LED status indication,
parallel connection possible

- Thermal overload protection
- Parallel connection possible
- Prepared for class I equipment
- Natural convection cooling when horizontally mounted
- Encapsulated, for use in switchgear cabinets

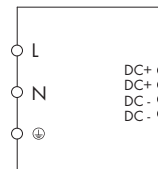
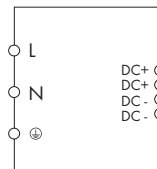

Description	Vo nom	Item No.	Pack. unit	Vo nom	Item No.	Pack. unit
Primary switch mode power supplies, for DIN 35 rail	48 V DC, SELV	787-623	1	48 V DC	787-633	1
Technical Data						
Nominal input voltage Vi nom	110 V ... 230 V AC			110 V ... 230 V AC		
Input voltage range	90 V ... 264 V AC; 130 V ... 300 V DC (use of DC requires external protection)			176 V ... 264 V AC / 90 V ... 132 V		
Frequency	50 Hz ... 60 Hz			50 Hz ... 60 Hz		
Input current Ii	1.2 A typ. at 230 V AC			2.8 A typ. at 230 V AC / 6.0 A typ. at 115 V AC		
Inrush current	< 50 A			< 50 A		
Mains failure hold-up time	> 20 ms at 230 V AC			> 20 ms at 230 V AC		
Nominal output voltage Vo nom	48 V DC, SELV			48 V DC		
Output voltage range	42 V ... 52.8 V DC adjustable			43.2 V ... 52.8 V DC adjustable		
Output current Io	2 A at 48 V DC			5 A at 48 V DC		
Residual ripple	< 200 mVpp at 20 MHz			< 200 mVpp at 20 MHz		
Derating	-3 % / K (>55 °C)			-3 % / K (>50 °C)		
Adjustment accuracy	2 %			3 %		
Current limitation	from 1.1 x Ia			from 1.2 x Ia		
Efficiency	90 % typ.			85 % typ.		
Test voltage pri.-gr./pri.-sec./sec.-gr.	4.2 kV			4.2 kV		
Degree of protection	IP20			IP20		
Operational indication	LED green (48 V o.k.)			LED green (48 V o.k.)		
Type of mounting	DIN-rail mounting (DIN EN 50022)			DIN-rail mounting (DIN EN 50022)		
Ambient operating temperature	-10 °C ... +70 °C			-10 °C ... +70 °C		
Storage temperature	-25 °C ... +85 °C			-25 °C ... +85 °C		
Dimensions (mm) W x H x L	67 x 133 x 120			115 x 87 x 140		
Wire connection	Height from upper-edge of DIN 35 rail CAGE CLAMP® (WAGO 231 Series)			Height from upper-edge of DIN 35 rail CAGE CLAMP® (WAGO 231 Series)		
Cross sections	0.1 mm² ... 2.5 mm² / AWG 28 ... 12 0.5 mm² ... 10 mm² / AWG 20 ... 8 (THHN, THWN)			0.08 mm² ... 2.5 mm² / AWG 28 ... 12 (THHN, THWN)		
Stripped lengths	8 ... 9 mm / 0.33 in			8 ... 9 mm / 0.33 in		
Weight	800 g			940 g		
Approvals	EN 60950-1, EN 61204-3, EN 61204-7			EN 60950-1, EN 61204-3, EN 61204-7		

**Power supply for AS-Interface;
Input 115V/230V AC;
Output 30.5V DC; 3A**

- Min. cond. cross section acc. to AS-Interface specification: 1.5 mm²
- natural convection cooling when horizontally mounted
- encapsulated, for use in switchgear cabinets

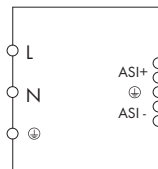

Description	Vo nom	Item No.	Pack. unit
Primary switch mode power supply, for DIN 35 rail	30.5 V DC (PELV)	787-692	1
Technical Data			
Nominal input voltage Vi nom	110 V ... 230 V AC		
Input voltage range	90 V ... 264 V AC; 130 V ... 300 V DC (use of DC requires external protection)		
Frequency	50 Hz ... 60 Hz		
Input current Ii	2 A at 115 V AC / 1 A at 230 V AC		
Inrush current	< 50 A (cold)		
Mains failure hold-up time	> 15 ms at 115 V AC / > 50 ms at 230 V AC		
Internal/external fuse	4 AT		
Nominal output voltage Vo nom	30.5 V DC (PELV)		
Output voltage range	26 V ... 33 V DC		
Output current Io	3 A at 30.5 V DC; 2.5 A at Vi < 97 V AC		
Residual ripple	< 300 mVpp to 20 MHz		
Mains / load regulation	< 750 mV		
Derating	-3 % / K (>55 °C)		
Current limitation	3.4 A typ.		
Efficiency	89 % typ.		
Test voltage pri.-gr./pri.-sec./sec.-gr.	4.2 kV		
Degree of protection	IP20		
Operational indication	LED green (operating condition at Vo)		
Type of mounting	DIN-rail mounting (DIN EN 50022)		
Ambient operating temperature	-10 °C ... +70 °C		
Storage temperature	-25 °C ... +85 °C		
Dimensions (mm) W x H x L	51 x 133 x 120 Height from upper-edge of DIN 35 rail		
Wire connection	CAGE CLAMP® (WAGO 231 Series)		
Cross sections	0.08 mm ² ... 2.5 mm ² / AWG 28 ... 12 (THHN, THWN)		
Stripped lengths	8 ... 9 mm / 0.33 in		
Weight	690 g		
Approvals	EN 60950-1, EN 61204-3, EN 61204-7, UL 60950, UL 508		

Output voltage 24 V DC; 2.5 A
open circuit and short-circuit protected,
adjustable output voltage,
LED status indication

Output voltage 24 V DC; 5 A
open circuit and short-circuit protected,
adjustable output voltage,
LED status indication

- prepared for class I equipment
- natural convection cooling when horizontally mounted
- encapsulated, for use in switchgear cabinets

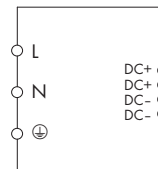
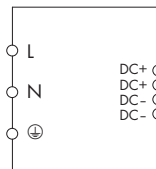

Description	Vo nom	Item No.	Pack. unit	Vo nom	Item No.	Pack. unit
Primary switch mode power supplies, for DIN 35 rail	24 V DC, SELV	787-712	1	24 V DC, SELV	787-722	1
Technical Data						
Nominal input voltage Vi nom	230 V AC			230 V AC		
Input voltage range	85 V ... 264 V AC*			85 V ... 264 V AC*		
	*with derating -3 % / V (< 90 V)			*with derating -0.8 % / V (< 110 V)		
Frequency	47 Hz ... 63 Hz			47 Hz ... 63 Hz		
Input current Ii	0.7 A typ. at 230 V AC			1.0 A typ. at 230 V AC		
Inrush current	< 30 Ap			< 30 Ap		
Mains failure hold-up time	> 20 ms at 230 V AC			> 20 ms at 230 V AC		
Nominal output voltage Vo nom	24 V DC, SELV			24 V DC, SELV		
Output voltage range	22 V ... 28 V DC adjustable			22 V ... 28 V DC adjustable		
Output current Io	2.5 A at 24 V DC			5 A at 24 V DC		
Residual ripple	< 100 mVpp to 20 MHz			< 100 mVpp to 20 MHz		
Derating	-3.3 % / K (>55 °C at 230 V AC)			-2.67 % / K (> 40 °C)		
Adjustment accuracy	1 %			1 %		
Current limitation	from 1.15 to 1.4 x Io			from 1.15 to 1.4 x Io		
Efficiency	82 % typ.			82 % typ.		
Test voltage pri.-gr./pri.-sec./sec.-gr.	1.5 kV / 3 kV / 0.5 kV			1.5 kV / 3 kV / 0.5 kV		
Degree of protection	IP20			IP20		
Operational indication	LED green (24 V DC o.k.), LED red (overload)			LED green (24 V DC o.k.), LED red (overload)		
Type of mounting	DIN-rail mounting (DIN EN 50022)			DIN-rail mounting (DIN EN 50022)		
Ambient operating temperature	-10 °C ... +70 °C			-10 °C ... +70 °C		
Storage temperature	-25 °C ... +85 °C			-25 °C ... +85 °C		
Dimensions (mm) W x H x L	50 x 92 x 136			75 x 92 x 136		
Wire connection	Height from upper-edge of DIN 35 rail CAGE CLAMP® (WAGO 745 Series)			Height from upper-edge of DIN 35 rail CAGE CLAMP® (WAGO 745 Series)		
Cross sections	0.08 mm² ... 4 mm² / AWG 28 ... 12 (THHN, THWN)			0.08 mm² ... 4 mm² / AWG 28 ... 12 (THHN, THWN)		
Stripped lengths	8 ... 9 mm / 0.33 in			8 ... 9 mm / 0.33 in		
Weight	470 g			740 g		
Approvals	EN 60950, EN 61000-6-2, EN 61000-6-3 UL 60950, UL 508* (* pending)			EN 60950, EN 61000-6-2, EN 61000-6-3 UL 60950, UL 508* (* pending)		

	Output voltage 24 V DC; 10 A open circuit and short-circuit protected, adjustable output voltage, LED status indication	
--	--	--

- prepared for class I equipment
- natural convection cooling when horizontally mounted
- encapsulated, for use in switchgear cabinets

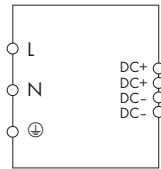

Description	Vo nom	Item No.	Pack. unit
Primary switch mode power supply, for DIN 35 rail	24 V DC, SELV	787-732	1
Technical Data			
Nominal input voltage Vi nom	230 V AC		
Input voltage range	85 V ... 264 V AC*		
	*with derating -0.8 % / V (< 110 V)		
Frequency	47 Hz ... 63 Hz		
Input current Ii	1.5 A typ. at 230 V AC		
Inrush current	< 30 Ap		
Mains failure hold-up time	> 20 ms at 230 V AC		
Nominal output voltage Vo nom	24 V DC, SELV		
Output voltage range	22 V ... 28 V DC adjustable		
Output current Io	10 A at 24 V DC		
Residual ripple	< 100 mVpp to 20 MHz		
Derating	-2.67 % / K (>55 °C at 230 V AC)		
Adjustment accuracy	1 %		
Current limitation	from 1.15 to 1.4 x Io		
Efficiency	82 % typ.		
Test voltage pri.-gr./pri.-sec./sec.-gr.	1.5 kV / 3 kV / 0.5 kV		
Degree of protection	IP20		
Operational indication	LED green (24 V DC o.k.), LED red (overload)		
Type of mounting	DIN-rail mounting (DIN EN 50022)		
Ambient operating temperature	-10 °C ... +70 °C		
Storage temperature	-25 °C ... +85 °C		
Dimensions (mm) W x H x L	110 x 92 x 136		
	Height from upper-edge of DIN 35 rail		
Wire connection	CAGE CLAMP® (WAGO 745 Series)		
Cross sections	0.08 mm² ... 4 mm² / AWG 28 ... 12 (THHN, THWN)		
Stripped lengths	8 ... 9 mm / 0.33 in		
Weight	1030 g		
Approvals	EN 60950, EN 61000-6-2, EN 61000-6-3 UL 60950, UL 508* (* pending)		

4 EPSITRON - Electronic Circuit Breakers

248

	Electronic circuit breaker 4-channel, 1 A ... 6 A DC, parametrizable	Electronic circuit breaker 4-channel, 1 A ... 10 A DC, parametrizable
--	---	--

- Electronic circuit breaker with 4 channels, parametrizable
- Time-delayed switching of channels
- Floating switch contact
- Current and voltage monitoring via RS-232 interface and LCD
- Watchdog functions with active signal ports



Description	Vo nom	Item No.	Pack. unit	Vo nom	Item No.	Pack. unit
Electronic circuit breakers, for DIN 35 rail	4 x 24 V DC	787-860	1	4 x 24 V DC	787-862	1

Technical Data						
Nominal input voltage Vi nom	24 V DC			24 V DC		
Input voltage range	18 ... 30 V DC			18 ... 30 V DC		
Internal/external fuse	6.3 AT			15 AT		
Nominal output voltage Vo nom	4 x 24 V DC			4 x 24 V DC		
Nominal current	4 x 1 ... 6 A DC (adjustable for each channel in 1 A steps)			4 x 1 ... 10 A DC (adjustable for each channel in 1 A steps)		
Voltage drop	120 mV at 6 A			120 mV at 6 A, 240 mV at 10 A		
Trip time	100 s (100 ms .. 600 s; adjustable)			100 s (100 ms .. 600 s; adjustable)		
Switch-on capacity	1000 µF per 1 A DC (max. 7000 µF)			1000 µF per 1 A DC (max. 7000 µF)		
Switch-on behavior	time-delayed channel switching (250 ms each)			time-delayed channel switching (250 ms each)		
Parallel operation of single channels	not permitted			not permitted		
Series connection of several devices	not permitted			not permitted		
Degree of protection	IP20			IP20		
Operational indication	LED green (all channels o.k.), LED yellow (warning), LED red (at least one channel has tripped)			LED green (all channels o.k.), LED yellow (warning), LED red (at least one channel has tripped)		
Signaling	LCD, 4 x signal output 24 V DC, 25 mA and 1 x floating relay contact 60 V DC, 3 A			LCD, 4 x signal output 24 V DC, 25 mA and 1 x floating relay contact 60 V DC, 3 A		
Remote input	Reactivation of all tripped channels via 18 V ... 30 V DC impulse for min. 50 ms			Reactivation of all tripped channels via 18 V ... 30 V DC impulse for min. 50 ms		
LineMonitor, parameter setting	via LCD and RS-232 serial interface			via LCD and RS-232 serial interface		
Type of mounting	DIN-rail mounting (EN 60715) in 2 positions			DIN-rail mounting (EN 60715) in 2 positions		
Ambient operating temperature	-10 °C ... +60 °C			-10 °C ... +60 °C		
Storage temperature	-25 °C ... +85 °C			-25 °C ... +85 °C		
Dimensions (mm) W x H x L	40 x 171 x 163			40 x 171 x 163		
Wire connection	Height from upper-edge of DIN 35 rail Input: (WAGO 831 Series) Output: (WAGO 231 Series)			Height from upper-edge of DIN 35 rail Input: (WAGO 831 Series) Output: (WAGO 231 Series)		
Cross sections	Input: 0.5 mm ² ... 10 mm ² / AWG 20 ... 8 Output: 0.08 mm ² ... 2.5 mm ² / AWG 28 ... 12			Input: 0.5 mm ² ... 10 mm ² / AWG 20 ... 8 Output: 0.08 mm ² ... 2.5 mm ² / AWG 28 ... 12		
Stripped lengths	Input: 13 ... 15 mm / 0.55 in Output: 8 ... 9 mm / 0.33 in			Input: 13 ... 15 mm / 0.55 in Output: 8 ... 9 mm / 0.33 in		
Weight	800 g			800 g		
Approvals	EN 60950, UL 508*, EN 61000-6-2, EN 61000-6-3 (* pending)			EN 60950, UL 508*, EN 61000-6-2, EN 61000-6-3 (* pending)		

	Electronic circuit breaker 4-channel, 1 A ... 8 A DC, parametrizable, active current limitation	
--	--	--

- Electronic circuit breaker with 4 channels, parametrizable
- Features active current limitation, reliably prevents voltage drops
- Time-delayed switching of channels
- Current and voltage monitoring via RS-232 interface and LCD
- Watchdog functions with active signal ports



Description	Vo nom	Item No.	Pack. unit
Electronic circuit breakers, for DIN 35 rail	4 x 24 V DC	787-861	1
Technical Data			
Nominal input voltage Vi nom	24 V DC		
Input voltage range	18 ... 30 V DC		
Internal/external fuse	15 AT		
Nominal output voltage Vo nom	4 x 24 V DC		
Nominal current	4 x 1 ... 8 A DC (adjustable for each channel in 1 A steps)		
Voltage drop	240 mV at 8 A		
Trip time	100 ms (100 ms .. 1.5 s; adjustable, depending on nominal current)		
Switch-on capacity	max. 20,000 µF		
Switch-on behavior	time-delayed channel switching (250 ms each)		
Parallel operation of single channels	not permitted		
Series connection of several devices	not permitted		
Trip current	1.1 x nominal current typ.		
Current limitation	1.5 x nominal current typ.		
Degree of protection	IP20		
Operational indication	LED green (all channels o.k.), LED yellow (warnings), LED red (at least one channel has tripped)		
Signaling	LCD, 4 x signal output 24 V DC, 25 mA via LCD and RS-232 serial interface		
LineMonitor, parameter setting			
Type of mounting	DIN-rail mounting [EN 60715] in 2 positions		
Ambient operating temperature	-10 °C ... +60 °C		
Storage temperature	-25 °C ... +85 °C		
Dimensions (mm) W x H x L	40 x 171 x 163 Height from upper-edge of DIN 35 rail		
Wire connection	Input: (WAGO 831 Series) Output: (WAGO 231 Series)		
Cross sections	Input: 0.5 mm ² ... 10 mm ² / AWG 20 ... 8 Output: 0.08 mm ² ... 2.5 mm ² / AWG 28 ... 12		
Stripped lengths	Input: 13 ... 15 mm / 0.55 in Output: 8 ... 9 mm / 0.33 in		
Weight	800 g		
Approvals	EN 60950, UL 2367*, EN 61000-6-2, EN 61000-6-3 (* pending)		

4 EPSITRON - UPS Charger and Controller

250

	UPS charger and controller 24 V DC, 10 A, parametrizable	UPS charger and controller 24 V DC, 20 A parametrizable
--	---	--

- Charger and controller for uninterruptible power supply (UPS)
- Current and voltage monitoring, as well as parameter setting via LCD and RS-232 interface
- Active signal outputs for watchdog functions
- Remote input for switching off buffered output
- Input for temperature control of connected battery

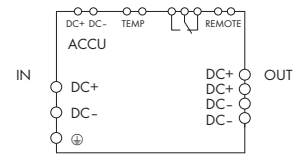
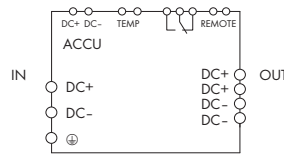

Description	Vo nom	Item No.	Pack. unit	Vo nom	Item No.	Pack. unit
UPS charger and controller, for DIN 35 rail	24 V DC	787-870	1	24 V DC	787-875	1

Technical Data						
Nominal input voltage Vi nom	24 V DC			24 V DC		
Input voltage range	20.4 V ... 28.8 V DC			20.4 V ... 28.8 V DC		
Input current Ii	0.1 A (no-load running); 0.8 A (charging); 10.8 A (max.)			0.1 A (no-load running); 1.5 A (charging); 21.5 A (max.)		
Inrush current	< 4 A (no load)			< 4 A (no load)		
Switch-on threshold (adjustable)	20 V ... 25.5 V DC			20 V ... 25.5 V DC		
Internal/external fuse	15 AT / -			15 AT / -		
Nominal output voltage Vo nom	24 V DC			24 V DC		
Output voltage range	Vi - 0.5 V DC (below switch-on threshold); 20 V ... 25.5 V DC (during buffer operation)			Vi - 1 V DC (below switch-on threshold); 20 V ... 25.5 V DC (buffer mode)		
Output current Io	10 A			20 A		
Current limitation	typ. 11 A ... 14 A			typ. 22 A ... 26 A		
Buffer time	10 s ... 600 s or constant (adjustable)			10 s ... 600 s or constant (adjustable)		
Final load voltage	26 V ... 29.5 V DC or temperature controlled (adjustable)			26 V ... 29.5 V DC or temperature controlled (adjustable)		
Charging current	max. 0.6 A			max. 1.0 A		
Degree of protection	IP20			IP20		
Operational indication	LED green (Vo), LED yellow (warning), LED red (error)			LED green (Vo), LED yellow (warning), LED red (error)		
Signaling	LCD, 3 x signal output 24 V DC, 25 mA and 1 x floating relay contact 30 V DC, 1 A			LCD, 3 x signal output 24 V DC, 25 mA and 1 x floating relay contact 30 V DC, 1 A		
Remote input	to switch off buffer operation			to switch off buffer operation		
LineMonitor, parameter setting	via LCD and RS-232 serial interface			via LCD and RS-232 serial interface		
Type of mounting	DIN-rail mounting (EN 60715) in 2 positions			DIN-rail mounting (EN 60715) in 2 positions		
Ambient operating temperature	-10 °C ... +60 °C			-10 °C ... +60 °C		
Storage temperature	-25 °C ... +85 °C			-25 °C ... +85 °C		
Dimensions (mm) W x H x L	40 x 163 x 163			57 x 163 x 171		
Wire connection	Height from upper-edge of DIN 35 rail Input: (WAGO 231 Series) Output: (WAGO 231 Series)			Height from upper-edge of DIN 35 rail Input/Output: (WAGO 831 Series) Signalling: (WAGO 733 Series)		
Cross sections	Input: 0.08 mm ² ... 2.5 mm ² / AWG 28 ... 12 Output: 0.08 mm ² ... 2.5 mm ² / AWG 28 ... 12			Input/Output: 0.5 mm ² ... 10 mm ² / AWG 20 ... 8 Signalling: 0.08 mm ² ... 0.5 mm ² / AWG 28 ... 20		
Stripped lengths	Input: 8 ... 9 mm / 0.33 in Output: 8 ... 9 mm / 0.33 in			Input/Output: 13 ... 15 mm / 0.55 in Signalling: 5 ... 6 mm / 0.22 in		
Weight	800 g			1200 g		
Approvals	EN 60950, UL 60950*, UL 508*, EN 61000-6-2, EN 61000-6-3 (* pending)			EN 60950, UL 60950*, UL 508*, EN 61000-6-2, EN 61000-6-3 (* pending)		

	Capacitive buffer module 24 V DC, 10 A	Capacitive buffer module 24 V DC, 20 A
--	---	---

- Capacitive buffer module bridges short duration voltage drops
- For uninterruptible power supply
- Potential-free contact for charge condition monitoring

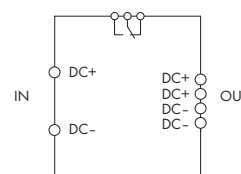
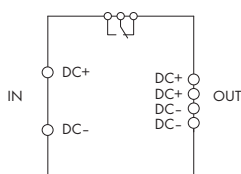

Description	Vo nom	Item No.	Pack. unit	Vo nom	Item No.	Pack. unit
Capacitive buffer modules, for DIN 35 rail	24 V DC	787-880	1	24 V DC	787-881	1

Technical Data

Nominal input voltage Vi nom	24 V DC	24 V DC
Input voltage range	20 V ... 30 V DC	20 V ... 30 V DC
Input current Ii	60 mA (no-load running); 1 A (charging); 11 A (max.)	60 mA (no-load running); 1 A (charging); 22 A (max.)
Switch-on threshold (adjustable)	20 V ... 24 V DC	20 V ... 24 V DC
Charging time	typ. 5 minutes	typ. 5 minutes
Nominal output voltage Vo nom	24 V DC	24 V DC
Output voltage range	Vi - 0.5 V DC (below switch-on threshold); 20.4 V ... 24 V DC (during buffer operation)	Vi - 1 V DC (below switch-on threshold); 20.4 V ... 24 V DC (during buffer operation)
Output current Io	10 A	20 A
Current limitation	electronic, typ. 11 A	electronic, typ. 22 A
Buffer time	0.06 s ... 7.2 s (depends on load current and switch-on threshold)	0.17 s ... 16.5 s (depends on load current and switch-on threshold)
Parallel operation	yes	yes
Power loss Pv	1.5 W open circuit 6.5 W nominal load	1.5 W open circuit 15 W nominal load
Feedback voltage	max. 35 V DC	max. 35 V DC
Degree of protection	IP20	IP20
Operational indication	LED green (Va > 20 V), LED yellow (charging), LED red (Va < 20 V)	LED green (Va > 20 V), LED yellow (charging), LED red (Va < 20 V)
Signaling	1 x floating relay contact 30 V DC, 1 A	1 x floating relay contact 30 V DC, 1 A
Type of mounting	DIN-rail mounting (EN 60715) in 2 positions	DIN-rail mounting (EN 60715) in 2 positions
Ambient operating temperature	-10 °C ... +50 °C	-10 °C ... +50 °C
Storage temperature	-10 °C ... +60 °C	-10 °C ... +60 °C
Dimensions (mm) W x H x L	57 x 179 x 163	57 x 179 x 181
Wire connection	Input/Output: (WAGO 231 Series) Relay: (WAGO 231 Series)	Input/Output: (WAGO 831 Series) Relay: (WAGO 231 Series)
Cross sections	Input/Output: 0.08 mm ² ... 2.5 mm ² / AWG 28 ... 12 Relay: 0.08 mm ² ... 2.5 mm ² / AWG 28 ... 12	Input/Output: 0.5 mm ² ... 10 mm ² / AWG 20 ... 8 Relay: 0.08 mm ² ... 2.5 mm ² / AWG 28 ... 12
Stripped lengths	Input/Output: 8 ... 9 mm / 0.33 in Relay: 8 ... 9 mm / 0.33 in	Input/Output: 13 ... 15 mm / 0.55 in Relay: 8 ... 9 mm / 0.33 in
Weight	1000 g	1000 g
Approvals	EN 60950, UL 60950*, UL 508*, EN 61000-6-2, EN 61000-6-3 (* pending)	EN 60950, UL 60950*, UL 508*, EN 61000-6-2, EN 61000-6-3 (* pending)

	Redundancy module 24 V DC, 20 A	
--	--	--

- Redundancy module with 2 inputs for decoupling
- 2 power supplies
- For redundant or uninterruptible power supply
- With potential-free contact for input voltage monitoring

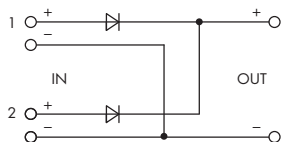

Description	Vo nom	Item No.	Pack. unit
Redundancy module, for DIN 35 rail	24 V DC	787-885	1
Technical Data			
Nominal input voltage Vi nom	2 x 24 V DC		
Input voltage range	18 V ... 30 V DC		
Input current Ii	2 x 20 A, max. 1 x 40 A		
Nominal output voltage Vo nom	24 V DC		
Output current Io	20 A, max. 40 A		
Parallel operation	yes		
Power loss Pv	1.5 W open circuit		
Efficiency	14 W nominal load (20 A) / 26 W nominal load (40 A)		
Degree of protection	97 % typ.		
Operational indication	IP20		
Signaling	LED green (Vo), 2 x LED yellow (Vi)		
Type of mounting	1 x floating relay contact 30 V DC, 1 A		
Ambient operating temperature	DIN-rail mounting (EN 60715) in 2 positions		
Storage temperature	-10 °C ... +60 °C		
Dimensions (mm) W x H x L	-25 °C ... +85 °C		
Wire connection	40 x 163 x 181		
Cross sections	Height from upper-edge of DIN 35 rail		
Stripped lengths	Input/Output: (WAGO 831 Series)		
Weight	Relay: (WAGO 231 Series)		
Approvals	Input/Output: 0.5 mm ² ... 10 mm ² / AWG 20 ... 8		
	Relay: 0.08 mm ² ... 2.5 mm ² / AWG 28 ... 12		
	Input/Output: 13 ... 15 mm / 0.55 in		
	Relay: 8 ... 9 mm / 0.33 in		
	800 g		
	EN 60950, UL 60950*, UL 508*, EN 61000-6-2, EN 61000-6-3 (* pending)		

4 Rail-Mounted Modules - Constant Voltage Sources

258

	<p>24 V DC; 3 A Input 27 V ... 35 V DC</p> <p>Mounting feet for DIN 35 rail</p>	<p>24 V DC; 3 A Input 24 V AC +10 %, 50 Hz ... 60 Hz</p> <p>Mounting carrier for DIN 35 rail</p>
--	--	---

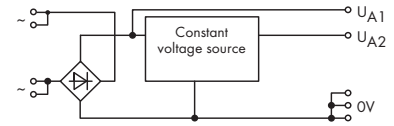
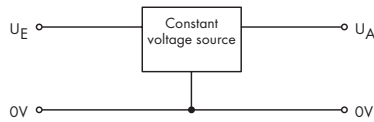

Description	Item No.	Pack. Unit	Item No.	Pack. Unit
Constant voltage source 24 V DC	289-907	1	288-800	1

Technical Data				
Input voltage	27 V ... 35 V DC		24 V AC +10%	
Output voltage	24 V DC (± 10 %)		24 V DC (± 10 %)	
Nominal output current	3 A		3 A	
Ambient operating temperature	-25 °C ... +40 °C		-25 °C ... +40 °C	
Weight	88 g		209 g	
Dimensions (mm) W x H x L	78.5 x 39 x 66		140 x 44 x 85	
Wire connection	Height from upper-edge of DIN 35 rail CAGE CLAMP® (236 Series)		Height from upper-edge of DIN 35 rail CAGE CLAMP® (236 Series)	
Cross sections	0.08 mm² ... 2.5 mm² / AWG 28 ... 12 (THHN, THWN)		0.08 mm² ... 2.5 mm² / AWG 28 ... 12 (THHN, THWN)	
Stripped lengths	5 ... 6 mm / 0.22 in		5 ... 6 mm / 0.22 in	
Accessories				
WMB Multi marking system for mounting carrier			see page 323	
Marker strips for mounting carrier			white 709-198 / translucent 709-196	

4 Rail-Mounted Modules - Power Supplies

260

	115 V AC / 24 V DC; 0.5 A Output voltage indication by LED Mounting carrier for DIN 35 rail	230 V AC / 24 V DC; 0.5 A Output voltage indication by LED Mounting carrier for DIN 35 rail
--	--	--

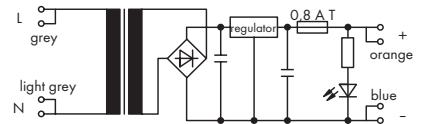
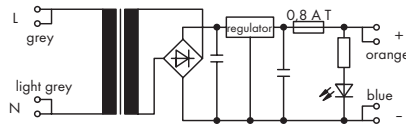
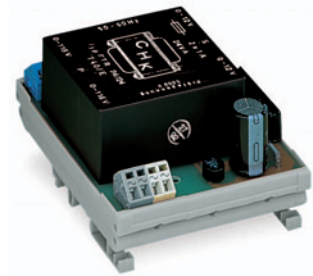
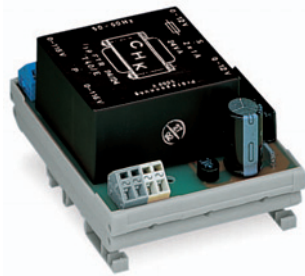

Description	Item No.	Pack. Unit	Item No.	Pack. Unit
Power supply, with universal mounting carrier	288-809	1	288-810	1

Technical Data

Nominal input voltage V_i nom	115 V AC	230 V AC
Input voltage range	$\pm 10\%$	$\pm 10\%$
Frequency	50 Hz ... 60 Hz	50 Hz ... 60 Hz
Power consumption at nominal load	30 VA	30 VA
Nominal output voltage V_o nom	24 V DC	24 V DC
Output voltage range	$\pm 4\%$	$\pm 4\%$
Output current I_o	0.5 A	0.5 A
Residual ripple	≤ 10 mVss	≤ 10 mVss
Output fuse	0.8 A slow	0.8 A slow
Ambient operating temperature	0 °C ... +50 °C	0 °C ... +50 °C
Weight	579 g	552 g
Dimensions (mm) W x H x L	77 x 52 x 106	77 x 52 x 106
Wire connection	Height from upper-edge of DIN 35 rail CAGE CLAMP® (236 Series)	Height from upper-edge of DIN 35 rail CAGE CLAMP® (236 Series)
Cross sections	0.08 mm² ... 2.5 mm² / AWG 28 ... 12 (THHN, THWN)	0.08 mm² ... 2.5 mm² / AWG 28 ... 12 (THHN, THWN)
Stripped lengths	5 ... 6 mm / 0.22 in	5 ... 6 mm / 0.22 in
Approvals	Transformer acc. to VDE 0551	Transformer acc. to VDE 0551
Accessories		
WMB Multi marking system for mounting carrier	see page 323	see page 323
Marker strips for mounting carrier	white 709-198 / translucent 709-196	white 709-198 / translucent 709-196

	<p>230 V AC / 12 V DC; 0.5 A Output voltage indication by LED</p> <p>Mounting carrier for DIN 35 rail</p>	<p>115 V AC / 24 V DC; 2 A Output voltage indication by LED</p> <p>Mounting carrier for DIN 35 rail</p>
--	--	--

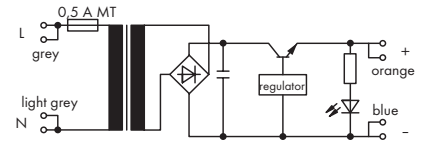
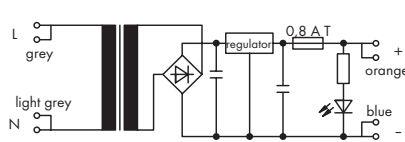
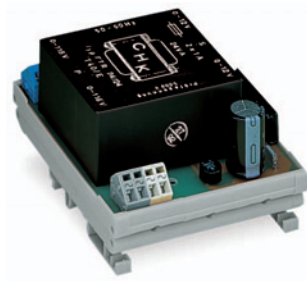

Description	Item No.	Pack. Unit	Item No.	Pack. Unit
Power supply, with universal mounting carrier	288-808	1	288-813	1

Technical Data

Nominal input voltage V_i nom	230 V AC	115 V AC
Input voltage range	$\pm 10\%$	$\pm 10\%$
Frequency	50 Hz ... 60 Hz	50 Hz ... 60 Hz
Power consumption at nominal load	23 VA	80 VA
Nominal output voltage V_o nom	12 V DC	24 V DC
Output voltage range	$\pm 4\%$	$\pm 10\%$
Output current I_o	0.5 A	2 A
Residual ripple	≤ 10 mVss	≤ 80 mVss
Input fuse	0.8 A slow	0.8 A medium-slow
Output fuse	0.8 A slow	electronic, short-circuit protected
Short-circuit current		2.5 A
Ambient operating temperature	0 °C ... +50 °C	0 °C ... +40 °C
Weight	574 g	1969 g
Dimensions (mm) W x H x L	77 x 52 x 106	182 x 98 x 106
Wire connection	Height from upper-edge of DIN 35 rail CAGE CLAMP® (236 Series)	Height from upper-edge of DIN 35 rail CAGE CLAMP® (256 Series)
Cross sections	0.08 mm ² ... 2.5 mm ² / AWG 28 ... 12 (THHN, THWN)	0.08 mm ² ... 2.5 mm ² / AWG 28 ... 12 (THHN, THWN)
Stripped lengths	5 ... 6 mm / 0.22 in	5 ... 6 mm / 0.22 in
Approvals	Transformer acc. to VDE 0551	Transformer acc. to VDE 0551

Accessories

WMB Multi marking system for mounting carrier	see page 323	see page 323
Marker strips for mounting carrier	white 709-198 / translucent 709-196	white 709-198 / translucent 709-196

4 Rail-Mounted Terminal Blocks with DC/DC Converter

264

	DC/DC converter 24 V / 5 V, 0.5 A DC	DC/DC converter 24 V / 10 V, 0.5 A DC
--	---	--

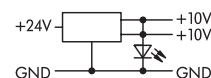
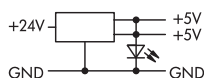
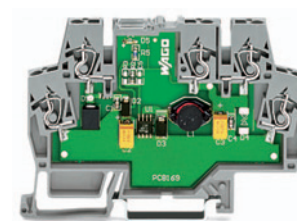
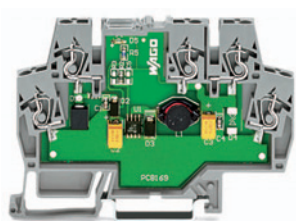
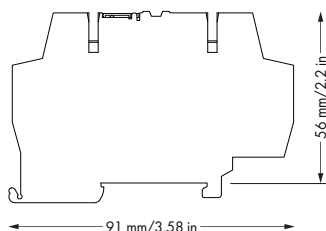

Description	V _N / V _O	Item No.	Pack. Unit	V _N / V _O	Item No.	Pack. Unit
DC/DC converter, for DIN 35 rail	24 V DC / 5 V DC ± 2 %	859-801	1	24 V DC / 10 V DC ± 2 %	859-802	1

Technical Data

Nominal input voltage (V _N)	24 V DC	24 V DC
Input voltage range	10 V ... 30 V DC	15 V ... 30 V DC
Output voltage	5 V DC ± 2 %	10 V DC ± 2 %
Output current (max.)	500 mA	500 mA
Line regulation, max. (full load, over input voltage range)	2 %	0.5 %
Max. load regulation (no load to full load, nominal input)	0.5 %	0.7 %
Efficiency at full load (24 V DC in)	70 %	85 %
Output noise peak-to-peak max. (20 MHz bandwidth)	150 mV	20 mV
Switching frequency	200 kHz (nominal)	200 kHz (nominal)
Isolation	non-isolated	non-isolated
Reverse voltage protection, input	yes	yes
Minimum load requirement	no	no
Max. transient recovery time (recovery time for load change from 25 % to 75% of full load)	40 μs	500 μs
Max. startup time (24 V DC in, full load)	3 ms	3 ms
Max. hold time (nominal input voltage, full load)	1 ms	500 μs
Input fuse	TVS diode	TVS diode
Output short circuit protection	temporary (short-circuit of the output for 1 minute without damage to the device)	temporary (short-circuit of the output for 1 minute without damage to the device)
Temperature coefficient	70 ppm/°C	100 ppm/°C
Ambient operating temperature	0 °C ... +40 °C	-25 °C ... +55 °C
Dimensions (mm) W x H x L	6 x 56 x 91	6 x 56 x 91
Wire connection	Height from upper-edge of DIN 35 rail CAGE CLAMP®	Height from upper-edge of DIN 35 rail CAGE CLAMP®
Cross sections	0.08 mm ² ... 2.5 mm ² / AWG 28 ... 14	0.08 mm ² ... 2.5 mm ² / AWG 28 ... 14
Stripped lengths	5 ... 6 mm / 0.22 in	5 ... 6 mm / 0.22 in

	DC/DC converter 12 V / 24 V, 250 mA DC	DC/DC converter 24 V / 12 V, 0.5 A DC
--	---	--

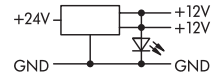
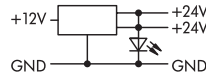
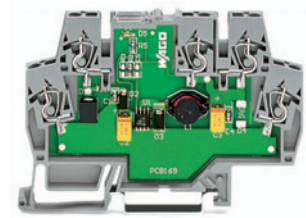
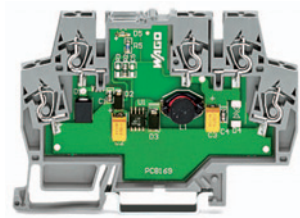
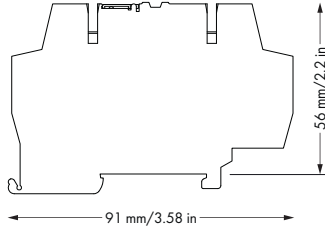

Description	V _N / V _O	Item No.	Pack. Unit	V _N / V _O	Item No.	Pack. Unit
DC/DC converter, for DIN 35 rail	12 V DC / 24 V DC ± 1 %	859-804	1	24 V DC / 12 V DC ± 2 %	859-805	1

Technical Data

	12 V DC / 24 V DC ± 1 %	24 V DC / 12 V DC ± 2 %
Nominal input voltage (V _N)	12 V DC	24 V DC
Input voltage range	8 V ... 16 V DC	15 V ... 30 V DC
Output voltage	24 V DC ± 1 %	12 V DC ± 2 %
Output current (max.)	250 mA	500 mA
Line regulation, max. (full load, over input voltage range)	0.5 %	0.5 %
Max. load regulation (no load to full load, nominal input)	0.5 %	0.7 %
Efficiency at full load (24 V DC in)	83 %	85 %
Output noise peak-to-peak max. (20 MHz bandwidth)	40 mV	20 mV
Switching frequency	1.2 MHz (nominal)	200 kHz (nominal)
Isolation	non-isolated	non-isolated
Reverse voltage protection, input	yes	yes
Minimum load requirement	no	no
Max. transient recovery time (recovery time for load change from 25 % to 75% of full load)	50 µs	500 µs
Max. startup time (24 V DC in, full load)	8 ms	3 ms
Max. hold time (nominal input voltage, full load)	500 µs	500 µs
Input fuse	TVS diode	TVS diode
Output short circuit protection	fuse	temporary (short-circuit of the output for 1 minute without damage to the device)
Temperature coefficient	100 ppm/°C	100 ppm/°C
Ambient operating temperature	-25 °C ... +55 °C	-25 °C ... +55 °C
Dimensions (mm) W x H x L	6 x 56 x 91	6 x 56 x 91
Wire connection	Height from upper-edge of DIN 35 rail CAGE CLAMP®	Height from upper-edge of DIN 35 rail CAGE CLAMP®
Cross sections	0.08 mm ² ... 2.5 mm ² / AWG 28 ... 14	0.08 mm ² ... 2.5 mm ² / AWG 28 ... 14
Stripped lengths	5 ... 6 mm / 0.22 in	5 ... 6 mm / 0.22 in

4 Rail-Mounted Modules - DC/DC Converter

266

	24 V / 24 V; 0.21 A DC	24 V / 18 V; 0.4 A DC
	Mounting feet for DIN 35 rail	Mounting carrier for DIN 35 rail

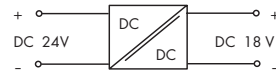
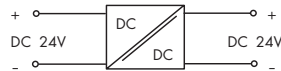
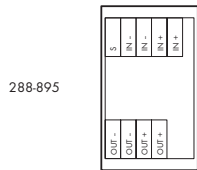
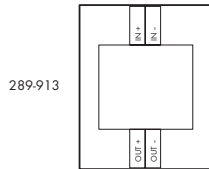

Description	Item No.	Pack. Unit	Item No.	Pack. Unit
DC/DC converter	289-913	1	288-895	1

Technical Data				
Input voltage	24 V DC		24 V DC	
Input voltage range	± 10 %		18 V ... 36 V DC	
Output voltage	24 V DC (± 3 %)		18 V DC (± 1 %)	
Nominal output current	210 mA		400 mA	
Peak output current	315 mA			
Efficiency	65 % ... 75 %		82 %	
Test voltage input/output	DC 500 V		DC 1500 V	
Short circuit protection	Thermal cut-out		permanent	
Ambient operating temperature	-25 °C ... +40 °C		-25 °C ... +70 °C	
Weight	77 g		75.9 g	
Dimensions (mm) W x H x L	83 x 25 x 77		50 x 25 x 85	
Wire connection	Height from upper-edge of DIN 35 rail CAGE CLAMP® (236 Series)		Height from upper-edge of DIN 35 rail CAGE CLAMP® (256 Series)	
Cross sections	0.08 mm² ... 2.5 mm² / AWG 28 ... 12 (THHN, THWN)		0.08 mm² ... 2.5 mm² / AWG 28 ... 12 (THHN, THWN)	
Stripped lengths	5 ... 6 mm / 0.22 in		5 ... 6 mm / 0.22 in	
EMC CE-Immunity to interference			acc. to EN 50082-2 (1996) * * Only in conjunction with DALI/DSI Master Module 750-641	
EMC CE-Emission of interference			acc. to EN 50081-1 (1993) * * Only in conjunction with DALI/DSI Master Module 750-641	
Accessories				
WMB Multi marking system for mounting carrier			see page 323	
Marker strips for mounting carrier			white 709-198 / translucent 709-196	

WAGO Application: Lighting Control System, easyCredit Stadium in Nuremberg, Germany

WAGO Products:
WAGO-I/O-SYSTEM with ETHERNET Controllers,
Power Supplies Units and
Rail-Mounted Terminal Blocks

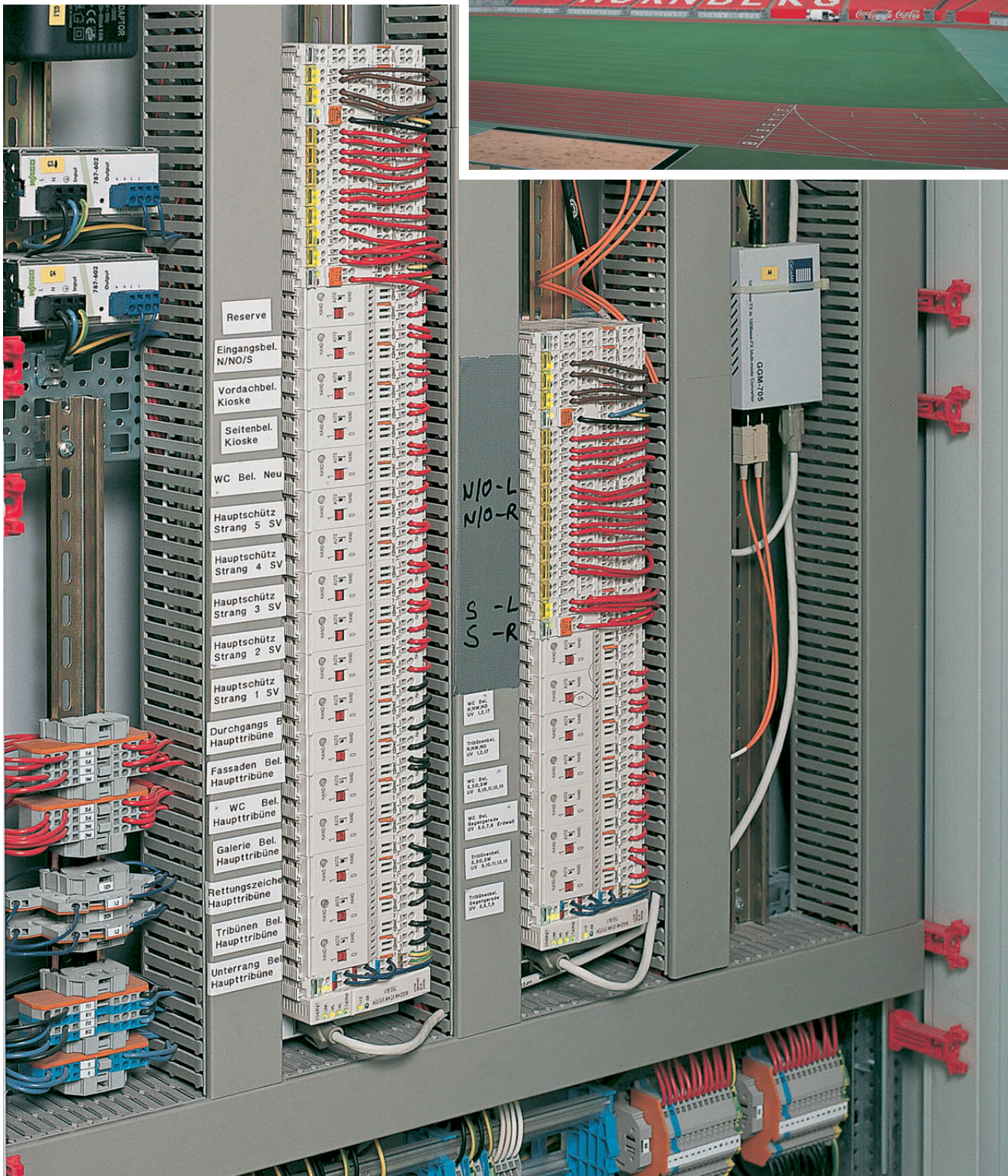

5

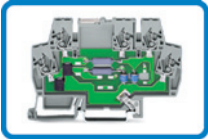

792 Series

Rail-Mounted Terminal Blocks with Overvoltage Protection
Accessories, 792 Series

270 - 272
273



280/870 Series

Rail-Mounted Terminal Blocks with Overvoltage Protection

274 - 277



286 Series

Pluggable Modules - Surge Suppression Devices
Pluggable Modules - Surge Suppression Devices

278 - 279
280 - 283

Overvoltage protection for information technology systems ME24 24 V DC; for protection of 2 single lines (line/protected ground), unbalanced interfaces as well as RS-485 and RS-422 interfaces

Overvoltage protection for information technology systems MD24 24 V DC; for protection of balanced interfaces (line/line) with electrical isolation (telecommunications)

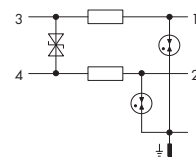
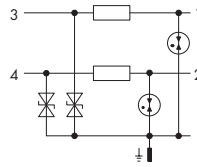
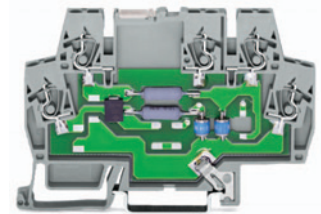
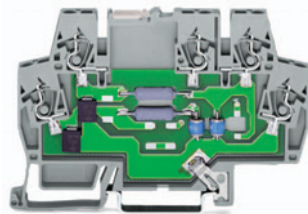
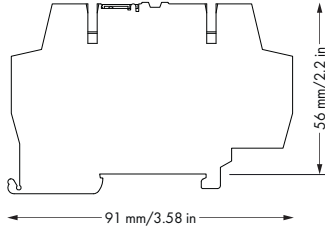

The coordination characteristics give information about the let-through energy of the overvoltage protector and the protection capacity.

Description	Nominal Voltage	Item No.	Pack. Unit	Nominal Voltage	Item No.	Pack. Unit
Overvoltage protection in terminal block, for DIN 35 Rail	24 V DC	792-800	1	24 V DC	792-801	1
Technical Data						
	Accessories see page 273			Accessories see page 273		
Nominal voltage	DC 24 V			DC 24 V		
Max. cont. operating voltage	33 V DC / 23 V AC			33 V DC / 23 V AC		
Nominal current	0.5 A			0.5 A		
Nominal discharge current I_{SN} (8/20) μ s	5 kA per line ; 10 kA total			5 kA per line ; 10 kA total		
Voltage protection level at I_{N} category C2	≤ 65 V (line/protected ground); ≤ 110 V (line/line)			≤ 50 V (line/line); ≤ 750 V (line/protected ground)		
Voltage protection level at 1 kV/ μ s category C3	≤ 45 V (line/protected ground); ≤ 90 V (line/line)			≤ 45 V (line/line); ≤ 650 V (line/protected ground)		
Coordination characteristics	X / 1			X / 1		
Series impedance R / line	1.8 Ω			1.8 Ω		
Response time t_a	≤ 1 ns			≤ 100 ns (line/protected ground); ≤ 1 ns (line/line)		
Limiting frequency	6 MHz line/protected ground			6 MHz line/protected ground		
Capacitance C	≤ 1.0 nF (line/protected ground); ≤ 0.5 nF (line/line)			≤ 5 pF (line/protected ground); ≤ 1 nF (line/line)		
Degree of protection	IP00			IP00		
Degree of protection with end and intermediate plate	IP20			IP20		
Operating temperature	-40 °C ... +80 °C			-40 °C ... +80 °C		
Storage temperature	-40 °C ... +80 °C			-40 °C ... +80 °C		
Dimensions (mm) W x H x L	6 x 56 x 91			6 x 56 x 91		
Wire connection	Height from upper-edge of DIN 35 rail CAGE CLAMP®			Height from upper-edge of DIN 35 rail CAGE CLAMP®		
Cross sections	0.08 mm ² ... 2.5 mm ² / AWG 28 ... 14			0.08 mm ² ... 2.5 mm ² / AWG 28 ... 14		
Stripped lengths	5 ... 6 mm / 0.22 in			5 ... 6 mm / 0.22 in		
Approvals	IEC 61643-21			IEC 61643-21		

	<p>Overvoltage protection for information technology systems SD24 24 V DC; for protection of supply lines (power supply units)</p>	<p>Overvoltage protection for information technology systems MDEX24 24 V DC; for protection in intrinsically safe circuits</p>
--	---	---

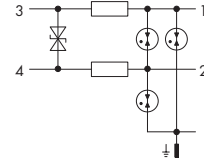
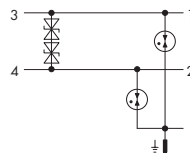
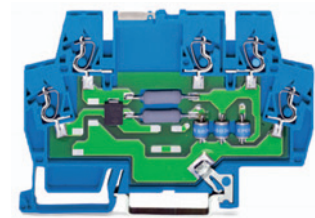
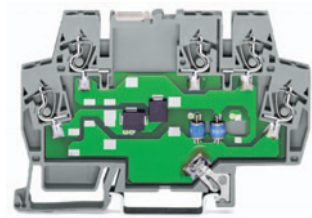
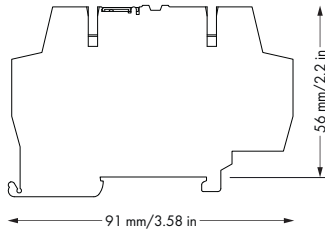

The coordination characteristics give information about the let-through energy of the overvoltage protector and the protection capacity.

Description	Nominal Voltage	Item No.	Pack. Unit	Nominal Voltage	Item No.	Pack. Unit
Overvoltage protection in terminal block, for DIN 35 Rail	24 V DC	792-802	1	24 V DC	792-803	1

Technical Data

Accessories see page 273

Accessories see page 273

Nominal voltage	DC 24 V	DC 24 V
Max. cont. operating voltage	33 V DC / 23 V AC	33 V DC / 23 V AC
Max. input voltage acc. to EN 50020 U _i		30 V
Max. input current acc. to EN 50020 I _i		0.5 A
Nominal current	10 A	0.5 A
Nominal discharge current I _{SN} (8/20) μs	5 kA (line/protected ground); 300 A (line/line)	5 kA per line ; 10 kA total
Voltage protection level at I _N category C2	≤ 50 V (line/line); ≤ 750 V (line/protected ground)	≤ 1500 V (line/protected ground); ≤ 50 V (line/line)
Voltage protection level at 1 kV/μs category C3	≤ 45 V (line/line); ≤ 650 V (line/protected ground)	≤ 1400 V (line/protected ground); ≤ 45 V (line/line)
Coordination characteristics	X / 1	X / 1
Series impedance R / line		1.8 Ω
Response time t ₀	≤ 100 ns (line/protected ground); ≤ 1 ns (line/line)	≤ 100 ns (line/protected ground); ≤ 1 ns (line/line)
Limiting frequency	7 MHz	6 MHz
Capacitance C	≤ 12 pF (line/protected ground); ≤ 1 nF (line/line)	≤ 6 pF (line/protected ground); ≤ 1 nF (line/line)
Degree of protection	IP00	IP00
Degree of protection with end and intermediate plate	IP20	IP20
Operating temperature	-40 °C ... +80 °C	-40 °C ... +80 °C
Storage temperature	-40 °C ... +80 °C	-40 °C ... +80 °C
Dimensions (mm) W x H x L	6 x 56 x 91	6 x 56 x 91
Wire connection	Height from upper-edge of DIN 35 rail	Height from upper-edge of DIN 35 rail
Cross sections	CAGE CLAMP®	CAGE CLAMP®
Stripped lengths	0.08 mm ² ... 2.5 mm ² / AWG 28 ... 14	0.08 mm ² ... 2.5 mm ² / AWG 28 ... 14
Approvals	5 ... 6 mm / 0.22 in	5 ... 6 mm / 0.22 in
	IEC 61643-21	IEC 61643-21

Operating tool



Wire connection

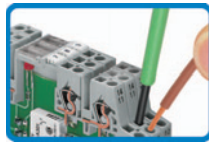

Marking pen with fibre tip



Test pin



End and intermediate plate



Description		Item No.	Pack. Unit
End and intermediate plate; 1 mm / 0.039 in thick, gray		859-525	100 (4x25)
Test pin; Ø 1 mm / 0.039 in; test wire for sold. onto test plug		859-500	1 (1x1)
Marking pen	for permanent marking	210-110	1
Operating tool, with partially insulated shaft	Type 2, blade (3.5 x 0.5) mm	210-720	1

Push-in type jumper bar



Commoning

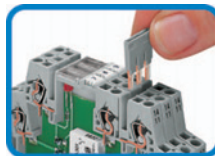

Description		Item No.	Pack. Unit
Push-in type jumper bars, light gray, insulated, 18 A	2-way	859-402	200 (8x25)
	3-way	859-403	200 (8x25)
	4-way	859-404	200 (8x25)
	5-way	859-405	200 (8x25)
	6-way	859-406	100 (4x25)
	7-way	859-407	100 (4x25)
	8-way	859-408	100 (4x25)
	9-way	859-409	100 (4x25)
	10-way	859-410	100 (4x25)
	Item no. suffix for colored push-in type jumper bars	yellow	... /000-029
red		... /000-005	
blue		... /000-006	

Miniature quick marking card



Marking



Description		Item No.	Pack. Unit
Miniature WSB Quick marking system	plain	248-501	5 cards
Marking software and printer/plotter see Section 8			
Marking	1 ... 10 (10 x)	248-502	5 cards
	11 ... 20 (10x)	248-503	5 cards
	21 ... 30 (10x)	248-504	5 cards
	31 ... 40 (10x)	248-505	5 cards
	41 ... 50 (10 x)	248-506	5 cards
	1 ... 50 (2 x)	248-566	5 cards
	K 1 ... K 10 (10 x)	248-450	5 cards
	K 11 ... K 20 (10 x)	248-451	5 cards
	K 100 (10 x)	248-452	5 cards
	U 1 ... U 10 (10 x)	248-453	5 cards
U 11 ... U 20 (10 x)	248-454	5 cards	
U 100 (10 x)	248-455	5 cards	
10 strips with 10 markers, white with black printing			

	With varistor V_{BN} AC/DC 24 V ... 110/120 V; I_{SN} 60 A ... 130 A Rated current 20 A Terminal block width 5 mm/0.197 in	With suppressor diode V_{BN} AC/DC 24 V ... AC 230 V; I_{SN} 11 A ... 122 A Rated current 20 A Terminal block width 5 mm/0.197 in
--	---	--

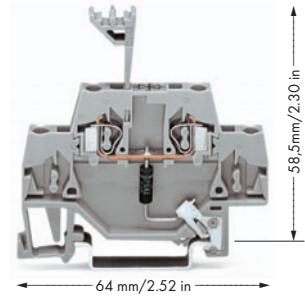
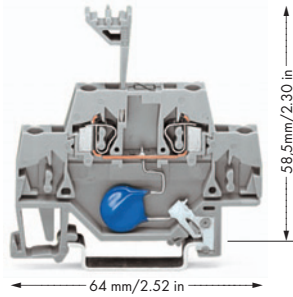
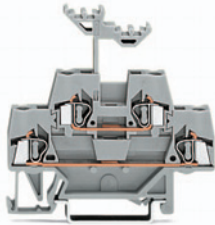

Through terminal blocks with the same shape see Full Line Catalog Volume 1

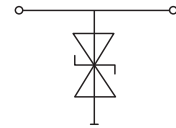
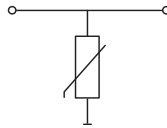

Description	V_N	Item No.	Pack. Unit	V_N	Item No.	Pack. Unit
Terminal block with surge suppression device and direct connection to DIN 35 rail	24 V DC	280-502/281-609	50	24 V DC	280-502/281-602	50
	48 V DC	280-502/281-610	50	48 V DC	280-502/281-603	50
	60 V DC	280-502/281-611	50	60 V DC	280-502/281-604	50
	115 V DC	280-502/281-612	50	115 V DC	280-502/281-605	50
	24 V AC	280-502/281-613	50	24 V AC	280-502/281-606	50
	110/120 V AC	280-502/281-614	50	110/120 V AC	280-502/281-607	50
				230 V AC	280-502/281-608	50

Technical Data	V_N	Max. Operating Voltage $V_{B \text{ max.}}$	Nominal Discharge Current I_{SN}	Max. Surge Current $I_{S \text{ max.}}$	Capacity	Protection Level
Terminal blocks with varistor	24 V DC	31 V DC	60 A	250 A	≤ 1.25 nF	77 V DC
	48 V DC	65 V DC	60 A	250 A	≤ 0.72 nF	135 V DC
	60 V DC	85 V DC	130 A	1.2 kA	≤ 0.48 nF	165 V DC
	115 V DC	150 V DC	130 A	1.2 kA	≤ 0.22 nF	300 V DC
	24 V AC	30 V AC	60 A	250 A	≤ 1.05 nF	93 V AC
	110/120 V AC	140 V AC	130 A	1.2 kA	≤ 0.18 nF	360 V AC
Terminal blocks with suppressor diode	24 V DC	30.8 V DC	122 A		≤ 1 nF	64 V DC
	48 V DC	58 V DC	59 A		≤ 0.63 nF	111 V DC
	60 V DC	77 V DC	44 A		≤ 0.55 nF	162 V DC
	115 V DC	136 V DC	25 A		≤ 0.4 nF	282 V DC
	24 V AC	28 V AC	86 A		≤ 0.8 nF	84 V AC
	110/120 V AC	133 V AC	18 A		≤ 0.35 nF	388 V AC
230 V AC	253 V AC	11 A		≤ 0.36 nF	706 V AC	

Technical Data		
Wire connection	CAGE CLAMP®	CAGE CLAMP®
Cross sections	0.08 mm² ... 2.5 mm² / AWG 28 ... 14	0.08 mm² ... 2.5 mm² / AWG 28 ... 14
Stripped lengths	8 ... 9 mm / 0.33 in	8 ... 9 mm / 0.33 in

Accessories	Item No.	Pack. Unit	Item No.	Pack. Unit
 End and Intermediate Plate, 2.5 mm/0.098 in thick	orange	280-341	100 (4*25)	orange 280-341 100 (4*25)
	gray	280-340	100 (4*25)	gray 280-340 100 (4*25)

	<p>With varistor V_{BN} AC/DC 24 V ... AC 230 V; I_{SN} 300 A ... 1 kA Rated current 20 A</p> <p>Terminal block width 10 mm/0.394 in</p>	<p>With suppressor diode V_{BN} AC/DC 24 V ... AC 230 V; I_{SN} 37 A ... 305 A Rated current 20 A</p> <p>Terminal block width 10 mm/0.394 in</p>
--	--	--

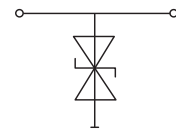
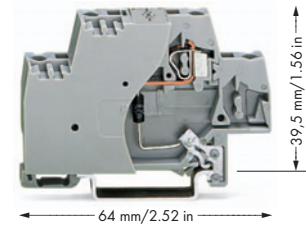
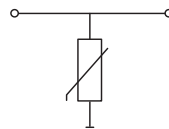
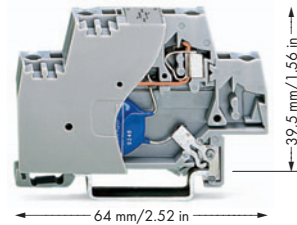

Description	V_N	Item No.	Pack. Unit	V_N	Item No.	Pack. Unit
Terminal block with surge suppression device and direct connection to DIN 35 rail	24 V DC	280-502/281-582	25	24 V DC	280-502/281-589	25
	48 V DC	280-502/281-583	25	48 V DC	280-502/281-590	25
	60 V DC	280-502/281-584	25	60 V DC	280-502/281-591	25
	115 V DC	280-502/281-585	25	115 V DC	280-502/281-592	25
	24 V AC	280-502/281-586	25	24 V AC	280-502/281-593	25
	110/120 V AC	280-502/281-587	25	110/120 V AC	280-502/281-594	25
	230 V AC	280-502/281-588	25	230 V AC	280-502/281-595	25

Technical Data	V_N	Max. Operating Voltage $V_{8 \text{ max.}}$	Nominal Discharge Current I_{SN}	Max. Surge Current $I_{S \text{ max.}}$	Capacity	Protection Level
Terminal blocks with varistor and end plate	24 V DC	31 V DC	300 A	1 kA	≤ 4.6 nF	77 V DC
	48 V DC	56 V DC	300 A	1 kA	≤ 2.8 nF	135 V DC
	60 V DC	85 V DC	1 kA	4.5 kA	≤ 1.7 nF	165 V DC
	115 V DC	150 V DC	1 kA	4.5 kA	≤ 0.8 nF	300 V DC
	24 V AC	30 V AC	300 A	1 kA	≤ 3.5 nF	93 V AC
	110/120 V AC	150 V AC	1 kA	4.5 kA	≤ 0.57 nF	360 V AC
	230 V AC	275 V AC	1 kA	4.5 kA	≤ 0.32 nF	710 V AC
Terminal blocks with varistor and end plate	24 V DC	28 V DC	305 A		≤ 2.7 nF	59 V DC
	48 V DC	53 V DC	162 A		≤ 1.7 nF	111 V DC
	60 V DC	70 V DC	123 A		≤ 1.35 nF	146 V DC
	115 V DC	128 V DC	68 A		≤ 0.85 nF	265 V DC
	24 V AC	26 V AC	258 A		≤ 2.4 nF	70 V AC
	110/120 V AC	133 V AC	46 A		≤ 0.63 nF	388 V AC
	230 V AC	253 V AC	37 A		≤ 0.4 nF	706 V AC

Technical Data		
Wire connection	CAGE CLAMP®	
Cross sections	0.08 mm ² ... 2.5 mm ² / AWG 28 ... 14	
Stripped lengths	8 ... 9 mm / 0.33 in	

	With gas filled surge arrester V_{BN} AC 24 V ... 230 V; I_{SN} 5 kA Rated current 20 A Terminal block width 10 mm/0.394 in	With gas filled surge arrester V_{BN} AC 24 V ... 230 V; I_{SN} 5 kA Rated current 20 A Terminal block width 10 mm/0.394 in
--	--	--

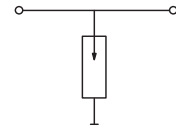
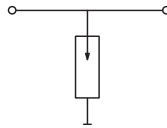
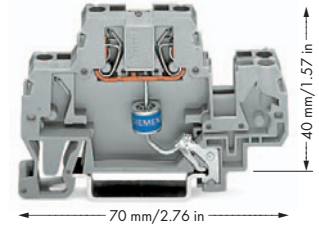
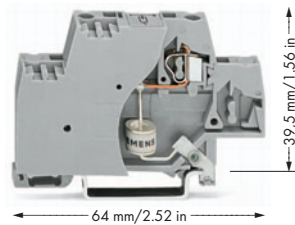

Description	V_N	Item No.	Pack. Unit	V_N	Item No.	Pack. Unit
Terminal block with surge suppression device and direct connection to DIN 35 rail	24 V AC/DC	280-503/281-579	25	24 V AC/DC	870-523/281-579	25
	110/120 V AC/DC	280-503/281-580	25	110/120 V AC/DC	870-523/281-580	25
	230 V AC/DC	280-503/281-581	25	230 V AC/DC	870-523/281-581	25

Technical Data

Max. operating voltage $V_{B \max}$	70 V AC/90 V DC 180 V AC/230 V DC 450 V AC/600 V DC	70 V AC/90 V DC 180 V AC/230 V DC 450 V AC/600 V DC
Nominal discharge current I_{SN}	5 kA	5 kA
Capacity	≤ 2 pF	≤ 2 pF
Protection level	600 V AC 650 V AC 1100 V AC	600 V AC 650 V AC 1100 V AC
Wire connection	CAGE CLAMP®	CAGE CLAMP®
Cross sections	0.08 mm ² ... 2.5 mm ² / AWG 28 ... 14	0.08 mm ² ... 2.5 mm ² / 4 mm ² "P" / AWG 28 ... 14
Stripped lengths	8 ... 9 mm / 0.33 in	6 ... 7 mm / 0.26 in

Accessories

	Item No.	Pack. Unit
 End and Intermediate Plate, 2 mm/0.079 in thick	gray	870-518 100 (4*25)
	orange	870-519 100 (4*25)

	<p>With varistor V_{BN} AC/DC 24 V ... AC 230 V; I_{SN} 300 A ... 1 kA Rated current 20 A</p> <p>Terminal block width 10 mm/0.394 in</p>	<p>With suppressor diode V_{BN} AC/DC 24 V ... AC 230 V; I_{SN} 37 A ... 305 A Rated current 20 A</p> <p>Terminal block width 10 mm/0.394 in</p>
--	--	--

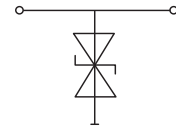
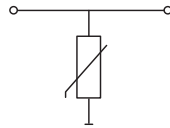
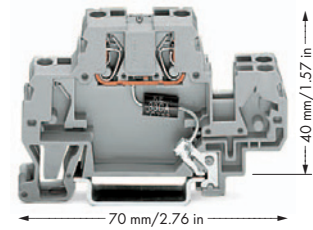
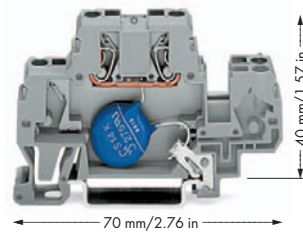

Description	V_N	Item No.	Pack. Unit	V_N	Item No.	Pack. Unit
Terminal block with surge suppression device and direct connection to DIN 35 rail	24 V DC	870-523/281-582	25	24 V DC	870-523/281-589	25
	48 V DC	870-523/281-583	25	48 V DC	870-523/281-590	25
	60 V DC	870-523/281-584	25	60 V DC	870-523/281-591	25
	115 V DC	870-523/281-585	25	115 V DC	870-523/281-592	25
	24 V AC	870-523/281-586	25	24 V AC	870-523/281-593	25
	110/120 V AC	870-523/281-587	25	110/120 V AC	870-523/281-594	25
	230 V AC	870-523/281-588	25	230 V AC	870-523/281-595	25

Technical Data	V_N	Max. Operating Voltage $V_{8 \text{ max.}}$	Nominal Discharge Current I_{SN}	Max. Surge Current $I_{S \text{ max.}}$	Capacity	Protection Level
Terminal block with varistor	24 V DC	31 V DC	300 A	1 kA	≤ 4.6 nF	77 V DC
	48 V DC	56 V DC	300 A	1 kA	≤ 2.8 nF	135 V DC
	60 V DC	85 V DC	1 kA	4.5 kA	≤ 1.7 nF	165 V DC
	115 V DC	150 V DC	1 kA	4.5 kA	≤ 0.8 nF	300 V DC
	24 V AC	30 V AC	300 A	1 kA	≤ 3.5 nF	93 V AC
	110/120 V AC	150 V AC	1 kA	4.5 kA	≤ 0.57 nF	360 V AC
	230 V AC	275 V AC	1 kA	4.5 kA	≤ 0.32 nF	710 V AC
Terminal block with suppressor diode	24 V DC	28 V DC	169 A		≤ 2.7 nF	59 V DC
	48 V DC	53 V DC	90 A		≤ 1.7 nF	111 V DC
	60 V DC	70 V DC	69 A		≤ 1.35 nF	146 V DC
	115 V DC	128 V DC	68 A		≤ 0.85 nF	265 V DC
	24 V AC	26 V AC	258 A		≤ 2.4 nF	70 V AC
	110/120 V AC	133 V AC	46 A		≤ 0.63 nF	388 V AC
	230 V AC	253 V AC	37 A		≤ 0.4 nF	706 V AC

Technical Data		
Wire connection	CAGE CLAMP®	
Cross sections	0.08 mm ² ... 2.5 mm ² / 4 mm ² "P" / AWG 28 ... 14	0.08 mm ² ... 2.5 mm ² / 4 mm ² "P" / AWG 28 ... 14
Stripped lengths	6 ... 7 mm / 0.26 in	6 ... 7 mm / 0.26 in

5 Pluggable Modules - Surge Suppression Devices

280

	<p>Three-stage suppression for 2-wire data, measuring and control circuits 24 V DC</p> <p>Module width 20 mm / 0.787 in</p>	<p>Three-stage suppression for 3-wire data, measuring and control circuits 12 V DC</p> <p>Module width 20 mm / 0.787 in</p>
--	---	---

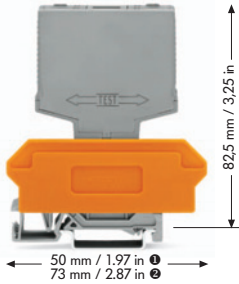

Note:
For isolation measurements the ground (earth) contact at the transient suppression module must be disconnected.

WSB marker card

- Marking F; Item No.: 209-791
- Marking 1 ... 10; Item No.: 209-702
- Marking +/-; Item No.: 209-652
- Marking Lin, PE, PE, N, Lout, PE, PE, N; Item No.: 249-652

5 cards, each containing 10 strips with 10 markers

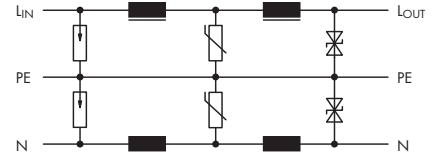
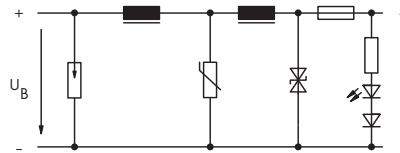

Description	U_{BN}	Item No.	Pack. Unit	U_{BN}	Item No.	Pack. Unit
Surge suppression module	24 V DC	286-833	1	12 V DC	286-834	1

Technical Data

Accessories see pages 138 ... 139

Accessories see pages 138 ... 139

Nominal operating voltage V_{BN}	24 V DC	12 V DC
Operating voltage	30 V DC	14 V DC
Nominal current	0.1 A	6 A
Nominal discharge current between L/N and PE	5 kA	1.5 kA
Nominal discharge current between L and N	5 kA	1.5 kA
Max. surge current between L/N and PE	5 kA	1.5 kA
Max. surge current between L and N	5 kA	1.5 kA
Protection level between L/N and PE	≤ 59 V	≤ 22 V
Protection level between L and N	≤ 59 V	≤ 22 V
Response time between L/N and PE	≤ 10 ns	≤ 10 ns
Response time between L and N	≤ 10 ns	≤ 10 ns
Through resistance / inductivity	20 m Ω / 2 x 7 μ H	50 m Ω / 14 μ H
Ambient operating temperature	-25 °C ... +85 °C	-25 °C ... +85 °C

Accessories	Item No.	Pack. Unit	Item No.	Pack. Unit
Terminal block for pluggable modules, with 2-conductor terminal blocks, orange separator ①	22 mm / 0.866 in 280-638	1	22 mm / 0.866 in 280-638	1
with 4-conductor terminal blocks, orange separator	22 mm / 0.866 in 280-628	1	22 mm / 0.866 in 280-628	1
with 4-conductor terminal blocks, marker plate ②	25 mm / 0.984 in 280-764	1	25 mm / 0.984 in 280-764	1
wire range 0.08 mm ² ... 2.5 mm ² / AWG 28 ... 14; stripped length 8 ... 9 mm / 0.33 in				

	<p>Three-stage suppression for 3-wire data, measuring and control circuits 24 V DC</p> <p>Module width 20 mm / 0.787 in</p>	<p>Two-stage suppression for 3-wire control, signal or power circuits 24 V AC/DC</p> <p>Module width 20 mm / 0.787 in</p>
--	---	---

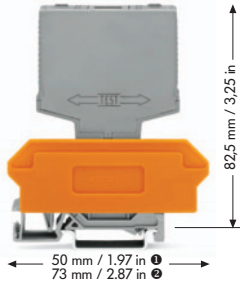

Note:

For isolation measurements the ground (earth) contact at the transient suppression module must be disconnected.

WSB marker card

- Marking F; Item No.: 209-791
- Marking 1 ... 10; Item No.: 209-702
- Marking Lin, PE, PE, N, Lout, PE, PE, N; Item No.: 249-652
- Marking PE, N, Lin, PE, N, Lout; Item No.: 209-911

5 cards, each containing 10 strips with 10 markers

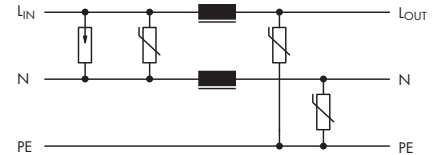
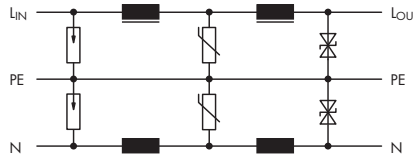

Description	U _{BN}	Item No.	Pack. Unit	U _{BN}	Item No.	Pack. Unit
Surge suppression module	24 V DC	286-834/024-000	1	24 V AC/DC	286-831	1

Technical Data

Accessories see pages 138 ... 139

Accessories see pages 138 ... 139

Nominal operating voltage V _{BN}	24 V DC	24 V AC/DC
Operating voltage	30 V DC	30 V AC / 38 V DC
Nominal current	6 A	6 A
Nominal discharge current between L/N and PE	1.5 kA	200 A
Nominal discharge current between L and N	1.5 kA	1.5 kA
Max. surge current between L/N and PE	1.5 kA	500 A
Max. surge current between L and N	1.5 kA	1.5 kA
Protection level between L/N and PE	≤ 59 V	≤ 93 V
Protection level between L and N	≤ 59 V	≤ 93 V
Response time between L/N and PE	≤ 10 ns	≤ 25 ns
Response time between L and N	≤ 10 ns	≤ 25 ns
Through resistance / inductivity	50 mΩ / 14 μH	25 mΩ / 2 x 7 μH
Nominal voltage acc. to VDE 0110 Part 1/4.97, IEC 60664-1	24 V DC	250 V / 4 kV / 3
Ambient operating temperature	-25 °C ... +85 °C	-25 °C ... +85 °C

Accessories

Accessories	Item No.	Pack. Unit	Item No.	Pack. Unit
Terminal block for pluggable modules, with 2-conductor terminal blocks, orange separator ①	22 mm / 0.866 in 280-638	1	22 mm / 0.866 in 280-638	1
with 4-conductor terminal blocks, orange separator	22 mm / 0.866 in 280-628	1	22 mm / 0.866 in 280-628	1
with 4-conductor terminal blocks, marker plate ②	25 mm / 0.984 in 280-764	1	25 mm / 0.984 in 280-764	1
wire range 0.08 mm ² ... 2.5 mm ² / AWG 28 ... 14; stripped length 8 ... 9 mm / 0.33 in				

5 Pluggable Modules - Surge Suppression Devices

	<p>Two-stage suppression for 3-wire control, signal or power circuits 24 V AC/DC</p> <p>Module width 20 mm / 0.787 in</p>	<p>Two-stage suppression for 3-wire control, signal or power circuits with filter 115 V DC, 230 V DC, 110 V / 120 V AC, 230 V AC/DC</p> <p>Module width 25 mm / 0.984 in</p>
--	---	--

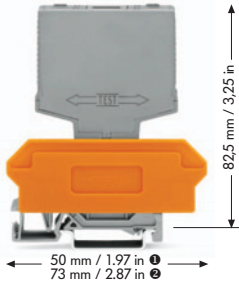

Note:

For isolation measurements the ground (earth) contact at the transient suppression module must be disconnected.

WSB marker card

- Marking F; Item No.: 209-791
- Marking 1 ... 10; Item No.: 209-702
- Marking PE, N, Lin, PE, N, Lout; Item No.: 209-911

5 cards, each containing 10 strips with 10 markers

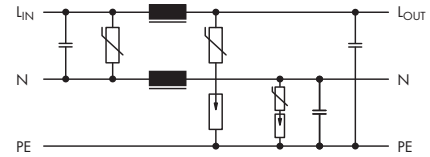
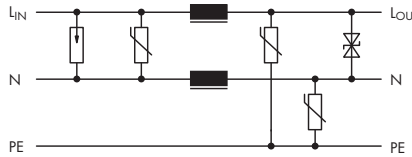

Description	U _{BN}	Item No.	Pack. Unit	U _{BN}	Item No.	Pack. Unit
Surge suppression module	24 V AC/DC	286-832	1	115 V DC	286-844	1
				110 V/120 V AC	286-843	1
				230 V DC	286-841	1
				230 V AC	286-842	1

Technical Data	Accessories see pages 138 ... 139	
Nominal operating voltage V _{BN}	24 V AC/DC	115 V DC; 110 V/120 V AC 230 V DC; 230 V AC
Operating voltage	AC 30 V / 38 V DC	180 V DC; 140 V AC 320 V DC; 250 V AC
Nominal current	6 A	6 A
Nominal discharge current between L/N and PE	200 A	600 A
Nominal discharge current between L and N	1.5 kA	600 A
Max. surge current between L/N and PE	500 A	1.5 kA
Max. surge current between L and N	1.5 kA	1.5 kA
Protection level between L/N and PE	≤ 93 V	≤ 900 V
Protection level between L and N	≤ 59 V	≤ 650 V
Response time between L/N and PE	≤ 25 ns	≤ 1 μs
Response time between L and N	≤ 5 ns	≤ 25 ns
Through resistance / inductivity	25 mΩ / 2 x 7 μH	- / 2 x 0.8 mH
Nominal voltage acc. to VDE 0110 Part 1/4.97, IEC 60664-1	250 V / 4 kV / 3	250 V / 4 kV / 3
Ambient operating temperature	-25 °C ... +85 °C	-25 °C ... +85 °C
Insertion loss		20 dB ... 40 dB / 0.15 MHz ... 30 MHz

Accessories	Item No.	Pack. Unit	Item No.	Pack. Unit
Terminal block for pluggable modules, with 2-conductor terminal blocks, orange separator ①	22 mm / 0.866 in 280-638	1	27 mm / 1.063 in 280-639	1
with 4-conductor terminal blocks, orange separator	22 mm / 0.866 in 280-628	1	27 mm / 1.063 in 280-629	1
with 4-conductor terminal blocks, marker plate ②	25 mm / 0.984 in 280-764	1	30 mm / 1.181 in 280-765	1
wire range 0.08 mm ² ... 2.5 mm ² / AWG 28 ... 14; stripped length 8 ... 9 mm / 0.33 in				



WAGO Application: Plastic Technology Center (SKZ) in Würzburg, Germany

WAGO Products:
WAGO-I/O-SYSTEM with ETHERNET
Controllers, DALI and EnOcean Components

6



789 Series

EnOcean Radio Receivers in DIN-Rail-Mount Enclosure

288



770 Series

WINSTA® - Radio Receiver

289



758 Series

Radio Receiver and Transmitter

290

WAGO Radio Receiver with EnOcean Technology

The Benefits for Electronic and Radio Technology

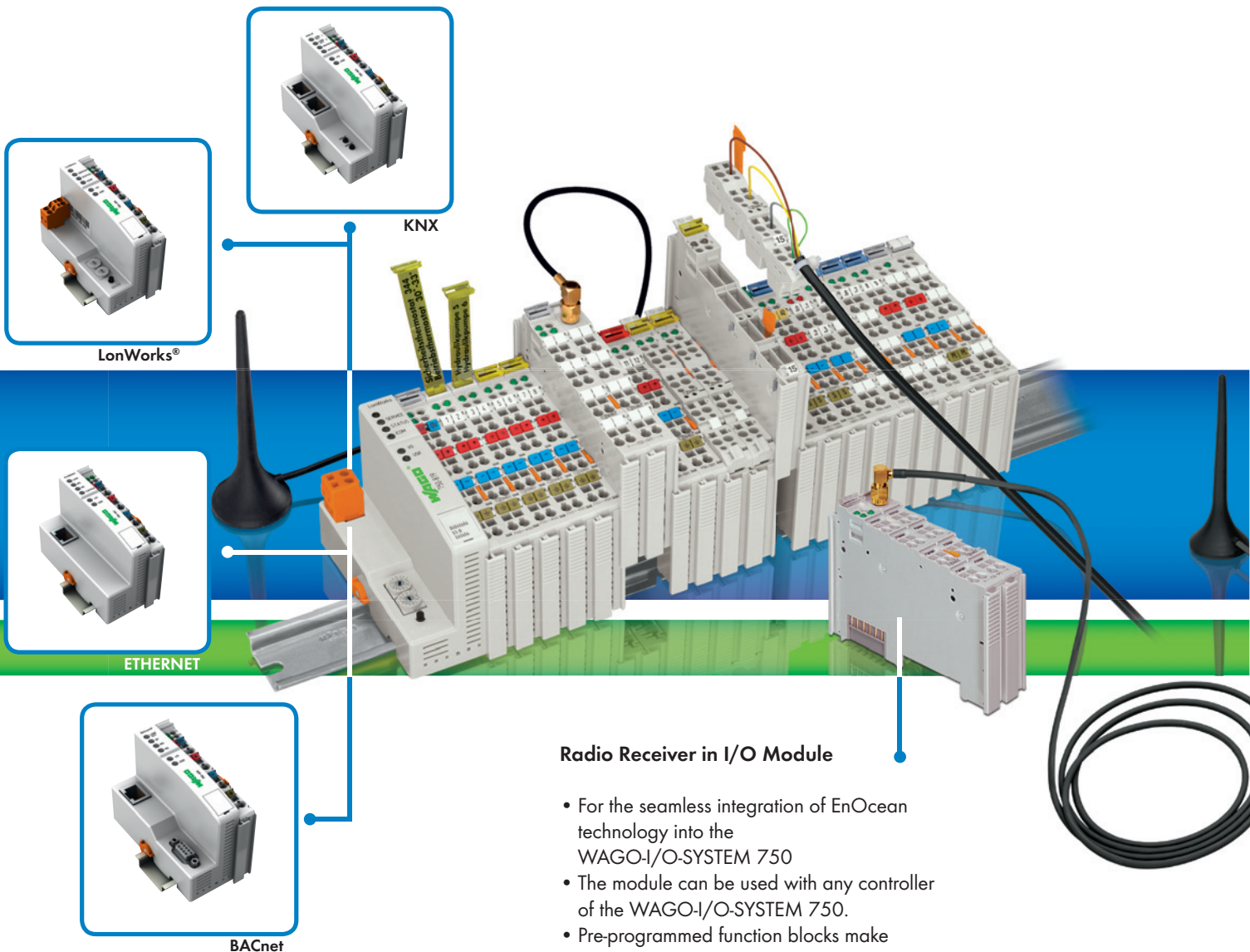
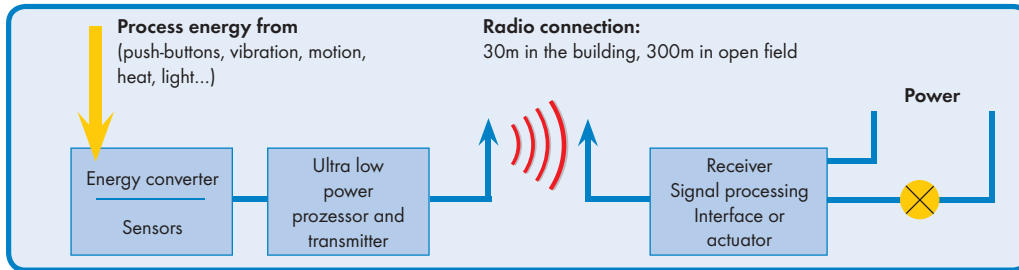

Radio Receiver in I/O Module

- For the seamless integration of EnOcean technology into the WAGO-I/O-SYSTEM 750
- The module can be used with any controller of the WAGO-I/O-SYSTEM 750.
- Pre-programmed function blocks make integration easy
- The number of sensors is almost unlimited

Item No. 750-642



enocean®

Radio Receiver in DIN-Rail Mount Enclosure

The stand-alone solution for DIN-rail mounting:
4-channel radio receiver module in 70mm
DIN-rail mount enclosure.

Version 1: 4 make contacts,
up to 16 A load carrying capacity
Version 2: 4 changeover contacts,
up to 8 A load carrying capacity per channel.

Item No. 789-601 (make contacts)
Item No. 789-602 (changeover contacts)

Radio Transmitter

Radio transmitter integrated in
universal switch insert.

Item No.
758-940/001-000 (2-channel light)
758-940/003-000 (4-channel light)
758-940/002-000 (2-channel roller blinds)
758-940/004-000 (4-channel roller blinds)

Radio Receiver in WINSTA® Box

All integrated: e.g. a complete blinds control (2-way
sunblind outputs for 230V/2A) or a 4-channel module
for lighting control (4-way switch output 230V/16A)
with receiver and all required switching relay.
The WINSTA® boxes are suitable for wall-, floor- and
ceiling-mounting.

Item No. 770-629/102-000 (sunblinds control)
Item No. 770-629/101-000 (lighting control)

External Antenna

The antenna fits to all WAGO
products shown here and is
connected using an SMA socket.
The antenna has a magnetic stand
and a 2.5m long coax cable.

Item No. 758-910

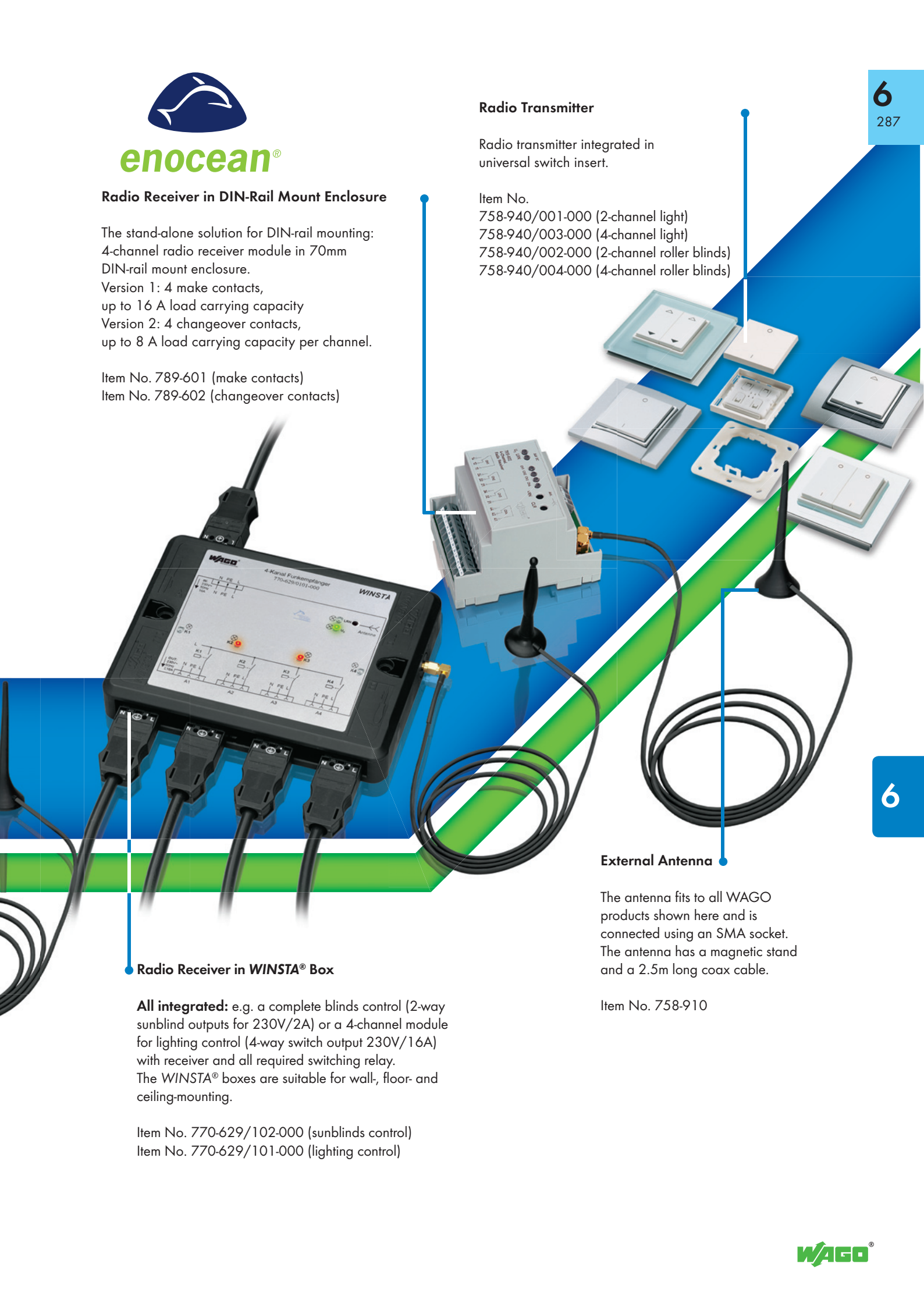

4-channel EnOcean radio receiver
with 4 make contacts, 16 A

4-channel EnOcean radio receiver
with 4 changeover contacts, 8 A

The 4-channel radio receiver in DIN-rail mount enclosure is used to switch 4 independent electrical devices or loads. The radio receiver processes telegrams transmitted by sensors (binary information) using EnOcean radio technology (PTM + STM modules). The outputs are switched via relay contacts.



- Radio receiver for battery-less and wireless sensors
- LED indication of switch status
- External antenna for optimum transmission range (required)
- Frequency band 868 MHz
- Transmitter-to-receiver assignment via learn mode

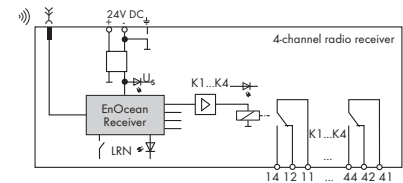
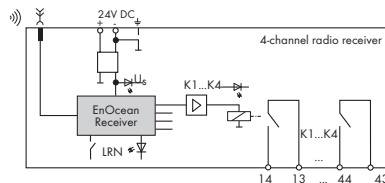

Description	Item No.	Pack. unit	Item No.	Pack. unit
4-channel EnOcean radio receiver	789-601	1	789-602	1
Technical Data				
Voltage supply	24 V DC		24 V DC	
Voltage range	-15 % ... + 20 %		-15 % ... + 20 %	
Current consumption (internal)	max. 90 mA		max. 90 mA	
Number of receive channels	40 (10 per output)		40 (10 per output)	
Number of channels	4 (relay outputs)		4 (relay outputs)	
Output current (per channel)	max. 16 A, AC1		max. 8 A, AC1	
Type of load	resistive / lamp load		resistive / motor load	
Switching frequency	max. < 5 Hz		max. < 5 Hz	
Delay time transmitter /output command	< 100 ms; 40 ms ... 70 ms typ.		< 100 ms; 40 ms ... 70 ms typ.	
Switching voltage	230 V AC		230 V AC	
Fuse protection	Loads: wire breaker, max. 16 A		Loads: wire breaker, max. 16 A	
Isolation	potential free contacts		potential free contacts	
Ambient operating temperature	0 °C ... +55 °C		0 °C ... +55 °C	
Storage temperature	-25 °C ... +85 °C		-25 °C ... +85 °C	
Relative air humidity (no condensation)	85 %		85 %	
Degree of pollution	2		2	
Degree of protection	IP20		IP20	
Mounting position	any		any	
Dimensions (mm) W x H x L	70 x 55 x 90		70 x 55 x 90	
Wire connection	Height from upper-edge of DIN 35 rail CAGE CLAMP® (WAGO 236 Series)		Height from upper-edge of DIN 35 rail CAGE CLAMP® (WAGO 236 Series)	
Cross sections	0.08 mm² ... 2.5 mm² / AWG 28 ... 12 (THHN, THWN)		0.08 mm² ... 2.5 mm² / AWG 28 ... 12 (THHN, THWN)	
Stripped lengths	5 ... 6 mm / 0.22 in		5 ... 6 mm / 0.22 in	
Approvals	Vibration and shock resistance acc. to IEC 60068-2-6 and IEC 60068-2-27		Vibration and shock resistance acc. to IEC 60068-2-6 and IEC 60068-2-27	
Accessories: RF magnetic antenna incl. 3m connecting cable with SMA connector	758-910		758-910	

	4-channel radio receiver with 4 make contacts	2-channel radio receiver with sunblind outputs
--	--	---

The 4-channel radio receiver is used to switch 4 independent electrical devices. The 2-channel radio receiver has 2 sunblind outputs that can be controlled independently from each other. The radio receiver processes telegrams transmitted by switches using EnOcean radio technology (STM modules). The outputs are switched via relay contacts.

- Radio receiver for battery-less and wireless sensors
- LED indication of switch status
- External antenna for optimum transmission range (required)
- Frequency band 868 MHz
- Transmitter-to-receiver assignment via learn mode
- The state of outputs can be predefined for a power failure scenario
- Wire connection using WINSTA connectors

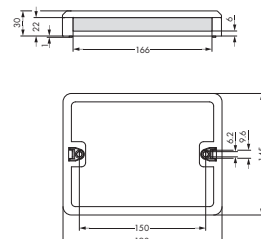
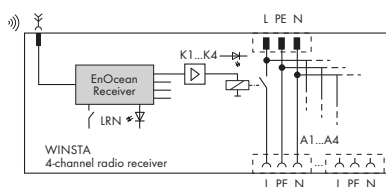

Illustration and block diagram for 770-629/101-000



Description	Item No.	Pack. unit	Item No.	Pack. unit
WINSTA® radio receiver	770-629/101-000	1	770-629/102-000	1

Technical Data

	770-629/101-000	770-629/102-000
Voltage supply	230 V AC, 50 Hz ... 60 Hz, max. 16 A	230 V AC, 50 Hz ... 60 Hz, max. 16 A
Voltage range	± 10 %	± 10 %
Current consumption (internal)	max. 21 mA	max. 21 mA
Number of channels	4	2
Output current (per channel)	max. 16 A / 4 A	2 A motor load
Total current	max. 16 A	max. 4 A
Inrush current	max. 120 A / 50 ms	25 A
Type of load	resistive / lamp load	resistive / inductive
Switching frequency	max. 5 Hz	max. 5 Hz
Isolation	isolated internal voltage supply 2500 V impulse withstand voltage	isolated internal voltage supply 2500 V impulse withstand voltage
Fuse protection	External, 16 A max.	External, 16 A max.
Ambient operating temperature	0 °C ... +55 °C	0 °C ... +55 °C
Storage temperature	-25 °C ... +85 °C	-25 °C ... +85 °C
Relative air humidity (no condensation)	85 %	85 %
Degree of pollution	2	2
Degree of protection	IP20	IP20
Mounting position	any	any
Dimensions (mm) W x H x L	195 x 145 x 30	195 x 145 x 30
Type of mounting	Wall screw fixing	Wall screw fixing
Approvals	Vibration and shock resistance acc. to IEC 60068-2-6 and IEC 60068-2-27	Vibration and shock resistance acc. to IEC 60068-2-6 and IEC 60068-2-27
Accessories: RF magnetic antenna incl. 3m connecting cable with SMA connector	758-910	758-910
Connection accessories WINSTA connectors	Input: socket, 3 poles, e.g. 770-103; 4-channel output: plug, 3 poles, e.g. 770-113	Input: socket, 3 poles, e.g. 770-103; 2-channel output: plug, 4 poles, e.g. 770-114

External antenna, GSM
900/1800



Description	Technical Data	Item No.	Pack. unit
External antenna	Frequency band: 870 MHz ... 960 MHz; 1710 MHz ... 1880 MHz VSWR: 870 MHz ... 960 MHz < 1.5; 1710 MHz ... 1880 MHz < 1.5 Gain: 870 MHz ... 960 MHz 0 dB; 1710 MHz ... 1880 MHz 0 dB Max. Power: 20 W Cable length: 250 cm Connector: SMA right angle plug + ferrite bead	758-910	1

Notes on operating the antenna with WAGO EnOcean radio receivers: The antenna is to be mounted on a plate measuring at least 9.8 x 9.8 inches (25 x 25 mm) The distance of interfering sources to the antenna and antenna line must be at least 11.8 inches (30 mm) and the free space between the antenna and the next wall must be at least 13.78 inches (35 mm). The antenna cable should, under no circumstances, be bent sharply, since irreversible damage may result to the antenna (RG 174 bend radius > 0.6 inches/15mm)

Radio transmitter,
EnOcean easyfit PTM
250

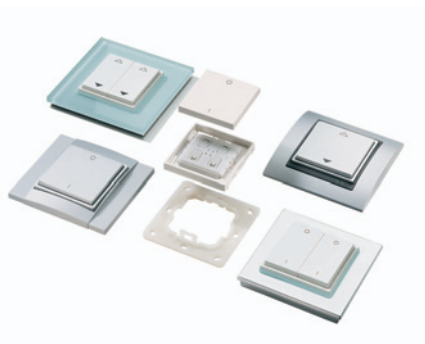

Description	Technical Data	Item No.	Pack. unit
2-channel light	Integrated radio transmitter: EnOcean PTM 200 Energy harvesting source: electrodynamic energy	758-940/001-000	1
4-channel light	generator, maintenance free Radio technology /range: EnOcean 868 MHz, RPS Type 2; 300 m free	758-940/003-000	1
2-channel roller blind	field, typ. 30 m within buildings Total installation height: 14 mm (frame lies directly against the wall)	758-940/002-000	10
4-channel roller blind	Dimensions of rocker /frame cut-out /central plate: 50 x 50 mm / 55 x 55 mm / 71 x 71 mm Color: white	758-940/004-000	1

The universal switch insert can be integrated into numerous control programmes by different manufacturers, e.g.: BERKER, GIRA, JUNG and MERTEN. Delivery is without frame. Frames of the desired control programm have been orderen separately.



WAGO Application: Bellinzona Business Center (Tessin), Switzerland

WAGO Products:
WAGO-I/O-SYSTEM with ETHERNET Controllers,
Power Supplies and Interface Modules

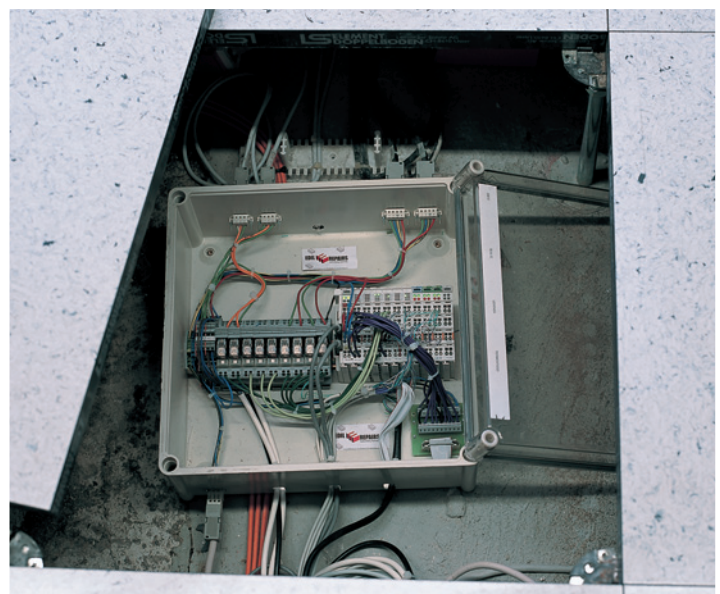



280, 286, 786 Series

Empty Component Plug Housings for Building Custom Circuits
Empty Component Plug Housings for Building Custom Circuits

294 - 295
296

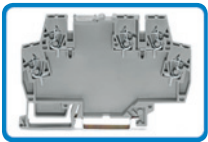

859 Series

Empty Electronic Terminal Block Housing

297

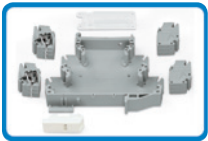

789 Series

DIN-Rail Mounted Enclosures
Accessories, 789 Series

298
299

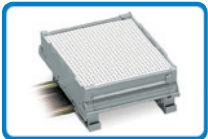

209, 210, 288 Series

Mounting Carrier for DIN-Rail Mounting PCBs
Mounting Carrier and Feet for DIN-Rail Mounting PCBs

300 - 301
302 - 303

Empty Component Plug Housings for Building Custom Circuits

286 Series, empty component plug



Description		Item No.	Pack. Unit
Empty component plug, type 9	4-pole, 10 mm / 0.394 in wide	286-110	1
Empty component plug, type 10	6-pole, 15 mm / 0.591 in wide	286-111	1
Empty component plug, type 11	8-pole, 20 mm / 0.787 in wide	286-112	1
Empty component plug, type 12	10-pole, 25 mm / 0.984 in wide	286-113	1

250 V/ 4 KV/ 3 (rated voltage/ rated surge voltage/ pollution degree);
 6 A per contact;
 Module height 82.5 mm/3.25 in (from upper-edge of DIN 35 rail);
 PCB dimensions and component height see drawing and table
PCB dimensions

Module width	10	15	20	25
Component height	4.2	9.2	14.2	19.2
X = total height of PCB	8	13	18	23

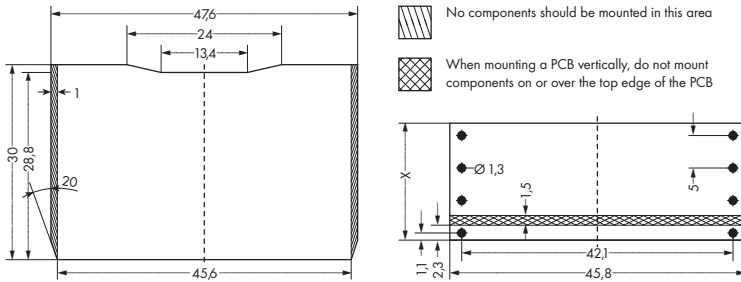

786 Series, empty component plug



Description		Item No.	Pack. Unit
Empty component plug, type 14	6-pole, 15 mm / 0.591 in wide	786-101	1
Empty component plug, type 15	8-pole, 20 mm / 0.787 in wide	786-102	1
Empty component plug, type 16	10-pole, 25 mm / 0.984 in wide	786-103	1

250 V/ 4 KV/ 3 (rated voltage/ rated surge voltage/ pollution degree);
 6 A per contact;
 Module height 82.5 mm/3.25 in (from upper-edge of DIN 35 rail);
 PCB dimensions and component height see drawing and table
PCB dimensions

Module width	15	20	25
Component height	9.2	14.2	19.2
X = total height of PCB	13	18	23

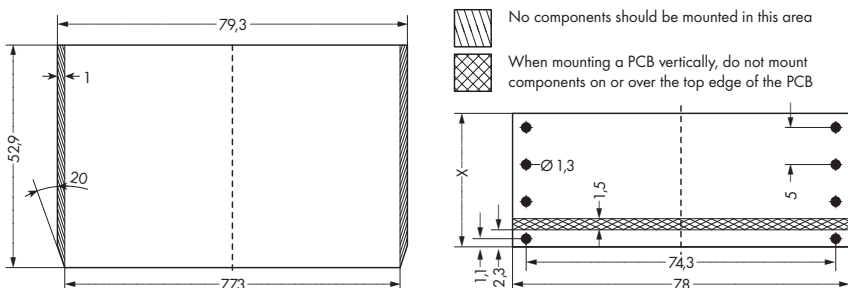

Unlocking pliers for component plug housing



WSB-marker cards



Description	Item No.	Pack. Unit
Unlocking pliers for component plug housing	210-492	1
WSB Quick marking system for module width 5 - 17.5 mm plain	209-501	5 cards
Marking 1 ... 10 (10 x)	209-702	5 cards
10 strips with 10 markers, white with black printing		

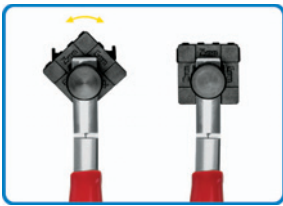

Adjust the pliers to the proper housing width

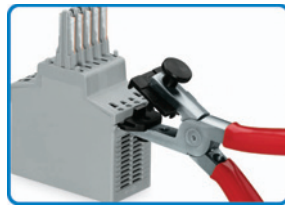

Insert the pliers into the locking slots . . .

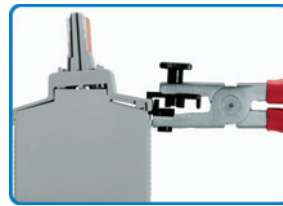

. . . by compressing the pliers . . .

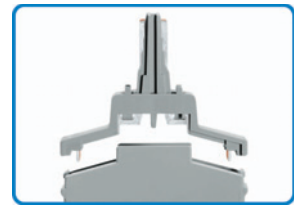

. . . the cover is removed.

2-conductor terminal block



4-conductor terminal block



Description	Item No.	Pack. Unit	
Terminal block for pluggable modules, with 2-conductor terminal blocks, orange separator	12 mm / 0.472 in wide	280-618	1
with 4-conductor terminal blocks, orange separator	12 mm / 0.472 in wide	280-608	1
Terminal block for pluggable modules, with 2-conductor terminal blocks, orange separator	17 mm / 0.669 in wide	280-619	1
with 4-conductor terminal blocks, orange separator	17 mm / 0.669 in wide	280-609	1
Terminal block for pluggable modules, with 2-conductor terminal blocks, orange separator	22 mm / 0.866 in wide	280-638	1
with 4-conductor terminal blocks, orange separator	22 mm / 0.866 in wide	280-628	1
Terminal block for pluggable modules, with 2-conductor terminal blocks, orange separator	27 mm / 1.063 in wide	280-639	1
with 4-conductor terminal blocks, orange separator	27 mm / 1.063 in wide	280-629	1

Wire range 0.08 mm² ... 2.5 mm² / AWG 28 ... 14; Stripped lengths 8 ... 9 mm / 0.33 in

Other Terminal blocks see Full Line Catalog, Volume 1, Rail-Mounted Terminal Block Systems

Empty Component Plug Housings for Building Custom Circuits

280 Series, empty component plug housings for building custom circuits



Description	Item No.	Pack. Unit
Empty component plug, type 1 2-pole, 5 mm / 0.197 in wide; Inside dimensions of plug W/H/D 3.2/15/15 mm (0.126/0.591/0.591 in)	280-801	100
Empty component plug, type 2 2-pole, 10 mm / 0.394 in wide; Inside dimensions of plug W/H/D 8.2/15/15 mm (0.323/0.591/0.591 in)	280-802	50
Empty component plug, type 3 4-pole, 10 mm / 0.394 in wide; Inside dimensions of plug W/H/D 8.2/15/15 mm (0.323/0.591/0.591 in)	280-804	50

250 V/ 4 KV/ 3 (rated voltage/ rated surge voltage/ pollution degree);

2-conductor terminal



3-conductor terminal

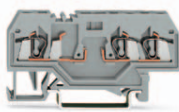

4-conductor terminal

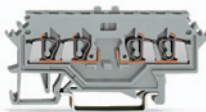

Description	Item No.	Pack. Unit
2-conductor terminal block gray, terminal block width 5 mm /0.197 in, marking on both sides	280-616	100
2-conductor terminal block gray, terminal block width 5 mm /0.197 in, marking in center position	280-916	100
3-conductor terminal block gray, terminal block width 5 mm /0.197 in	280-610	100
4-conductor terminal block gray, terminal block width 5 mm /0.197 in, marking on both sides	280-606	100
4-conductor terminal block gray, terminal block width 5 mm /0.197 in, marking in center position	280-686	100

Wire range 0.08 mm² ... 2.5 mm² / AWG 28 ... 14; Stripped lengths 8 ... 9 mm / 0.33 in
For accessories like end plates, jumpers etc. see Full Line Catalog, Volume 1, Rail-Mounted Terminal Block Systems

Empty Component Plug Housings for Building Custom Circuits, 280 Series



2-conductor terminal block



3-conductor terminal block

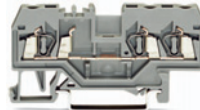

4-conductor terminal block

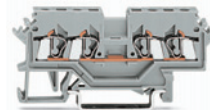

2-conductor terminal block



Description	Item No.	Pack. Unit
Empty component plug, type 4 2-pole, 10 mm / 0.394 in wide; Inside dimensions of plug W/H/D 8.2/15/15	280-803	50
250 V/ 4 KV/ 3 (rated voltage/ rated surge voltage/ pollution degree); 6 A max.		
Front-entry 2-conductor terminal block gray, terminal block width 5 mm /0.197 in, marking on both sides	280-601	100
Front-entry 2-conductor terminal block gray, terminal block width 5 mm /0.197 in, marking in center position	280-901	100
Front-entry 3-conductor terminal block gray, terminal block width 5 mm /0.197 in	280-681	100
Wire range 0.08 mm ² ... 2.5 mm ² / AWG 28 ... 12 (THHN, THWN); Stripped lengths 8 ... 9 mm / 0.33 in		
Front-entry 4-conductor terminal block gray, terminal block width 5 mm /0.197 in, marking on both sides	280-621	100
Front-entry 4-conductor terminal block gray, terminal block width 5 mm /0.197 in, marking in center position	280-833	100
Side-entry 2-conductor terminal block gray, terminal block width 5 mm /0.197 in	280-101	100
Wire range 0.08 mm ² ... 2.5 mm ² / AWG 28 ... 14; Stripped lengths 8 ... 9 mm / 0.33 in, For accessories like end plates, jumpers etc. see Full Line Catalog, Volume 1, Rail-Mounted Terminal Block Systems		

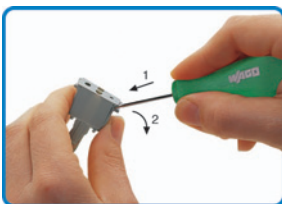

Press screwdriver into appropriate slot (1) and remove cover with levering action (2).



Introduce cover in the outer groove of the plug and press completely down until snap-fit engaged.

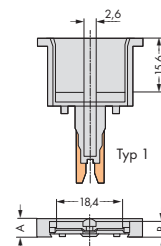
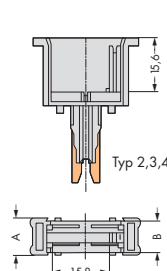

Typ	1	2	3	4
A	5	10	10	10
B	3,2	8,2	8,2	8,2

Empty Electronic Terminal Block Housing

859-110

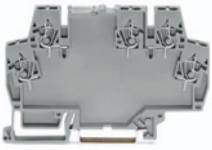

859-501

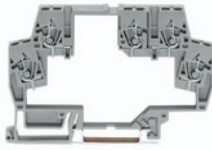

859-110 and 859-501

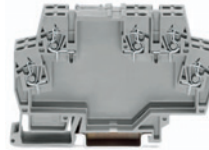

Description	Item No.	Pack. Unit	Technical Data
Modular housing for mounting electronic components in a rail-mounted terminal block	859-110	1	Housing material: PA 6.6
Frame to enlarge the terminal block width	859-501	1	Flammability rating: V0 Color: gray (similar to RAL 7038) Degree of protection: IP20 Perm. ambient temperature: -25 °C ... +70 °C Storage temperature: -40 °C ... +85 °C Width: 6 mm (859-110), 8 mm (859-501) Mounting position: any Dimensions (W x H x L): (6 x 56 x 91) mm Height from upper-edge of DIN 35 rail Wire connection: CAGE CLAMP® Cross sections: 0.08 mm ² ... 2.5 mm ² /AWG 28 ... 14 Stripped lengths: 5 ... 6 mm / 0.22 in

PCB dimensions

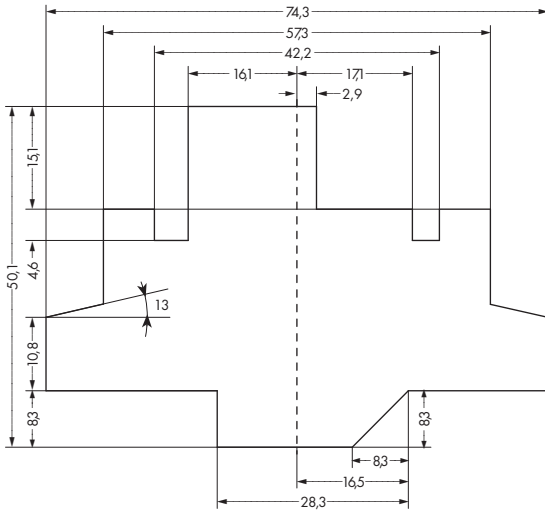

PCB dimensions

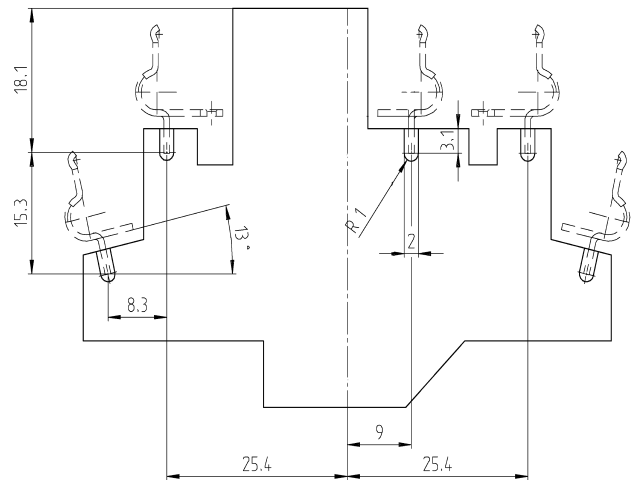

End and intermediate plate



Push-in type jumper bar



Commoning

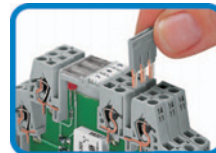

Test pin



Description		Item No.	Pack. Unit
End and intermediate plate; 1 mm / 0.039 in thick, gray		859-525	100 (4x25)
Push-in type jumper bars, light gray, insulated, 18 A	2-way	859-402	200 (8x25)
	3-way	859-403	200 (8x25)
	4-way	859-404	200 (8x25)
	5-way	859-405	200 (8x25)
	6-way	859-406	100 (4x25)
	7-way	859-407	100 (4x25)
	8-way	859-408	100 (4x25)
	9-way	859-409	100 (4x25)
	10-way	859-410	100 (4x25)
Item no. suffix for colored push-in type jumper bars	yellow	... /000-029	
	blue	... /000-006	
	red	... /000-005	
Test pin; Ø 1 mm / 0.039 in; test wire for sold. onto test plug		859-500	1 (1x1)

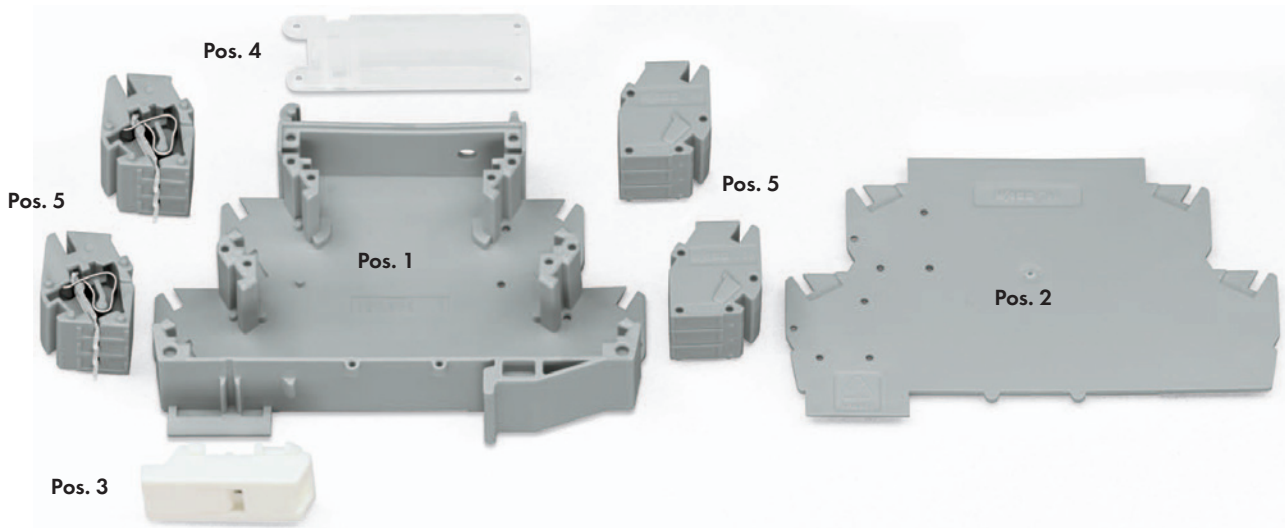

Description		Item No.	Pack. Unit	Technical Data
Housing 55 mm/2.17 in	Pos. 1	789-120	1	Rated voltage acc. to VDE 0110 Part 1 / 4.97 IEC 60664-1: 250 V / 4 kV / 3
Top cover 55 mm/2.17 in	Pos. 2	789-122	1	Housing material: PA 6.6
Transparent cover	Pos. 4	789-124	1	Flammability rating: V0
Release mechanism	Pos. 3	789-126	1	Color: gray (similar to RAL 7038)
3-pole terminal block: CCC*	Pos. 5	789-127	1	Degree of protection: IP20
3-pole terminal block: COC*	Pos. 5	789-128	1	Perm. ambient temperature: -25 °C ... +70 °C
3-pole terminal block: CCO*	Pos. 5	789-129	1	Storage temperature: -40 °C ... +85 °C
3-pole terminal block: OCC*	Pos. 5	789-130	1	Mounting position: any
3-pole terminal block: OCO*	Pos. 5	789-131	1	Dimensions (W x H x L): (17.5 x 55 x 90) mm Hight from upper-edge of DIN 35 rail
3-pole terminal block: OOO*	Pos. 5	789-132	1	Wire connection: CAGE CLAMP®
3-pole terminal block: OOC*	Pos. 5	789-133	1	Cross sections: 0.08 mm ² ... 2.5 mm ² / AWG 28 ... 14
3-pole terminal block: COO*	Pos. 5	789-134	1	Stripped lengths: 5 ... 6 mm / 0.22 in

* C = with clamping spring, O = without clamping spring, enclosure open on the right side

PCB dimensions, horizontal mounting

* less 4.5mm when mounting a vertical PCB on level 1

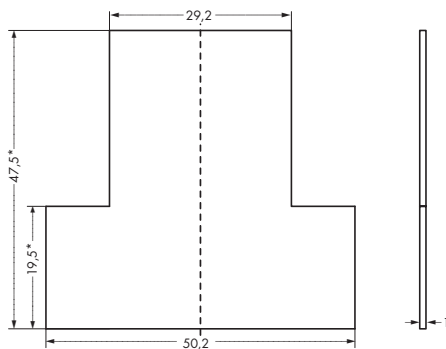

PCB dimensions vertical mounting (max. PCB thickness 1.5 mm) in level 1;

(max. PCB thickness 1 mm) in level 2 and 3

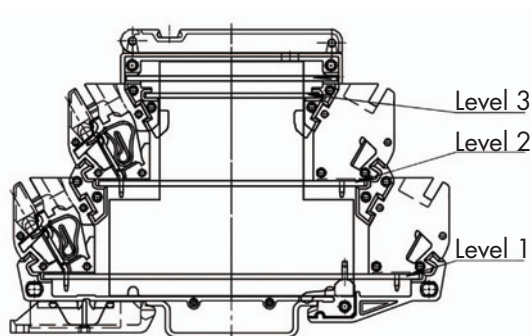
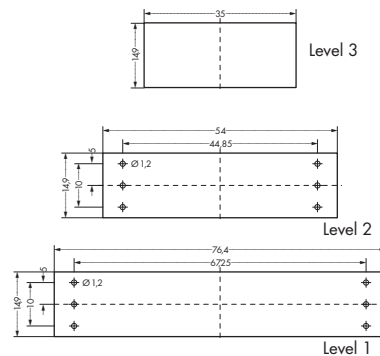

Push-in type jumper bars



Commoning



Description		Item No.	Pack. Unit
Push-in type jumper bars	uninsulated, 12-way, to be cut to the required length	789-112	100 (4x25)

Operating tool



Wire connection



Marking pen with fiber tip



Description		Item No.	Pack. Unit
Operating tool, with partially insulated shaft	Type 2, blade (3.5 x 0.5) mm	210-720	1
Marking pen	for permanent marking	210-110	1

Miniature quick marking card



Marking

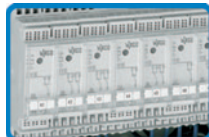

Description		Item No.	Pack. Unit
Miniature WSB Quick marking system	plain	248-501	5 cards
Marking software and printer/plotter see Section 8			
Marking	1 ... 10 (10 x)	248-502	5 cards
	11 ... 20 (10x)	248-503	5 cards
	21 ... 30 (10x)	248-504	5 cards
	31 ... 40 (10x)	248-505	5 cards
	41 ... 50 (10 x)	248-506	5 cards
	1 ... 50 (2 x)	248-566	5 cards
	K 1 ... K 10 (10 x)	248-450	5 cards
	K 11 ... K 20 (10 x)	248-451	5 cards
	K 100 (10 x)	248-452	5 cards
	U 1 ... U 10 (10 x)	248-453	5 cards
	U 11 ... U 20 (10 x)	248-454	5 cards
	U 100 (10 x)	248-455	5 cards
10 strips with 10 markers, white with black printing			

7 Mounting Carrier for DIN-Rail Mounting PCBs

300

Mounting carrier size 1

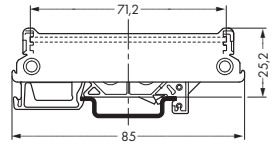
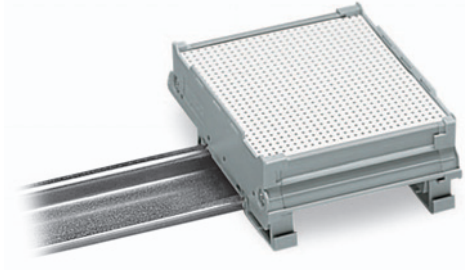

Description	Item No.	Pack. Unit
Lateral cover, size 1, small, 6.35 mm /0.25 in thick	288-601	1
Fixing foot for mounting on DIN 35 rails	288-602	1
Track section, size 1, 1 m /3'3" long	288-600	1

In order to determine the length of a complete mounting carrier:

Length of PCB: L1

Length of track section: L2 = L1 - 11 mm /0.433 in

Length of mounting carrier: L3 = L1 + 1.7 mm /0.067 in

with lateral cover size 1, 6.35 mm /0.25 in thick.

Distance between PCB and upper groove of track section is 5 mm /0.197 in PCB tolerances: thickness 1.5 mm ± 0.2 mm, length/width ± 0.2 mm; -0.1/+0.3 for milling contours

Marker strips



Description	Item No.	Pack. Unit
Phillips screw 2.9 x 13*	210-533	25
7.5x0.5mm on roll 5x1m, white	709-198	1
7.5x0.5mm on roll 5x1m, translucent	709-196	1

* To be used from a module length of 35 mm /1.378 in. For smaller modules the lateral covers have to be riveted. Rivet length depends on module length. Rivets not in the WAGO product range.

Mounting carrier size 1

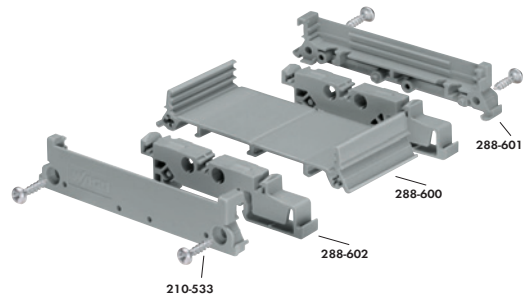

Mounting Carrier for DIN-Rail Mounting PCBs

Mounting carrier size 2

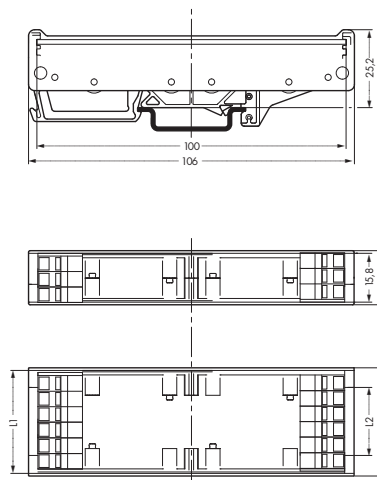
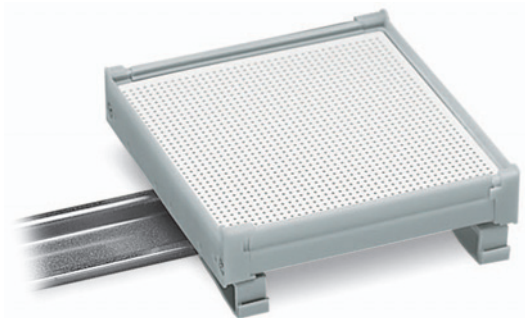

Description	Item No.	Pack. Unit
Lateral cover, size 2, small*, 8.75 mm /0.344 in thick	288-621	1
Fixing foot for mounting on DIN 35 rails	288-622	1
Track section, size 2, 1 m /3'3" long	288-620	1

Mounting carrier size 2, with covering section

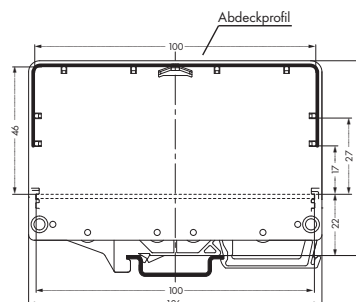

Description	Item No.	Pack. Unit
Lateral cover, size 2, big* 8.75 mm /0.344 in thick	288-626	1
Covering section, size 2, 1 m /3'3" long	288-627	1

In order to determine the length of a complete mounting carrier:

- Length of PCB: L1
- Length of track section: L2 = L1 - 15,8 mm/0.622 in
- Length of mounting carrier: L3 = L1 + 1.7 mm/0.067 in
- Length of covering section: L4 = L1
- with lateral cover, size 2, 8.75 mm/0.344 in thick
- Distance between PCB and upper groove of track section is 5 mm/0.197 in PCB tolerances: thickness 1.5 mm ± 0.2 mm, length/width ± 0.2 mm; -0.1/+0.3 for milling contours

Mounting carrier size 2

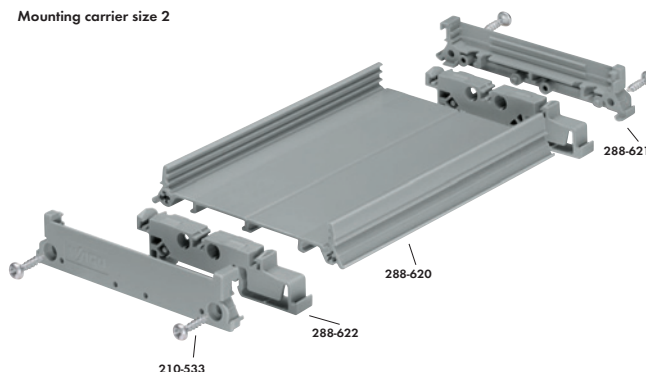

Mounting Carrier and Feet for DIN-Rail Mounting PCBs

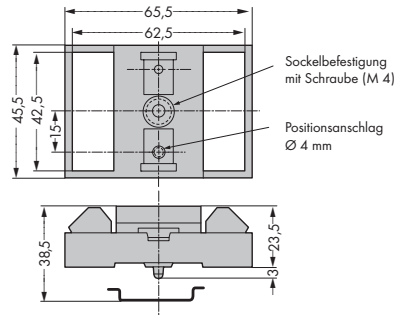
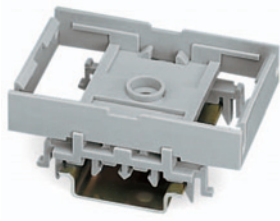

Description		Item No.	Pack. Unit
Mounting carrier	For screw-fixing or DIN-rail mounting with snap-fit type universal mounting feet (then needs 2 x mounting feet)	288-001	1
Universal mounting foot	Snap-fit type, suitable for DIN 15, 32 and 35 rails	288-002	10
Universal mounting foot	Suitable for Europa card (100 x 160) mm	288-003	1

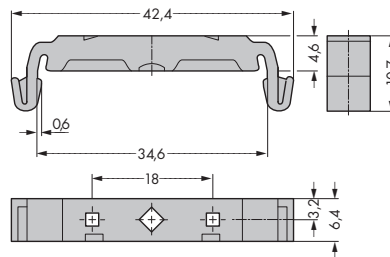

Description		Item No.	Pack. Unit
Mounting foot	For screw-fixing to relay modules, holes for fixing screws 2 mm/0.079 in, PCB hole $\varnothing 3.2$ mm/0.126 in, distance 18 mm/0.709 in,	209-120	25
Fixing screw	For mounting foot 209-120	209-119	50

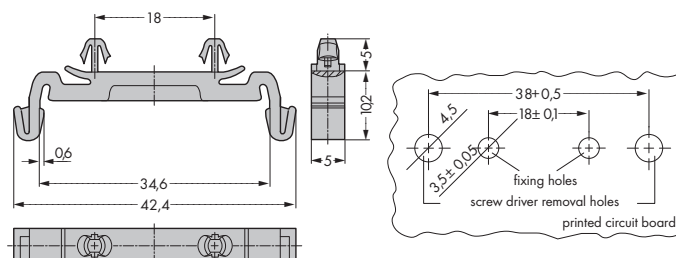

Description		Item No.	Pack. Unit
Mounting foot	For snap-fit mounting to relay modules, for fixing hole $\varnothing 3.5$ mm/0.138 in, distance 18 mm/0.709 in, for mounting on DIN 35 rail	209-188	25

**WAGO Application: Stockholm-Arlanda Airport,
Sweden**
Automated Passenger Boarding Bridges

WAGO Products:
WAGO I/O-SYSTEM with DeviceNet Couplers and
Rail-Mounted Terminal Blocks



8



790, 791 Series

Shield (Screen) Connecting System

306 - 309



ProServe

Designing, Assembling and Marking
Thermal Transfer Printers and Accessories
Engraving Plotters with Engraver and Accessories

310 - 315
316 - 319
320 - 322



Marking Accessories

WMB Multi Marking System, Miniature Quick Marking Card,
WMB Inline, Marker Cards and Group Marker Carriers

323



211 Series

WAGO Wire and Cable Marking

324 - 325



210, 249 Series

Carrier Rails
End Stop for DIN 35 Rails and Angled Support Bracket

326
327



206, 210 Series

Tools

328 - 331

Shield (Screen) Connecting System Description and Handling

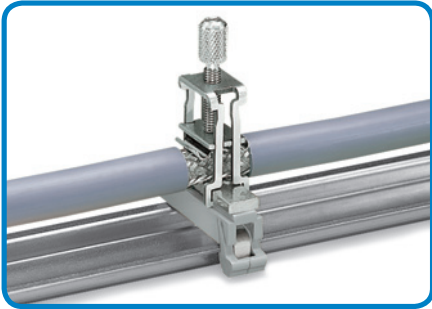

Carrier with grounding foot
45 mm/1.772 in long, busbar 90° to the rail
Item No. 790-113

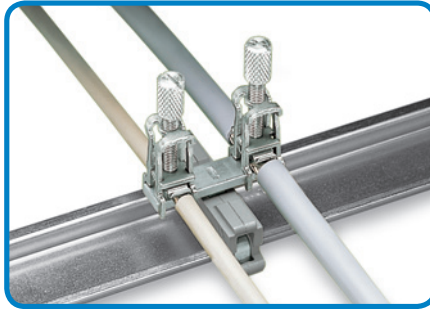

Carrier with grounding foot
45 mm/1.772 in long, busbar parallel to the rail
Item No. 790-114

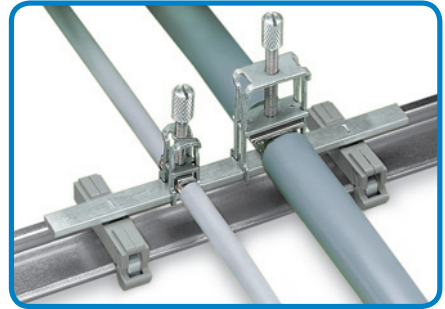

Carrier with 2 grounding feet
125 mm/4.921 in long, busbar parallel to the rail
Item No. 790-115

for all sizes of shield (screen) clamping saddles

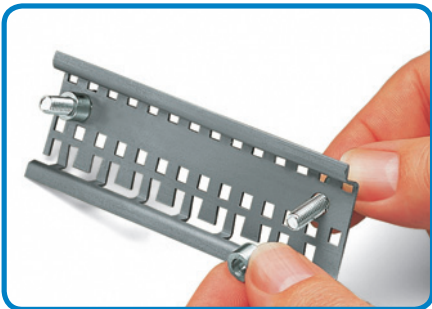

Using a stand off
with a special slotted carrier rail



Addition of a shield (screen) clamping saddle.

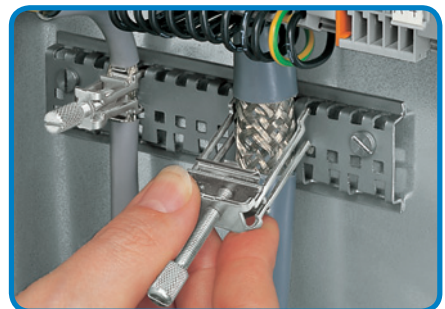
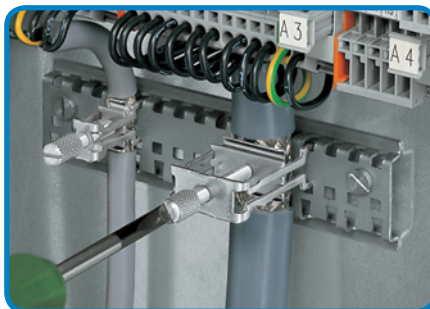
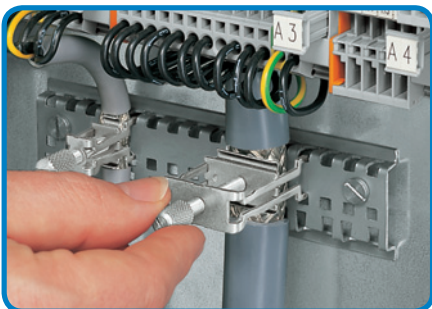
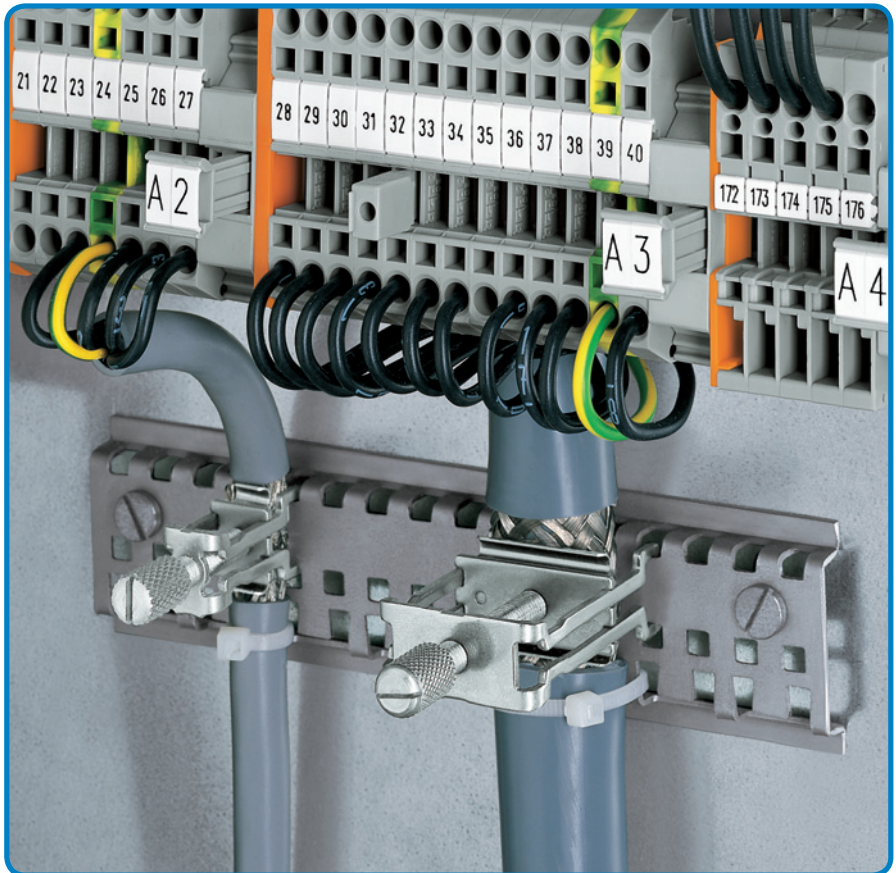

Tightening/releasing a shield (screen) clamping saddle. To attach the clamping saddle, tighten the knurled screw. To remove, unscrew until ratcheted mechanism is released, then slightly tip saddle and remove the clamping saddle.

Mounting Options Based on Application

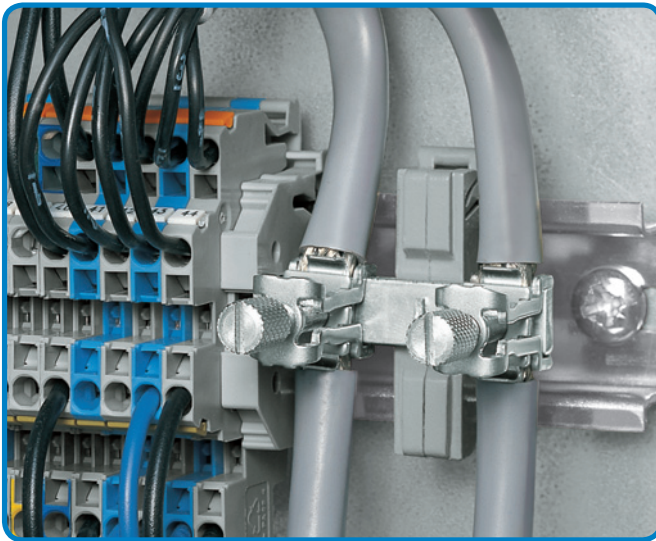

- carrier with grounding foot, busbar parallel to the rail

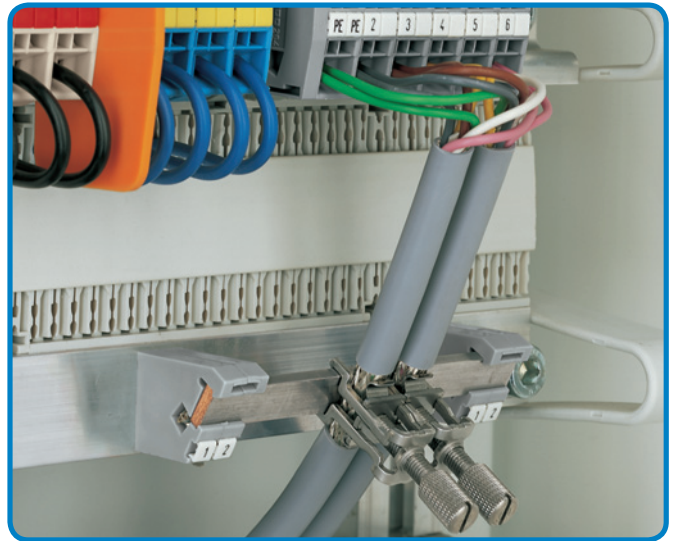

- isolated mounting carriers for a common shield (screen) reference potential, independent of the housing potential

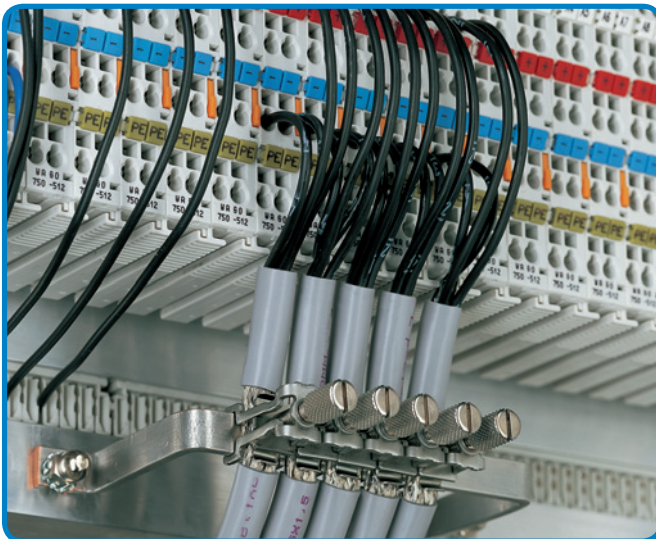

- U-shaped copper busbar 10 mm (0.394 in) x 3 mm (0.118 in)

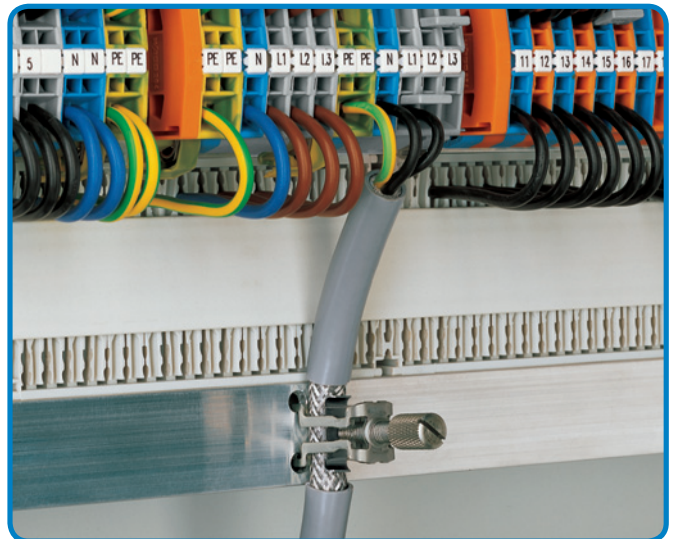

- snap into any metal plate up to max. thickness 3 mm/0.118 in

Negative shield (screen) attenuation

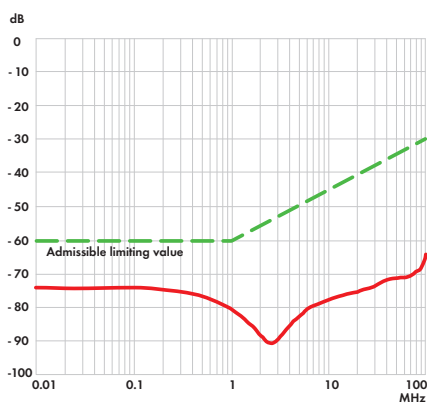

Shield (screen) clamping saddle size

Distance X	11 mm	9.5 mm
Distance Y	19 mm	17.5 mm
	27 mm	25.5 mm
	43 mm	41.5 mm

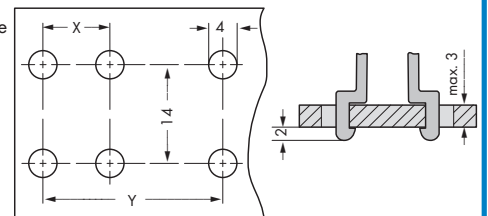

Hole dimensions for panel mounting

The WAGO shield (screen) connecting system is highly effective because the clamping unit can be brought very close to the unshielded part of the cable. Additionally, the spring material is part of the clamping saddle, giving good electrical connection and compensating for any deformation in the braiding. The system also acts as a partial strain relief.

Shield (screen) clamping saddles

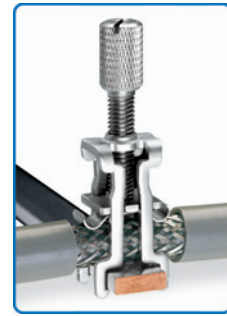

Description		Diameter of Connectable Conductor	Item No.	Pack. Unit
Shield (screen) clamping saddle, incl. knurled screw	11 mm/0.433 in wide	up to 8 mm/0.315 in	790-108	50 (5x10)
	19 mm/0.748 in wide	7 mm/0.276 in to 16 mm/0.63 in	790-116	50 (5x10)
	27 mm/1.063 in wide	6 mm/0.236 in to 24 mm/0.944 in	790-124	50 (5x10)
	43 mm/1.693 in wide	22 mm/0.866 in to 40 mm/1.575 in	790-140	50 (5x10)

Note: Not for ground connections! **Recommended tightening torque: 0.5 Nm** **Assembly:** The shield (screen) clamping saddle is shipped ready for direct connection to the busbar 10 mm (0.394 in) x 3 mm (0.118 in) or to a drilled mounting plate. After connection, tighten the knurled screw to complete the installation.

Removal: To remove a shield (screen) clamping saddle, unscrew until ratcheted mechanism is released, then slightly tip saddle and remove the clamping saddle.

Assembly



Removal

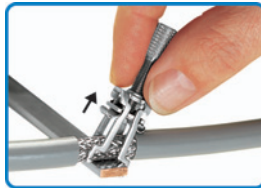

Installation position delivery

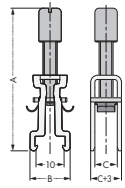

Closed position

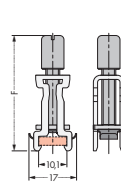

Removal position

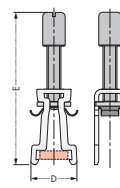

Item No.	Dimensions in mm					
	A	B	C	D	E	F
790-108	51	15	8	16	55	42
790-116	53	15	16	16	57	45
790-124	78	15	24	16	83	58
790-140	97	15	40	16	100	73

Shield (screen) clamps

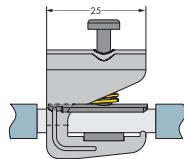
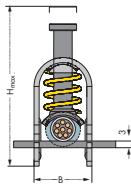

Description		Diameter of Connectable Conductor	Item No.	Pack. Unit
Shield (screen) clamps	H _{max} 40 mm, B 10 mm	1.5 mm/0.059 in to 6.5 mm/0.256 in	791-107	50
	H _{max} 47 mm, B 17 mm	5 mm/0.197 in to 11 mm/0.434 in	791-111	50
	H _{max} 63 mm, B 23 mm	10 mm/0.394 in to 17 mm/0.670 in	791-117	50
	H _{max} 78 mm, B 30 mm	16 mm/0.631 in to 24 mm/0.946 in	791-124	50

Note: Not for ground connections!

Accessories for Shield (Screen) Clamping Saddles and Shield (Screen) Clamps

Carrier with grounding foot



Description	Item No.	Pack. Unit
Carrier with grounding foot bar 90° to the rail, 10 mm (0.394 in) x 3 mm (0.118 in), bar a. foot - Cu with tin plating, 45 mm/1.774 in long	790-113	25
Carrier with grounding foot bar parallel to the rail, 10 mm (0.394 in) x 3 mm (0.118 in), bar a. foot - Cu with tin plating, 15 mm/0.591 in long	790-110	25
Carrier with grounding foot bar parallel to the rail, 10 mm (0.394 in) x 3 mm (0.118 in), bar a. foot - Cu with tin plating, 25 mm/0.986 in long	790-112	25
Carrier with grounding foot bar parallel to the rail, 10 mm (0.394 in) x 3 mm (0.118 in), bar a. foot - Cu with tin plating, 45 mm/1.774 in long	790-114	25
Carrier with 2 grounding feet bar parallel to the rail, 10 mm (0.394 in) x 3 mm (0.118 in), bar a. foot - Cu with tin plating, 125 mm/4.929 in long	790-115	25

Suitable shield (screen) clamping saddle or shield (screen) clamps for carrier with grounding foot 790-110 = 790-108; Carrier with grounding foot 790-112 = 790-108, 790-116, 791-111, 791-117; Carrier with grounding foot 790-114 = 790-108, 790-116, 790-124, 790-140, 791-107, 791-111, 791-117, 791-124

Carrier rail

Stand off

Shield termination



Description	Item No.	Pack. Unit
Carrier rail special slotted, 1000 mm/3'.3" long, Cu with tin plating, special lengths on request	790-145	1
Stand off for special slotted carrier rail, use M 5 size screw	790-144	200 (2x100)
Shield termination including cable tie for shield diameter 5 mm /0.197 in to 10 mm /0.394 in	709-350	100 (4x25)
	709-352	100 (4x25)

Straight busbar

Isolated mounting foot

Isolated mounting foot

U-shaped busbar

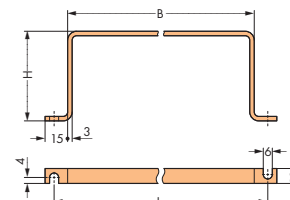

Description	Item No.	Pack. Unit
Straight busbar, 10 mm (0.394 in) x 3 mm (0.118 in), bar - Cu with tin plating	1000 mm/3'.3" long	210-133
	30 mm/1.181 in long	790-133
	50 mm/1.969 in long	790-134
Isolated mounting foot	for busbar, with standard screw M 4 x 8 mm	790-100
Isolated mounting foot	for busbar, with sheet metal screw (3.5 x 9) mm	790-101
U-shaped busbar, 10 mm (0.394 in) x 3 mm (0.118 in), Cu with tin plating	Dimensions (W x H x L) mm; 63 x 60 x 83	790-190
	Dimensions (W x H x L) mm; 100 x 60 x 118	790-191
	Dimensions (W x H x L) mm; 63 x 35 x 83	790-192
	Dimensions (W x H x L) mm; 100 x 35 x 118	790-193

Busbar carrier

Busbar carrier, angulate

Busbar carrier, angulate

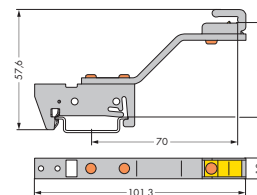
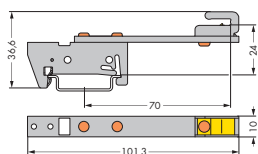

Description	Item No.	Pack. Unit
Busbar carrier	for busbars, 10 mm (0.394 in) x 3 mm (0.118 in) - Cu with tin plating	790-300
Busbar carrier, angulate	for busbars, 10 mm (0.394 in) x 3 mm (0.118 in) - Cu with tin plating	790-301

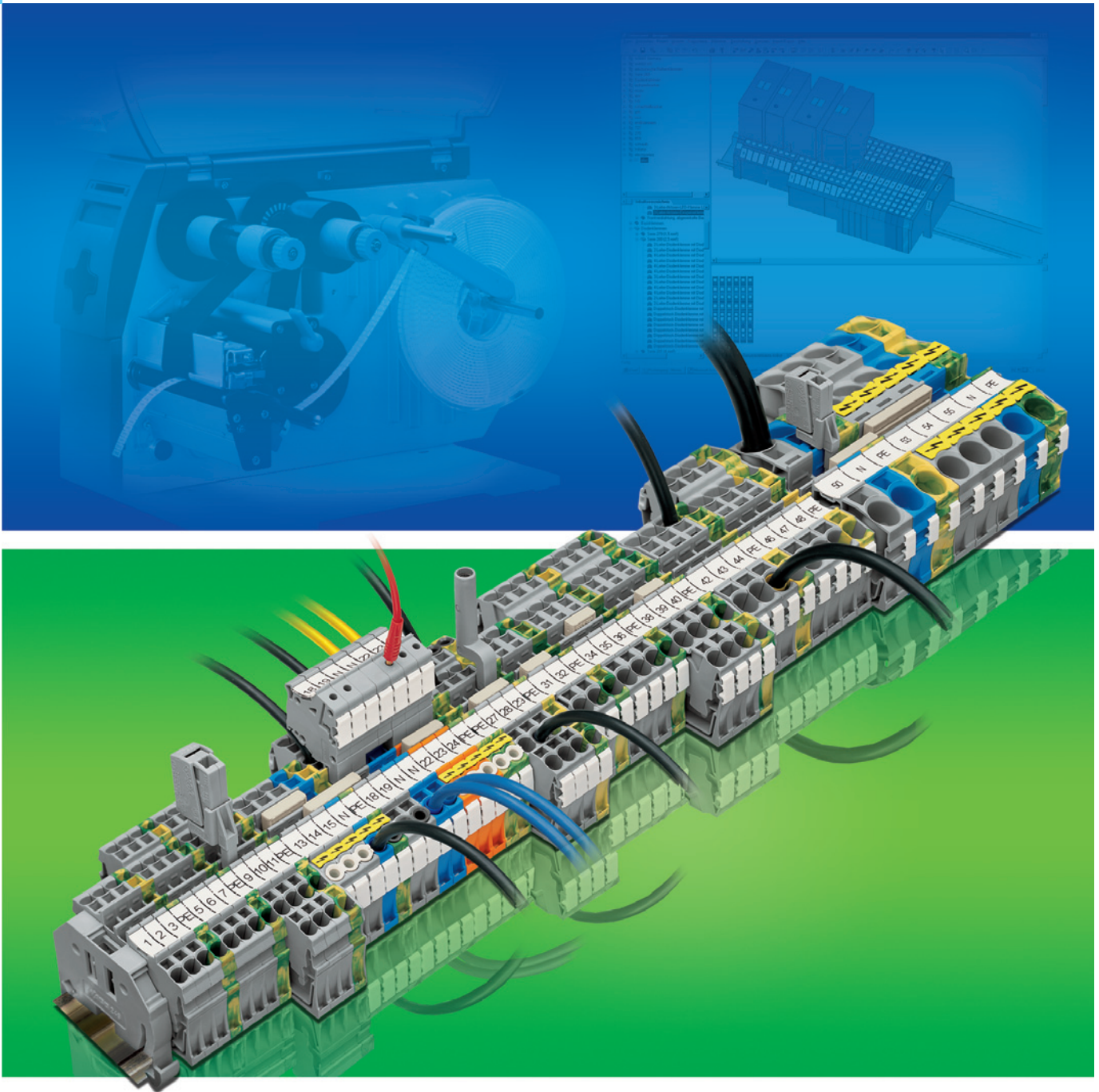

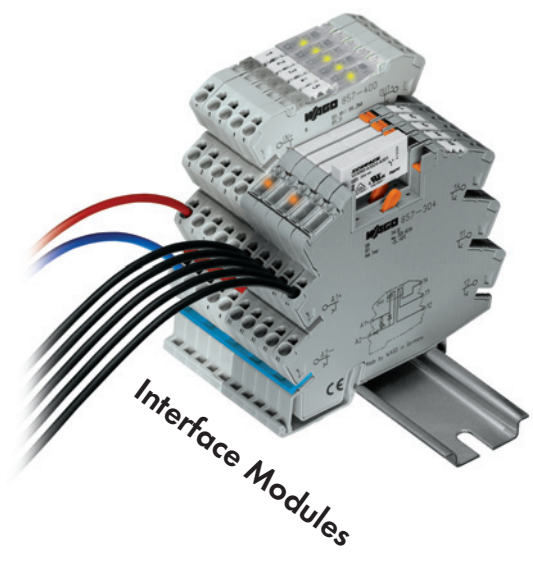

Interface Modules



WAGO-I/O-SYSTEM 750



• The benefits of ProServe are at your disposal every day. With unique features such as accuracy checking, ProServe does a lot of the work for you, therefore saving you time and money.

Immediate access to professional and sophisticated services allows for error-free applications, higher flexibility in your daily business and better customer service. With 50 years of WAGO expertise at your disposal, put ProServe to work for you in your next application.

Configuration and marking of rail assemblies and I/O nodes, stand-alone or in combination with CAE systems.

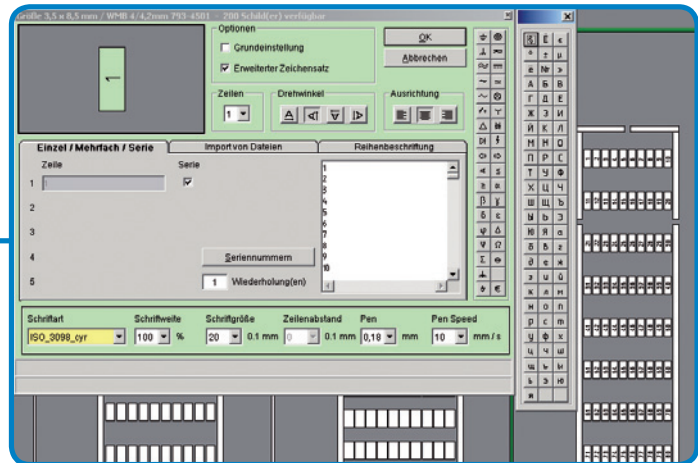

smartMARKING

- Extensive import functions from CAE systems, MS Office and WAGO smartDESIGNER
- WYSIWYG marking
- Automatic plotter calibration
- Extensive library including marker carriers
- Symbol library
- Text length checking
- Different languages available
- Output of East European characters
- Fully compatible with EG 450 engraving unit
- Direct output on thermal transfer printer
- Creation of custom markers for the engraver/plotter



One for all: WAGO ProServe has an interface suitable for most of the standard CAD/CAE systems.

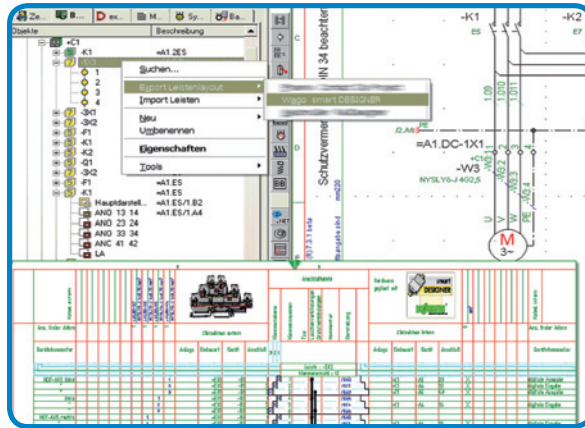

System	Manufacturer	Article master data	Macros	ASCII data to smart-DESIGNER	XML data to smart-DESIGNER	XML data from smart-DESIGNER	XML data from product-LOCATOR
	Aucos	●	●		●	●	●
	Aucotec	●	●		●	●	●
	Aucotec	●	●	●	●	●	●
	Aucotec			●			
	CIM Team	●	●	●	●	●	
	Innotec	●			●	●	
	ECS/MuM	●	●		●	●	
	EPLAN	●	●	●	●	●	●
	Ige-xao	●					
	TCS	●			●	●	
	WS CAD	●	●		●		

ProServe: Planning at a New Level

WAGO ProServe means finding instead of searching, drawing instead of scribbling. ProServe navigates safely through the WAGO range of products, generates parts lists and assembly drawings and even 3D views.

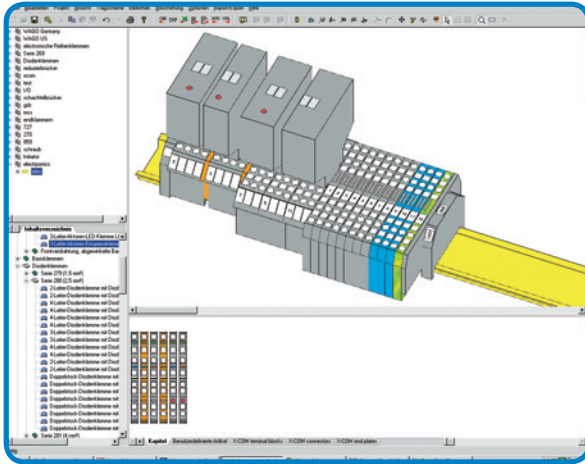

smart

DESIGNER

product

LOCATOR



smartDESIGNER and productLOCATOR

- XML interfaces to CAE and M CAD programs
- Output in PDF and HTML
- Different search functions allow for quick selection of products
- Creation of part lists including product pictures and custom part numbers
- Complex rail assemblies can be easily designed in 3D
- Facility to create custom part numbers
- Creation of custom articles to design third-party products
- Default parts (favourites) can be defined individually for time saving design
- Intelligent, user-optimized accuracy check features
- 15 languages available
- 16,000 items

Marking:

- Direct creation and output of marking data to plotter or thermal transfer printer

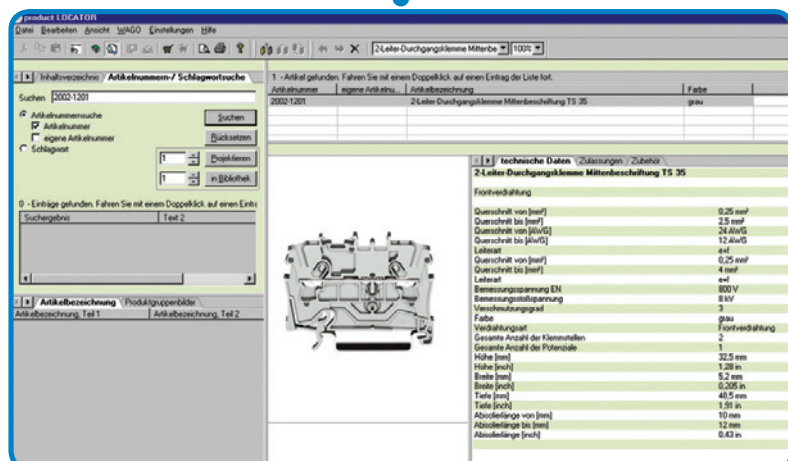

ProServe: Thinking in All Dimensions

Rail-mounted terminal blocks are becoming even more efficient and more complex: Multilevel as well as base receptacle terminal blocks with different conductor entry angles can no longer be represented by a simple view. The 3D view provides a clear representation during planning and assembly. Use our data in your system – now also online.

DXF - Step - IGS - DWG



CAD

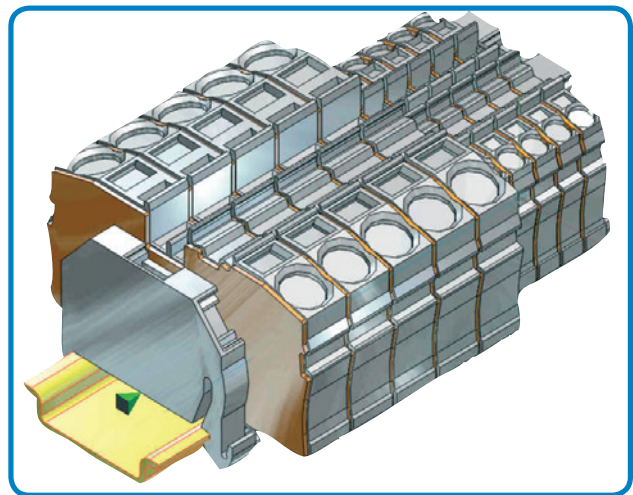

- Create your 2D or 3D CAD files from WAGO ProServe. Now also online!

Benefits in overview:

- Quick design
- Quick ordering
- User-friendly
- Extensive and user-specific documentation
- Network compatibility
- Several software products on a single CD (smartDESIGNER, productLOCATOR, smartMARKING, WAGO SCRIPT)
- A price list is included

...all for free!





Description	Item No.	Pack. Unit
	258-343	1
Thermal Transfer Printer TP 343		
Resolution 300 dpi, incl. ProServe Software; for 2009 and 709 Series marking strips		
Technical Data		
Printing method	Thermal/thermal transfer	
Printhead system	Thin-film transfer head	
Print resolution	300 dpi	
Print speed	up to 76 mm/sec.	
Print width	6 - 104 mm (0.25" - 4.09")	
Print length	up to 990 mm (39")	
RAM memory	2 MB DRAM, 1 MB Flash	
Interfaces	Parallel Centronics (LPT), RS-232 (COM), USB, ETHERNET 10/100 Base T	
Sensors	Label sensor (material end, foil end, bottom reflective sensor)	
Other	2 cardboard cores (104 mm) for ink ribbon rewriter Operating instructions in German and English	
Voltage supply	Universal power supply unit	
Operating voltage	100 V ... 240 V AC / 50 Hz ... 60 Hz	
Dimensions (mm) W x H x L	230 x 200 x 290 (Dimension with winder ca. 450 mm)	
Enclosure	Double-walled plastic	
Weight	1000 g	
Safety Approvals	CE, FCC Class A, UL, CUL, TUV	
Accessories	1 x USB cable; 1 x ETHERNET cable; unwinder set; marking strips (1 x 2009-110); ink ribbon (1 x 258-145)	

Description	Item No.	Pack. Unit
	258-298	1
Thermal Transfer Printer TP 298		
Resolution 300 dpi, incl. ProServe Software and Print Roller (258-178) for WMB Inline and 2009 and 709 Series marking strips		
Technical Data		
Printing method	Thermal/thermal transfer	
Printhead system	Thick-film	
Print resolution	300 dpi	
Print speed	100 mm/sec.	
Print width	108.4 mm	
See-through/reflective sensor	standard	
Processor 32 Bit ColdFire/clock rate	64 MHz	
RAM memory	8 MB RAM	
Program memory	4 MB Flash	
Slot for memory card	CompactFlash Type 1	
Interfaces	ETHERNET 10/100 Base T, RS-232 (COM), USB	
Accessories (optional)	Cutter, external unwinder, external rewriter, memory card Compact Flash Type 16-512 MB	
Operating voltage	100 V ... 240 V AC / 50 Hz ... 60 Hz, PFC	
Dimensions (mm) W x H x L	242 x 274 x 446	
Weight	10000 g	
Operating temperature	10 °C ... 35 °C	
rel. humidity	30 % ... 85 %	
Safety Approvals	CE, FCC class 1	
Accessories	1 x USB cable; 1 x serial cable; marking strips (1 x 2009-110); ink ribbon (1 x 258-149)	

Application table for ink ribbon/markings accessories/printer

Item No.	Width	Ink Ribbon	Marking Accessories	Printer
258-143	60 mm	resin/wax	Labels (paper)	all types
258-144	100 mm	resin/wax	Labels (paper) Wire Marking 211-155 / 211-156	all types
258-145	38 mm	resin	Marking Strip Series 2009 2009-xxx Marking Strip Series 709 709-xxx WMB Inline (not printable with TP 343)	TP 298 & TP 343
258-149	50 mm	resin	Marking Strip Series 2009 2009-xxx Marking Strip Series 709 709-xxx WMB Inline (not printable with TP 343)	TP 298+
258-150	76 mm	resin	Cable Marking 211-111 and 211-121 Labels (polyester) up to 76 mm	all types
258-157	100 mm	resin	Labels (polyester) up to 100 mm	all types

Ink ribbon for labels



Ink ribbon for marker strips



Description	Item No.
Ink ribbon for labels	resin/wax, width 60 mm x 300 m 258-143
Ink ribbon for marker strips and WMB Inline	resin/wax, width 100 mm x 300 m 258-144
	resin, 38 mm x 300 m 258-145
	resin, 50 mm x 300 m 258-149
Ink ribbon for cable marking	76 mm wide x 300 m 258-150
	100 mm wide x 300 m 258-157

All ink ribbons are suitable for TP 298 and TP 343 printers. For detailed ordering information, please refer to the "Application table for ink ribbon/markings accessories/printer"

External coil mounting system



Cutter TP 298



Spare roller TP 298



Description	Item No.
External coil mounting system	for WMB Inline 8,000 markers (2009-135) 258-169
Cutter TP 298	258-161
Spare roller TP 298 for labels	(up to item no. 40.000) 258-162
Spare roller TP 298 for labels	(up to item no. 40.000) 258-177
Spare roller TP 298 for WMB Inline	(up to item no. 40.000) 258-166
Spare roller TP 298 for WMB Inline	(up to item no. 40.000) 258-178
Carrying case for TP 298	258-171
Carrying case for TP 343	258-342
Retractable handle for carrying case TP 298 / TP 343	258-173

WMB Inline



Marking strips



Description	Item No.
WMB Inline, pitch 4 mm, stretchable, 4 mm ... 4.2 mm, on reel	white, 2000 pieces 2009-114
WMB Inline, pitch 5 mm, stretchable, 5 mm ... 5.2 mm, on reel	white, 1500 pieces 2009-115
WMB Inline, pitch 5 mm, stretchable, 5 mm ... 5.2 mm, on reel	white, 8000 pieces 2009-135
Marking strips for TOPJOB®S Series, white, plain, 11 mm wide	50 m coil 2009-110
Marking strips for 870, 869, 862, 270 Series	50 m coil 709-178
white, plain, 7.5 mm wide	
Marking strips for 870, 869, 862, 270 Series	50 m coil 709-177
transparent, plain, 7.5 mm wide	

Marker card

Marker card (12 mm)
for Plotter

Labels on roll

Labels on DIN A4
sheets

Dimensions of self-laminating label

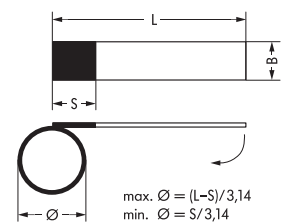

Description		Item No.
Marker card for TT Printer	12 mm	211-121
	23 mm	211-111
	12 mm	211-120
	(258-370 Carrier Plates are required for plotting)	
Marker card for Plotter	23 mm	211-110
	(258-370 Carrier Plates are required for plotting)	
Labels on roll for thermal transfer printer	Marker surface "S"=8 mm, "B"=18 mm, "L"=35 mm for max. cable	211-155
	Ø 9 mm, 9.000 labels per roll	
	Marker surface "S"=13 mm, "B"=23 mm, "L"=51 mm for max. cable	211-156
	Ø 12 mm, 5.000 labels per roll	
Labels on DIN A4 sheets for laser printer (258-383 Carrier Plates are required for plotting)	Marker surface "S"=9 mm, "B"=17 mm, "L"=35 mm for max. cable	211-150
	Ø 8 mm, 70 labels per roll	
	Marker surface "S"=13 mm, "B"=21 mm, "L"=56 mm for max. cable	211-151
	Ø 14 mm, 32 labels per roll	
Marking sleeve 12 mm, for wire Ø	1.6 mm ... 3.2 mm or 0.25 mm ² ... 1.5 mm ²	211-112
	2.2 mm ... 4.5 mm or 0.5 mm ² ... 4 mm ²	211-113
	3.7 mm ... 5.9 mm or 2.5 mm ² ... 6 mm ²	211-114
	4.8 mm ... 7.5 mm or 6 mm ² ... 16 mm ²	211-115
Marking sleeve 23 mm, for wire Ø	1.6 mm ... 3.2 mm or 0.25 mm ² ... 1.5 mm ²	211-122
	2.2 mm ... 4.5 mm or 0.5 mm ² ... 4 mm ²	211-123
	3.7 mm ... 5.9 mm or 2.5 mm ² ... 6 mm ²	211-124
	4.8 mm ... 7.5 mm or 6 mm ² ... 16 mm ²	211-125
Marking sleeve for cable tie	23 mm, for wires from 10 mm ²	211-129
Cable tie (2.5 x 100) mm		807-090/101-100
Label for I/O marking	Plotter, 12 x 7 mm (258-371 Carrier Plates are required for plotting)	211-211
Marking strips	15 mm, white 50 m roll	210-701
Receptacle for marking strips	transp. 1 m long	709-120
Continuous label	3 mm, white 12 lengths at 25 m	210-732
Label roll	70 x 100 mm, white 500 pieces/reel	210-703
Label roll	70 x 100 mm, silver 500 pieces/reel	210-704
Label roll	6 x 15 mm, white 3000 pieces/reel	210-705
Label roll	6 x 15 mm, yellow 3000 pieces/reel	210-705/000-002
Label roll	9 x 15 mm, white 3000 pieces/reel	210-706
Label roll	9 x 15 mm, yellow 3000 pieces/reel	210-706/000-002
Label roll	8 x 20 mm, white 3000 pieces/reel	210-707
Label roll	8 x 20 mm, yellow 3000 pieces/reel	210-707/000-002
Label roll	9.5 x 25 mm, white 3000 pieces/reel	210-708

8 Engraving Plotters with Engraver EG 450

Plotter IP 350 A3 / Plotter IP 350 A4

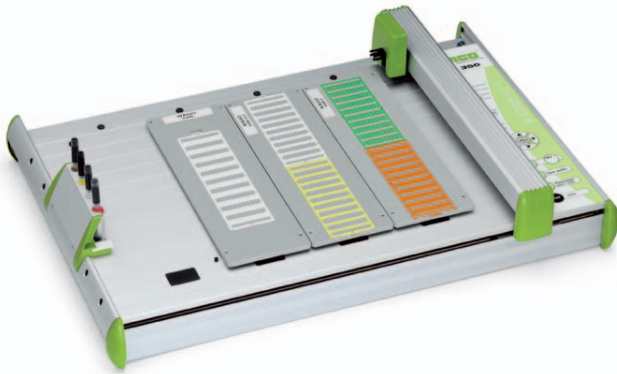

Description	Item No.	Pack. Unit
Plotter IP 350 A3	258-350	1
incl. ProServe Software		
Plotter IP 350 A4	258-451	1
incl. ProServe Software		
Technical Data		
Plot area	440 mm x 305 mm (258-350) 220 mm x 305 mm (258-451)	
Interfaces	parallell (centronics); USB 1.1	
Language	based on HP-GL 7475A	
Data buffer	16 MB	
Speed	max. 400 mm/sec.	
Drive system	two phase stepper motor	
Pen storage unit	max. 4 pens with best possible sealing	
Plotter pen	Special plotter pens with HP receptacle	
Addressable resolution	0.01 mm	
Repeatability (accuracy)	0.05 mm	
Repeatability when changing the pen	0.05 mm using pens of best quality	
Voltage supply	via separate desktop power supply unit equipped with exchangeable supply line	
Operating voltage	120 V ... 240 V AC / 50 Hz ... 60 Hz	
Voltage range	90 V ... 264 V AC	
Current consumption (internal)	0.3 A max. at 220 V AC	
Dimensions (mm) W x H x L	125 x 660 x 440	
Weight	11069 g	
Operating temperature	10 °C ... 35 °C	
rel. humidity	35 % ... 75 %	
Safety Approvals	acc. to UL-UL1950 CSA-950/VDE EN60950	
Immunity to interference	acc. to FCC Class B FCC Part 15 and VDE Class B EN 55022	

Description	Item No.	Pack. Unit
EG 450 Engraver	258-450	1
as an extension of IP 350 Flat Plotter. Consisting of "EC 450" Control Unit and "VC 450" Vacuum Cleaner, including graver 0.3 mm + 0.4 mm		
Technical Data		
1. Engraving spindle		
Speed	min. 5000 rpm, max. 50000 rpm	
Torque	6 Ncm	
Frequency	83 Hz ... 830 Hz	
Energy consumption max.	60 W	
Collets	Diameter of mandrel 3 mm	
Tensioning mechanism	Head tension	
Run-out with collet	0.03 mm	
Motor type	three-phase, asynchronous, brushless	
Enclosure	Aluminium	
Clamping diameter	25 mm	
Type of ball bearing	Steel, permanent lubrication	
Cooling system	integrated fan	
Field of application	exclusively engraving	
Operating time of bearing	min. 1000 hrs if handled properly	
Notice: Never clean engraving spindle using compressed air, do not use lubricants when engraving.		
2. Control unit VEB 500		
Operating voltage	100 V ... 240 V AC / 50 Hz ... 60 Hz	
3. Vacuum cleaner VC 500		
Vacuum cleaner bag	Typ Y98	
General Specifications		
Dimensions (mm) W x H x L	240 x 290 x 315 Control unit + Vacuum cleaner (an top of each other)	
Weight	Engraving spindle + Control unit + Vacuum cleaner + Accessories 8000 g	

Full plotter package

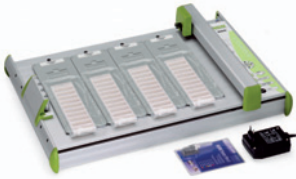

Description	Item No.
Version 1 1 plotter incl. power supply and centronics cable; 1 ProServe Software; 4 WMB carrier plates 5 mm/0.197 in; 20 WMB marker cards 5 mm/0.197 in; 1 plotter pen, line width 0.25 mm disposable; 1 plotter pen, line width 0.35 mm disposable	258-350/000-001
Version 2 1 plotter incl. power supply and centronics cable; 1 ProServe Software; 4 WSB carrier plates; 20 WSB marker cards; 1 plotter pen, line width 0.25 mm disposable; 1 plotter pen, line width 0.35 mm disposable	258-350/000-002
Version 3 1 plotter incl. power supply and centronics cable; 1 ProServe Software; 2 WMB (5 mm/0.197 in) carrier plates; 2 miniature WSB carrier plates; 10 WMB (5 mm/0.197 in) marker cards; 10 miniature WSB marker cards; 1 plotter pen, line width 0.25 mm disposable; 1 plotter pen, line width 0.35 mm disposable	258-350/000-003
Version 4 1 plotter incl. power supply and centronics cable; 1 ProServe Software; 1 WMB carrier plate 5 mm/0.197 in; 1 WSB carrier plate 5 mm/0.197 in; 1 miniature WSB carrier plate; 1 WSB carrier plate 4 mm/0.157 in; 5 WMB marker cards 5 mm/0.197 in; 5 WSB marker cards 5 mm/0.197 in; 5 miniature WSB marker cards; 5 WMB marker cards 4 mm/0.157 in; 1 plotter pen, line width 0.25 mm disposable; 1 plotter pen, line width 0.35 mm disposable	258-350/000-004

Plotter is suitable for marking any type of WAGO marker card or competitor's markers. Includes the ProServe DVD-ROM and WAGO smartMARKING software.

WAGO plotter pen (disposable)
0.18 mm line width



WAGO plotter pen (disposable)
0.25 mm line width



WAGO plotter pen (disposable)
0.35 mm line width



Service kit



Description	Item No.
WAGO plotter pen line width 0.18 mm/0.007 in	258-226
line width 0.25 mm/0.010 in	258-227
line width 0.35 mm/0.014 in	258-228
line width 0.50 mm/0.020 in	258-229
WAGO ink cartridges black, for permanent marking, not refillable (5 x 1 ml)	258-141
WAGO plotter pen (disposable) line width 0.18 mm/0.007 in	258-326
line width 0.25 mm/0.010 in	258-327
line width 0.35 mm/0.014 in	258-328
Cover	258-146
Service kit (4 alternative pen storage units)	258-147
WAGO cleaning set suitable for cleaning all EKS Pens	258-139
WAGO pen cleaner	258-140
Graver set line width 0.2/0.3/0.4/0.5/0.7/1.0 mm	258-452
Graver line width of graver 0.2 mm	258-452/000-002
line width of graver 0.3 mm	258-452/000-003
line width of graver 0.4 mm	258-452/000-004
line width of graver 0.5 mm	258-452/000-005
line width of graver 0.7 mm	258-452/000-007
line width of graver 1.0 mm	258-452/000-010
Vacuum cleaner bag for Engraver EG 450	258-457

WAGO plotter pens are suitable for any kind of smooth surfaces. No additional adapter is required.



Description		Item No.	
Carrier plates for marker cards	WSB 5 mm/0.197 in (209-501)	258-361	
	WSB 4 mm/0.157 in (209-701)	258-362	
	Miniature WSB (248-501)	258-363	
	Group marking carriers (209-112)	258-364	
	T-marking strips (209-290)	258-365	
	WCB (249-200)	258-366	
	WTB (799-501)	258-367	
	WMB 5/5.2 mm (793-5501); WMB 4/4.2 mm (793-4501)	258-368	
	Marker tags (209-199 + 209-200)	258-369	
	Marker strips (2009-110 + 2009-130 and 790-...)	258-410	
	WMB-Inline (2009-115 + 2009-135)	258-412	
	Carrier plates for murrplastik	MP-400; KS 4/12, 4/18, 4/23, 4/30	258-370
		MP-401; KES, KLG, KMR, KPX, KS 15x17/27/49/67, KSA, KSF, KSI, KSK, KSO, KSS, KTE, KWI, SKS, WGO, KAB	258-371
		BS 5/6	258-397
KPX		258-396	
KSEX; 10/500		258-470	
KSEX; 18/500		258-471	
Universal		258-398	
Carrier plates for Conta-Clip	ZBM	258-372	
	ZB	258-373	
	ZBN	258-374	
	ZBFM	258-375	
	BNZ	258-377	
	BN-ZB	258-378	
	SS-ZB	258-379	
	LBHZ	258-380	
	PAB	258-381	
	GPE	258-382	
Universal Carrier plates	DIN A4	258-383	
	DIN A3	258-472	
Carrier plates for Weidmüller	MC Universal	258-387	
	MC SF4-6	258-388	
Carrier plates for Wörtz/Allen Bradley	Universal	258-389	
Carrier plates for Möller	XB M22-XST	258-390	
Carrier plates for Partex	PA+1	258-391	
	PA+2	258-392	
	PK2 PVC	258-393	
	PA+ 2	258-399	
Carrier plates for ABB Entrellec	Universal	258-394	
	Siemens SPS	258-473	

Marking System

WMB Multi marking system



Miniature quick marking card



Colored marker cards

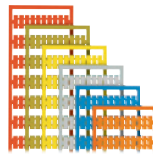

WMB Inline



Description		Item No.	Item No.	Pack. Unit
WMB Multi marking system for terminal block width 3.5 mm	plain	793-3501		5 cards
WMB Multi marking system for terminal block width 4 - 4.2 mm stretchable 4 - 4.2 mm	plain	793-4501		5 cards
WMB Multi marking system for terminal block width 5 - 17.5 mm stretchable 5 - 5.2 mm	plain	793-5501		5 cards
Miniature WSB quick marking system for terminal block width 5 - 17.5 mm	plain	248-501		5 cards
Additional item no. for colored marker cards				
	yellow		.../000-002	5 cards
	red		.../000-005	5 cards
	blue		.../000-006	5 cards
	gray		.../000-007	5 cards
	orange		.../000-012	5 cards
	light green		.../000-017	5 cards
	green		.../000-023	5 cards
	violet		.../000-024	5 cards
WMB Inline, pitch 4 mm, stretchable, 4 mm ... 4.2 mm, on reel	white, 2000 pieces	2009-114		
WMB Inline, pitch 5 mm, stretchable, 5 mm ... 5.2 mm, on reel	white, 1500 pieces	2009-115		1 Coil
WMB Inline, pitch 5 mm, stretchable, 5 mm ... 5.2 mm, on reel	white, 8000 pieces	2009-135		1 Coil



Separation of a strip from the WMB Marker card



Stretching of a strip, stretchable from 4 mm up to 4.2 mm, stretchable from 5 mm up to 5.2 mm

Group marker carrier

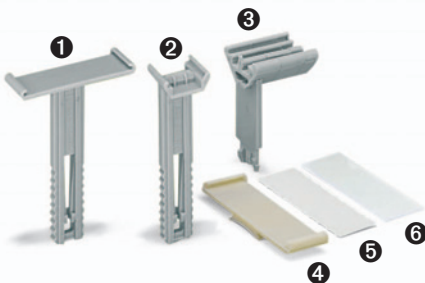

Group marker carrier adjustable in height

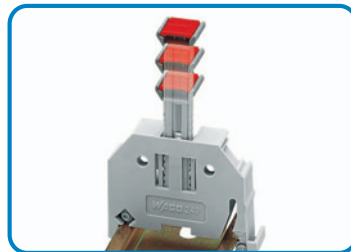

Group marker carrier 209-112 to be on 788 Series relay sockets with pluggable miniature switching

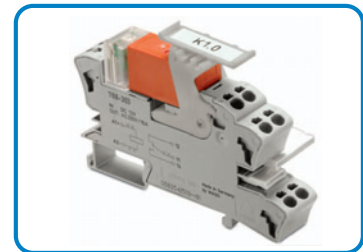

Description		Item No.	Pack. Unit
Group marker carrier adjustable in height (43.5 mm ... 60 mm), for end stops 249-116 and 249-117	for 1 marker card or self-adhesive label and transparent cover protection	249-119 ❶	50 (2x25)
	for 2 WSB Quick markers or 1 x continuous marking strip	249-118 ❷	100 (4x25)
	with marker surface 41 mm/1.61 in, 6 mm/0.23 in wide	249-120	50 (2x25)
Group marker carrier	for up to 3 WMB markers, 15 mm/0.591 in wide	209-140 ❸	50 (2x25)
Group marker carrier	for snapping into screwless end stops, 10 mm/0.394 in wide	209-112 ❹	50 (1x50)
Marker card	from white cardboard, for self-marking, 100 markers per sheet	209-113 ❺	1 (1x1)
Protection cover	transparent	209-114 ❻	50 (1x50)

Wire marking

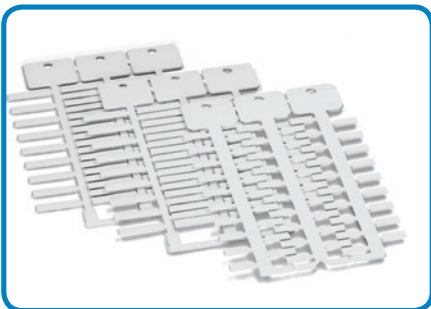

The following marker cards are available:
Marker cards for plotter marking ...



... or marker cards on roll
for thermal transfer printing



Slide the marker card into the marking sleeve
receptacle.
Changing the marking is also
possible after the wire has been connected



Remove the rest of the card by twisting it off



Fix the 211-129 marking sleeve using cable ties to
individual wire or cable



Cable marking



Self-laminating labels are available on A4 sheets
for the laser printer (plotter) ...



... or are supplied on roll for the thermal transfer
printer



Remove the printed label from the sheet or roll
and wrap it around the wire or cable.
The transparent laminate protects the marking

Marking sleeve 12 mm

Marking sleeve 23 mm

Marking sleeve 23 mm, for cable tie

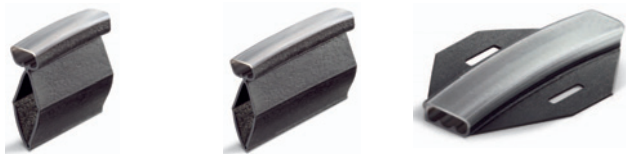

Description		Item No.	Pack. Unit
Marking sleeve* 12 mm, for wire Ø	1.6 mm ... 3.2 mm or 0.25 mm ² ... 1.5 mm ²	211-112	2000
	2.2 mm ... 4.5 mm or 0.5 mm ² ... 4 mm ²	211-113	2000
	3.7 mm ... 5.9 mm or 2.5 mm ² ... 6 mm ²	211-114	1000
	4.8 mm ... 7.5 mm or 6 mm ² ... 16 mm ²	211-115	1000
Marking sleeve* 23 mm, for wire Ø	1.6 mm ... 3.2 mm or 0.25 mm ² ... 1.5 mm ²	211-122	2000
	2.2 mm ... 4.5 mm or 0.5 mm ² ... 4 mm ²	211-123	2000
	3.7 mm ... 5.9 mm or 2.5 mm ² ... 6 mm ²	211-124	1000
	4.8 mm ... 7.5 mm or 6 mm ² ... 16 mm ²	211-125	1000
Marking sleeve* for cable tie	23 mm, for wires from 10 mm ²	211-129	1000
Cable tie (2.5 x 100) mm		807-090/101-100	1000

Marker card

Marker card (12 mm) for Plotter

Marker card (23 mm) for Printer

Marker card (23 mm) for Plotter



Description		Item No.	Pack. Unit
Marker card for TT Printer	23 mm	211-111	1
	Plotter, 23 mm (258-370 Carrier Plates are required for plotting)	211-110	18
Marker card for TT Printer	12 mm	211-121	1
	Plotter, 12 mm (258-370 Carrier Plates are required for plotting)	211-120	30

Labels on roll

Labels on DIN A4 sheets

Dimensions of self-laminating label

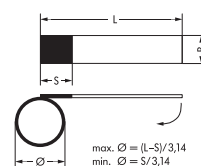

Description		Item No.	Pack. Unit
Labels on roll for thermal transfer printer	Marker surface "S"=8 mm, "B"=18 mm, "L"=35 mm for max. cable Ø 9 mm, 9.000 labels per roll	211-155	1
	Marker surface "S"=13 mm, "B"=23 mm, "L"=51 mm for max. cable Ø 12 mm, 5.000 labels per roll	211-156	1
Labels on DIN A4 sheets for laser printer (258-383 Carrier Plates are required for plotting)	Marker surface "S"=9 mm, "B"=17 mm, "L"=35 mm for max. cable Ø 8 mm, 70 labels per roll	211-150	20
	Marker surface "S"=13 mm, "B"=21 mm, "L"=56 mm for max. cable Ø 14 mm, 32 labels per roll	211-151	25

8 Carrier Rails and Angled Support Bracket

Steel carrier rail acc. to EN 60715	Steel carrier rail	Steel carrier rail acc. to EN 60715
--	--------------------	--

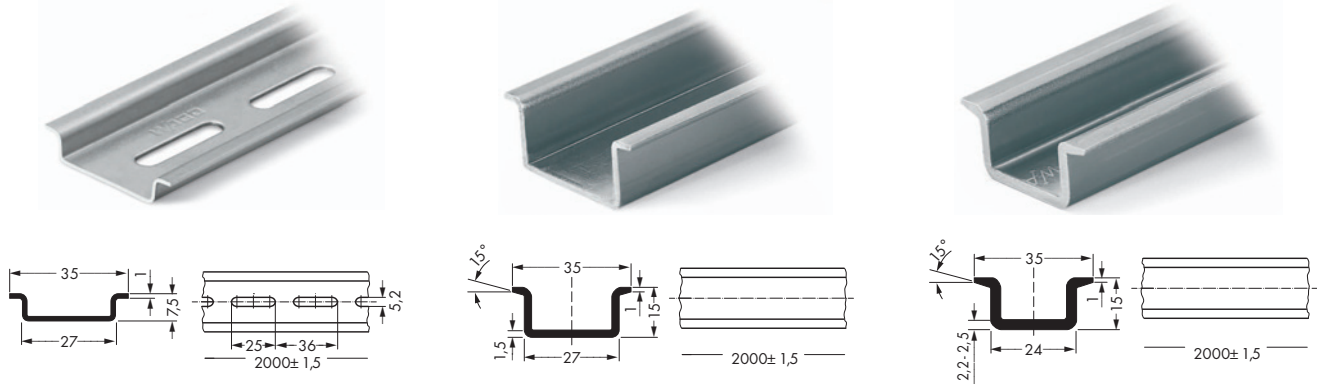

Item No.	Pack. Unit	Item No.	Pack. Unit	Item No.	Pack. Unit
Steel rail, I_N 76 A (referred to a length of 1 m) 35 x 7.5 mm, 1 mm/0.039 in thick, 2 m long, unslotted		Steel rail, I_N 125 A (referred to a length of 1 m) 35 x 15 mm, 1.5 mm/0.059 in thick, 2 m long, unslotted		Steel rail, I_N 125 A (referred to a length of 1 m) 35 x 15 mm, 2.3 mm/0.091 in thick, 2 m long, unslotted	
210-113	10	210-114	10	210-118	10
Hole width 25 mm; hole spacing 36 mm, slotted		Steel rail, I_N 125 A (referred to a length of 1 m) 35 x 15 mm, 1.5 mm/0.059 in thick, 2 m long, slotted			
210-112	10	210-197	10		
Hole width 18 mm; hole spacing 25 mm, slotted					
210-115	1				

Copper carrier rail	Aluminum carrier rail	Angled support bracket
---------------------	-----------------------	------------------------

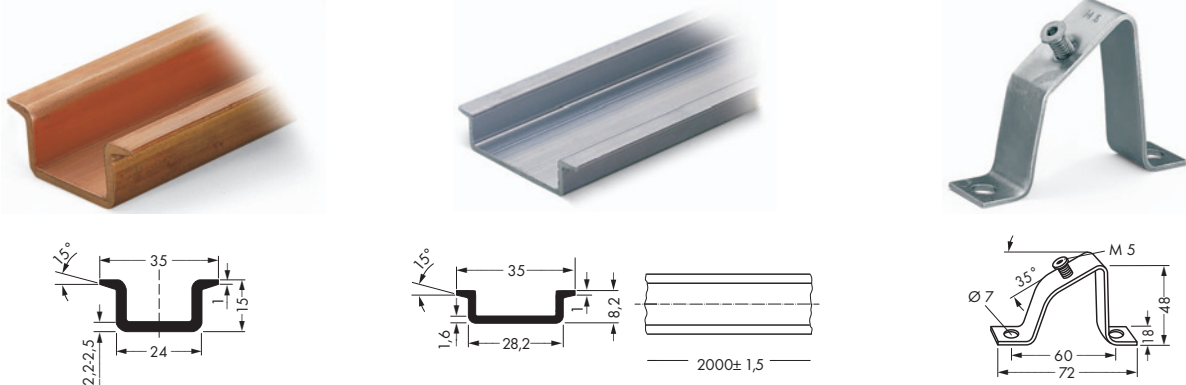

Item No.	Pack. Unit	Item No.	Pack. Unit	Item No.	Pack. Unit
Copper carrier rail, I_N 309 A (referred to a length of 1 m)		Aluminum carrier rail, I_N 76 A (referred to a length of 1 m)		Angled support bracket, without screw	
210-198	10	210-196	10	210-148	10
				Screw M 5 x 8	100
				210-149	100

Screwless End Stops and Rail End Cap for DIN 35 Rail

End stop for DIN 35 rail End stop width 6 mm / 0.236 in	End stop for DIN 35 rail End stop width 10 mm / 0.394 in	Rail end cap, for DIN 35 rail (7.5 mm/0.29 in high)
--	---	--

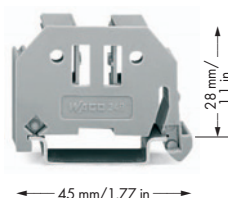
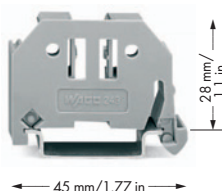

Item No.	Pack. Unit	Item No.	Pack. Unit	Item No.	Pack. Unit
End stop , for DIN 35 rail 6 mm/0.236 in wide		End stop , for DIN 35 rail 10 mm/0.394 in wide		Rail end cap , for DIN 35 rail (7.5 mm/0.29 in high)	
249-116	100 (4 x 25)	249-117	50 (2 x 25)	209-109	50

Snap on - That's it!

Assembling the WAGO screwless end stops is as simple and quick as snapping a WAGO railmounted terminal block onto the rail.

Without any tools!

This way rail-mounted terminal blocks are safely secured at low cost against any movement on all carrier rails DIN 35 acc. to DIN EN 50022 (35 x 7.5 mm; 35 x 15 mm).

Entirely without screws!

The „secret“ of the excellent tight fit lies in the two small clamping plates which keep the end stop in position, even if the rails are mounted vertically.

Simply snap on - and forget!

In addition, costs are considerably reduced when using large numbers of end stops.

A further advantage is that three marker receptacles for all WAGO marker systems for rail-mount terminal blocks and a snap-in hole for WAGO adjustable height group marker carriers offer individual marking possibilities.

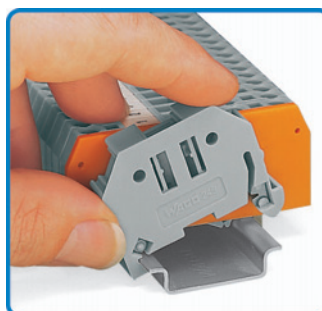



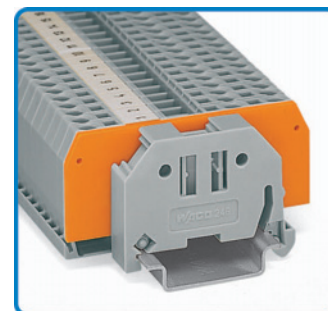
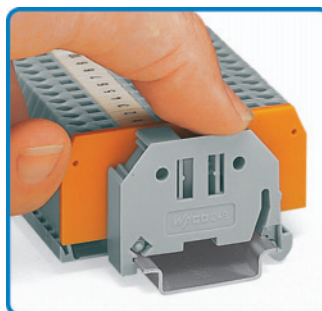
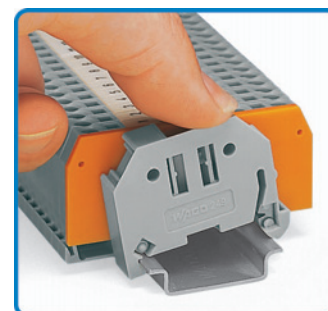

Snap on ...



... that's it!

Microstrip wire stripper 0.14 mm ² ... 1.5 mm ² /AWG 24 ... 16 "solid" and "stranded" Wire cutter up to 1.5 mm ² /AWG 16 "solid" and "stranded"	Quickstrip 10 wire stripper 0.02 mm ² ... 10 mm ² /AWG 28 ... 8 "stranded" (6 mm ² /AWG 10 "solid") Wire cutter up to 10 mm ² /AWG 8 "stranded" (1.5 mm ² /AWG 16 "solid")	Quickstrip 16 wire stripper 4 mm ² ... 16 mm ² Wire cutter up to 10 mm ² /AWG 12 ... 6 "stranded" (1.5 mm ² /AWG 16 "solid")
---	--	--



Item No.	Pack. Unit	Item No.	Pack. Unit	Item No.	Pack. Unit
Microstrip wire stripper		Quickstrip 10 wire stripper		Quickstrip 16 wire stripper	
206-501	1	206-124	1	206-125	1
Item No.	Pack. Unit	Item No.	Pack. Unit	Item No.	Pack. Unit
Spare stripping unit complete		Standard blade cassette		Blade cassette 16 mm²	
		0.02 mm ² ... 10 mm ² /AWG 34 ... 8		4.0 mm ² ... 16 mm ² /AWG 12 ... 6	
 206-502	1	 206-126	1	 206-128	1
Spare blade for wire cutter		"V" blade cassette			
		0.02 mm ² ... 4 mm ² /AWG 34 ... 12 for PTFE			
 206-503	10	 206-127	1		

- Automatic adjustment to wire size.
- No damage to wire strands.
- Gripping pressure of jaws adjusts automatically to wire insulation diameter.
- Full cycle strip - jaws open after stripping, ensures no nicked strands.
- Exact strip length may be set by sliding of red setting stop.
- Replaceable stripping jaw assembly.
- Self-sharpening, fully protected wire cutter, also replaceable.*
- Glass fiber reinforced polyamide tool body.

* for Microstrip



Cutting of wire.



Stripping of wire.

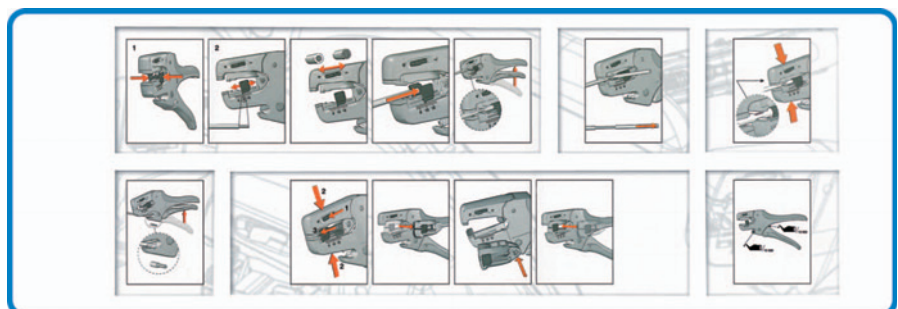

Operating instructions are enclosed in the packaging.

Voltage Tester, Testboy and Cable Cutter

<p>Cable cutter acc. to VDE for copper and aluminum wires up to 35 mm²/AWG 2</p> <p>Weight 200 g</p>	<p>Voltage tester "Profipol" 12 V to 400 V AC 12 V to 500 V DC</p> <p>Weight 138 g</p>	<p>Testboy</p>
---	--	----------------



Item No.	Pack. Unit	Item No.	Pack. Unit	Item No.	Pack. Unit
Cable cutter		Voltage tester "Profipol"		Testboy,	
206-118	1	Voltage range		with integrated flashlight	
		12 V to 400 V AC		Voltage range 120 V to 1000 V AC	
		12 V to 500 V DC		206-804	1
		LED indication			
		12 V, 50 V, 100 V, 230 V, 400 V AC			
		12 V, 60 V, 120 V, 280 V, 500 V DC			
		Degree of protection IP65			
		Operating time 30 s max.			
		Temperature range -10° to +50°C			
		206-802	1		



Cutting og cable

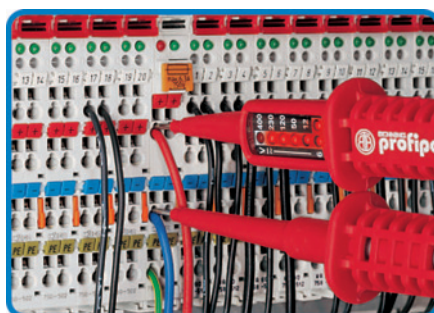

Voltage testing at the WAGO-I/O-SYSTEM 750



A device that will reliably detect AC voltages in cables, sockets, fuses, switches, connector boxes, etc.

- LED band provides clear voltage range readings (white scale = AC voltage red scale = DC voltage)
- LED indication of polarity
- double-pole voltage testing
- IP65 type of protection
- switching is not necessary
- 85 cm long highly flexible and nonskid test cable

The following can be detected by the WAGO

Testboy:

- Live conductors
- Line breaks
- Blown fuses (in cartridges or holders)
- Defective switches
- Defective lamps in strings of lights

<p>Operating tool with partially insulated shaft for optimum handling of terminal blocks</p>	<p>Operating tool with partially insulated shaft - Set -</p>	
--	--	--



Item No.	Pack. Unit	Item No.	Pack. Unit
Operating tool, with partially insulated shaft, type 1, blade (2.5 x 0.4) mm for 279, 726, 727, 2000, 2001 Series		Operating tool, with partially insulated shaft, - Set -	
210-719	1	210-722	1
Operating tool, with partially insulated shaft, type 2, blade (3.5 x 0.5) mm for 260, 261, 262, 264, 270, 280, 281, 290, 775, 776, 777, 769, 780, 781, 869, 870, 880, 2002, 2003, 2004, 2005, 2022 Series			
210-720	1		
Operating tool, with partially insulated shaft, type 3, blade (5.5 x 0.8) mm for 282, 283, 284, 285, 782, 783, 784, 785, 2006, 2010, 2016 Series			
210-721	1		

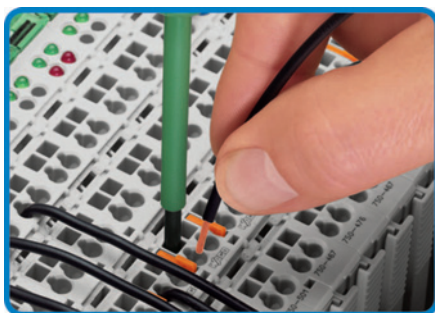

Wiring example showing WAGO-I/O-SYSTEM 750

The operating tool are particularly appropriate for the operation of front-entry terminal blocks and connectors. (The picture shows the WAGO-I/O-SYSTEM 750)

Cable Strippers

<p>Cable stripper for round cables with an outer diameter from 2.5 mm to 11 mm Ø</p>	<p>Cable stripper for round cables with an outer diameter from 4.5 mm to 40 mm Ø</p>	
--	--	--



Item No.	Pack. Unit	Item No.	Pack. Unit
Cable stripper for round cables with an outer diameter from 2.5 mm to 11 mm Ø		Cable stripper for round cables with an outer diameter from 4.5 mm to 40 mm Ø	
206-171	1	206-174	1
Spare blade for 2.5 mm to 11 mm Ø		Spare blade for 4.5 mm to 40 mm Ø	
206-170	1	206-173	1

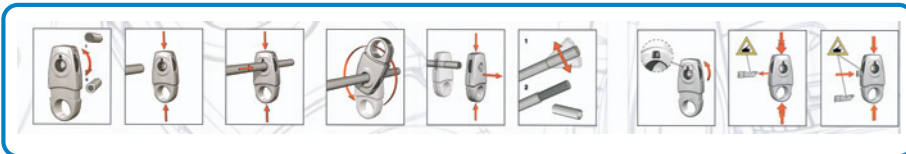

Handling instructions for 206-171 cable stripper

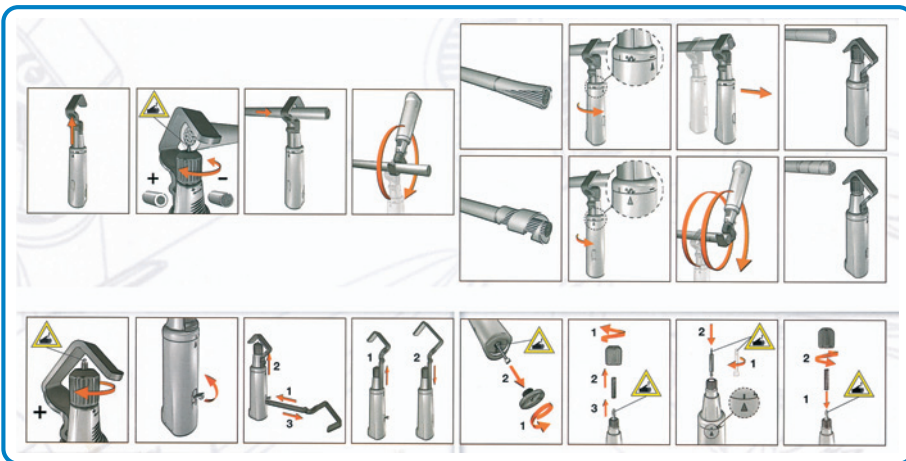

Handling instructions for 206-174 cable stripper

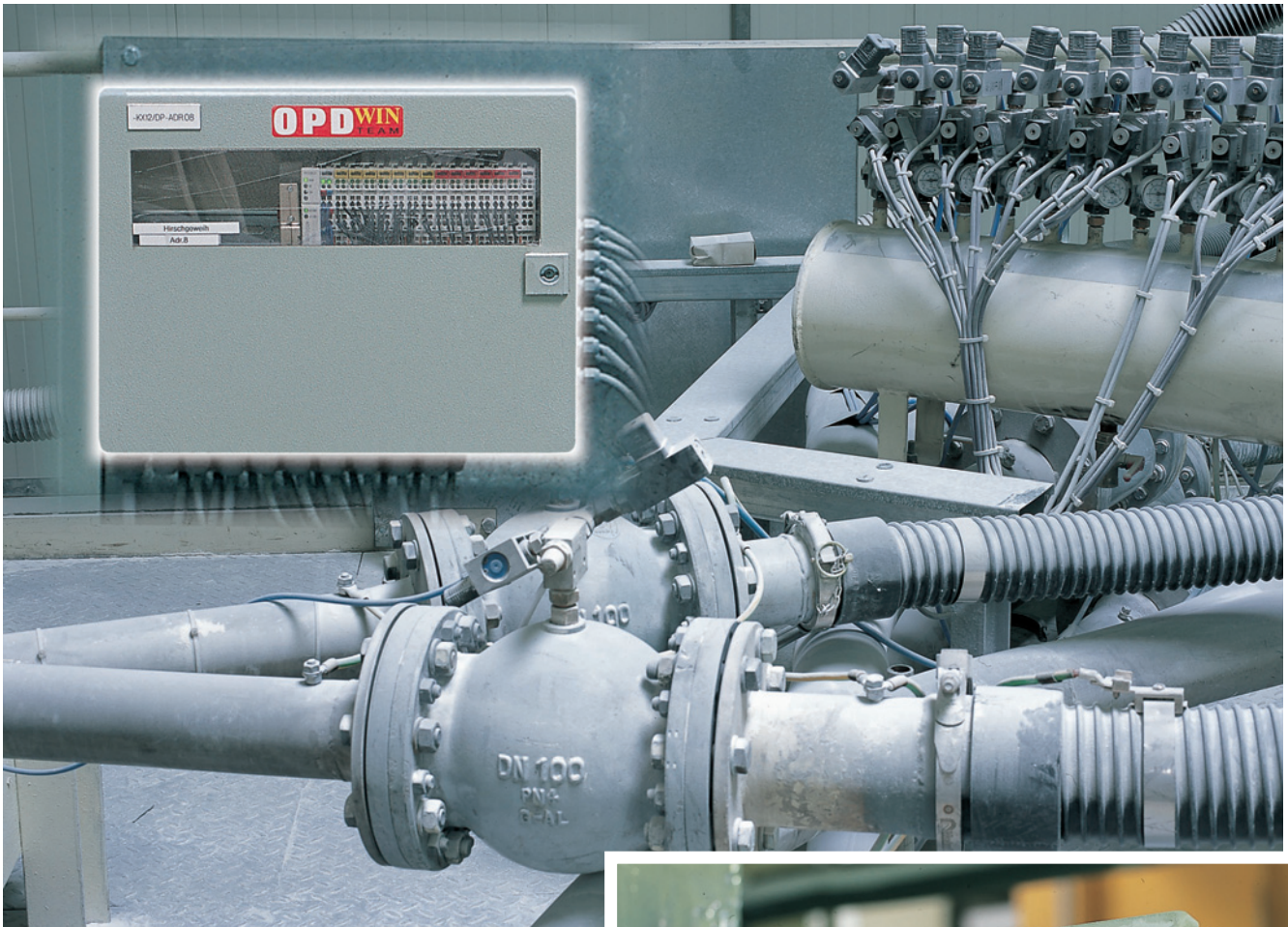

**WAGO Application: Opdenhoff Technologie GmbH
in Hennef, Germany**

Control Systems for Weighing, Mixing and
Conveyance of Bulk Material and Liquids

WAGO Products:
WAGO-I/O-SYSTEM with PROFIBUS Couplers,
Rail-Mounted Terminal Blocks

9



Technical Support	334 - 335
CE Marking and EC Directives	336
General Technical Information for Electrical Equipment in Hazardous Environments	337
Electromagnetic Compatibility and Mechanical Strength (Industrial- and Residential Areas)	338
Electromagnetic Compatibility and Mechanical Strength (Ship Building Area)	339
Specifications and Test Results	340 - 343
WAGO Online, eBooks, DVD <i>AUTOMATON</i>	344 - 345
WAGO Seminars	346 - 347
Index	348 - 353
Item Number Index	354 - 359
WAGO Worldwide – Companies and Representatives	360 - 361

Product Support From

Consulting Services

- Selection of the fieldbus
- Use of components
- Combination of components
- Cooperation with other suppliers



- Contact:
Your national WAGO company
or distributor.

The Very Beginning...

Experienced

- Trained staff
- PLC & PC control
- Multiple fieldbuses
- Programming languages
- Projects:

Automotive industry
Machine building
Chemical industry
Food processing
Building automation
Process engineering
Process control
and many more



We will help you

- Product documentation
- Manuals
- Application notes
- By telephone
- On-site



CE conformity marking:

The CE conformity marking consists of the characters "CE", with the following script:

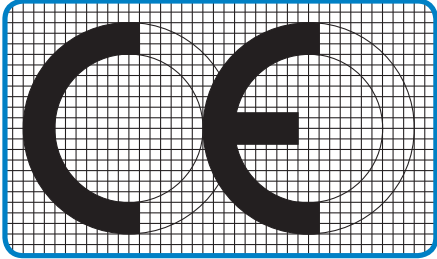

Communauté Européenne (European Community)

The CE marking shall be affixed to the electrical equipment, or if that is not possible, to the smallest packing unit. With the CE marking, manufacturers attest conformity of their products to the relevant directives.

In addition to the CE marking, the manufacturer provides an EC "Declaration of Conformity" for the product. This EC "Declaration of Conformity" must be retained and submitted to a national surveillance authority upon request. EC directives are binding legal regulations of the European Community. Their goal is the harmonization of legal and administrative regulations in the various EC member states, in order to prevent trade obstructions due to different national regulations.

In order to "market" a product, it must comply with the relevant directives. The product may be subject to several directives, e.g. the EMC and the low voltage directives.

The **EC directives** are legally binding specifications of the European Union. Their aim is the alignment of legal and administrative specifications in the various EC member states, in order to prevent trading hindrances arising from different national specifications.

In order to launch a product on the market it has to comply with the relevant directives. Several directives may apply to a product, for example the EMC and the low voltage directives.

2006/95/EC**– Low Voltage Directive**

The safety of electrical equipment is guaranteed by the Low Voltage Directive. This directive covers 'complete' electrical equipment designed for use with a voltage rating of between 50 and 1000V for alternating current and between 75 and 1500V for direct current. Products falling within the scope of the Low Voltage Directive that are designed in such a way that they can be used in other electrical devices and whose safety, for the most part, is dependant on how these components were built into the end product and what features the end product has are defined as basic components in accordance with the Low Voltage Directive.* The Low Voltage Directive doesn't apply to basic components.

2004/108/EC**– EMC Directive**

The EMC Directive implies that a product must meet the limits of the radiated electromagnetic disturbance and also requires that a product must be immune to electromagnetic interference. Electromagnetic passive components or components with no direct function, like resistors, diodes, capacitors, switching relays or cables (in the form of passive printed circuit boards) are not considered as apparatus within the meaning of the EMC Directive.

Machinery Directive

The Machinery Directive does not apply to WAGO products.

94/9/EC Ex Protection Directive, ATEX 100a

General technical information for electrical equipment in hazardous environments.

General Technical Information for Electrical Equipment in Hazardous Environments

Hazardous Environments

Hazardous environments are areas in which the atmosphere may become explosive. Explosive atmosphere is defined as a mixture of ignitable substances in the form of gases,

vapors or mixtures with air under atmospheric conditions in critically mixed ratios such that excessive high temperature, arcs or sparks may cause an explosion.

DIN EN 1127-1 and all other related standards that are commonly known divide up hazardous areas according to the likelihood of the occurrence of an explosive atmosphere into the following zones:

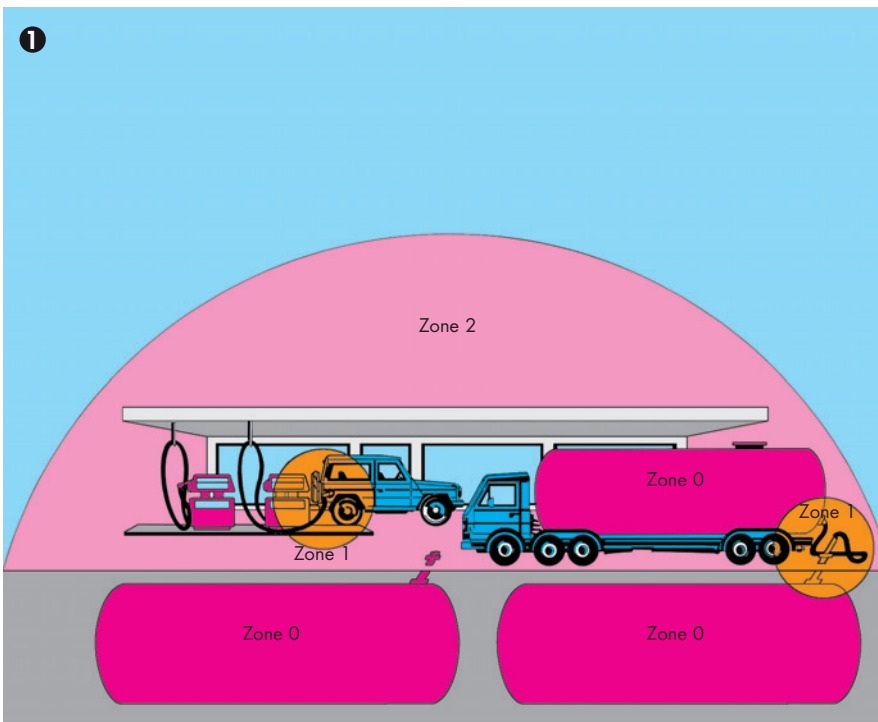

❶ Hazardous environments as a result of combustible gases, vapors or mist.

Zone 0:

Area in which an explosive gas/air mixture is continuously present or present for long periods.

Zone 1:

Area in which an explosive atmosphere can occur during normal operation.

Zone 2:

Area in which an explosive atmosphere is unlikely to occur under normal operation and if it does it will be for a short period.

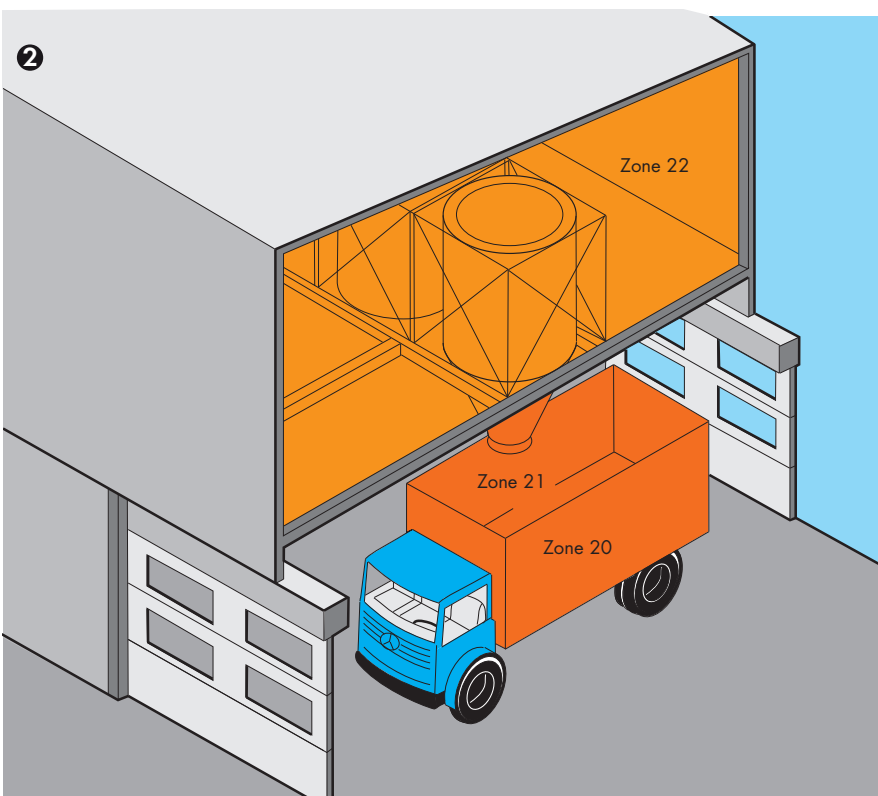

❷ Hazardous areas caused by combustible dust

Zone 20:

Area in which an explosive dusty atmosphere is present "permanently", for "long periods" or "frequently" and in which deposits of combustible dust of unknown or excessive thickness may be formed. Dust deposits alone are not grounds for classification as Zone 20.

Zone 21:

Area in which an explosive dusty atmosphere is present "occasionally" under normal operating conditions and in which deposits or layers of combustible dust can generally be present.

Zone 22:

Area in which an explosive dusty atmosphere is not likely to occur during normal operation and, if it occurs, will only exist for a "short period", or in which accumulations or layers of combustible dust are present.

Please refer to the manuals for more information on explosion protection.

Electromagnetic Compatibility and Mechanical Strength (Industrial and Residential Areas)

Immunity to interference for industrial areas acc. to EN 61000-6-2 (2005)

Test Specification		Test Values	Evaluation Criteria *)
EN 61000-4-2	ESD	4 kV/8 kV (contact/air)	B
EN 61000-4-3	electromagnetic fields	10 V/m: 80 MHz ... 1 GHz	A
		3V/m: 1.4 GHz ... 2.0 GHz	A
		1V/m: 2.0 GHz ... 2.7 GHz	A
EN 61000-4-4	burst	1 kV/2 kV (data/supply)	B
EN 61000-4-5	surge	Data: - / 1 kV (line : line / line : earth)	B
		DC supply: 0.5 kV / 0.5 kV (line : line / line : earth)	B
		AC supply: 1 kV / 2 kV (line : line / line : earth)	B
EN 61000-4-6	RF disturbances	10 V/m 80 % AM (0.15 MHz ... 80 MHz)	A
EN 61000-4-8	Magnetic field	30 A/m 50/60Hz	A
*) Criteria A: The device must work in accordance with the regulations during and after the test. Criteria B: The device must work in accordance with the regulations after the test.			

Emission of interference for residential areas acc. to EN 61000-6-3 (2007)

Test Specification		Limit Values/ Quasi Peak	Frequency Range	Distance
EN 55016-2-1	AC supply, conducted	66 ... 56 dB(μV)	150 kHz ... 500 kHz	
EN 55016-1-2		56 dB(μV)	500 kHz ... 5 MHz	
		60 dB(μV)	5 MHz ... 30 MHz	
EN 55016-2-1	DC supply/	79 dB(μV)	150 kHz ... 500 kHz	
EN 55016-1-2	data, conducted	73 dB(μV)	500 kHz ... 30 MHz	
EN 55016-2-3	radiated	30 dB(μV/m)	30 MHz ... 230 MHz	10 m
		37 dB(μV/m)	230 MHz ... 1 GHz	10 m
EN 55022	Telecommunications/	84 ... 74 dB(μV)	150 kHz ... 500 kHz	
	Mains connection	74 dB(μV)	500 kHz ... 30 MHz	

Emission of interference for industrial areas acc. to EN 61000-6-4 (2007)

Test Specification		Limit Values/ Quasi Peak	Frequency Range	Distance
EN 55016-2-1	AC supply, conducted	79 dB(μV)	150 kHz ... 500 kHz	
EN 55016-1-2		73 dB(μV)	500 kHz ... 30 MHz	
EN 55016-2-3	radiated	40 dB(μV/m)	30 MHz ... 230 MHz	10 m
		47 dB(μV/m)	230 MHz ... 1 GHz	10 m
EN 55022	Telecommunications/	97 ... 87 dB(μV)	150 kHz ... 500 kHz	
	Mains connection	87 dB(μV)	500 kHz ... 30 MHz	

Mechanical strength acc. to IEC 61131-2 (2007)

Test Specification	Frequency Range	Limit Values
IEC 60068-2-6 vibration	5 Hz ≤ f < 9 Hz	1.75 mm amplitude (permanent)
		3.5 mm amplitude (short term)
	9 Hz ≤ f < 150 Hz	0.5 g (permanent)
		1 g (short term)
	Note on vibration test:	
a) Frequency change: max. 1 octave/minute		
b) Vibration direction: 3 axes		
IEC 60068-2-27 shock		15 g
	Note on shock test:	
	a) Type of shock: half sine	
	b) Shock duration: 11 ms	
	c) Shock direction: 3x in positive and 3x in negative direction for each of the three mutually perpendicular axes of the test specimen	

Electromagnetic Compatibility and Mechanical Strength (Ship Building Area)

Immunity to interference acc. to Germanischer Lloyd (2003)

Test Specification		Test Values	Evaluation Criteria *)
IEC 61000-4-2	ESD	6 kV/8 kV (contact/air)	B
IEC 61000-4-3	electromagnetic fields	10 V/m 80 MHz ... 2 GHz	A
IEC 61000-4-4	burst	1 kV /2 kV (data/supply)	A
IEC 61000-4-5	surge, DC supply	0,5 kV /1 kV (line : line / line : earth)	A
	surge, AC supply	0,5 kV /1 kV (line : line / line : earth)	A
IEC 61000-4-6	RF disturbances	10 V 80 % AM (0.15 ... 80 MHz)	A
Type Test	AF disturbances (harmonic waves)	3 V, 2 W	A
Type Test	high voltage	755 V DC	-
		1500 V AC	-
*) Criteria A: The device must work in accordance with the regulations during and after the test.			
Criteria B: The device must work in accordance with the regulations after the test.			

Emission of interference acc. to Germanischer Lloyd (2003)

Test Specification	Limit Values/ Quasi Peak	Frequency Range	Distance
Type Test EMC 1, conducted (allows for ship bridge control applications)	96 ... 50 dB(µV)	10 kHz ... 150 kHz	
	60 ... 50 dB(µV)	150 kHz ... 350 kHz	
	50 dB(µV)	350 kHz ... 30 MHz	
Type Test EMC 1, radiated (allows for ship bridge control applications) except for:	80 ... 52 dB(µV/m)	150 kHz ... 300 kHz	3 m
	52 ... 34 dB(µV/m)	300 kHz ... 30 MHz	3 m
	54 dB(µV/m)	30 MHz ... 2 GHz	3 m
	24 dB(µV/m)	156 MHz ... 165 MHz	3 m
Type Test EMC 2, conducted (allows for machine room applications)	120 ... 69 dB(µV)	10 kHz ... 150 kHz	
	79 dB(µV)	150 kHz ... 350 kHz	
	73 dB(µV)	350 kHz ... 30 MHz	
Type Test EMC 2, radiated (allows for machine room applications) except for:	80 ... 50 dB(µV/m)	150 kHz ... 30 MHz	3 m
	60 ... 54 dB(µV/m)	30 MHz ... 100 MHz	3 m
	54 dB(µV/m)	100 MHz ... 2 GHz	3 m
	24 dB(µV/m)	156 MHz ... 165 MHz	3 m

Mechanical strength acc. to Germanischer Lloyd (2003)

Test Specification	Frequency Range	Limit Values
IEC 60068-2-6 vibration (category A, C)	$2 \text{ Hz} \leq f < 13,2 \text{ Hz}$	±1.0 mm Amplitude (permanent)
	$13.2 \text{ Hz} \leq f < 100 \text{ Hz}$	0.7 g (permanent)
	Note on vibration test: a) Frequency change: max. 1 octave/minute b) Vibration direction: 3 axes	
IEC 60068-2-6 vibration (category A-D)	$2 \text{ Hz} \leq f < 25 \text{ Hz}$	±1.6 mm Amplitude (permanent)
	$25 \text{ Hz} \leq f < 100 \text{ Hz}$	4 g (permanent)
	Note on vibration test: a) Frequency change: max. 1 octave/minute b) Vibration direction: 3 axes	

In particular the following standards apply to the design and the application of the terminal blocks and connectors contained in this catalog:

DIN VDE 0100:1982-11 Construction of high current installations with nominal voltages up to 1000V	IEC 60529:1989 + A1:1999 EN 60529:1991 + A1:2000 VDE 0470-1:2000-09 Degrees of protection provided by enclosures (IP code)	IEC 60998-2-2:2002, modified EN 60998-2-2:2004 VDE 0613-2-2:2005-03 Connecting devices for low-voltage circuits for household and similar purposes - Part 2-2: Particular requirements for connecting devices as separate entities with screwless-type clamping units
EN 50110-1:2004 VDE 0105-1:2005-06 Operation of electrical installations	IEC 60603-1:1991 + A1:1992 EN 60603-1:1998 Connectors for frequencies below 3 MHz for use with printed boards - Part 1: Generic specification: General requirements and guide for the preparation of detail specifications, with assessed quality	IEC 60947-1:2007 EN 60947-1:2007 VDE 0660-100:2008-04 Low-voltage switchgear and controlgear - Part 1: General rules
IEC 61140:2001/A1:2004 (modified) EN 61140:2002/A1:2006 VDE 0140-1:2007-03 Protection against electric shock - Common aspects for installation and equipment	IEC 61984:2001 EN 61984:2001 VDE 0627:2002-09 Connectors - Safety requirements and tests	IEC 60947-5-6:1999 EN 60947-5-6:2000 VDE 0660-212:2000-12 Low-voltage switchgear and controlgear - Part 5-6: Control circuit devices and switching elements, DC interface for proximity sensors and switching amplifiers (NAMUR)
IEC 60664-1:2007 EN 60664-1:2007 VDE 0110-1:2008-01 Insulation coordination for equipment within low-voltage systems - Part 1: Principles, requirements and tests	IEC 60999-1:1999 EN 60999-1:2000 VDE 0609-1:2000-12 Connecting devices - Electrical copper conductors; Safety requirements for screw-type and screwless-type clamping units - Part 1: General requirements and particular requirements for clamping units for conductors 0.2 mm ² up to 35 mm ²	IEC 60439-1:1999 + A1:2004 EN 60439-1:1999 + A1:2004 VDE 0660-500:2005-01 Low-voltage switchgear and controlgear assemblies - Part 1: Type-tested and partially type-tested assemblies
IEC 60204-1:2005 (modified) EN 60204-1:2006 VDE 0113-1:2007-06 Safety of machinery - Electrical equipment of machines - Part 1: General requirements	IEC 60617-2:1996 EN 60617-2:1996 Graphical symbols for diagrams - Part 2: Symbol elements, qualifying symbols and other symbols having general application	IEC 60555-1:1982 - 1st edition EN 60555 part 1, edition 1987 VDE 0838-1:1987-06 Disturbances in supply systems caused by household appliances and similar electrical equipment; part 1: definitions
EN 50178:1997 VDE 0160:1998-04 Electronic equipment for use in power installations	IEC 61558-1:2005 EN 61558-1:2005 VDE 0570-1:2006-07 Safety of power transformers, power supplies, reactors and similar products - Part 1: General requirements and tests	IEC 60715:1981 + A1:1995 EN 60715:2001 Dimensions of low-voltage switchgear and controlgear - Standardized mounting on rails for mechanical support of electrical devices in switchgear and controlgear installations
IEC 62305-1:2006 EN 62305-1:2006 VDE 0185-305-1:2006-10 Protection against lightning - Part 1: General principles	IEC 60669-2-1:2002 EN 60669-2-1:2004 VDE 0632-2-1:2005-08 Switches for household and similar fixed electrical installations - Part 2-1: Particular requirements - Electronic switches	IEC 60950-1:2005, modified EN 60950-1:2006 VDE 0805-1:2006-11 Information technology equipment - Safety - Part 1: General requirements
IEC 60060-1:1989 + corrigendum March 1990 HD 588.1 S1:1991 VDE 0432-1:1994-06 High voltage test techniques; part 1: general specifications and test requirements	IEC 60947-7-1:2002 + Corrigendum 1:2003 EN 60947-7-1:2002 VDE 0611-1:2003-07 Low-voltage switchgear and controlgear - Part 7-1: Ancillary equipment - Terminal blocks for copper conductors	IEC 60127-6:1994 + A1:1996 + A2:2002 EN 60127-6:1994 + A1:1996 + A2:2003 VDE 0820-6:2003-10 Miniature fuses - Part 6: Fuse-holders for miniature fuse-links
IEC 60085:2007 EN 60085:2008 VDE 0301-1:2008-08 Electrical insulation - Thermal evaluation and designation		

- EN 50155:2007
VDE 0115-200:2008-03
Railway applications - Electronic equipment used on rolling stock
- EN 50090-2-2:1996 + Corrigendum:1997 + A1:2002 + A2:2007
VDE 0829-2-2:2007-11
Home and Building Electronic Systems (HBES) - Part 2-2: System overview - General technical requirements; German version
- IEC 60099-1:1991 + A1:1999
EN 60099-1:1994 + A1:1999
VDE 0675-1:2000-08
Surge arresters - Part 1: Non-linear resistor type gapped surge arresters for a.c. systems
- IEC 61643-1:1998 + Corrigendum 1998, modified
EN 61643-11:2002 + A11:2007
VDE 0675-6-11:2007-08
Low-voltage surge protective devices - Part 11: Surge protective devices connected to low-voltage power systems - Requirements and tests
- IEC 61643-21:2000 + Corrigendum: 2001
EN 61643-21:2001
VDE 0845-3-1:2002-03
Low voltage surge protective devices - Part 21: Surge protective devices connected to telecommunications and signalling networks; Performance requirements and testing methods
- IEC 61508-1:1998 + Corrigendum 1999
EN 61508-1:2001
VDE 0803-1:2002-11
Functional safety of electrical/electronic/programmable electronic safety-related systems - Part 1: General requirements
- IEC 62061:2005
EN 62061:2005
VDE 0113-50:2005-10
Safety of machinery - Functional safety of safety-related electrical, electronic and programmable electronic control systems
- Interfaces - Fieldbuses**
- DIN 66259-1:1981-05
Electrical characteristics for unbalanced double-current interchange circuits
- EN 50325-1:2002
Industrial communications subsystem based on ISO 11898 (CAN) for controller-device interfaces - Part 1: General requirements
- IEC 61784-1:2007
EN 61784-1:2008
Industrial communication networks - Profiles - Part 1: Fieldbus profiles
- IEC 61158-2:2007
EN 61158-2:2008
Industrial communication networks - Fieldbus specifications - Part 2: Physical layer specification and service definition
- IEC 61158-6-x
EN 61158-6-x
DIN EN 61158-6-x
Industrial communication networks - Fieldbus specifications - Part 6-x
- Explosion Protection**
- IEC 60079-0:2004, modified
EN 60079-0:2006
VDE 0170-1:2007-05
Explosive atmospheres - Part 0: General requirements
- IEC 60079-7:2006
EN 60079-7:2007
VDE 0170-6:2007-08
Explosive atmospheres - Part 7: Equipment protection by increased safety "e"
- IEC 60079-11:2006
EN 60079-11:2007
VDE 0170-7:2007-08
Explosive atmospheres - Part 11: Equipment protection by intrinsic safety "i"
- IEC 60079-14:2007
EN 60079-14:2008
VDE 0165-1:2009-05
Explosive atmospheres - Part 14: Electrical installations design, selection and erection
- IEC 60079-15:2005
EN 60079-15:2005
VDE 0170-16:2006-05
Electrical apparatus for explosive gas atmospheres - Part 15: Construction, test and marking of type of protection "n" electrical apparatus
- IEC 61241-0:2004, modified + Corrigendum Nov. 2005
EN 61241-0:2006
VDE 0170-15-0:2007-07
Electrical apparatus for use in the presence of combustible dust - Part 0: General requirements
- IEC 61241-1:2004
EN 61241-1:2004
VDE 0170-15-1:2005-06
Electrical apparatus for use in the presence of combustible dust - Part 1: Protection by enclosures "tD"
- IEC 61241-11:2005 + Corrigendum February 2006
EN 61241-11:2006
VDE 0170-15-11:2007-07
Electrical apparatus for use in the presence of combustible dust - Part 11: Protection by intrinsic safety "iD"

Specifications and Test Results (continued)

Environmental Testing

IEC 60068-2-6:2007
 EN 60068-2-6:2008
 VDE 0468-2-6:2008-10
 Environmental testing - Part 2-6: Tests -
 Test Fc: Vibration (sinusoidal)

IEC 60068-2-27:1987
 EN 60068-2-27:1993
 Basic environmental testing procedures -
 Part 2: Tests; test Ea and guidance: Shock

IEC 60068-2-42:2003
 EN 60068-2-42:2003
 Environmental testing - Part 2-42: Tests -
 Test Kc: Sulphur dioxide test for contacts
 and connections

IEC 60068-2-43:2003
 EN 60068-2-43:2003
 Environmental testing - Part 2-43: Tests -
 Test Kd: Hydrogen sulphide test for contacts
 and connections

EMC Requirements

IEC 61000-6-1:2005
 EN 61000-6-1:2007
 VDE 0839-6-1:2007-10
 Electromagnetic compatibility (EMC) -
 Part 6-1: Generic standards - Immunity for
 residential, commercial and light-industrial
 environments

IEC 61000-6-2:2005
 EN 61000-6-2:2005
 VDE 0839-6-2:2006-03
 Electromagnetic compatibility (EMC) -
 Part 6-2: Generic standards - Immunity for
 industrial environments

IEC 61000-6-3:2006
 EN 61000-6-3:2007
 VDE 0839-6-3:2007-09
 Electromagnetic compatibility (EMC) -
 Part 6-3: Generic standards - Emission
 standard for residential, commercial and
 light-industrial environments

IEC 61000-6-4:2006
 EN 61000-6-4:2007
 VDE 0839-6-4:2007-09
 Electromagnetic compatibility (EMC) -
 Part 6-4: Generic standards - Emission
 standard for industrial environments

IEC 61000-3-2:2005
 EN 61000-3-2:2006
 VDE 0838-2:2006-10
 Electromagnetic compatibility (EMC) -
 Part 3-2: Limits - Limits for harmonic current
 emissions (equipment input current ≤ 16 A
 per phase)

IEC/CISPR 11:2003 + A1:2004,
 modified + A2:2006
 EN 55011:2007 + A2:2007
 VDE 0875-11:2007-11
 Industrial scientific and medical (ISM) radio-
 frequency equipment -
 Electromagnetic disturbance characteristics -
 Limits and methods of measurement

IEC/CISPR 22:2005, modified + A1:2005
 EN 55022:2006 + A1:2007
 VDE 0878-22:2008-05
 Information technology equipment - Radio
 disturbance characteristics - Limits and
 methods of measurement

IEC/CISPR 24:1997, modified + A1:2001
 + A2:2002
 EN 55024:1998 + A1:2001 + A2:2003
 VDE 0878-24:2003-10
 Information technology equipment -
 Immunity characteristics - Limits and
 methods of measurement

IEC 61326-3-1:2008
 EN 61326-3-1:2008
 VDE 0843-20-3-1:2008-11
 Electrical equipment for measurement,
 control and laboratory use - EMC
 requirements - Part 3-1: Immunity
 requirements for safety-related systems and
 for equipment intended to perform
 safety-related functions (functional safety) -
 General industrial applications

PLC

IEC 61131-1:2003
EN 61131-1:2003
Programmable controllers -
Part 1: General information

IEC 61131-2:2007
EN 61131-2:2007
VDE 0411-500:2008-04
Programmable controllers -
Part 2: Equipment requirements and tests

IEC 61131-3:2003
EN 61131-3:2003
Programmable controllers -
Part 3: Programming languages

Relays

IEC 61810-1:2008
EN 61810-1:2008
VDE 0435-201:2009-02
Electromechanical elementary relays -
Part 1: General requirements

IEC 61810-2:2005
EN 61810-2:2005
VDE 0435-120:2006-01
Electromechanical elementary relays -
Part 2: Reliability

IEC 61810-5:1998
EN 50205:2002
VDE 0435-2022:2003-01
Electromechanical non-specified time
all-or-nothing relays - Part 5: Insulation
coordination

IEC 60255-5:2000
EN 60255-5:2001
VDE 0435-130:2001-12
Electrical relays - Part 5: Insulation
coordination for measuring relays and
protection equipment - Requirements and
tests

UL Directives

UL 1059; ANSI 1059:2001-12
Terminal blocks

UL 486E:2009-05
Equipment wiring terminals for use with
aluminum and/or copper conductors

UL 508:1999-01
Industrial control equipment

ANSI/ISA 12.12.01:2007
Nonincendive electrical equipment for use
in Class I and Class II, Division 2 and Class
III, Divisions 1 and 2 hazardous (classified)
locations

Ship Classifications

ABS (American Bureau of Shipping)
Steel Vessels 2008
Part 4: Vessel Systems and Machinery

BV (Bureau Veritas)
Rules for the classification of steel ships and
offshore units

DNV (Det Norsk Veritas)
Det Norsk Veritas' Rules for Classification of
Ships, High Speed & Light Craft and
Det Norsk Veritas' Offshore Standards:
2007

GL (Germanischer Lloyd) 2003
Rules for Classification and Construction
VI Additional Rules and Guidelines
7 Guidelines for the Performance of Type
Test
2 Test Requirements for Electrical/Electronic
Devices and Systems

LR (Lloyds Register) 2002
Type Approval System
Test Specification Number 1-1996

RINA (Registro Italiano Navale)
Rules for the classification of ships
Part C - Machinery, systems and fire
protection Ch.3, Sect.6, Table 1
Edition 2008

BSH (Federal Maritime and Hydrographic
Agency) 2005
Certificate on measurement of safe distance
to the standard magnetic and steering
magnetic compass in accordance with ISO
R 695 and DIN EN 60945 Section 11.2

KR (Korean Register of Shipping)
List of Approved Manufacturers and Type
Approved Equipment; Pt. 6, Ch. 1, Sec. 3 of
the Rules for Classification of Steel Ships

NKK (Nippon Kaiji Kyokai) Edition 2009
Guidance for the Approval and Type
Approval of Materials and Equipment for
Marine Use

PRS (Polski Rejestr Statkow) 2002
Publication No. 11/P
Environmental Tests on Marine Equipment

WAGO online

Keep up-to-date.
Visit us online!

You want to get informed on our products quickly and conveniently?
You want more information on our company? No problem!
At www.wago.com you will find a wealth of information on WAGO:

- Information on our company
- The latest product news
- The newest manuals, data sheets, brochures and flyers in different formats
- Dates for the next seminars, information events, roadshows, trade fairs and much more...



www.wago.com

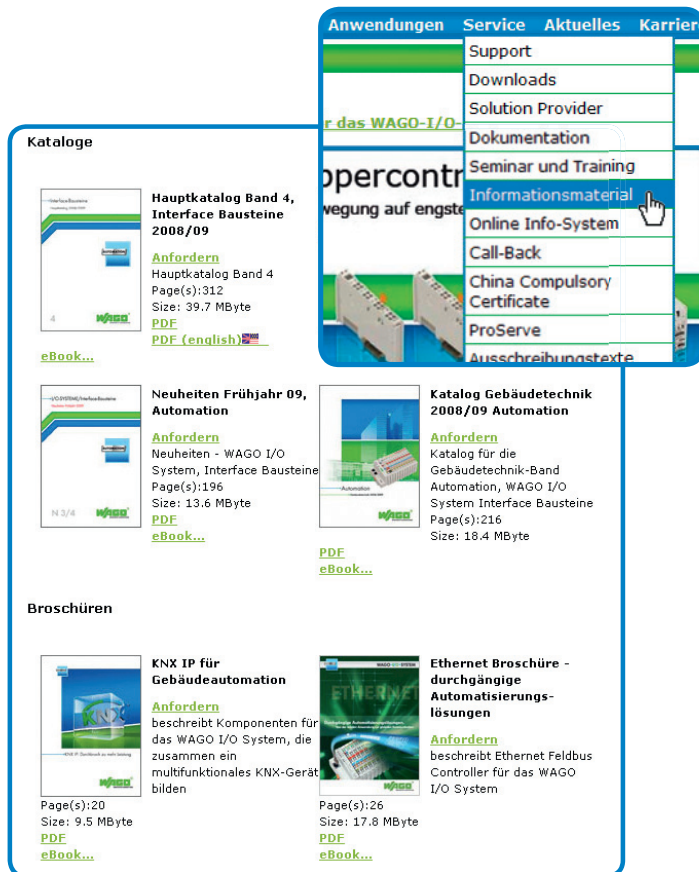

We are continuously working on improving the service section of our website. In addition to product documentation and information resources (in both PDF and ebook format), software downloads are also available from this section.

If you have any questions on a particular topic, please use our call-back service and we will call you back whenever it is convenient for you.

Keep up-to-date. Visit us online!

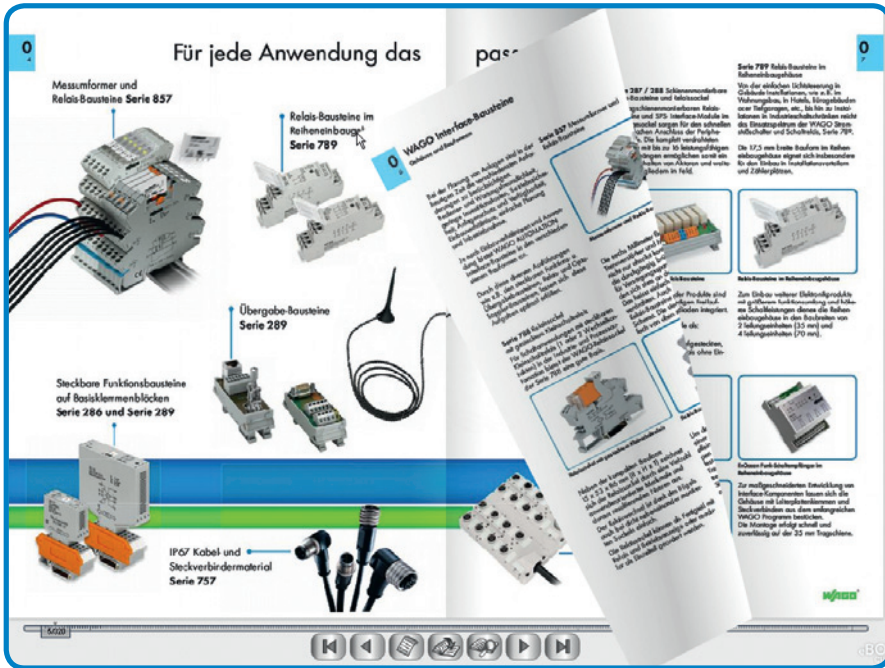

In the service section of our website, you will find the latest product catalogs and brochures as interactive eBooks. A search and zoom function allows you to quickly find exactly what you are looking for. The dynamic content makes "leafing" through the pages much easier; and if you prefer a hardcopy, simply print out the pages you want to read.

DVD **AUTOMATION** Tools and Docs

In addition to the latest technical documentation, this DVD-ROM also contains our AUTOMATION product catalogs and brochures as interactive eBooks.

The technical documentation includes short descriptions, application notes, data sheets and manuals for all our AUTOMATION products.

Specific information resources on our electronic components can be viewed in PDF format. If you are reluctant to leaf through massive catalogs, you can also browse all AUTOMATION catalogs und brochures as eBooks, of course, with search or keyword function.

In addition, all WAGO-I/O-SYSTEM software products (which can also be found on our website) can be directly installed from the DVD-ROM.

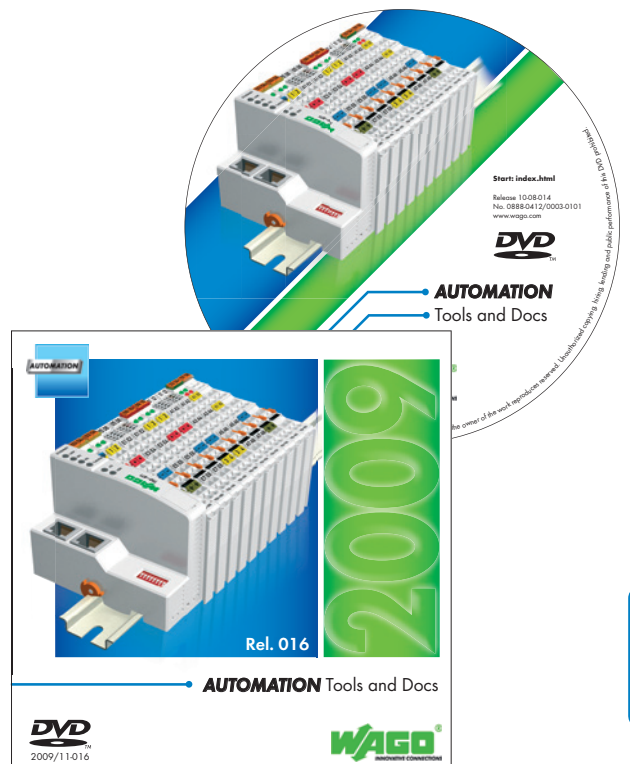

WAGO Seminars

Knowledge directly from the source



WAGO develops and produces products while keeping in mind innovative ideas and advanced technology.

The most efficient use of our products is achieved through optimal application knowledge. For this reason, WAGO conveys this knowledge in effective and user-oriented seminars. These seminars can save you time and will help you use our products to their fullest capacities.



Your Goals are Used as the Gauge of Our Success.

Product-related and customer-specific training courses



Small groups

No question goes unanswered and no-one is overlooked in WAGO training courses made up of small groups.



Team work

Learning is effective in small groups. Ideas can be discussed, exchanged, and experiences can be shared - all for the benefit of the attendees.

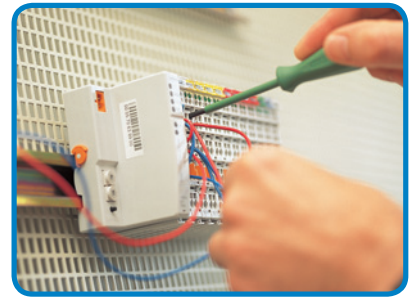

Practical

Experience tells us: Practice makes perfect! Hands-on applications are highly emphasized in WAGO seminars.

**WAGO Seminars - this means:
information from the source. It doesn't get
more direct.**

Your instructor is trained 100% on each subject. They have learned from their own experience. Your time will not be wasted. Each minute at a WAGO seminar is an investment in your knowledge.

Request your registration form by e-mail:

training@wago.com

Contact us so that our seminars can be adapted to your requirements.

++49 (0) 571 /887-327

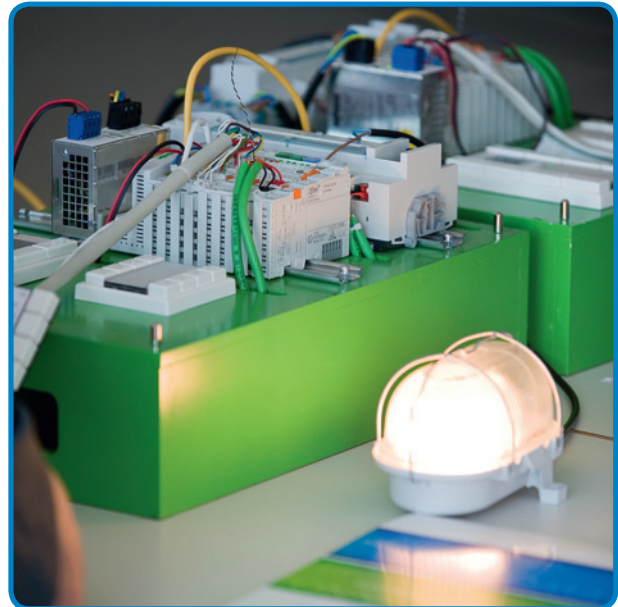

Product-related courses

We offer product-related training courses on the following topics at regular intervals:

- Building and industrial automation
- Programming of automation components
- Fieldbus systems

For current course dates go to:
www.wago.com/seminare

Customer-specific training courses

In addition to these "open" training courses, we also offer customer-specific courses as company courses to address your company's particular needs.

On request, we can also conduct these courses at your company.

Special company courses

	Catalog Catalog (Page)		Catalog Catalog (Page)		Catalog Catalog (Page)
A					
Actuator and actuator LED terminal blocks		Cables, pre-assembled		DALI/DSI master module	3
rail-mounted terminal blocks	1	WINSTA® RD	5	Data exchange coupler	3
Actuator cables	3	WINSTA® KNX	5	Data exchange module	3
Additional modules for matrix patchboards	1	CAGE CLAMP® connection	4 (2), 1, 2, 3	DC drive controller	3
Addressing tool	3	CAGE CLAMP®S connection	4 (2), 1, 2, 3, 5	DC/DC converter	
Analog input modules	3	CAL® fieldbus components	3	Rail-mounted terminal block	4 (264 - 265)
Analog input modules	3	CANopen® fieldbus components	3	DIN-rail-mountable	4 (266)
Analog output modules	3	Carrier rails	4 (326), 1, 3	Decade marker carrier	1
Analog output modules	3	CC-Link fieldbus connector	3	Decentralized building automation	3
Analog signal conditioning modules		CC-Link fieldbus coupler	3	Derating curves	
-pluggable	4 (230 - 232)	CE marking	4 (336), 1, 2, 3	see current-carrying capacity curves	
Analog signal conditioning modules	4 (230 - 232)	Changeover rocker switch		MULTI CONNECTION SYSTEM	2
AND gate modules		Coding keys	2	Device connectors	
-pluggable	4 (134)	Coding pin, WINSTA®	5	-WINSTA® MINI	5
Angled female connectors		Coding, WINSTA®	5	-WINSTA® MIDI	5
see "MULTI CONNECTION SYSTEM", 100%		Collective carrier for jumper	1	DeviceNet® fieldbus components	3 (Section 1, 6, 7)
protected against mismatching, classic/standard		Combi PCB terminal blocks	2	Differential inputs and differential measurement	
version	2	Combi strips	2	inputs	
Angled support brackets	1, 3	Combi-style jumper bars	1, 2	see "Analog input modules"	3
Antenna (SMA plug)	4 (290)	Commissioning software	4 (220), 3	Digital impulse interface	3
Approvals	4 (340 - 343), 1, 2, 3	Common potential matrix patchboards	1	Digital input modules	3
Approvals for WAGO-I/O-SYSTEM	3	Commoning strips for PCB terminal blocks	2	Digital input modules	3
AS-Interface master module	3	Compact block terminal blocks	1	Digital output modules	3
AS-Interface switch mode power supply	4 (245), 3	Compact connector for flexible conductors	1	Digital output modules	3
B					
Back-up capacitor module	4 (254), 3	Compact terminal blocks	1	DIN-rail mount enclosures	
BACnet configurator	3	Compact terminal blockssee "Miniature		Diode gate modules	
BACnet controller	3	(rail-mounted) terminal blocks"		DIN-rail-mountable	4 (186 - 187)
Banana plugs	1	Companies and representations WAGO worldwide	4 (362 - 363), 1, 2, 3, 5	-pluggable	4 (133)
Base terminal blocks, f.-e.		Computer marking	4 (310 - 322), 1, 3	Diode modules, for carrier or through terminal	
-double-deck, triple-deck terminal blocks	1	Condition monitoring	3	blocks, pluggable	1
X-COM®-SYSTEM	1	Configuration cable	4 (221), 3	Diode terminal blocks, f.-e.	1
X-COM®S-SYSTEM	1	Configuration files	3	TOPJOB®S	1
Binary spacer module	3	Connecting cable	3	Diode terminal blocks, f.-e. - double-deck terminal	
Bipolar isolation amplifier	4 (198)	Connecting system, 10- or 20-pole	2	blocks	1
Bistable relays		Connection cable	3	Diode terminal blocks, f.-e. - triple-deck terminal	
DIN-rail-mountable	4 (95)	Connection modules	4 (184 - 185)	blocks	1
-pluggable	4 (109)	sensors	4 (184)	TOPJOB®S	1
Block I/O SYSTEM	3	actuators	4 (185)	Direct printing	
Bluetooth I/O module	3	Connection of aluminum wires	1	-MICRO	2
Bridge rectifiers	4 (130 - 131)	Connectors		-MINI	2
Building automation	3	-wire-tap branch; 3- and 6-pole (elevator shaft		-MIDI	2
Bus coupler units for EIB applications	2	technology)	2	-MAXI	2
Busbar terminal blocks	1	-for EIB applications	2, 5	Disconnect terminal blocks, f.-e.,	
Busbar terminal blocks	1	- 10- or 20-pole connectors for racks	2	angled type	
C					
Cable assemblies		-for PCBs	2, 5	with disconnect link, pivotable fuse holder	1
-WINSTA® MINI	5	-High-current	1	horizontal type	
-WINSTA® MIDI	5	-MULTI CONNECTION SYSTEM	2	Double-deck terminal blocks	1
-WINSTA® RD	5	TOPJOB®S	1	with disconnecting tab	1
-WINSTA® KNX	5	-WINSTA®	5	Disconnect/Test terminal blocks, f.-e.	
Cable assemblies	5	-X-COM®-SYSTEM	1	angled type	1
Cable assembly	3	Connectors for junction boxes	1	(for use with voltage transformer circuits or current	
Cable marking	4 (324 - 325), 3	Connectors, 10- or 20-pole, e.g. for racks		transformer circuits) horizontal type	
Cable stripper	4 (331), 3, 5	Constant voltage sources		with knife disconnect	1
Cables and connectors	3	DIN-rail-mountable	4 (258 - 259), 3	TOPJOB®S	1
Cables and connectors for fieldbus systems	3	Contact paste "Alu Plus"	1, 2	with pivotable disconnect link	1
Cables, pre-assembled		Control panel	3	Disconnect/Test terminal blocks, s.-e.	1
WINSTA® MINI	5	Cover for rail-mounted terminal blocks	1	Distribution box, WINSTA®	5
WINSTA® MIDI	5	Crimping tools for ferrules	1, 2	Distribution cables (sensor/actuator)	3
D					
		CT/VT terminal blocks		Distribution connector, WINSTA®	
		see "Disconnect/Test terminal blocks"		-MINI	5
		Current flow monitoring modules		-MIDI	5
		-pluggable	4 (128 - 129)	-KNX	5
		Current flow monitoring modules - pluggable		Distribution installation terminal blocks	
		-current-carrying capacity curves		see also „Multilevel installation terminal blocks"	
		-PCB terminal blocks	2	Distribution terminal blocks, f.-e.	
		-X-COM®-SYSTEM	1	see TOPJOB® multilevel installation terminal blocks	
		-MULTI CONNECTION SYSTEM		TOPJOB®S	1
				DLL MODBUS®/TCP software	3
				Documentation	4 (344 - 345), 3

Catalog(Page)

1 = Full Line Catalog Volume 1 (Rail-Mounted Terminal Block Systems), 2 = Full Line Catalog Volume 2 (PCB Terminal Blocks and Connectors)

3 = Full Line Catalog Volume 3 (I/O-SYSTEM), 4 = Full Line Catalog Volume 4 (Interface Modules), 5 = Full Line Catalog Volume 5 (WINSTA®)

f.-e. = front-entry, s.-e. = side-entry

	Catalog Catalog (Page)
D	
Double pin headers see MULTI CONNECTION SYSTEM MIDI	
Double potential terminal blocks, f.-e. TOPJOB®S	1 1
for matrix patching	1
Double-deck comb-style jumper bars	
Double-deck headers MULTI CONNECTION SYSTEM	2
TOPJOB®S	1
diode terminal blocks, LED terminal blocks TOPJOB®S	1
Down counter see "Up/down counters"	
D-Sub fieldbus connector	3
DVD "AUTOMATION Tools and Docs"	4 (345), 3
E	
e-Books	4 (345), 3
EC directives	4 (336), 1
EDS files see "Configuration files"	
Electronic modules	
Electronic terminal blocks with pluggable miniature switching relays	
Empty component plug housings for building custom circuits	4 (294 - 295)
Empty component plug housings for rail-mounted terminal blocks	4 (296)
Empty housings	
Rail-mounted terminal block empty housings	4 (297)
Enclosures for WAGO-I/O-SYSTEM 750	3 (338 - 343)
End module	3
End stops	
- for DIN 15 rail	1
- for DIN 35 rail	4 (327), 1, 3
Engraving plotter with engraver	4 (320 - 321), 3
EnOcean radio switching receiver	4 (288), 3
EnOcean radio technology	4 (286 - 287), 3
EnOcean switches	4 (290), 3
EPSITRON®	
PRO power supplies	4 (236 - 239), 3
CLASSIC power supplies	4 (240 - 245), 3
ECO power supplies	4 (246 - 247), 3
Electronic circuit breakers	4 (248 - 249), 3
Uninterruptible power supplies (UPS)	4 (250), 3
Capacitive buffer modules	4 (253), 3
Redundancy module	4 (255), 3
Communication cable RS-232	4 (256), 3
ETHERNET fieldbus connector	3
ETHERNET fieldbus components	3
Ex e II Double potential terminal blocks, f.-e.	1
Ex e II Ground (earth) conductor terminal blocks	1
Ex e II MINI ground (earth) conductor terminal blocks for DIN 15 and DIN 35 rails	1
Ex e II Miniature through terminal blocks, f.-e. for DIN 15 rail and DIN 35 rail	1
Ex e II Modular terminal blocks and terminal strips with fixing flanges or mounting feet	
- f.-e.	1
- s.-e.	1
Ex e II PCB terminal blocks	2
Ex e II Through terminal blocks, f.-e.	
angled type	1
TOPJOB®	1
TOPJOB®S	1
horizontal type	1
TOPJOB®S	1
Double- and triple-deck terminal blocks	1
Ex i Fieldbus modules	3

	Catalog Catalog (Page)
E	
Ex i Terminal blocks see "Through terminal blocks"	
Ex Technical information	4 (337), 1, 3
Extended input voltage and temperature range	4 (48)
F	
Feedthrough pluggable connectors for PCBs see MULTI CONNECTION SYSTEM	2
Feedthrough terminal strips for PCB	2
Female and male connectors see "Connectors, for ex. for racks"	
Female PCB connectors	2
Female PCB terminal blocks	2
Female plugs see MULTI CONNECTION SYSTEM	2
see X-COM®-SYSTEM	1
see X-COM®S-SYSTEM	1
Female sockets for elevator shaft technology	2
Ferrules	4 (81), 1, 2
TOPJOB®S	1
4-conductor chassis-mount terminal strips	1
Field side connection module	3
Field side power supply filter module	3
Fieldbus components	3
Fieldbus connectors	3
Fieldbus controllers	3
Fieldbus couplers	3
Filter modules	2, 3
FIT CLAMP® connection (insulation displacement connection)	1
Fixing adapter for push-wire connectors	
Fixing flange MCS-MIDI 100% protected against mismatching	
- 5 mm	2
- 7.5 mm	2
Fixing flange MCS-MIDI Classic	
- 5/5.08 mm	2
- 7.5/7.62 mm	2
Fixing flange MCS-MINI	
3.5/3.81 mm	2
Flip-Flop module	3
Function blocks for building automation	3
Function modules	4 (0)
Fuse modules	
- for base terminal blocks	1
Fuse modules	1
Fuse terminal blocks, f.-e.	
angled type for mini-automotive fuses	1
with pivotable fuse holder	1
horizontal type, TOPJOB®S	1
with pivotable fuse holder	1
Fuse terminal blocks, s.-e.	1
G	
Gate modules	
- DIN-rail-mountable	4 (186 - 190)
- pluggable	4 (133 - 134)
Ground (earth) conductor disconnect terminal blocks, f.-e.	1
TOPJOB®S	1
Ground (earth) conductor disconnect terminal blocks, s.-e.	1

	Catalog Catalog (Page)
G	
Ground (earth) conductor terminal blocks	
angled type, f.-e.	1
Supply terminal blocks	1
TOPJOB®S (rail-mounted) terminal blocks	1
TOPJOB®S	1
horizontal type, f.-e.	1
5mm wide; 4mm ²	1
Double-deck terminal blocks	1
Triple-deck terminal blocks	1
TOPJOB®S (rail-mounted) terminal blocks	1
Ground (earth) conductor terminal blocks with insulation displacement (FIT CLAMP®) connection	1
Ground (earth) conductor terminal blocks, miniature type for DIN 15 and DIN 35 rails	1
Ground (earth) conductor terminal blocks, s.-e.	1
High-current terminal blocks	1
Group marker carriers	4 (323), 1, 3
TOPJOB®S	1
GSD files see "Configuration files"	
H	
h-distribution connector	
- WINSTA® MINI	5
- WINSTA® MIDI	5
Headers for double deck assembly MULTI CONNECTION SYSTEM	2
High current PCB terminal blocks	2
High-current connectors	1, 2
High-current, rail-mounted terminal blocks with POWER CAGE CLAMP® connection	1
Human Machine Interface	
I	
I/O enclosures	3
I/O modules see WAGO-I/O-SYSTEM	3
I/O modules for severe conditions - WAGO-I/O-SYSTEM 755	3
I/O-SYSTEMS	3
IEC/EN specifications	4 (340 - 343), 1, 2, 3
II/O-LIGHTBUS fieldbus components	3
Incremental encoder interface see "LED gates, LED indicators, LED terminal blocks"	3
Industrial compact PC	3
Industrial PC	3
Industrial relays	4 (82 - 86)
Industrial switches	3
Input voltage range, extended	4 (48, 138)
Insulation displacement (FIT CLAMP®) connection	1
Insulation stop	
for matrix patchboards	1
for rail-mounted terminal boxes	1
Integrated end plate for group formation	
Loss of pin spacing	2
INTERBUS® fieldbus components	3
Interface modules	
- for ETHERNET	4 (180 - 182)
- for ERNI mating connector	
- for Harting mating connector	
- for Siemens SIMATIC	4 (168 - 171)
- for connectors	
- with header	
- with D subminiature connector	4 (152 - 159)

	Catalog Catalog (Page)
I	
Interface modules	4 (Section 2)
Interface modules for sensors and actuators	
Interface software	3
Interference-free in safety functions	3
Intermediate coupler, WINSTA®	
- MIDI	5
Internal data bus extension modules	3
Intruder detection	
see "Digital input modules"	3
IO-Link Master	3
Isolation amplifiers	
Item number index	4 (354 - 359)
J	
Jumpers for rail-mounted terminal blocks	
see push-in type wire jumpers, staggered jumpers, step-down jumpers	
JUMPFLEX®	
Transducers	4 (194 - 219)
Sockets with solid state relay	4 (56 - 62)
Sockets with miniature switching relay	4 (50 - 53)
Junction and distribution connectors, MICRO for EIB applications	2
K	
KAMMRELAIS	4 (98 - 99)
MICRO junction and distribution connectors	
Connectors (bus coupler units)	2
KNX IP controller	3
KNX/EIB/TP1 module	3
L	
Lamp demonstration connector ("Service" connector)	1
Lamp test circuit gate modules	
- DIN-rail-mountable	4 (189)
Latching relays	4 (144)
LED and neon indicators - pluggable	1
LED gate modules	
- DIN-rail-mountable	4 (189)
- pluggable	4 (134)
LED terminal blocks, f.-e.	1
TOPJOB®S	1
LED terminal blocks, f.-e. - double-deck terminal blocks	1
TOPJOB®S	1
LED terminal blocks, f.-e. - triple-deck terminal blocks	1
TOPJOB®S	1
Lighting connectors	1
Lighting connectors	1
Lighting control DALI/DSI	3
Lighting protection	4 (270 - 282)
Linux® controller	3
Locking levers	
- WINSTA® MINI	5
- WINSTA® MIDI	5
Lockout cap, WINSTA®	
- MINI	5
- MIDI	5

	Catalog Catalog (Page)
L	
Lockout caps	2
Longitudinal switching disconnect terminal blocks	1
LONWORKS® fieldbus components	3
M	
Magnetic antenna	4 (290), 3, 5
Male and female connectors	
see "Connectors, for ex. for racks"	
Manual control module	4 (149)
Manuals for fieldbus components	3
Marker branches	1
Marker cards	
WAGO miniature Quick marking system (miniature WSB cards)	4 (323), 3
self-adhesive strips, computer marked	1, 2
WAGO Multi marking system (WMB cards)	4 (323), 1
WAGO WSB Quick marking system (WSB Cards)	4 (323), 1
Marker cards for WAGO group marker carriers	4 (323)
Marker carrier	3
Marker carriers	1
Marker strips for TOPJOB®S	1
Marker strips, self-adhesive	2, 3
Marker tags	1
Marking	4 (323), 1, 2, 3, 5
Marking	4 (323), 1, 2, 3, 5
Marking pen with fiber tip	4 (49), 1, 2, 3
Material specification for insulation materials, contact materials, contact surface	1, 2
Measurement and disconnect terminal blocks	
see "Disconnect terminal blocks for test and measurement"	
MICRO junction and distribution connectors for EIB applications	
MICRO PUSH WIRE® connectors for junction boxes	1, 2
Millivolt transducer	4 (216 - 217)
Miniature ground (earth) conductor terminal blocks, f.e. for DIN 15 and DIN 35 rails	1
Miniature switching relays	4 (32 - 38, 50 - 51)
Miniature through terminal blocks, f.e. for DIN 15 and DIN 35 rails	1
Miniature WSB Quick marking system (marker cards)	4 (323), 3
MODBUS® fieldbus components	3
Modular feedthrough terminal blocks	2
Modular female PCB connectors	2
Modular PCB terminal blocks	
fuse terminal blocks, terminal blocks, terminal blocks for test and measurement	2
f.-e. and s.-e., high-current terminal blocks	2
1-conductor, 2-conductor	2
Modular terminal blocks	
with screw-clamp connection	
Modular terminal blocks and terminal strips	
see terminal strips and modular terminal blocks	
see PCB terminal blocks	
Modular test plug adapters see „Test plug adapters“	
Modular WAGO-I/O-SYSTEM 750	3
Module in DIN-rail mount enclosure	
- Manual control module	4 (149)
- Radio switching receiver	4 (148)
- Switching relay	4 (140 - 145)
- for building custom circuits	4 (298)
Modules for self-assembly	4 (191)

	Catalog Catalog (Page)
M	
Mounting carrier	
Mounting carrier for MULTI CONNECTION SYSTEM	2
Mounting carrier, for isolated mounting on carrier rails	1
Mounting carriers and feet for snap-fit mounting to PCBs	4 (302 - 303)
Mounting carriers for DIN-rail mounting PCBs	4 (300 - 301)
Mounting plates, for WINSTA® distribution connectors	
- MINI	5
- MIDI	5
- IDC	5
MULTI CONNECTION SYSTEM MICRO 100% protected against mismatching, pin spacing	
- 2.5mm	2
- 2.5mm PressIn technique	2
- 2.5mm reflow soldering	2
MULTI CONNECTION SYSTEM MIDI 100% protected against mismatching, pin spacing	
- 5mm	2
- 5mm PressIn technique	2
- 7.5mm	2
MULTI CONNECTION SYSTEM MIDI 100% protected against mismatching, pin spacing	
- 5mm, 5.08mm	2
- 5mm PressIn technique	2
- 7.5mm, 7.62mm	2
MULTI CONNECTION SYSTEM MINI 100% protec- ted against mismatching, pin spacing	
- 3.5mm	2
- 3.5mm PressIn technique	2
- 3.5mm reflow soldering	2
- 3.81mm	2
- 3.81mm PressIn technique	2
- 3.81mm reflow soldering	2
- MINI HD	2
- MINI SL	2
MULTI CONNECTION SYSTEM, accessories	2
Multifunction timing relay	4 (115)
Multilevel installation terminal blocks	
TOPJOB® see ZKGT	
TOPJOB®S	1
Multilevel PCB terminal strips, double-deck, triple-deck, quadruple-deck terminal strips	2
Multilevel terminal blocks, double deck terminal blocks, triple deck terminal blocks, quadruple deck terminal blocks	
Double-deck, triple-deck terminal blocks	1
TOPJOB®S	1
Quadruple-deck terminal blocks	1
Multilevel terminal blocks, TOPJOB® terminal blocks see multilevel installation terminal blocks	
Multi-port device taps for DeviceNet	3 (598 - 599)
Multirange timing relay, pluggable	4 (114)
N	
NAMUR switching amplifier modules	4 (126)
N-conductor disconnect terminal blocks	
TOPJOB®	1
TOPJOB®S	1
Neon indicator modules	1
O	
OPC server for MODBUS/TCP	3

	Catalog Catalog (Page)
O	
Operating lever	2
Operating stickers	1, 2
Operating tool TOPJOB®S	4 (330), 1, 2, 3, 5 1
Optocoupler modules	
- Rail-mounted terminal block	4 (39 - 47)
- pluggable	4 (116 - 123)
Order form available on request	
P	
Parameterization files see "Configuration files"	3
Parameterizing software	4 (220), 3
Parameterizing software	4 (201), 3
Patching systems	
Common potential matrix	1
Terminal blocks for matrix patching (3-conductor double potential terminal blocks)	1
Terminal blocks for matrix patching and common potential terminal blocks (4-level terminal blocks, 8-level terminal blocks)	1
Matrix patchboards with CAGE CLAMP® connection	1
PCB terminal blocks	2
PCB terminal blocks and PCB terminal strips, with CAGE CLAMP® connection, PressIn technique, reflow soldering, with screw-clamp connection, with push-wire connection	
PERSPECTO	3
Phase selection WINSTA® MIDI	5
Phase selection WINSTA® MIDI	5
Pin modules for rail-mounted terminal blocks for Wire-Wrap and Thermi-Point	1
Plotters and accessories	4 (320 - 322), 1, 3
Plug WINSTA® MINI WINSTA® MIDI WINSTA® MAXI WINSTA® KNX	5 5 5 5
Pluggable fuse modules	
- for base terminal blocks	1
- for double-deck, triple-deck terminal blocks	1
Pluggable on base terminal blocks	
Pluggable wiring	3
Plugs - MULTI CONNECTION SYSTEM X-COM®-SYSTEM	2 1
Plugs for elevator shaft technology	2
POWER CAGE CLAMP termination	1
Power distribution disconnect terminal blocks, TOPJOB®S	1
Power supplies	
- DIN-rail-mountable	4 (260 - 263), 3
Power supplies	
- Constant voltage sources	4 (258 - 259), 3
- Power supplies, DIN-rail-mountable	4 (260 - 263), 3
- Power supplies, in shielded-metal housing	4 (236 - 247), 3
PressIn technique PCB terminal blocks MULTI CONNECTION SYSTEM, 3.5mm, 3.81mm, 5mm	2 2
Primary switch mode power supply units	4 (236 - 247), 3

	Catalog Catalog (Page)
P	
Printers and accessories	4 (316 - 322), 1, 3
PROFIBUS fieldbus components	3
PROFINET fieldbus connectors	3
PROFINET I/O fieldbus components	3
PROFIsafe, safety modules	3
Programmable fieldbus controllers	3
Programming interface, wireless	3
ProServe®, WAGO services	4 (310 - 322), 1, 3
PI100 analog input module	3
Pulse width output module	3
PUSH WIRE® connection	1
PUSH WIRE® connectors for junction boxes	1
PUSH WIRE® connectors for junction boxes	1
PUSH WIRE® connectors for junction boxes Ex e II	1
PUSH WIRE® connectors for junction boxes, MICRO	1
Push-in type wire jumpers for Rail-mounted terminal blocks TOPJOB®S	1 1
Push-wire connection	1, 2, 3
Push-wire connectors for EIB applications	
Q	
Quadruple-deck terminal strips for PCBs	2
Quadruple-deck, rail-mounted terminal blocks for fast electric motor wiring	1
R	
Radio adapter	3
Radio receiver in DIN-rail mountable enclosure	3 (252), 4
Radio receiver in WINSTA® box	3
Radio receiver module	3
Rail end cap, for DIN 35 rail	4 (327), 3
Rail-mountable modules for self-assembly	
Rail-mounted modules for building custom circuits	4 (191)
Rail-mounted spacer blocks (spacer)	1, 2
Rail-mounted terminal blocks for fast electric motor wiring (quadruple-deck)	1
Rail-mounted terminal blocks with CAGE CLAMP® connection with CAGE CLAMP®S connection with FIT CLAMP® (IDC) connection - with coupler function - with overvoltage protection - for building custom circuits	1 1 1 4 (270 - 277) 4 (297)
Rail-mounted terminal blocks with overvoltage protection	
Railway applications	4 (48, 138)
Reel (THR)	
- PCB	2
- MCS	2
- 2.5mm	2
- 3.5mm/3.81 mm	2
- 5mm	2
Reflow soldering: PCB terminal blocks	2
Relay modules	
- in DIN-rail mount enclosure	4 (140 - 145)
- terminal blocks	4 (32 - 62)
- with miniature relay	4 (100 - 115)
- DIN-rail-mountable	4 (32 - 149)
- pluggable	4 (100 - 109)
Relay output module	3

	Catalog Catalog (Page)
R	
Relay output module	3
Relay socket	
- DIN-rail-mountable	
- with miniature relay	
Repeater power supply	4 (202 - 203), 3
Repeater power supply	4 (202 - 203), 3
Repeater power supply, HART	4 (204 - 205)
Resettable fault indication modules - pluggable	4 (136 - 137)
Resistance sensors	3
Resistive temperature device (RTD) input module	
Resistor bridges (strain gauge)	3
Resistor gate modules - DIN-rail-mountable	4 (190)
Resistor gate modules	4 (190)
Ribbon cables	5
RJ-45 connection	4 (180 - 181), 3
RJ-45 connectors	3
RJ-45 interface module	4 (180 - 181)
RS-232 serial interface	3
RS-485 serial interface	3
RTC module	3
S	
S0 current meter interface	
S0 optocoupler modules	4 (124)
S0 supply modules	4 (125)
Safety modules	3
Safety relays, DIN-rail-mountable	
Sales regions, worldwide	1, 2, 3
Same potential terminal blocks and terminal blocks for matrix patching, 4-level terminal blocks, 8-level terminal blocks	1
Schuko, see WINSTA® MIDI cable assemblies	5
Screwdriver	4 (330), 1, 2, 3, 5
see "Operating tool"	4 (330), 1, 2, 5
Screw-type flanges - MINI - MIDI	2 2
Seminars	4 (346 - 347), 1, 2, 3
Sensor cable	3
Sensor terminal blocks and sensor LED terminal blocks	1
Sensor/Actuator boxes	3
Separation module	3
SERCOS-III fieldbus coupler	3
Serial interface	3 (228 - 229)
Service and programming software WAGO-I/O-SYSTEM 759	3
Service connectors	1
Services "ProServe"	4 (310 - 322), 3
Servo stepper controller	3
Shield (screen) clamps	1
Shield (screen) connecting system, Shield (screen) clamping saddle	4 (306 - 309), 1, 3
Shield (screen) terminal blocks angled type, f.e. TOPJOB® (rail-mounted) terminal blocks horizontal type, f.e. Triple-deck terminal blocks	1 1 1
Shield connecting plate - WINSTA® MINI - WINSTA® MIDI	5 5
Shorting plugs, WINSTA®	5

	Catalog Catalog (Page)
S	
Siemens-SIMATIC	4 (168)
Signal splitter	4 (206 - 207)
Snap-in connectors, WINSTA®	
- MINI	5
- MIDI	5
Snap-in mounting feet, MCS-MIDI Classic	
- 5/5.08mm	2
- 7.5/7.62mm	2
Snap-in mounting feet, MCS-MIDI, 100% protected against mismatching	
- 5mm	2
- 7.5mm	2
Socket	4 (50 - 61)
Sockets	
WINSTA® MINI	5
WINSTA® MIDI	5
WINSTA® MAXI	5
WINSTA® KNX	5
WAGO SCRIPT	2
WAGOframe	4 (220), 2, 3
Software for building installation, WAGO-I/O-SYSTEM 759	
Software tool	3
Solder pin strips	2
Solid state relays	4 (56 - 61, 78 - 79)
Spacers	2
Spacers for sensor and actuator terminal blocks	1
Specialty I/O modules	3
Specifications IEC/EN	4 (340 - 343), 1, 2, 3
Specifications UL - Underwriters Laboratories USA	
- Tests and test procedures per UL standards	1, 2
SPEEDWAY	3
SSI transmitter interface	3
Staggered jumpers for rail-mounted terminal blocks	1
TOPJOB®S	1
Step-down jumpers for through terminal blocks	
- f.e.	1
- s.e.	1
TOPJOB®S	1
Stepper controller	3
Stepper module	3
Strain relief housings	
for MCS-MINI	2
for MCS-MIDI	2
for WINSTA®	
- MINI	5
- MIDI	5
Strain relief plates	
for female plugs and male connectors with CAGE CLAMP® connection for MULTI CONNECTION SYSTEM MICRO	2
for MCS-MINI	2
for MCS-MIDI	2
for MULTI CONNECTION SYSTEM MICRO, MIDI, MINI	
Stripping knife for flat cables	5
Stripping tools	4 (284), 1, 2, 3, 5
Subsidiaries and representatives, WAGO worldwide	4 (360 - 361), 1, 2, 3, 5
Supply module	3
Supply module, WINSTA® IDC	5
Supply terminal blocks - single conductor ground (earth) terminal block	
TOPJOB®	1
TOPJOB®S	1
N-conductor disconnect terminal blocks	1
TOPJOB®	1
TOPJOB®S	1
Surge suppression devices	
- Rail-mounted terminal blocks	4 (274 - 277)

	Catalog Catalog (Page)
S	
Surge suppression devices	
- pluggable	4 (278 - 283)
Surge suppression devices	4 (278 - 283)
Surge suppression devices	4 (278 - 283)
Switching modules	4 (145)
- pluggable	4 (127)
Switching modules, changeovers, pluggable	4 (127)
Switching relay modules	
- in rail-mounted terminal blocks	4 (32 - 62)
- in DIN-rail-mount enclosure	4 (140 - 145)
- DIN-rail-mountable	4 (32 - 149)
- pluggable	4 (100 - 109)
System I/O modules	3
System wiring	4 (168 - 178), 3
T	
T marker tag	1
Tape (THR)	
- PCB	2
- MCS	2
Tap-off modules	
WINSTA® IDC	5
Tapp-off modules	1
T-distribution connector	
- WINSTA® MINI	5
- WINSTA® MIDI	5
- WINSTA® KNX	5
general	1, 2, 3
hazardous areas	1, 3
for use with G fuses	1
Technical support	3
Telecontrol technology	3
Telecontroller	3
Temperature range, extended	4 (48, 138), 3
Temperature transducer modules	4 (224 - 228)
Temperature transducer modules, pluggable	
Temperature transducers	4 (208 - 215)
Terminal block marking	1, 2
Terminal blocks and terminal strips with fixing flanges or snap-in mounting feet	
- f.e.	1
- s.e.	1
Terminal blocks for PCBs	2
Terminal blocks for pluggable modules	4 (Section 1)
Terminal blocks for pluggable modules, f.e.	
4 (100 - 138, 224 - 232, 278 - 282, 294 - 295)	
Terminal strips for electrical devices	1
Terminal strips and modular terminal blocks with fixing flanges or snap-in mounting feet, f.e.	1
s.e.	1
Terminal strips for electrical devices	1
Terminal strips for PCBs	
with locking slide,	2
double-deck terminal strips,	2
triple-deck terminal strips,	2
quadruple-deck terminal strips,	2
f.e. and s.e.,	2
for PressIn technique,	2
for Reflow soldering,	2
High-current terminal strips,	2
with finger operated levers,	2
1-conductor,	2
2-conductor	2
Test pin	2
Test plug adapters for	
PCB terminal blocks 255, 256, 257 Series	2
- Miniature rail-mounted terminal blocks,	
rail-mounted terminal blocks	1

	Catalog Catalog (Page)
T	
Test plug modules with	
CAGE CLAMP® connection	1, 2
CAGE CLAMP®S connection	1
Test plugs for MULTI CONNECTION SYSTEM MIDI	2
Testboy	4 (329), 1, 2, 3
Tests and testing procedures	1, 2
Electrical tests, environmental tests, mechanical tests, material tests	2
Thermal transfer printers	4 (316), 3
Thermocouple	3
Threaded flanges	
- MINI	2
- MIDI	2
Threshold value switch	4 (218 - 219)
Through terminal blocks with insulation displacement connection (FIT CLAMP)	1
Through terminal blocks, f.e.	
angled type	1
for transformer circuits	1
suitable for fuse terminal blocks for automotive blade-style fuses	1
TOPJOB® (rail-mounted) terminal blocks	1
TOPJOB®S (rail-mounted) terminal blocks	1
horizontal type	1
5 mm wide; 4 mm ²	1
double-deck, triple-deck terminal blocks	1
TOPJOB®S	1
TOPJOB®S (rail-mounted) terminal blocks	1
Distribution terminal blocks	1
TOPJOB®S	1
Through terminal blocks, miniature for DIN 15 rail and DIN 35 rail	1
Through terminal blocks, s.e.	1
high current through terminal blocks	1
Time delay relay modules	
- pluggable	4 (110 - 115)
Tools	4 (328 - 331), 1, 2, 3, 5
TO-PASS®	3
TOPJOB® terminal blocks with CAGE CLAMP®S connection	
Through terminal blocks	1
Multilevel installation terminal blocks	
N-conductor disconnect terminal blocks	1
Power distribution disconnect terminal blocks	1
Shield (screen) terminal blocks	1
Ground (earth) conductor terminal blocks	1
Distribution terminal blocks (see "Multilevel installation terminal blocks")	
Distribution terminal blocks (see "Multilevel installation terminal blocks")	
Tools	1
TOPJOB®S terminal blocks with CAGE CLAMP®S connection	
Diode and LED terminal blocks	1
Double potential terminal blocks	1
Double-deck terminal blocks	1
Triple-deck terminal blocks	1
Through terminal blocks	1
Multilevel installation terminal blocks	1
N-conductor disconnect terminal blocks	1
Power distribution disconnect terminal blocks	1
Test plug adapter	1
Ground (earth) conductor terminal blocks	1
Disconnect terminal blocks for test and measurement	1
Fuse terminal blocks	1
Fuse plugs	1
Fused terminal blocks with pivoting fuse holder	1
Connectors	1
Distribution supply terminal blocks	1
Touch monitor	3
Training	4 (346 - 347), 3
Transducers	4 (Section 3)

Catalog
Catalog (Page)

T

Transient suppression devices	
- Terminal blocks	
- pluggable	
Transverse switching terminal blocks	1
Triple-deck installation terminal blocks see TOPJOB®	
Triple-deck terminal blocks, f.-e. TOPJOB®S	1
diode terminal blocks, LED terminal blocks TOPJOB®S	1
Triple-deck terminal strips for PCBs	2
TTY interface	3
Twin ferrules	

U

UL specifications - Underwriters Laboratories USA	1, 2
Up/down counters	3
User manual on fieldbus components	3

V

Variable resistor terminal blocks, f.-e.	1
Varistor protective circuit	
Vertically movable marking system	1
Vibration velocity/bearing condition monitoring	3
Visu Panel	3
Voltage sources, constant	4 (258 - 259), 3
Voltage tester	4 (329), 1, 2, 3

W

WAGO	
- in Germany	4 (360 - 361), 1, 2, 3
- worldwide	4 (362 - 363), 1, 2, 3, 5
WAGO "ProServe"	4 (310 - 322), 1, 3
WAGO CAGE CLAMP® connection	1, 2, 3
WAGO CAGE CLAMP®S connection	1, 2, 3, 5
WAGO online	3
WAGO OPC	3
WAGO ribbon cables	4 (179), 3
WAGO services	1, 3
WAGO SPEEDWAY	3
WAGOframe	4 (220), 3
WAGO-I/O-CHECK	3
WAGO-I/O-IPC	3
WAGO-I/O-PRO	3
WAGO USB Service Cable	4 (221), 3
WCB Combi marking system	1
Web Panel	3
WFB Continuous marking strips	1
WINSTA®	5
WINSTA® radio switching receiver	4 (289), 3, 5
Wire cutter	
see „Miniature (rail-mounted) terminal blocks“	
Wire harness support	1
Wire jumpers for rail-mounted terminal blocks	
- pluggable	1
TOPJOB®S	1

Catalog
Catalog (Page)

W

Wire marking	4 (324 - 325), 1, 3
Wireless technology	3
Wire-tap branch connectors	
for ex. in elevator shaft technology	2
Wiring aid, WINSTA®	5
Wiring, pluggable	3
WMB Inline	4 (323), 1, 3
WMB Multi marking system	4 (323), 1, 2, 3
WSB Quick marking system	4 (323), 1, 2

X

X-COM®S-SYSTEM	1
Base terminal block, female plugs with CAGE CLAMP®S connection	1
X-COM®-SYSTEM	
- Base terminal blocks	1
- Female plugs with CAGE CLAMP® connection	1
- Male connectors CAGE CLAMP® connection	1
- Headers with solder pins	1

Catalog
Catalog (Page)

Item No.	Page	Item No.	Page	Item No.	Page	Item No.	Page
206 Series		210 Series		248 Series			
206-118	329	210-110	49	248-450	49	258-363	322
206-124	328	210-112	326	248-451	49	258-364	322
206-125	328	210-113	326	248-452	49	258-365	322
206-126	328	210-114	326	248-453	49	258-366	322
206-127	328	210-115	326	248-454	49	258-367	322
206-128	328	210-118	326	248-455	49	258-368	322
206-170	331	210-133	309			258-369	322
206-171	331	210-148	326	248-501	323	258-370	322
206-173	331	210-149	326	.../000-002	323	258-371	322
206-174	331	210-196	326	.../000-005	323	258-372	322
		210-197	326	.../000-006	323	258-373	322
206-501	328	210-198	326	.../000-007	323	258-374	322
206-502	328			.../000-012	323	258-375	322
206-503	328	210-492	295	.../000-017	323	258-377	322
				.../000-023	323	258-378	322
206-802	329	210-533	300	.../000-024	323	258-379	322
206-804	329			248-502	49	258-380	322
		210-701	318	248-503	49	258-381	322
209 Series		210-703	318	248-504	49	258-382	322
209-109	327	210-704	318	248-505	49	258-383	322
209-112	323	210-705	318	248-506	49	258-387	322
209-113	323	210-705/000-002	318	248-566	49	258-388	322
209-114	323	210-706	318			258-389	322
209-119	302	210-706/000-002	318	249 Series		258-390	322
209-120	302	210-707	318	249-116	327	258-391	322
209-140	323	210-707/000-002	318	249-117	327	258-392	322
209-188	302	210-708	318	249-118	323	258-393	322
		210-719	330	249-119	323	258-394	322
209-501	323	210-720	330	249-120	323	258-396	322
.../000-002	323	210-721	330			258-397	322
.../000-005	323	210-722	330	249-606	139	258-398	322
.../000-006	323	210-732	318	249-607	139	258-399	322
.../000-007	323			249-608	139		
.../000-012	323	211 Series		249-622	139	258-410	322
.../000-017	323	211-110	325	249-623	139	258-412	322
.../000-023	323	211-111	325	249-651	139	258-450	320
.../000-024	323	211-112	325	249-653	139	258-451	320
209-552	139	211-113	325	249-654	139	258-452	321
		211-114	325	249-656	139	258-452/000-002	321
209-601	139	211-115	325			258-452/000-003	321
209-682	139	211-120	325	258 Series		258-452/000-004	321
209-685	139	211-121	325	258-139	321	258-452/000-005	321
209-686	139	211-122	325	258-140	321	258-452/000-007	321
209-690	139	211-123	325	258-141	321	258-452/000-010	321
209-691	139	211-124	325	258-143	317	258-457	321
209-692	139	211-125	325	258-144	317	258-470	322
209-693	139	211-129	325	258-145	317	258-471	322
		211-150	325	258-146	321	258-472	322
209-701	139	211-151	325	258-147	321	258-473	322
209-701/000-002	139	211-155	325	258-149	317		
209-701/000-005	139	211-156	325	258-150	317		
209-701/000-006	139			258-157	317		
209-701/000-007	139	211-211	318	258-161	317		
209-701/000-012	139			258-162	317		
209-701/000-017	139	216 Series		258-166	317		
209-701/000-023	139	216-542	81	258-169	317		
209-701/000-024	139			258-171	317		
209-702	139			258-173	317		
209-782	139			258-177	317		
209-783	139			258-178	317		
209-784	139						
209-787	139			258-226	321		
209-789	139			258-227	321		
				258-228	321		
209-951	139			258-229	321		
209-952	139			258-298	316		
209-953	139						
209-954	139			258-326	321		
209-955	139			258-327	321		
209-957	139			258-328	321		
209-994	139			258-342	317		
209-995	139			258-343	316		
209-996	139			258-350	320		
209-997	139			258-350/000-001	321		
				258-350/000-002	321		
				258-350/000-003	321		
				258-350/000-004	321		
				258-361	322		
				258-362	322		

Item No.	Page	Item No.	Page	Item No.	Page	Item No.	Page
280 Series		286 Series					
280-101	296	286-110	294	286-450	112	286-751	116
280-340	274	286-111	294	286-460	113	286-752	116
280-341	274	286-112	294	286-462	113	286-752/002-000	119
		286-113	294	286-464	113	286-754	117
				286-470	113	286-756	117
280-502/281-582	275	286-302	101	286-472	113	286-758	117
280-502/281-583	275	286-303	101	286-474	113	286-790	123
280-502/281-584	275	286-304	101			286-791	121
280-502/281-585	275	286-304/004-000	138	286-502	101	286-792	122
280-502/281-586	275	286-305	101	286-503	101	286-794	122
280-502/281-587	275	286-306	101	286-504	101		
280-502/281-588	275	286-307	101	286-505	101	286-803	133
280-502/281-589	275	286-307/004-000	138	286-506	101	286-805	133
280-502/281-590	275	286-308	101	286-507	101	286-807	133
280-502/281-591	275	286-310	103	286-508	101	286-809	133
280-502/281-592	275	286-311	103	286-510	103	286-813	133
280-502/281-593	275	286-312	103	286-511	103	286-815	133
280-502/281-594	275	286-312/004-000	138	286-512	103	286-817	133
280-502/281-595	275	286-313	103	286-513	103	286-819	133
280-502/281-602	274	286-314	103	286-514	103	286-822	134
280-502/281-603	274	286-315	103	286-515	103	286-825	135
280-502/281-604	274	286-316	103	286-516	103	286-826	134
280-502/281-605	274	286-318	104	286-520	104	286-830	130
280-502/281-606	274	286-319	104	286-536	105	286-831	281
280-502/281-607	274	286-320	104	286-540	105	286-832	282
280-502/281-608	274	286-320/004-000	138	286-544	105	286-833	280
280-502/281-609	274	286-321	104	286-547	105	286-834	280
280-502/281-610	274	286-322	104	286-548	105	286-834/024-000	281
280-502/281-611	274	286-324	104	286-552	106	286-835	278
280-502/281-612	274	286-326	104	286-555	106	286-835/115-000	278
280-502/281-613	274	286-327	104	286-556	106	286-836	278
280-502/281-614	274	286-328	104	286-564	100	286-838	279
		286-328/004-000	138	286-566	100	286-838/115-000	279
280-503/281-579	276	286-329	104	286-567	100	286-840	130
280-503/281-580	276	286-330	104	286-568	100	286-841	282
280-503/281-581	276	286-332	104	286-570	109	286-842	282
		286-334	105	286-571	109	286-843	282
280-601	296	286-335	105	286-578	106	286-844	282
280-606	296	286-336	105	286-579	106	286-860	224
280-608	138	286-336/001-000	138	286-594	102	286-860/000-300	227
280-609	138	286-337	105			286-860/150-030	226
280-610	296	286-338	105	286-600	110	286-861	224
280-616	296	286-339	105	286-602	110	286-861/000-300	227
280-618	138	286-342	105	286-604	110	286-861/150-030	226
280-619	138	286-343	105	286-604/004-000	138	286-862	224
280-621	296	286-344	105	286-610	110	286-862/000-300	227
280-628	138	286-344/004-000	138	286-612	110	286-862/150-030	226
280-629	138	286-345	105	286-614	110	286-863	225
280-636	138	286-346	105	286-616	114	286-864	225
280-638	138	286-347	105	286-640	115	286-865	225
280-639	138	286-350	106	286-640/004-000	138	286-866	225
280-681	296	286-351	106	286-659	128	286-867	225
280-686	296	286-352	106	286-661	128	286-868	225
		286-352/004-000	138	286-662	129	286-870	224
280-762	138	286-353	106	286-664	129	286-870/000-300	227
280-763	138	286-354	106	286-665	129	286-870/150-030	226
280-764	138	286-355	106	286-681	136	286-871	224
280-765	138	286-364	100	286-683	137	286-871/000-300	227
		286-364/004-000	138	286-684	136	286-871/150-030	226
280-801	296	286-365	100			286-872	224
280-802	296	286-366	100	286-700	116	286-872/000-300	227
280-803	296	286-368	100	286-701	116	286-872/150-030	226
280-804	296	286-369	100	286-702	116	286-873	228
280-804/281-419	131	286-370	100	286-704	117	286-874	228
280-833	296	286-375	106	286-706	117	286-875	228
		286-376	107	286-708	117	286-880	126
280-901	296	286-380	109	286-720	118	286-881	126
280-916	296	286-381	109	286-721	118	286-890	132
		286-384	107	286-723	119	286-891	132
		286-394	102	286-725	121	286-895	127
		286-394/004-000	138	286-726	120	286-896	127
		286-395	102	286-728	120		
				286-730	120	286-904	108
		286-426	111	286-732	120	286-906	108
		286-427	111	286-733	120	286-906/004-000	138
		286-428	111	286-734	120	286-938	123
		286-440	112	286-740	124		
		286-442	112	286-740/001-000	124		
		286-444	112	286-741	124		
		286-446	112	286-742	125		
		286-448	112	286-750	116		

Item No.	Page	Item No.	Page	Item No.	Page	Item No.	Page
287 Series						704 Series	
287-474	95	288-816	263	289-540	153	704-5003	178
287-475	94	288-824	254	289-541	153	704-5004	175
		288-895	266	289-542	153	704-5013	178
287-774	91	289 Series		289-543	153	704-5014	175
				289-544	153	704-5024	174
287-804	92	289-101	186	289-545	153	704-5034	175
287-814	92	289-102	191	289-546	153	704-5044	174
287-824	92	289-103	186	289-547	153	704-5054	176
287-834	92	289-105	187	289-548	153	704-5064	177
287-853	93	289-105	187	289-549	153	704-5074	176
287-854	93	289-111	188	289-550	155		
		289-113	190	289-551	155		
288 Series		289-114	190	289-552	155		
		289-121	188	289-553	155	706 Series	
288-001	302	289-131	191	289-554	155	706-3057/300-100	179
288-002	302	289-151	189	289-555	155	706-3057/300-200	179
288-003	302	289-172	181	289-556	155	706-3057/300-300	179
		289-174	182	289-557	155		
288-111	98	289-175	182	289-558	155	706-7753/302-100	179
288-112	98	289-176	181	289-559	155	706-7753/302-200	179
288-113	98	289-177	180	289-575	156		
288-131	98	289-178	180	289-576	156	709 Series	
288-132	98			289-577	156		
288-133	98	289-201	189	289-578	156	709-120	318
288-151	99	289-202	189	289-585	156	709-177	317
288-152	99			289-586	156	709-178	317
288-153	99	289-401	161	289-587	156	709-196	300
		289-402	161	289-588	156	709-197	88
288-304	89	289-403	161			709-198	88
288-312	90	289-404	161	289-611	160		
288-320	94	289-405	161	289-612	160	709-350	309
288-364	88	289-406	161	289-613	160	709-352	309
288-368	88	289-407	161	289-614	160		
288-380	95	289-408	161	289-615	160	750 Series	
		289-409	161	289-616	160		
288-412	97	289-422	163	289-617	160	750-923	221
288-413	97	289-423	163	289-618	160		
288-414	97	289-424	163	289-619	160	758 Series	
288-415	97	289-425	163	289-620	157		
288-416	97	289-426	163	289-621	157	758-910	290
288-418	97	289-427	163	289-623	157	758-940/001-000	290
288-422	97	289-430	164	289-624	157	758-940/003-000	290
288-423	97	289-431	164	289-650	158	758-940/002-000	290
288-424	97	289-434	162	289-652	158	758-940/004-000	290
288-425	97	289-436	162	289-664	184		
288-426	97	289-440	152	289-665	184	759 Series	
288-428	97	289-441	152	289-666	184		
288-428	97	289-442	152	289-667	185	759-370	220
288-435	96	289-443	152	289-671	185		
288-437	96	289-444	152	289-680	168	770 Series	
		289-444	152	289-681	168		
288-504	89	289-445	152	289-682	169	770-103	289
288-508	89	289-446	152	289-682	169	770-113	289
288-512	90	289-447	152	289-683	169	770-114	289
288-554	89	289-448	152	289-684	170		
288-564	88	289-449	152	289-685	170	770-629/101-000	289
288-565	88	289-450	154	289-686	171	770-629/102-000	289
288-567	88	289-451	154	289-687	171		
288-568	88	289-452	154				
		289-453	154	289-720	159		
288-600	300	289-454	154	289-721	159		
288-601	300	289-455	154	289-722	159		
288-602	300	289-456	154	289-723	159		
288-620	301	289-457	154	289-725	159		
288-621	301	289-458	154	289-726	159		
288-622	301	289-459	154	289-727	159		
288-626	301			289-728	159		
288-627	301	289-501	161				
		289-502	161	289-822	166		
288-758	90	289-503	161	289-907	258		
288-761	90	289-504	161	289-913	266		
288-762	90	289-505	161				
		289-506	161				
288-800	258	289-507	161				
288-801	259	289-508	161				
288-808	261	289-509	161				
288-809	260	289-510	161				
288-810	260	289-522	164				
288-812	262	289-523	165				
288-813	261	289-526	164				
288-814	262	289-527	165				
288-815	262	289-531	165				

Item No.	Page	Item No.	Page	Item No.	Page	Item No.	Page
786 Series		788 Series				791 Series	
786-101	294	788-100	77	788-607	67	791-107	308
786-102	294	788-101	77	788-608	67	791-111	308
786-103	294	788-102	77	788-615	67	791-117	308
		788-103	77	788-616	67	791-124	308
786-301	230	788-113	80			792 Series	
786-302	230	788-114	80	788-700	78	792-800	270
786-303	230	788-115	80	788-701	78	792-801	270
786-304	231	788-116	80	788-720	79	792-802	271
786-305	231	788-117	80	789 Series		792-803	271
786-306	231	788-120	80	789-112	146	792-804	272
786-307	231	788-121	80	789-120	298	792-805	272
786-308	231	788-122	80	789-122	298		
786-309	231	788-123	80	789-124	298	793 Series	
786-321	230	788-124	80	789-126	298	793-501	63
786-322	230	788-125	80	789-127	298	793-502	63
786-323	230	788-150	74	789-128	298	793-503	63
786-324	232	788-152	74	789-129	298	793-504	63
786-325	232	788-154	74	789-130	298	793-505	63
786-326	232	788-155	75	789-131	298	793-506	63
786-337	232	788-156	74	789-132	298	793-566	63
786-338	232	788-157	75	789-133	298		
786-339	232	788-158	74	789-134	298		
		788-160	74			793-3501	323
787 Series		788-162	74	789-304	140	793-4501	323
		788-164	74	789-312	141	793-5501	323
787-601	240	788-166	74	789-313	141		
787-602	241	788-168	74	789-315	141	807 Series	
787-611	240	788-170	74	789-323	145	807-090/101-100	318
787-612	242	788-172	74	789-336	142		
787-613	243	788-174	74	789-352	143		
787-621	241	788-175	75				
787-622	242	788-176	74	789-504	140		
787-623	244	788-177	75	789-508	140		
787-632	243	788-178	74	789-512	141		
787-633	244	788-179	75	789-515	141		
787-692	245	788-180	74	789-516	141		
		788-181	75	789-516	141		
787-712	246	788-182	76	789-535	142		
787-722	246	788-183	76	789-536	142		
787-732	247	788-184	76	789-551	143		
		788-185	76	789-552	143		
787-822	236	788-186	76	789-570	144		
787-832	236	788-187	76	789-571	144		
787-840	237	788-188	76				
787-842	238	788-189	76	789-601	148		
787-844	239	788-190	76	789-602	148		
787-850	237	788-191	76				
787-852	238	788-192	76	789-810	149		
787-854	239	788-193	76	789-811	149		
787-860	248			790 Series			
787-861	249	788-303	64	790-100	309		
787-862	248	788-304	64	790-101	309		
787-870	250	788-305	64	790-108	308		
787-871	251	788-306	64	790-110	309		
787-872	251	788-307	64	790-112	309		
787-873	252	788-311	64	790-113	309		
787-875	250	788-312	64	790-114	309		
787-880	253	788-313	64	790-115	309		
787-881	253	788-314	64	790-116	308		
787-885	255	788-315	64	790-124	308		
787-890	256	788-324	68	790-133	309		
		788-334	68	790-134	309		
		788-334	68	790-140	308		
		788-354	70	790-144	309		
		788-355	71	790-145	309		
		788-374	73	790-190	309		
		788-375	73	790-191	309		
		788-384	72	790-192	309		
				790-193	309		
		788-404	66				
		788-412	66	790-300	309		
				790-301	309		
		788-506	65				
		788-507	65				
		788-508	65				
		788-512	65				
		788-515	65				
		788-516	65				
		788-528	69				
		788-538	69				

Item No.	Page	Item No.	Page	Item No.	Page	Item No.	Page
857 Series		859 Series		870 Series			
857-104	53	859-110	297	870-518	276		
857-107	53			870-519	276		
857-108	53	859-302	32				
857-150	52	859-303	32	870-523/281-579	276		
857-152	52	859-304	32	870-523/281-580	276		
857-153	52	859-305	32	870-523/281-581	276		
857-155	52	859-306	32	870-523/281-582	277		
857-157	52	859-307	32	870-523/281-583	277		
857-161	62	859-308	32	870-523/281-584	277		
857-162	62	859-314	33	870-523/281-585	277		
857-164	62	859-317	33	870-523/281-586	277		
857-165	62	859-318	35	870-523/281-587	277		
857-167	62	859-353	32	870-523/281-588	277		
857-168	62	859-354	32	870-523/281-589	277		
		859-355	32	870-523/281-590	277		
857-303	50	859-357	32	870-523/281-591	277		
857-304	50	859-358	32	870-523/281-592	277		
857-305	50	859-359	34	870-523/281-593	277		
857-306	50	859-360	34	870-523/281-594	277		
857-307	50	859-367	35	870-523/281-595	277		
857-308	50	859-368	36				
857-314	51	859-384	48				
857-317	51	859-386	48				
857-318	51	859-390	36	2009 Series			
857-354	50	859-391	37	2009-110	317		
857-357	50	859-392	38	2009-114	323		
857-358	50	859-393	48	2009-115	323		
857-364	51	859-394	48	2009-135	323		
857-367	51	859-397	48				
857-368	51	859-398	37				
		859-398	48				
857-400	194	859-399	48				
857-401	196						
857-409	198	859-402	49				
857-411	200	859-403	49				
857-412	200	859-404	49				
857-420	202	859-405	49				
857-421	204	859-406	49				
857-423	206	859-407	49				
857-451	201	859-408	49				
857-452	201	859-409	49				
		859-410	49				
857-531	218	... /000-005	49				
		... /000-006	49				
857-704	56	... /000-029	49				
857-707	56						
857-708	57	859-500	49				
857-714	58	859-501	297				
857-717	58	859-525	49				
857-718	59						
857-724	60	859-702	44				
857-727	60	859-706	45				
857-728	61	859-708	44				
		859-712	43				
857-800	208	859-720	41				
857-801	210	859-730	42				
857-810	212	859-740	42				
857-811	214	859-752	45				
857-819	216	859-756	46				
		859-758	46				
858 Series		859-772	43				
		859-791	39				
858-100	85	859-793	39				
858-110	86	859-794	41				
858-150	84	859-795	40				
858-151	84	859-796	40				
858-152	84						
858-153	84	859-801	264				
		859-802	264				
858-304	82	859-804	265				
858-314	82	859-805	265				
858-402	86	859-902	47				
858-508	83						
858-518	83						

Argentina

Bruno Schillig S.A.
Arenales 4030, B1604CFD
Florida, PBA
Phone +54 11 4730 1100
Fax +54 11 4761 7244
robertor@schillig.com.ar

Australia

NHP ELECTRICAL ENGINEERING
PRODUCTS PTY LTD
43-67 River Street
Richmond, Victoria, 3121, P.O. Box 199
Phone +61 3 9429 2999
Fax +61 3 9429 1075
export@wago.com

Austria

WAGO Kontakttechnik Ges.m.b.H.
Laxenburger Straße 244
1230 Wien
Phone +43 1 6150780
Fax +43 1 6150775
info.at@wago.com

Belarus

UP FEK
pr-t Pushkina 29_B
220015 Minsk
Phone +375 17 2102274
Fax +375 17 2102189
wago@fek.by

Belgium

WAGO Kontakttechnik
Excelsiorlaan 11
1930 Zaventem
Phone +32 2 7179090
Fax +32 2 7179099
info-be@wago.com

Bosnia and Herzegovina

please contact WAGO Bulgaria

Brasil

WAGO Eletroeletrônicos Ltda
Rua América Simões 1470
São Roque da Chave
Itupeva SP Brasil 13295-000
Phone +55 11 4591 0199
Fax +55 11 4591 0190
info.br@wago.com

Bulgaria

WAGO Kontakttechnik GmbH & Co. KG
Business Center Serdika, Building 1, Floor 4, Office 417
1330 Sofia
Phone +359 2 489 46 10
Fax +359 2 928 28 50
info-BG@wago.com

Canada

please contact WAGO USA

Chile

Desimat Chile
Av Puerto Vespucio 9670
Pudahuel Santiago
Phone +56 2 7470152
Fax +56 2 7470153
ventaschile@desimat.cl

China

WAGO ELECTRONIC (TIANJIN) Co., LTD
No.5, Guan Hui Road, Wuqing Development Area
Tianjin 301700
Phone +86 22 59617688
Fax +86 22 59617668
info-cn@wago.com

Columbia

T.H.L. Ltda.
Cra. 49 B # 91-33
Bogotá
Phone +57 1 621 85 50
Fax +57 1 621 60 28
ventas-thl@thl-ldta.com

Croatia

M.B.A. d.o.o. za trgovinu i zastupanje
Frana Supila 5
51211 Matulji HR
Phone +385 51 275-736
Fax +385 51 275-066
mba@ri.hinet.hr

GENERA CTR d.o.o.

Siget 18 b
10020 Zagreb
Phone +385 13647849
Fax +385 13636662
wago@geneza.hr

Czech Republic

WAGO Elektro spol. sr. o.
Rozvodova 1116/36
143 00 Praha 4 - Modřany
Phone +420 261 090 143
Fax +420 261 090 144
info.cz@wago.com

Denmark

WAGO Danmark
Filial of WAGO Kontakttechnik GmbH & Co. KG
Lejrevej 17
3500 Værløse
Phone +45 44 357777
Fax +45 44 357787
salg.dk@wago.com

Ecuador

INSETEC CIA. LTDA.
El Zurriago 177 y El Vengador
P.O. Box 17-16-016
Quito
Phone +593 2 2 26 91 48
Fax +593 2 2 46 18 33
g.castro@insetec.com.ec

Egypt

IBN Engineering Instrumentation & Control
71 a El Shaheed Ahmed Hamdi St.
King Faisal, Giza
Phone +20 2 7214350
Fax +20 2 7221709
sales@ibnengineering.com

Estonia

Eltarko OÜ
Laki 14 - 502
10621 Tallinn
Phone +372 651 7731
Fax +372 651 7786
andres@eltarko.ee

Finland

WAGO Kontakttechnik GmbH & Co. KG
Filial i Finland
Vellamonkatu 30 B
00550 Helsinki
Phone +358 9 7744 060
Fax +358 9 7744 0660
tilaus@wago.fi

France

WAGO CONTACT S.A.
Paris Nord 2
83 Rue des Chardonnerets
B.P. 55065 - Tremblay en France
95947 - ROISSY CDG CEDEX
Phone +33 1 48172590
Fax +33 1 48632520
info-fr@wago.com

Germany

WAGO Kontakttechnik GmbH & Co. KG
Postfach 28 80, 32385 Minden
Hansastraße 27
32423 Minden
Phone +49 571 887-0
Fax +49 571 887-169
info@wago.com

WAGO Kontakttechnik GmbH & Co. KG
Waldstraße 1
99706 Sondershausen
Phone +49 3632 659-150
Fax +49 3632 659-153
info@wago.com

Great Britain

WAGO Limited
Triton Park, Swift Valley Industrial Estate
RUGBY
Warwickshire, CV21 1SG
Phone +44 1788 568008
Fax +44 1788 568050
uksales@wago.com

Greece

PANAGIOTIS SP. DIMOULAS - BIOMAT
Kritis Str. 26
10439 Athen
Phone +30 210 883 3337
Fax +30 210 883 4436
export@wago.com

Hong Kong

National Concord Eng., Ltd.
Unit A-B, 5/F.
Southeast Industrial Building
611-619 Castle Peak Road
Tsuen Wan, N.T.
Phone +852 24292611
Fax +852 24292164
sales@nce.com.hk

Hungary

WAGO Hungária KFT
Ipari Park, Gyár u. 2
2040 Budapest
Phone +36 23 502-170
Fax +36 23 502-166
info.hu@wago.com

Iceland

S. Gudjonsson ehf.
Audbrekku 9-11
202 Kopavogur
Phone +354 520-4500
Fax +354 520-4501
export@wago.com

India

WAGO & CONTROLS (INDIA) LTD.
C-27, Sector-58, Phase-III
Noida-201 301
Gautam Budh Nagar (U.P.)
Phone +91 120 2 580409 10
Fax +91 120 2 580081
info@wagoindia.com

Indonesia

please contact WAGO Singapore

Iran

Patsa Industry
No. 2 Bahar St.
South Shiraz Ave
P.O. Box.: 15875-1698
14369 Tehran
Phone +98 21 88047626
Fax +98 21 88040886
export@wago.com

Ireland

Drives & Controls
Unit F4, Riverview Business Park
Nangor Road
Dublin 12
Phone +353 1 4604474
Fax +353 1 4604507
wago@drivesandcontrols.ie

Israel

Comtel Israel Electronic Solutions Ltd.
Bet Hapaamon
20 Hataas Street
P.O. Box 66
44425 Kefar-Saba
Phone +972 9 76 77 240
Fax +972 9 76 77 243
sales@comtel.co.il

Italy

WAGO ELETTRONICA SRL
Via Parini 1
40033 Casalecchio di Reno (BO)
Phone +39 051 6132112
Fax +39 051 6272174
info-ita@wago.com

Japan

WAGO Co. of JAPAN Ltd.
Nittetsu ND-Tower Building 4F
Kameido 1-5-7
Koto-Ku
Tokyo 136-0071
Phone +81 3 5627 2050
Fax +81 3 5627 2055
info-jp@wago.com

Kazakhstan

TOO INTANT IT
ul. Muratbaeva, d. 61
050026 Almaty
Phone +7 727 2371492
Fax +7 727 2980151
info@intant.kz

TOO Technik-Trade
ul. i. A. Protosanova, 81
070004 Ust-Kamenogorsk
Phone +7 7232 254064
Fax +7 7232 253251
info@technik.kz

Korea

Mahani Electric Co. Ltd.
792-7 Yeoksam-Dong
Kangnam-Gu, 135-080
Seoul, Korea
Phone +82 2 2194 3300
Fax +82 2 2194 3397
export@wago.com

Kosovo

please contact WAGO Bulgaria

Kuwait

Kuwait Controls Company
Al Sour Street, Above Lufthansa Airline
Safat Kuwait 13062
Phone +965 222 54300
Fax +965 224 33698

Latvia

INSTABALT LATVIA SIA
Vestienas iela 6
Riga, LV-1035
Phone +371 790 1188
Fax +371 790 1180
info@instabalt.lv

Lebanon

G.T.C.
Antonine Project - Block G
P.O. BOX 70-1096 Antelias
Lebanon
Phone +961 4 521 029
Fax +961 4 521 029
rgemayel@inco.com.lb

Lithuania

INSTABALT LIT UAB
Savanoriu 187
Vilnius, 2053
Phone +370 52 322 295
Fax +370 52 322 247
info@instabalt.lt

Luxembourg

please contact WAGO Belgium

Macedonia

please contact WAGO Bulgaria

Malaysia

WAGO Representative Office Malaysia
No 806, Block A4, Leisure Commerce Square,
No 9, Jalan PJS 8/9, 46150 Petaling Jaya,
Selangor Darul Ehsan, Malaysia
Phone +60 3 7877 1776
Fax +60 3 7877 2776
kian.guan.tan@wago.com

Malaysia

HPH Materials (M) Sdn Bhd
No. 4, Jalan Nilam 1/6
Suban Hi-Tech Industrial Park
40000 Shah Alam
Selangor, D.E. Malaysia
Phone +60 3 5638 2213
Fax +60 3 5638 8213
info@hphmaterials.com

Setia Raya Teknik Sdn. Bhd.
40 & 42 Jalan SS15/4
Subang Jaya, 47500 P.J.
Selangor D.E. Malaysia
Phone +60 3 5633 5511
Fax +60 3 5633 3411
sales@setiaraya.com.my

Mexico

WAGO SA de CV
Av. Del Marques 38 Bodega 3
P. I. Bernardo Quintana
76240 El Marques, Querétaro
Phone +52 442 221 5946
Fax +52 442 221 5063
Toll-Free: 001-800-309-5975
info.mx@wago.com

Netherlands

WAGO Nederland
Laan van de Ram 19
7324 BW Apeldoorn
Phone +31 55 3683500
Fax +31 55 3683599
info.nl@wago.com

New Zealand

NHP NZ
7 Lockhart Place
Mt Wellington
New Zealand
Phone +64 9 2761967
Fax +64 9 2761992
export@wago.com

Norway

WAGO Norge NUF
Jerikoveien 20
1067 Oslo
Phone +47 22 30 94 50
Fax +47 22 30 94 51
info.no@wago.com

Peru

Desimat Peru
Av. Velasco Astete 2371
Surco Lima
Phone +51 1 2752776
Fax +51 1 2752765
export@wago.com

Philippines

please contact WAGO Singapore

Poland

WAGO ELWAG sp. z o. o.
ul. Piekna 58 a
50-506 Wrocław
Phone +48 71 3604670 78
Fax +48 71 3604699
wago.elwag@wago.com

Portugal

MORGADO & CA. LDA - SEDE
Estrada Exterior da
Circunvalação 3558/3560
Apartado 1057
4435 Rio Tinto
Phone +351 22 9770600
Fax +351 22 9770699
export@wago.com

Republic of Moldova

Electroservice Slavinschi T.T.
str. Bolgarskaia 9, office 6
2001 Kishinev
Phone +373 22 274427
Fax +373 22 224481
es@es.mldnet.com

Romania

WAGO Kontakttechnik GmbH & Co. KG
WAGO Representative Office Bucharest
Str. Nicolae G. Caramfil Nr. 26, Bl. 1D, Et. 3, Ap. 7, Sect. 1
Bucuresti
Romania
Phone +40 31 421 85 68
Fax +40 21 232 02 31
titus.reus@wago.com

VDR & Servicii srl

Str. Valeriu Braniste, nr. 60, ap.1, sector 3
Romania
Phone +40 21 3225074/76
Fax +40 21 3225075
office@componente-automatizari.ro

SC Civitronic SRL

Str. Prof. Gh. Langinescu Nr. 7
Timisoara, Romania
Phone +40 356 710 600
Fax +40 356 814 343
sales@civitronic.ro

Russia

OOO WAGO Kontakt Rus
Gostinichny proezd 4B
127106 Moscow
Russia
Phone +7 495 9874790
Fax +7 495 9874791
info.ru@wago.com

OOO Accent
ul. Novolitovskaja 15, office 518
194100 Saint-Peterburg
Phone +7 812 3274300
Fax +7 812 3274300
service@accent.ru

OOO Decima
Projesd 4922, d. 4, str. 1
124460 Moscow / Selenograd
Phone +7 495 9884858
Fax +7 495 9884858

OOO Firstmile
ul. Zuzinskaya, d. 6, korp. 2
117209 Moscow
Phone +7 495 3323640
Fax +7 495 3323641
info@firstmile.ru

OOO Prosoft
ul. Profsouznaya, 108
117437 Moscow
Phone +7 495 2340636
Fax +7 495 2340640
info@prosoft.ru

Saudi Arabia

Ali Zaid Al Quraishi & Partners Electrical Services of S.A.
Al Quraishi Center, King Khalid Street
P.O. Box 7386
Dammam-31462
Phone +966 3 8351155
Fax +966 3 8352297
export@wago.com

Serbia

please contact WAGO Bulgaria

AVALON Partners D.O.O.
Sir. Nemanjina 4/XII
11000 Belgrade / Serbia
Phone +381 11 268 53 11
Fax +381 11 268 41 78
Tel/Fax: 65 AVALONP
office@avalon.co.yu

Singapore

WAGO Electronic Pte Ltd
10 Upper Aljunied Link
#04-04 Johnson Controls Building
Singapore 367904
Phone +65 62866776
Fax +65 62842425
info-sing@wago.com

Slovakia

WAGO Elektrik spol. s r. o
Odborárska 52
83102 Bratislava
Phone +421 2 44458301
Fax +421 2 44458301
export@wago.com

Proelektro spol. s r.o.
83102 Bratislava
Phone +421 2 4458286
Fax +421 2 4458289
info@wago.sk

Slovenia

GENERA d.o.o.
Podmilscakova 18
1000 Ljubljana
Phone +386 14393050
Fax +386 14393090
wago@genera.si

IC elektronika d.o.o.
Vodovodna cesta 100
1000 Ljubljana
Phone +386 15680110
Fax +386 15689107
info@ic-elect.si

South Africa

Shorrock Automation (Pty) Ltd
Postnet Suite # 219
Private Bag X 8, Elardus Park
0047 Pretoria
Phone +27 12 3454449
Fax +27 12 3455145
sales@shorrock.co.za

Spain

DICOMAT S.L.
Avda. de la Industria, 36
Apartado Correos, 1.178
28108-Alcobendas (Madrid)
Phone +34 91 6621362
Fax +34 91 6610089
info@dicomat.com

Sweden

WAGO Sverige
WAGO Kontakttechnik GmbH
Tyskland Filial
Box 639, 17527 Järfälla
Datavägen 9 A, 17543 Järfälla
Phone +46 858410680
Fax +46 858410699
info.se@wago.com

Switzerland

WAGO CONTACT SA
Rte. de l'Industrie 19
Case Postale 168
1564 Domdidier
Phone +41/26 676 75 86
Fax +41/26 676 75 01
info.switzerland@wago.com

Syria

Zahabi Co.
8/5 Shouhadaya St., P.O. Box 8262
Aleppo
Phone +963 21 21 22 235 / 6
Fax +963 21 21 24 768
export@wago.com

Taiwan R.O.C.

WAGO Contact, Ltd.
5F, No.168, Jiankang Rd
Zhonghe City
Taipei County 23585, Taiwan
Phone +886 2 22250123
Fax +886 2 22251511
info.taiwan@wago.com

Thailand

WAGO Representative Office Thailand
4th Floor, KS Building
213/6-8 Rachada-Phisek Road
Ding Daeng Bangkok 10320
Phone +66 2 6935611
Fax +66 2 6935612
wago@asianet.co.th

US Power Distribution Co., Ltd.
4th Floor K.S. Building
213/6-8 Rachada Phisek Road
Ding Daeng, Bangkok 10400
Phone +66 2 2763040
Fax +66 2 2763049
wago@asianet.co.th

Turkey

WAGO Elektronik Sanayi ve Ticaret Ltd. Şti.
Barbaros Mahallesi Mimar Sinan Caddesi No 169
34746 Yenimahra - Kadıköy Istanbul
Turkey
Phone +90 216 472 1133
Fax +90 216 472 9910
info.tr@wago.com

Ukraine

NPP Logicon
Predslavinskaya street, 39, office 303
03150 Kiev
Phone +380 44 5228019
Fax +380 44 2611803
info@logicon.ua

OOO Mikropribor

ul. Katelnikova, 4
03115 Kiev
Phone +380 44 5369386
Fax +380 44 5369387
sales@micropribor.kiev.ua

NPP VD MAIS

ul. Dontsia 6
03061 Kiev
Phone +380 44 4928852
Fax +380 44 4928852
info@vdmis.kiev.ua

United Arab Emirates (UAE)

Binghalib Engineering Ent.
Trading Division
Al Khabeshi Area
P.O. Box 14743
Dubai
Phone +971 4 2674555
Fax +971 4 2674117
export@wago.com

USA

WAGO Corporation
N120 W19129 Freistadt Road
Germantown, WI 53022
Phone +1 262 255 6222
Fax +1 262 255 3232
Toll-Free: 1-800 DIN Rail (346-7245)
info.us@wago.com

Venezuela

PETROBORNAS, C.A.
Av. Principal UD 304-Zona Ind. Los Pinos
C.C. Los Pinos-Local E
8015-Puerto Ordaz-Edo. Bolivar
Phone +58 286 994 3406
Fax +58 286 994 5249
info@petrobornas.net

Vietnam

please contact WAGO Singapore

Version: 06/2009

Current addresses at www.wago.com

