

Operational Amplifier, Rail-to-Rail, Low Input Bias Current, 1.8 V to 5 V Single-Supply



SC70-5
 SQ SUFFIX
 CASE 419A
 STYLES 3

LMV301

The LMV301 CMOS operational amplifier can operate over a power supply range from 1.8 V to 5 V and has a quiescent current of less than 200 μ A, maximum, making it ideal for portable battery-operated applications such as notebook computers, PDA's and medical equipment. Low input bias current and high input impedance make it highly tolerant of high source-impedance signal-sources such as photodiodes and pH probes. In addition, the LMV301's excellent rail-to-rail performance will enhance the signal-to-noise performance of any application together with an output stage capable of easily driving a 600 Ω resistive load and up to 1000 pF capacitive load.

Features

- Single Supply Operation (or $\pm V_S/2$)
- V_S from 1.8 V to 5 V
- Low Quiescent Current: 185 μ A, Max with $V_S = 1.8$ V
- Rail-to-Rail Output Swing
- Low Bias Current: 35 pA, max
- No Output Phase-Reversal when the Inputs are Overdriven
- These are Pb-Free Devices

Typical Applications

- Portable Battery-Powered Instruments
- Notebook Computers and PDAs
- Cell Phones and Mobile Communication
- Digital Cameras
- Photodiode Amplifiers
- Transducer Amplifiers
- Medical Instrumentation
- Consumer Products

MARKING DIAGRAM

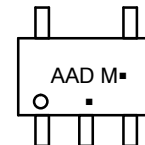

LMV301 = Specific Device Code
 M = Date Code
 ■ = Pb-Free Package

(Note: Microdot may be in either location)

*Date Code orientation and/or position may vary depending upon manufacturing location.

PIN CONNECTION

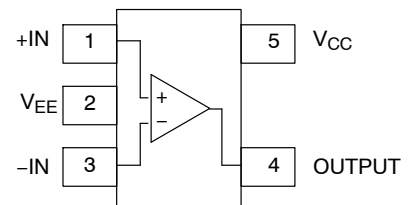

STYLE 3 PINOUT

ORDERING INFORMATION

See detailed ordering and shipping information in the dimensions section on page 11 of this data sheet.

LMV301

MAXIMUM RATINGS

Symbol	Rating	Value	Unit
V _S	Power Supply (Operating Voltage Range V _S = 1.8 V to 5.0 V)	5.5	V
V _{IDR}	Input Differential Voltage	±Supply Voltage	V
V _{ICR}	Input Common Mode Voltage Range	-0.5 to (V ₊) + 0.5	V
	Maximum Input Current	10	mA
t _{So}	Output Short Circuit (Note 1)	Continuous	
T _J	Maximum Junction Temperature (Operating Range -40°C to 85°C)	150	°C
J _A	Thermal Resistance (5-Pin SC70-5)	280	°C/W
T _{stg}	Storage Temperature	-65 to 150	°C
	Mounting Temperature (Infrared or Convection (30 sec))	260	
V _{ESD}	ESD Tolerance	100 1500	V
	Machine Model		
	Human Body Model		

Stresses exceeding those listed in the Maximum Ratings table may damage the device. If any of these limits are exceeded, device functionality should not be assumed, damage may occur and reliability may be affected.

1. Continuous short-circuit to ground operation at elevated ambient temperature can result in exceeding the maximum allowed junction temperature of 150°C. Output currents in excess of 45 mA over long term may adversely affect reliability. Also, shorting output to V₊ will adversely affect reliability; likewise shorting output to V₋ will adversely affect reliability.

LMV301

1.8 V DC ELECTRICAL CHARACTERISTICS (Unless otherwise specified, all limits are guaranteed for $T_A = 25^\circ\text{C}$, $V_{CC} = 1.8\text{ V}$, $R_L = 1\text{ M}\Omega$, $V_{EE} = 0\text{ V}$, $V_O = V_{CC}/2$)

Parameter	Symbol	Condition	Min	Typ	Max	Unit
Input Offset Voltage	V_{IO}	$T_A = -40^\circ\text{C to } +85^\circ\text{C}$		1.7	9	mV
Input Offset Voltage Average Drift	$T_C V_{IO}$	$T_A = -40^\circ\text{C to } +85^\circ\text{C}$		5		$\mu\text{V}/^\circ\text{C}$
Input Bias Current (Note 2)	I_B			3	35	pA
		$T_A = -40^\circ\text{C to } +85^\circ\text{C}$			50	
Common Mode Rejection Ratio	CMRR	$0\text{ V} \leq V_{CM} \leq 0.9\text{ V}$	50	63		dB
Power Supply Rejection Ratio	PSRR	$1.8\text{ V} \leq V_{CC} \leq 5\text{ V}$, $V_O = 1\text{ V}$, $V_{CM} = 1\text{ V}$	62	100		dB
Input Common-Mode Voltage Range	V_{CM}	For CMRR $\geq 50\text{ dB}$	0 to 0.9	-0.2 to 0.9		V
Large Signal Voltage Gain (Note 2)	A_V	$R_L = 600\Omega$	83	100		dB
		$T_A = -40^\circ\text{C to } +85^\circ\text{C}$	80			
		$R_L = 2\text{ k}\Omega$	83	100		
		$T_A = -40^\circ\text{C to } +85^\circ\text{C}$	80			
Output Swing	V_{OH}	$R_L = 600\Omega\text{ to } 0.9\text{ V}$ $T_A = -40^\circ\text{C to } +85^\circ\text{C}$	1.65 1.63			V
	V_{OL}	$R_L = 600\Omega\text{ to } 0.9\text{ V}$ $T_A = -40^\circ\text{C to } +85^\circ\text{C}$		75	100 120	mV
	V_{OH}	$R_L = 2\text{ k}\Omega\text{ to } 0.9\text{ V}$ $T_A = -40^\circ\text{C to } +85^\circ\text{C}$	1.5 1.4	1.76		V
	V_{OL}	$R_L = 2\text{ k}\Omega\text{ to } 0.9\text{ V}$ $T_A = -40^\circ\text{C to } +85^\circ\text{C}$		25	35 40	mV
Output Short Circuit Current (Note 2)	I_O	Sourcing = $V_O = 0\text{ V}$ Sinking = $V_O = 1.8\text{ V}$	10 20	60 160		mA
Supply Current	I_{CC}	$T_A = -40^\circ\text{C to } +85^\circ\text{C}$			185	μA

1.8 V AC ELECTRICAL CHARACTERISTICS (Unless otherwise specified, all limits are guaranteed for $T_A = 25^\circ\text{C}$, $V_{CC} = 1.8\text{ V}$, $R_L = 1\text{ M}\Omega$, $V_{EE} = 0\text{ V}$, $V_O = V_{CC}/2$)

Parameter	Symbol	Condition	Min	Typ	Max	Unit
Slew Rate	S_R			1		$\text{V}/\mu\text{s}$
Gain Bandwidth Product	GBWP	$C_L = 200\text{ pF}$		1		MHz
Phase Margin	Θ_m			60		$^\circ$
Gain Margin	G_m			10		dB
Input-Referred Voltage Noise	e_n	$f = 50\text{ kHz}$		50		$\text{nV}/\sqrt{\text{Hz}}$
Total Harmonic Distortion	THD	$A_V = +1$, $V = 1\text{ V}_{PP}$, $R_L = 10\text{ kW}$, $f = 1\text{ kHz}$		0.01		%

2. Guaranteed by design and/or characterization.

LMV301

2.7 V DC ELECTRICAL CHARACTERISTICS (Unless otherwise specified, all limits are guaranteed for $T_A = 25^\circ\text{C}$, $V_{CC} = 2.7\text{ V}$, $R_L = 1\text{ M}\Omega$, $V_{EE} = 0\text{ V}$, $V_O = V_{CC}/2$)

Parameter	Symbol	Condition	Min	Typ	Max	Unit
Input Offset Voltage	V_{IO}	$T_A = -40^\circ\text{C to } +85^\circ\text{C}$		1.7	9	mV
Input Offset Voltage Average Drift	$T_C V_{IO}$	$T_A = -40^\circ\text{C to } +85^\circ\text{C}$		5		$\mu\text{V}/^\circ\text{C}$
Input Bias Current (Note 2)	I_B			3	35	pA
		$T_A = -40^\circ\text{C to } +85^\circ\text{C}$			50	
Common Mode Rejection Ratio	CMRR	$0\text{ V} \leq V_{CM} \leq 1.35\text{ V}$	50	63		dB
Power Supply Rejection Ratio	PSRR	$1.8\text{ V} \leq V_{CC} \leq 5\text{ V}$, $V_O = 1\text{ V}$, $V_{CM} = 1\text{ V}$	62	100		dB
Input Common-Mode Voltage Range	V_{CM}	For CMRR $\geq 50\text{ dB}$	0 to 1.35	-0.2 to 1.35		V
Large Signal Voltage Gain (Note 2)	A_V	$R_L = 600\ \Omega$	83	100		dB
		$T_A = -40^\circ\text{C to } +85^\circ\text{C}$	80			
		$R_L = 2\text{ k}\Omega$	83	100		
		$T_A = -40^\circ\text{C to } +85^\circ\text{C}$	80			
Output Swing	V_{OH}	$R_L = 600\ \Omega \text{ to } 1.35\text{ V}$ $T_A = -40^\circ\text{C to } +85^\circ\text{C}$	2.55 2.53	2.62		V
	V_{OL}	$R_L = 600\ \Omega \text{ to } 1.35\text{ V}$ $T_A = -40^\circ\text{C to } +85^\circ\text{C}$		78	100 280	mV
	V_{OH}	$R_L = 2\text{ k}\Omega \text{ to } 1.35\text{ V}$ $T_A = -40^\circ\text{C to } +85^\circ\text{C}$	2.65 2.64	2.675		V
	V_{OL}	$R_L = 2\text{ k}\Omega \text{ to } 1.35\text{ V}$ $T_A = -40^\circ\text{C to } +85^\circ\text{C}$		75	100 110	mV
Output Short Circuit Current (Note 2)	I_O	Sourcing = $V_O = 0\text{ V}$ Sinking = $V_O = 2.7\text{ V}$	10 20	60 160		mA
Supply Current	I_{CC}	$T_A = -40^\circ\text{C to } +85^\circ\text{C}$			185	μA

2.7 V AC ELECTRICAL CHARACTERISTICS (Unless otherwise specified, all limits are guaranteed for $T_A = 25^\circ\text{C}$, $V_{CC} = 2.7\text{ V}$, $R_L = 1\text{ M}\Omega$, $V_{EE} = 0\text{ V}$, $V_O = V_{CC}/2$)

Parameter	Symbol	Condition	Min	Typ	Max	Unit
Slew Rate	S_R			1		$\text{V}/\mu\text{s}$
Gain Bandwidth Product	GBWP	$C_L = 200\text{ pF}$		1		MHz
Phase Margin	Θ_m			60		$^\circ$
Gain Margin	G_m			10		dB
Input-Referred Voltage Noise	e_n	$f = 50\text{ kHz}$		50		$\text{nV}/\sqrt{\text{Hz}}$
Total Harmonic Distortion	THD	$A_V = +1$, $V - 1\text{ V}_{PP}$, $R_L = 10\text{ kW}$, $f = 1\text{ kHz}$		0.01		%

2. Guaranteed by design and/or characterization.

LMV301

5.0 V DC ELECTRICAL CHARACTERISTICS (Unless otherwise specified, all limits are guaranteed for $T_A = 25^\circ\text{C}$, $V_{CC} = 5.0\text{ V}$, $R_L = 1\text{ M}\Omega$, $V_{EE} = 0\text{ V}$, $V_O = V_{CC}/2$)

Parameter	Symbol	Condition	Min	Typ	Max	Unit
Input Offset Voltage	V_{IO}	$T_A = -40^\circ\text{C to } +85^\circ\text{C}$		1.7	9	mV
Input Offset Voltage Average Drift	$T_C V_{IO}$	$T_A = -40^\circ\text{C to } +85^\circ\text{C}$		5		$\mu\text{V}/^\circ\text{C}$
Input Bias Current (Note 2)	I_B			3	35	pA
		$T_A = -40^\circ\text{C to } +85^\circ\text{C}$			50	
Common Mode Rejection Ratio	CMRR	$0\text{ V} \leq V_{CM} \leq 4\text{ V}$	50	63		dB
Power Supply Rejection Ratio	PSRR	$1.8\text{ V} \leq V_{CC} \leq 5\text{ V}$, $V_O = 1\text{ V}$, $V_{CM} = 1\text{ V}$	62	100		dB
Input Common-Mode Voltage Range	V_{CM}	For CMRR $\geq 50\text{ dB}$	0 to 4	-0.2 to 4.2		V
Large Signal Voltage Gain (Note 2)	A_V	$R_L = 600\ \Omega$	83	100		dB
		$T_A = -40^\circ\text{C to } +85^\circ\text{C}$	80			
		$R_L = 2\text{ k}\Omega$	83	100		
		$T_A = -40^\circ\text{C to } +85^\circ\text{C}$	80			
Output Swing	V_{OH}	$R_L = 600\ \Omega$ to 2.5 V $T_A = -40^\circ\text{C to } +85^\circ\text{C}$	4.850 4.840			V
	V_{OL}	$R_L = 600\ \Omega$ to 2.5 V $T_A = -40^\circ\text{C to } +85^\circ\text{C}$			150 160	mV
	V_{OH}	$R_L = 2\text{ k}\Omega$ to 2.5 V $T_A = -40^\circ\text{C to } +85^\circ\text{C}$	4.935 4.900			V
	V_{OL}	$R_L = 2\text{ k}\Omega$ to 2.5 V $T_A = -40^\circ\text{C to } +85^\circ\text{C}$			65 75	mV
Output Short Circuit Current (Note 2)	I_O	Sourcing = $V_O = 0\text{ V}$ Sinking = $V_O = 5\text{ V}$	10 10	60 160		mA
Supply Current	I_{CC}	$T_A = -40^\circ\text{C to } +85^\circ\text{C}$			200	μA

5.0 V AC ELECTRICAL CHARACTERISTICS (Unless otherwise specified, all limits are guaranteed for $T_A = 25^\circ\text{C}$, $V_{CC} = 5.0\text{ V}$, $R_L = 1\text{ M}\Omega$, $V_{EE} = 0\text{ V}$, $V_O = V_{CC}/2$)

Parameter	Symbol	Condition	Min	Typ	Max	Unit
Slew Rate	S_R			1		$\text{V}/\mu\text{s}$
Gain Bandwidth Product	GBWP	$C_L = 200\text{ pF}$		1		MHz
Phase Margin	Θ_m			60		$^\circ$
Gain Margin	G_m			10		dB
Input-Referred Voltage Noise	e_n	$f = 50\text{ kHz}$		50		$\text{nV}/\sqrt{\text{Hz}}$
Total Harmonic Distortion	THD	$A_V = +1$, $V - 1\text{ V}_{PP}$, $R_L = 10\text{ kW}$, $f = 1\text{ kHz}$		0.01		%

2. Guaranteed by design and/or characterization.

LMV301

TYPICAL CHARACTERISTICS

($T_A = 25^\circ\text{C}$ and $V_S = 5\text{ V}$ unless otherwise specified)

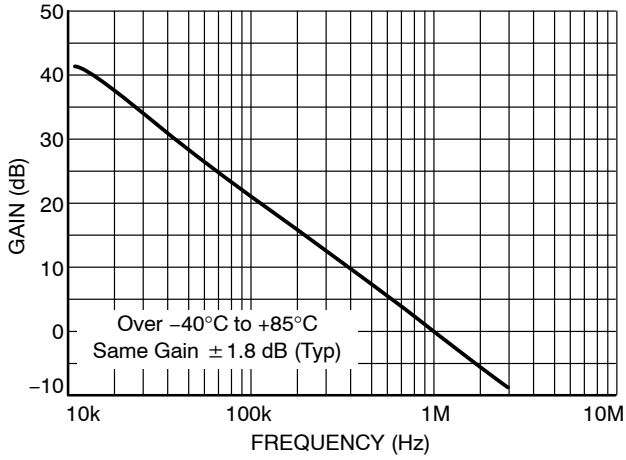

Figure 1. Open Loop Frequency Response
($R_L = 2\text{ k}\Omega$, $T_A = 25^\circ\text{C}$, $V_S = 5\text{ V}$)

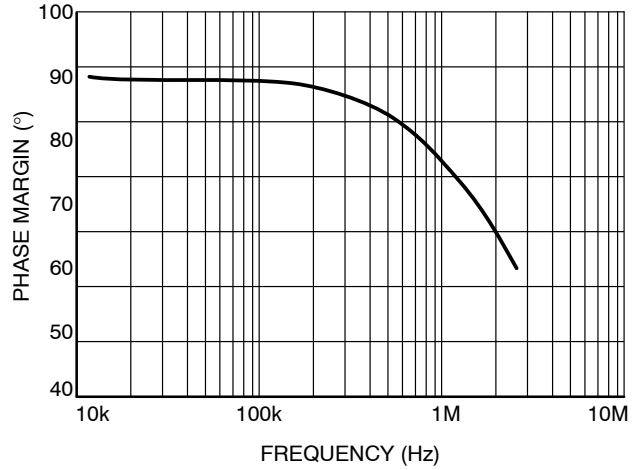

Figure 2. Open Loop Phase Margin
($R_L = 2\text{ k}\Omega$, $T_A = 25^\circ\text{C}$)

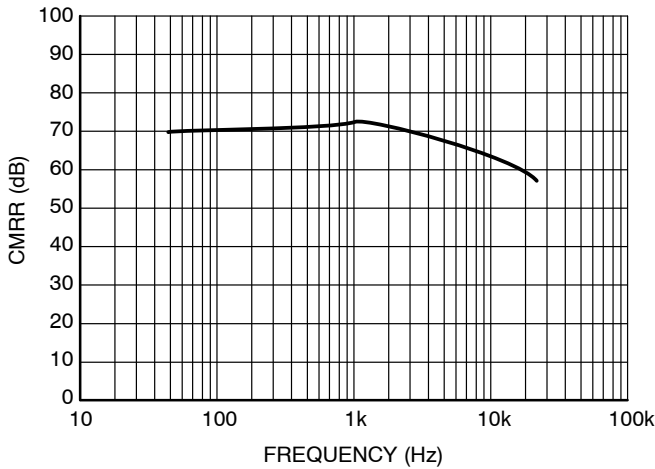

Figure 3. CMRR vs. Frequency
($R_L = 5\text{ k}\Omega$, $V_S = 5\text{ V}$)

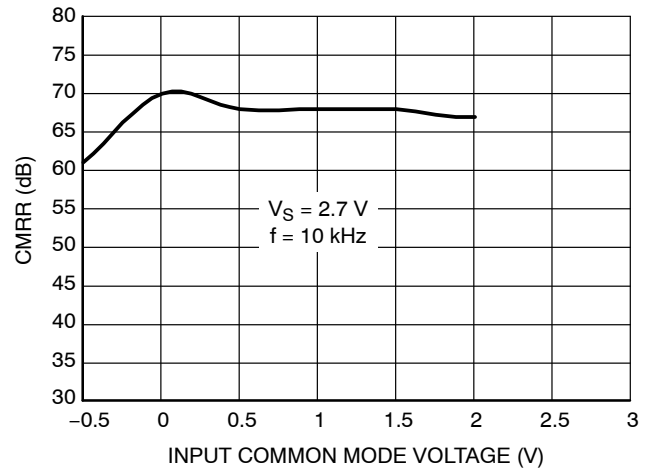

Figure 4. CMRR vs. Input Common Mode Voltage

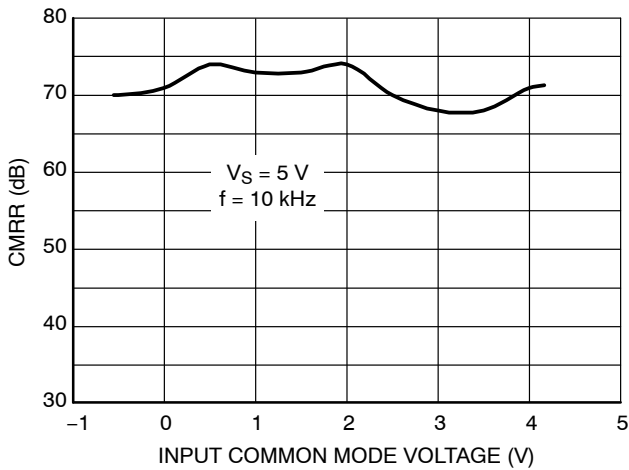

Figure 5. CMRR vs. Input Common Mode Voltage

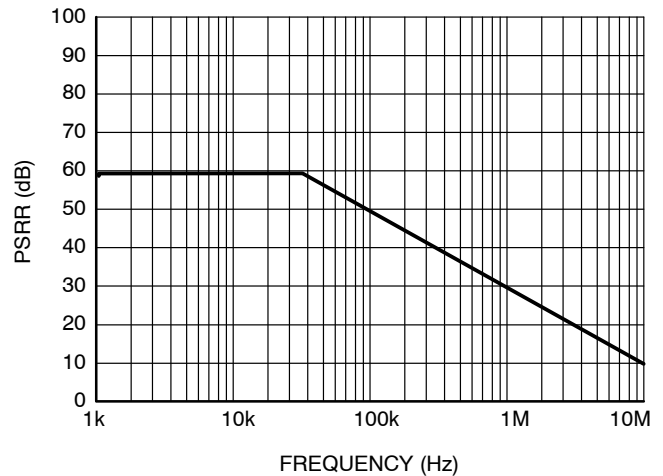

Figure 6. PSRR vs. Frequency
($R_L = 5\text{ k}\Omega$, $V_S = 2.7\text{ V}$, +PSRR)

LMV301

TYPICAL CHARACTERISTICS

($T_A = 25^\circ\text{C}$ and $V_S = 5\text{ V}$ unless otherwise specified)

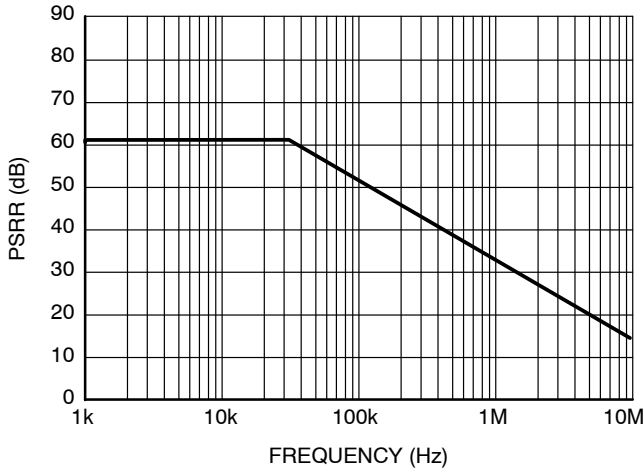

Figure 7. PSRR vs. Frequency
($R_L = 5\text{ k}\Omega$, $V_S = 2.7\text{ V}$, $-\text{PSRR}$)

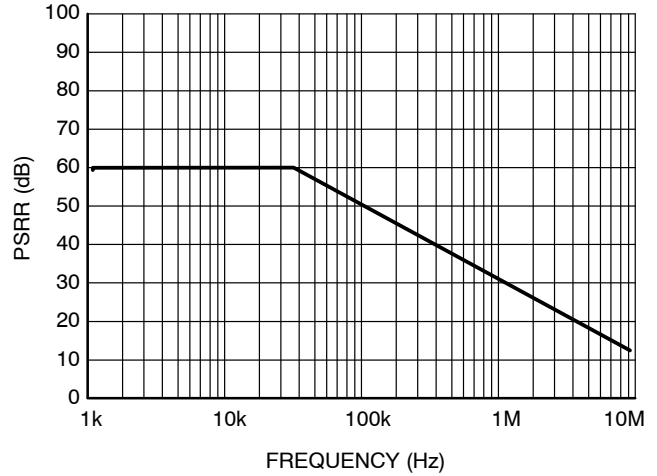

Figure 8. PSRR vs. Frequency
($R_L = 5\text{ k}\Omega$, $V_S = 5\text{ V}$, $+\text{PSRR}$)

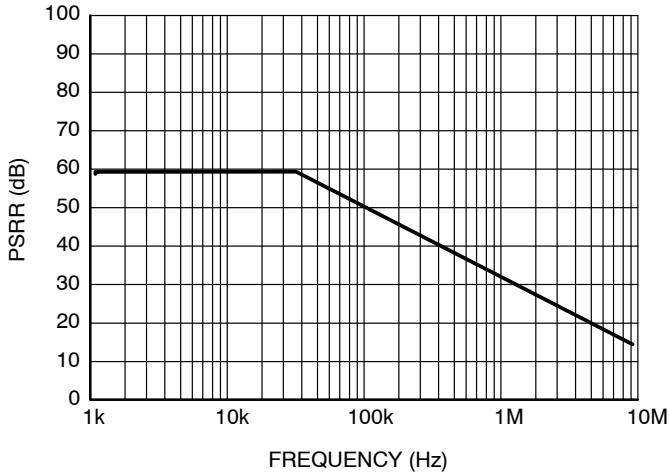

Figure 9. PSRR vs. Frequency
($R_L = 5\text{ k}\Omega$, $V_S = 5\text{ V}$, $-\text{PSRR}$)

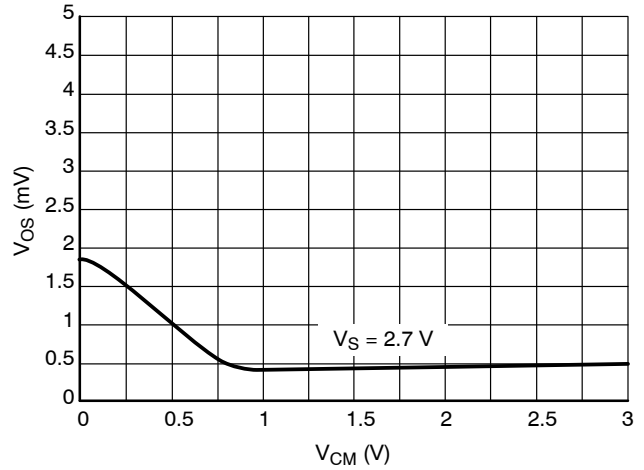

Figure 10. V_{OS} vs. CMR

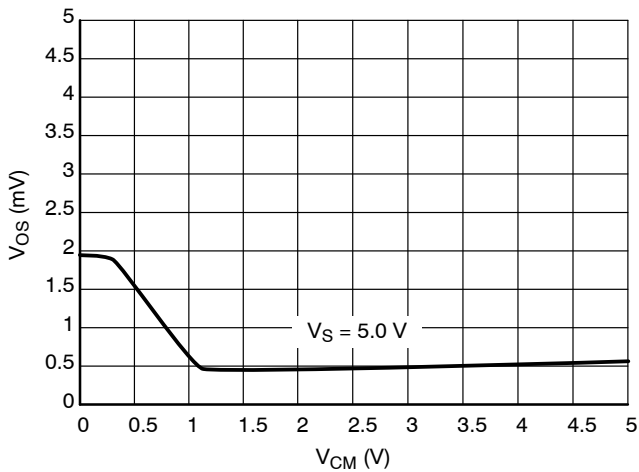

Figure 11. V_{OS} vs. CMR

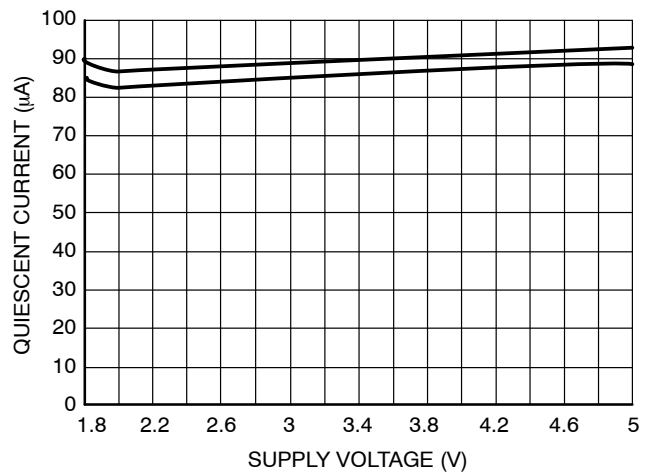

Figure 12. Supply Current vs. Supply Voltage

LMV301

TYPICAL CHARACTERISTICS

($T_A = 25^\circ\text{C}$ and $V_S = 5\text{ V}$ unless otherwise specified)

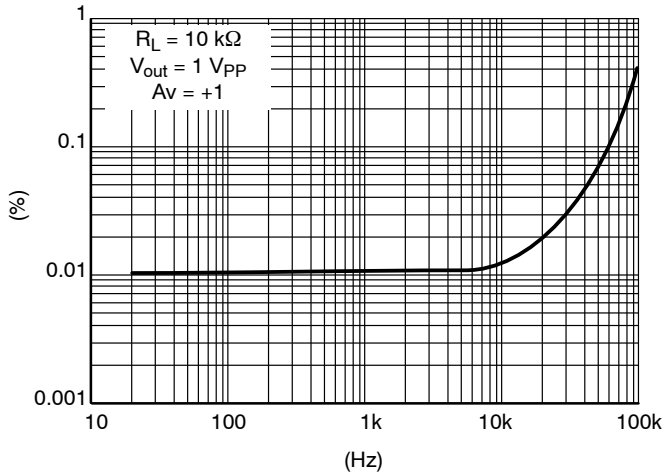

Figure 13. THD+N vs Frequency

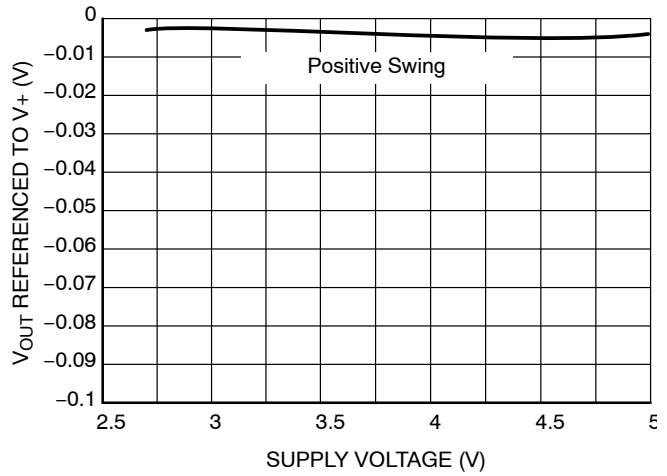

Figure 14. Output Voltage Swing vs Supply Voltage ($R_L = 10\text{ k}$)

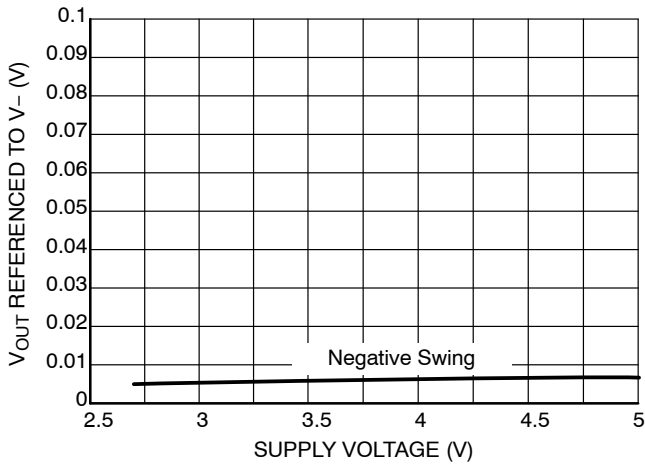

Figure 15. Output Voltage Swing vs Supply Voltage ($R_L = 10\text{ k}$)

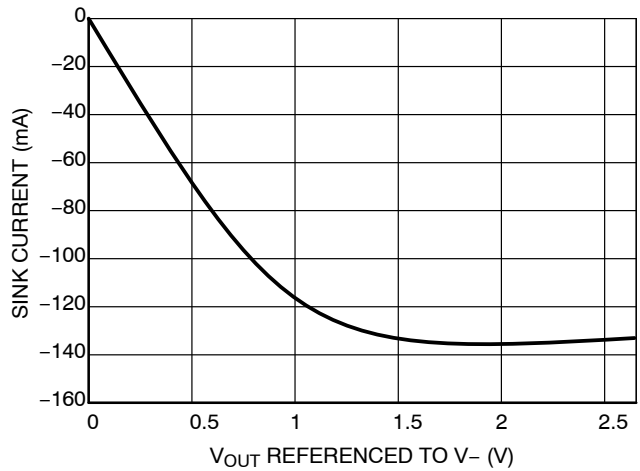

Figure 16. Sink Current vs. Output Voltage
 $V_S = 2.7\text{ V}$

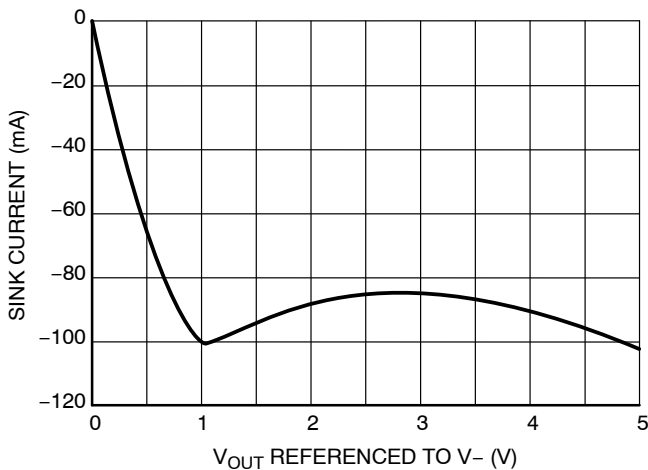

Figure 17. Sink Current vs. Output Voltage
 $V_S = 5.0\text{ V}$

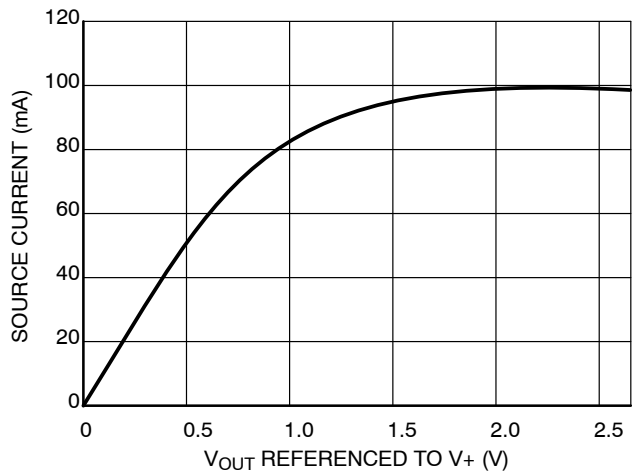

Figure 18. Source Current vs. Output Voltage
 $V_S = 2.7\text{ V}$

LMV301

TYPICAL CHARACTERISTICS

($T_A = 25^\circ\text{C}$ and $V_S = 5\text{ V}$ unless otherwise specified)

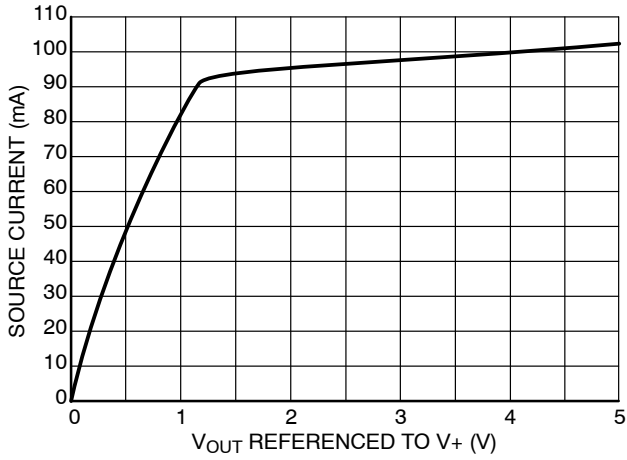

Figure 19. Source Current vs. Output Voltage
 $V_S = 5.0\text{ V}$

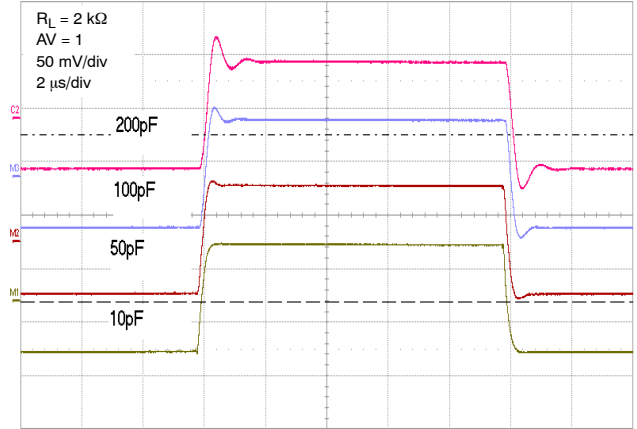

Figure 20. Settling Time vs. Capacitive Load

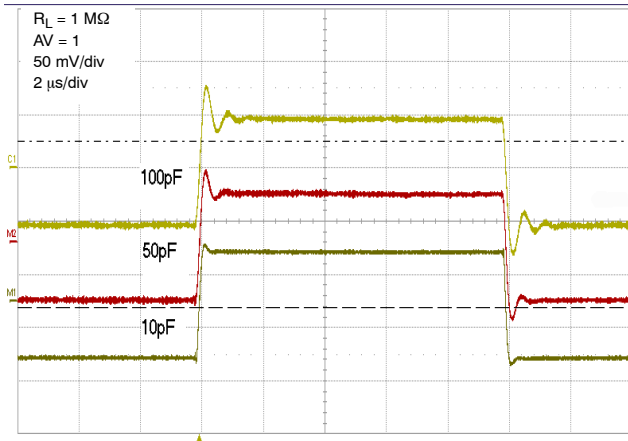

Figure 21. Settling Time vs. Capacitive Load

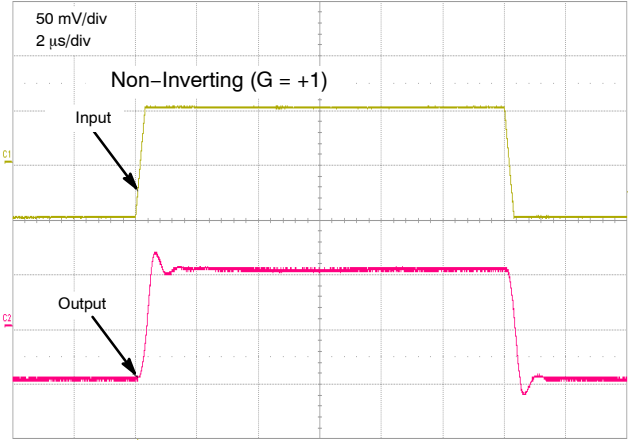

Figure 22. Step Response - Small Signal

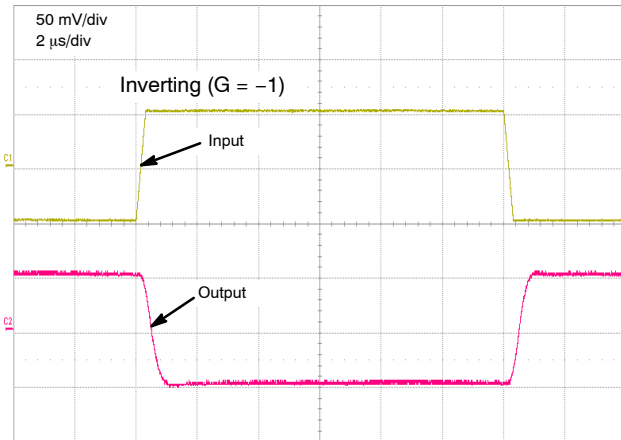

Figure 23. Step Response - Small Signal

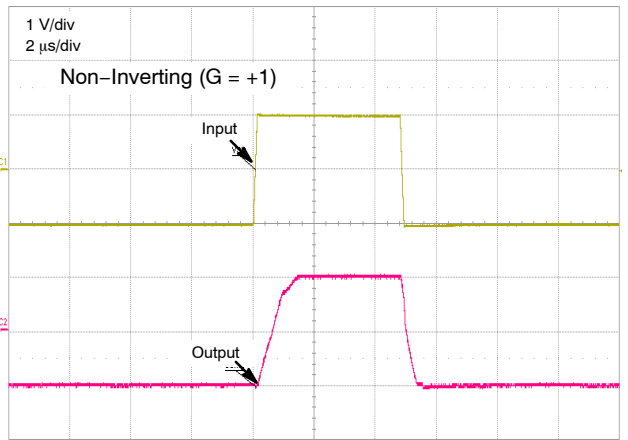

Figure 24. Step Response - Large Signal

LMV301

TYPICAL CHARACTERISTICS

($T_A = 25^\circ\text{C}$ and $V_S = 5\text{ V}$ unless otherwise specified)

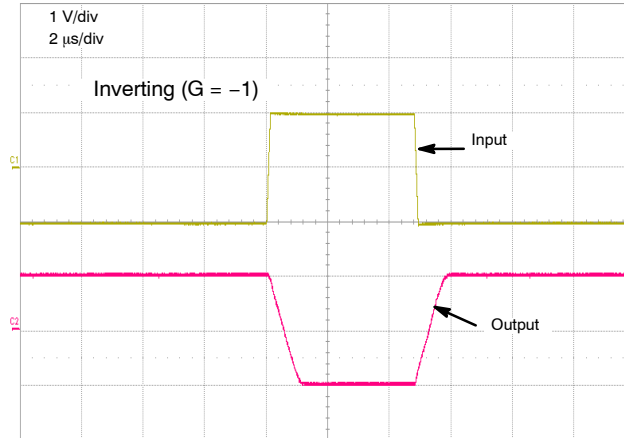

Figure 25. Step Response – Large Signal

LMV301

APPLICATIONS

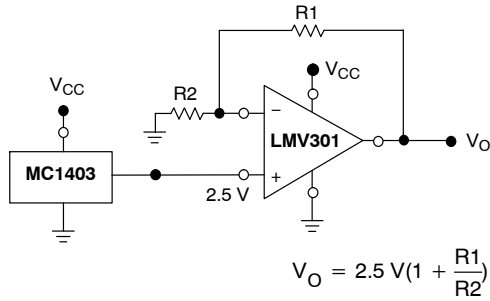

Figure 26. Voltage Reference

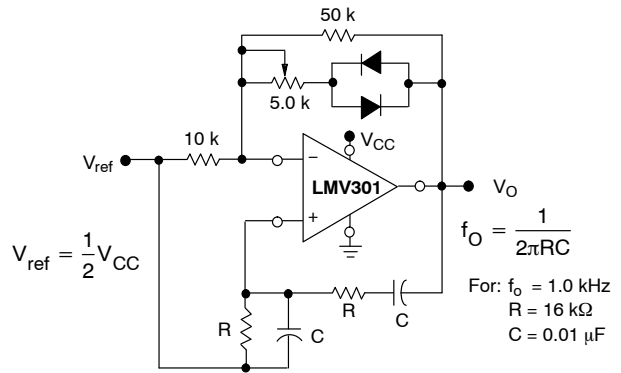

Figure 27. Wien Bridge Oscillator

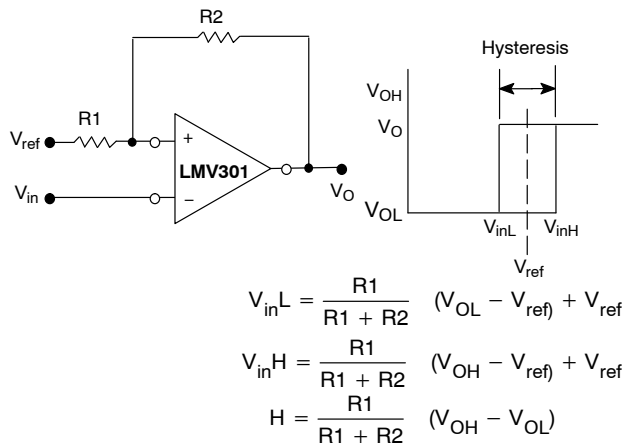
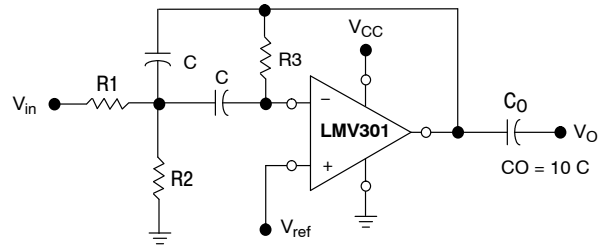

Figure 28. Comparator with Hysteresis



Given: $f_o = \text{center frequency}$
 $A(f_o) = \text{gain at center frequency}$

Choose value f_o, C

$$\text{Then: } R_3 = \frac{Q}{\pi f_o C}$$

$$R_1 = \frac{R_3}{2 A(f_o)}$$

$$R_2 = \frac{R_1 R_3}{4Q^2 R_1 - R_3}$$

For less than 10% error from operational amplifier, $((Q_o f_o)/BW) < 0.1$ where f_o and BW are expressed in Hz. If source impedance varies, filter may be preceded with voltage follower buffer to stabilize filter parameters.

Figure 29. Multiple Feedback Bandpass Filter

ORDERING INFORMATION

Device	Pinout Style	Marking	Package	Shipping†
LMV301SQ3T2G	Style 3	AAD	SC70-5 (Pb-Free)	3000 / Tape & Reel

†For information on tape and reel specifications, including part orientation and tape sizes, please refer to our Tape and Reel Packaging Specifications Brochure, BRD8011/D.

MECHANICAL CASE OUTLINE

PACKAGE DIMENSIONS

ON Semiconductor®



SCALE 2:1

SC-88A (SC-70-5/SOT-353)
CASE 419A-02
ISSUE L

DATE 17 JAN 2013

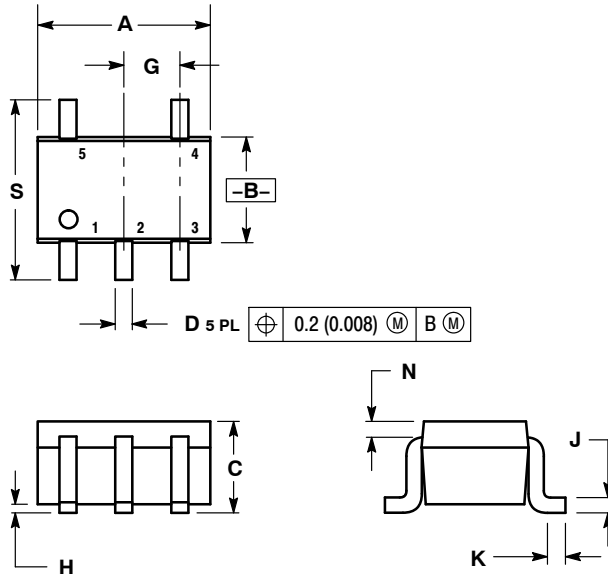

SOLDER FOOTPRINT

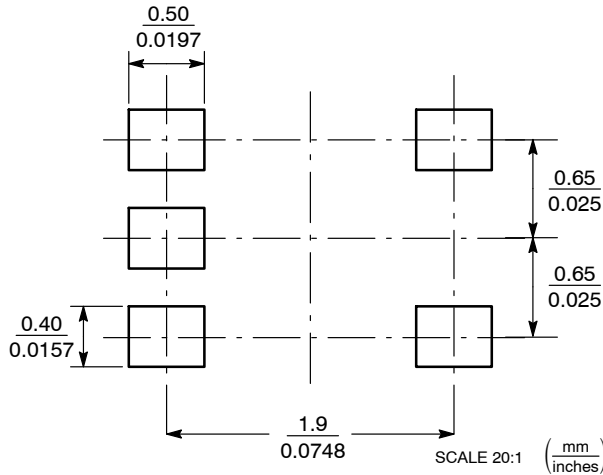

NOTES:

1. DIMENSIONING AND TOLERANCING PER ANSI Y14.5M, 1982.
2. CONTROLLING DIMENSION: INCH.
3. 419A-01 OBSOLETE. NEW STANDARD 419A-02.
4. DIMENSIONS A AND B DO NOT INCLUDE MOLD FLASH, PROTRUSIONS, OR GATE BURRS.

DIM	INCHES		MILLIMETERS	
	MIN	MAX	MIN	MAX
A	0.071	0.087	1.80	2.20
B	0.045	0.053	1.15	1.35
C	0.031	0.043	0.80	1.10
D	0.004	0.012	0.10	0.30
G	0.026 BSC		0.65 BSC	
H	---	0.004	---	0.10
J	0.004	0.010	0.10	0.25
K	0.004	0.012	0.10	0.30
N	0.008 REF		0.20 REF	
S	0.079	0.087	2.00	2.20

GENERIC MARKING DIAGRAM*

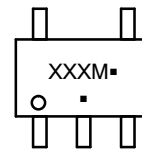

- XXX = Specific Device Code
- M = Date Code
- = Pb-Free Package

(Note: Microdot may be in either location)

*This information is generic. Please refer to device data sheet for actual part marking. Pb-Free indicator, "G" or microdot "■", may or may not be present. Some products may not follow the Generic Marking.

- | | | | | |
|--|--|--|--|--|
| <p>STYLE 1:
PIN 1. BASE
2. EMITTER
3. BASE
4. COLLECTOR
5. COLLECTOR</p> | <p>STYLE 2:
PIN 1. ANODE
2. EMITTER
3. BASE
4. COLLECTOR
5. CATHODE</p> | <p>STYLE 3:
PIN 1. ANODE 1
2. N/C
3. ANODE 2
4. CATHODE 2
5. CATHODE 1</p> | <p>STYLE 4:
PIN 1. SOURCE 1
2. DRAIN 1/2
3. SOURCE 1
4. GATE 1
5. GATE 2</p> | <p>STYLE 5:
PIN 1. CATHODE
2. COMMON ANODE
3. CATHODE 2
4. CATHODE 3
5. CATHODE 4</p> |
| <p>STYLE 6:
PIN 1. EMITTER 2
2. BASE 2
3. EMITTER 1
4. COLLECTOR
5. COLLECTOR 2/BASE 1</p> | <p>STYLE 7:
PIN 1. BASE
2. EMITTER
3. BASE
4. COLLECTOR
5. COLLECTOR</p> | <p>STYLE 8:
PIN 1. CATHODE
2. COLLECTOR
3. N/C
4. BASE
5. EMITTER</p> | <p>STYLE 9:
PIN 1. ANODE
2. CATHODE
3. ANODE
4. ANODE
5. ANODE</p> | <p>Note: Please refer to datasheet for style callout. If style type is not called out in the datasheet refer to the device datasheet pinout or pin assignment.</p> |

DOCUMENT NUMBER:	98ASB42984B	Electronic versions are uncontrolled except when accessed directly from the Document Repository. Printed versions are uncontrolled except when stamped "CONTROLLED COPY" in red.
DESCRIPTION:	SC-88A (SC-70-5/SOT-353)	PAGE 1 OF 1

ON Semiconductor and ON are trademarks of Semiconductor Components Industries, LLC dba ON Semiconductor or its subsidiaries in the United States and/or other countries. ON Semiconductor reserves the right to make changes without further notice to any products herein. ON Semiconductor makes no warranty, representation or guarantee regarding the suitability of its products for any particular purpose, nor does ON Semiconductor assume any liability arising out of the application or use of any product or circuit, and specifically disclaims any and all liability, including without limitation special, consequential or incidental damages. ON Semiconductor does not convey any license under its patent rights nor the rights of others.

MECHANICAL CASE OUTLINE PACKAGE DIMENSIONS

ON Semiconductor®



SCALE 2:1

TSOP-5 CASE 483 ISSUE N

DATE 12 AUG 2020

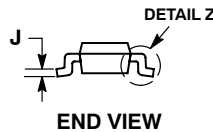
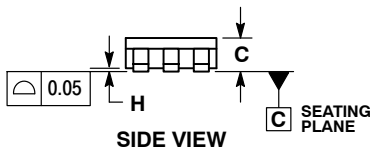
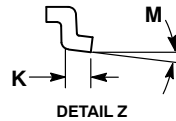
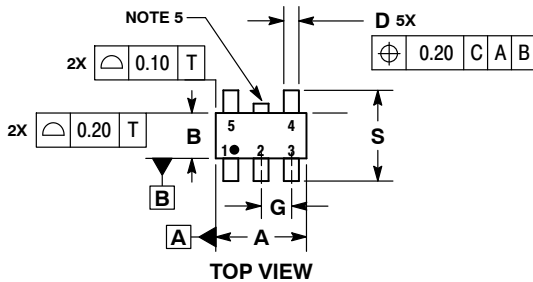

NOTES:

1. DIMENSIONING AND TOLERANCING PER ASME Y14.5M, 1994.
2. CONTROLLING DIMENSION: MILLIMETERS.
3. MAXIMUM LEAD THICKNESS INCLUDES LEAD FINISH THICKNESS. MINIMUM LEAD THICKNESS IS THE MINIMUM THICKNESS OF BASE MATERIAL.
4. DIMENSIONS A AND B DO NOT INCLUDE MOLD FLASH, PROTRUSIONS, OR GATE BURRS. MOLD FLASH, PROTRUSIONS, OR GATE BURRS SHALL NOT EXCEED 0.15 PER SIDE. DIMENSION A.
5. OPTIONAL CONSTRUCTION: AN ADDITIONAL TRIMMED LEAD IS ALLOWED IN THIS LOCATION. TRIMMED LEAD NOT TO EXTEND MORE THAN 0.2 FROM BODY.

DIM	MILLIMETERS	
	MIN	MAX
A	2.85	3.15
B	1.35	1.65
C	0.90	1.10
D	0.25	0.50
G	0.95 BSC	
H	0.01	0.10
J	0.10	0.26
K	0.20	0.60
M	0°	10°
S	2.50	3.00

SOLDERING FOOTPRINT*

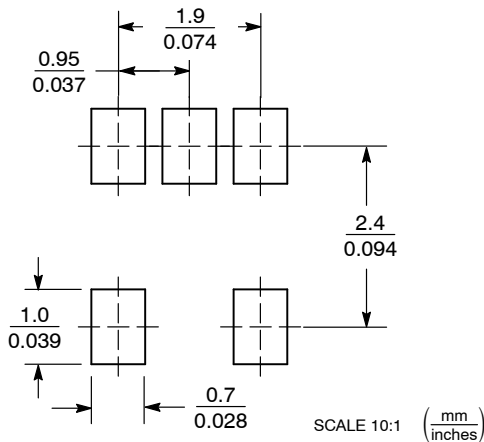

*For additional information on our Pb-Free strategy and soldering details, please download the ON Semiconductor Soldering and Mounting Techniques Reference Manual, SOLDERRM/D.

GENERIC MARKING DIAGRAM*

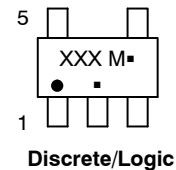
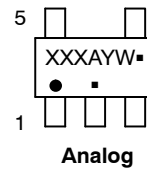

- XXX = Specific Device Code
 A = Assembly Location
 Y = Year
 W = Work Week
 ■ = Pb-Free Package
- XXX = Specific Device Code
 M = Date Code
 ■ = Pb-Free Package

(Note: Microdot may be in either location)

*This information is generic. Please refer to device data sheet for actual part marking. Pb-Free indicator, "G" or microdot "■", may or may not be present.

DOCUMENT NUMBER:	98ARB18753C	Electronic versions are uncontrolled except when accessed directly from the Document Repository. Printed versions are uncontrolled except when stamped "CONTROLLED COPY" in red.
DESCRIPTION:	TSOP-5	PAGE 1 OF 1

ON Semiconductor and ON are trademarks of Semiconductor Components Industries, LLC dba ON Semiconductor or its subsidiaries in the United States and/or other countries. ON Semiconductor reserves the right to make changes without further notice to any products herein. ON Semiconductor makes no warranty, representation or guarantee regarding the suitability of its products for any particular purpose, nor does ON Semiconductor assume any liability arising out of the application or use of any product or circuit, and specifically disclaims any and all liability, including without limitation special, consequential or incidental damages. ON Semiconductor does not convey any license under its patent rights nor the rights of others.

onsemi, **Onsemi**, and other names, marks, and brands are registered and/or common law trademarks of Semiconductor Components Industries, LLC dba "**onsemi**" or its affiliates and/or subsidiaries in the United States and/or other countries. **onsemi** owns the rights to a number of patents, trademarks, copyrights, trade secrets, and other intellectual property. A listing of **onsemi**'s product/patent coverage may be accessed at www.onsemi.com/site/pdf/Patent-Marking.pdf. **onsemi** reserves the right to make changes at any time to any products or information herein, without notice. The information herein is provided "as-is" and **onsemi** makes no warranty, representation or guarantee regarding the accuracy of the information, product features, availability, functionality, or suitability of its products for any particular purpose, nor does **onsemi** assume any liability arising out of the application or use of any product or circuit, and specifically disclaims any and all liability, including without limitation special, consequential or incidental damages. Buyer is responsible for its products and applications using **onsemi** products, including compliance with all laws, regulations and safety requirements or standards, regardless of any support or applications information provided by **onsemi**. "Typical" parameters which may be provided in **onsemi** data sheets and/or specifications can and do vary in different applications and actual performance may vary over time. All operating parameters, including "Typicals" must be validated for each customer application by customer's technical experts. **onsemi** does not convey any license under any of its intellectual property rights nor the rights of others. **onsemi** products are not designed, intended, or authorized for use as a critical component in life support systems or any FDA Class 3 medical devices or medical devices with a same or similar classification in a foreign jurisdiction or any devices intended for implantation in the human body. Should Buyer purchase or use **onsemi** products for any such unintended or unauthorized application, Buyer shall indemnify and hold **onsemi** and its officers, employees, subsidiaries, affiliates, and distributors harmless against all claims, costs, damages, and expenses, and reasonable attorney fees arising out of, directly or indirectly, any claim of personal injury or death associated with such unintended or unauthorized use, even if such claim alleges that **onsemi** was negligent regarding the design or manufacture of the part. **onsemi** is an Equal Opportunity/Affirmative Action Employer. This literature is subject to all applicable copyright laws and is not for resale in any manner.

PUBLICATION ORDERING INFORMATION

LITERATURE FULFILLMENT:

Email Requests to: orderlit@onsemi.com

onsemi Website: www.onsemi.com

TECHNICAL SUPPORT

North American Technical Support:

Voice Mail: 1 800-282-9855 Toll Free USA/Canada

Phone: 011 421 33 790 2910

Europe, Middle East and Africa Technical Support:

Phone: 00421 33 790 2910

For additional information, please contact your local Sales Representative

Mouser Electronics

Authorized Distributor

Click to View Pricing, Inventory, Delivery & Lifecycle Information:

[onsemi:](#)

[LMV301SQ3T2G](#) [LMV301SN3T1G](#)