

# MCV 1,5/10-G-3,5 - PCB header



1843680

<https://www.phoenixcontact.com/us/products/1843680>

Please be informed that the data shown in this PDF document is generated from our Online Catalog. Please find the complete data in the user documentation. Our General Terms of Use for Downloads are valid.

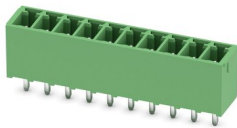

PCB headers, nominal cross section: 1.5 mm<sup>2</sup>, color: green, nominal current: 8 A, rated voltage (III/2): 160 V, contact surface: Tin, type of contact: Pin, number of potentials: 10, number of rows: 1, number of positions: 10, number of connections: 10, product range: MCV 1,5/-G, pitch: 3.5 mm, mounting: Wave soldering, pin layout: Linear pinning, solder pin [P]: 3.4 mm, number of solder pins per potential: 1, plug-in system: COMBICON MC 1,5, Pin connector pattern alignment: Standard, locking: without, mounting: without, type of packaging: packed in cardboard

## Your advantages

- Well-known mounting principle allows worldwide use
- Vertical connection enables multi-row arrangement on the PCB
- Maximum flexibility when it comes to device design – one header for connectors with different connection technologies

## Commercial Data

Item number	1843680
Packing unit	1 pc
Minimum order quantity	100 pc
Sales Key	AA02
Product Key	AABSAE
Catalog Page	Page 226 (C-1-2013)
GTIN	4017918112837
Weight per Piece (including packing)	2.612 g
Weight per Piece (excluding packing)	2.612 g
Customs tariff number	85366930
Country of origin	DE

# MCV 1,5/10-G-3,5 - PCB header



1843680

<https://www.phoenixcontact.com/us/products/1843680>

## Technical Data

### Product properties

Type	Standard
Product line	COMBICON Connectors S
Product type	PCB headers
Product family	MCV 1,5/..-G
Number of positions	10
Pitch	3.5 mm
Number of connections	10
Number of rows	1
Mounting flange	without
Number of potentials	10
Pin layout	Linear pinning
Solder pins per potential	1

### Electrical properties

Nominal current $I_N$	8 A
Nominal voltage $U_N$	160 V
Degree of pollution	3
Contact resistance	1.8 m $\Omega$
Rated voltage (III/3)	160 V
Rated surge voltage (III/3)	2.5 kV
Rated voltage (III/2)	160 V
Rated surge voltage (III/2)	2.5 kV
Rated voltage (II/2)	250 V
Rated surge voltage (II/2)	2.5 kV

### Mounting

Mounting type	Wave soldering
Pin layout	Linear pinning

### Material specifications

#### Material data - contact

Note	WEEE/RoHS-compliant, free of whiskers according to IEC 60068-2-82/JEDEC JESD 201
Contact material	Cu alloy
Surface characteristics	Tin-plated
Metal surface contact area (top layer)	Tin (3 - 5 $\mu\text{m}$ Sn)
Metal surface contact area (middle layer)	Nickel (1 - 3 $\mu\text{m}$ Ni)
Metal surface soldering area (top layer)	Tin (3 - 5 $\mu\text{m}$ Sn)
Metal surface soldering area (middle layer)	Nickel (1 - 3 $\mu\text{m}$ Ni)

#### Material data - housing

# MCV 1,5/10-G-3,5 - PCB header

1843680

<https://www.phoenixcontact.com/us/products/1843680>

Color (Housing)	green (6021)
Insulating material	PBT
Insulating material group	IIIa
CTI according to IEC 60112	225
Flammability rating according to UL 94	V0

## Material data – actuating element

Color ()	()
----------	----

## Dimensions

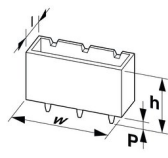
Dimensional drawing	
Pitch	3.5 mm
Width [w]	36.4 mm
Height [h]	12.6 mm
Length [l]	7.25 mm
Installed height	9.2 mm
Solder pin length [P]	3.4 mm

## Mechanical tests

### Test for conductor damage and slackening

Specification	IEC 60999-1:1999-11
Result	Test passed

### Pull-out test

Specification	IEC 60999-1:1999-11
Conductor cross section/conductor type/tractive force setpoint/actual value	0.2 mm <sup>2</sup> / solid / > 10 N
	0.2 mm <sup>2</sup> / flexible / > 10 N
	1.5 mm <sup>2</sup> / solid / > 40 N
	1.5 mm <sup>2</sup> / flexible / > 40 N

### Insertion and withdrawal forces

Result	Test passed
No. of cycles	25
Insertion strength per pos. approx.	6 N
Withdraw strength per pos. approx.	4 N

### Torque test

Specification	IEC 60999-1:1999-11
---------------	---------------------

### Contact holder in insert

Specification	IEC 60512-15-1:2008-05
---------------	------------------------

# MCV 1,5/10-G-3,5 - PCB header



1843680

<https://www.phoenixcontact.com/us/products/1843680>

Contact holder in insert Requirements >20 N	Test passed
Resistance of inscriptions	
Specification	IEC 60068-2-70:1995-12
Result	Test passed
Polarization and coding	
Specification	IEC 60512-13-5:2006-02
Result	Test passed
Visual inspection	
Specification	IEC 60512-1-1:2002-02
Result	Test passed
Dimension check	
Specification	IEC 60512-1-2:2002-02
Result	Test passed

## Electrical tests

### Thermal test | Test group C

Specification	IEC 60512-5-1:2002-02
Tested number of positions	20

### Insulation resistance

Specification	IEC 60512-3-1:2002-02
Insulation resistance, neighboring positions	> 5 MΩ

### Air clearances and creepage distances |

Specification	IEC 60664-1:2007-04
Insulating material group	IIIa
Comparative tracking index (IEC 60112)	CTI 225
Rated insulation voltage (III/3)	160 V
Rated surge voltage (III/3)	2.5 kV
minimum clearance value - non-homogenous field (III/3)	1.5 mm
minimum creepage distance (III/3)	2.5 mm
Rated insulation voltage (III/2)	160 V
Rated surge voltage (III/2)	2.5 kV
minimum clearance value - non-homogenous field (III/2)	1.5 mm
minimum creepage distance (III/2)	1.6 mm
Rated insulation voltage (II/2)	250 V
Rated surge voltage (II/2)	2.5 kV
minimum clearance value - non-homogenous field (II/2)	1.5 mm
minimum creepage distance (II/2)	2.5 mm

## Environmental and real-life conditions

# MCV 1,5/10-G-3,5 - PCB header



1843680

<https://www.phoenixcontact.com/us/products/1843680>

## Vibration test

Specification	IEC 60068-2-6:2007-12
Frequency	10 - 150 - 10 Hz
Sweep speed	1 octave/min
Amplitude	0.35 mm (10 Hz ... 60.1 Hz)
Sweep speed	5g (60.1 Hz ... 150 Hz)
Test duration per axis	2.5 h

## Durability test

Specification	IEC 60512-5:1992-08
Impulse withstand voltage at sea level	2.95 kV
Contact resistance R <sub>1</sub>	1.8 mΩ
Contact resistance R <sub>2</sub>	2.2 mΩ
Insertion/withdrawal cycles	25

## Climatic test

Specification	ISO 6988:1985-02
Corrosive stress	0.2 dm <sup>3</sup> SO <sub>2</sub> on 300 dm <sup>3</sup> /40 °C/1 cycle
Thermal stress	100 °C/168 h
Power-frequency withstand voltage	1.39 kV

## Ambient conditions

Ambient temperature (operation)	-40 °C ... 100 °C (dependent on the derating curve)
Ambient temperature (storage/transport)	-40 °C ... 70 °C
Relative humidity (storage/transport)	30 % ... 70 %
Ambient temperature (assembly)	-5 °C ... 100 °C

## Packaging specifications

Type of packaging	packed in cardboard
-------------------	---------------------

## Drawings

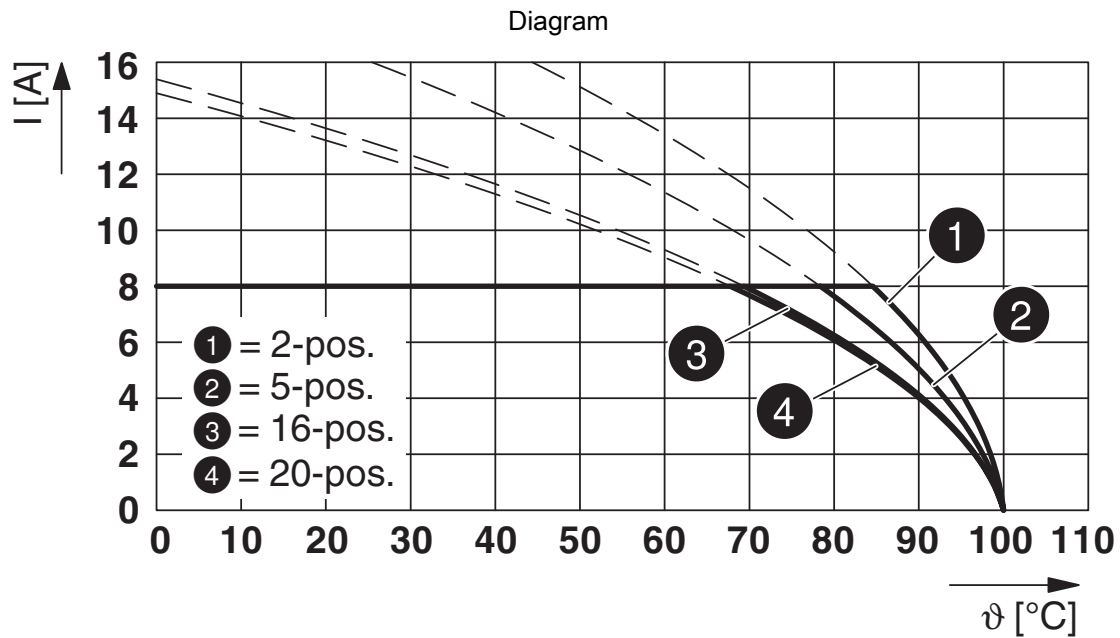

Type: FMC 1,5/...-ST-3,5 with MCV 1,5/...-G-3,5

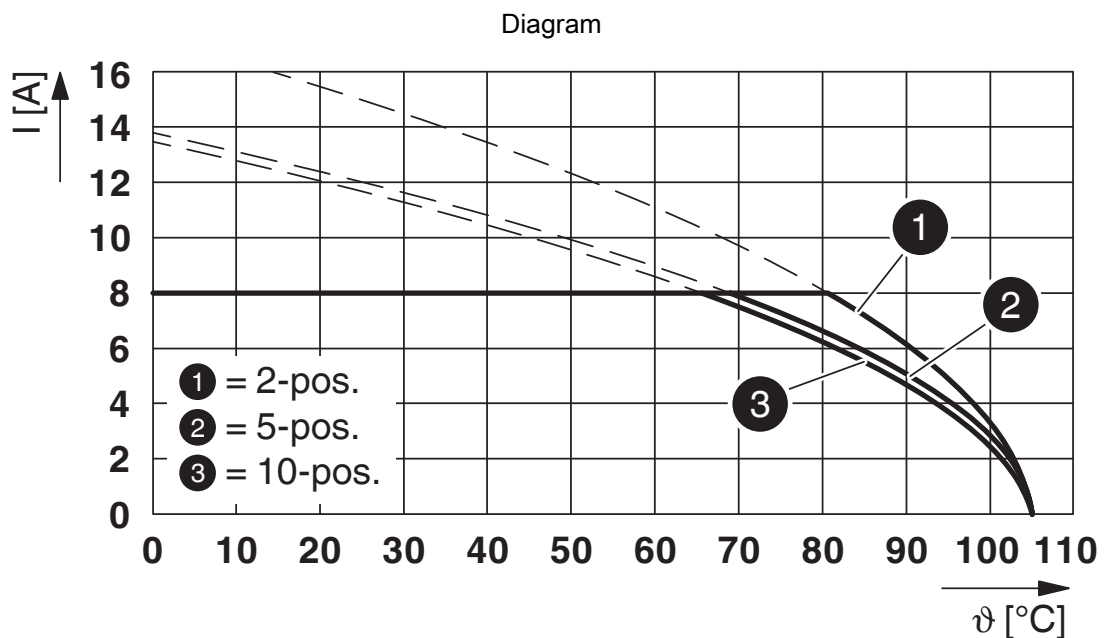

Type: TFMC 1,5/...-ST-3,5 with MCV 1,5/...-G-3,5

# MCV 1,5/10-G-3,5 - PCB header

1843680

<https://www.phoenixcontact.com/us/products/1843680>

Diagram

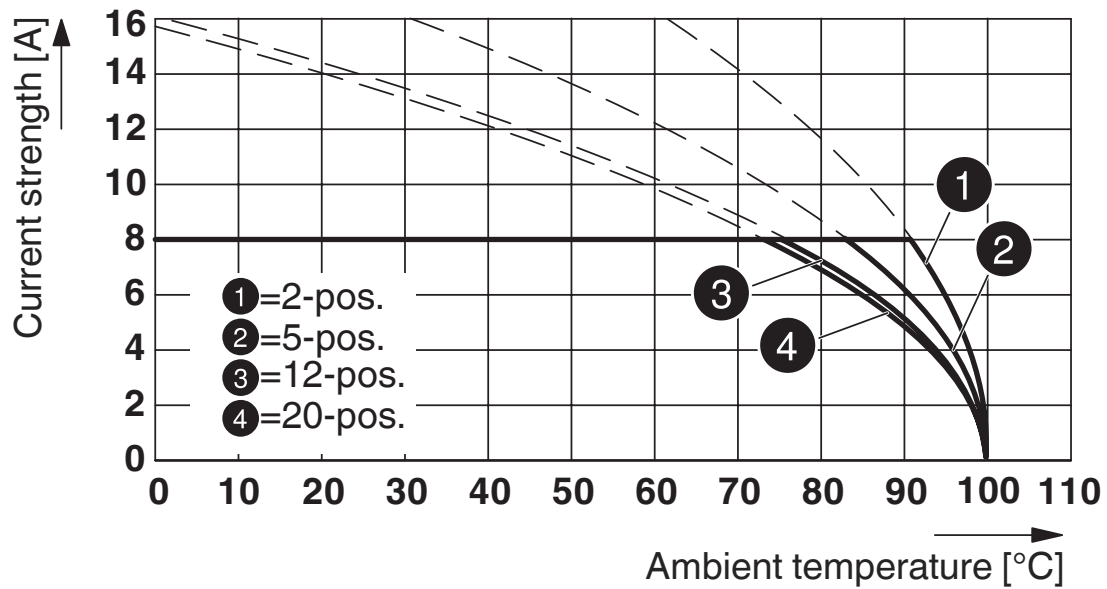

Type: MC 1,5/...-ST-3,5 with MCV 1,5/...-G-3,5

Dimensional drawing

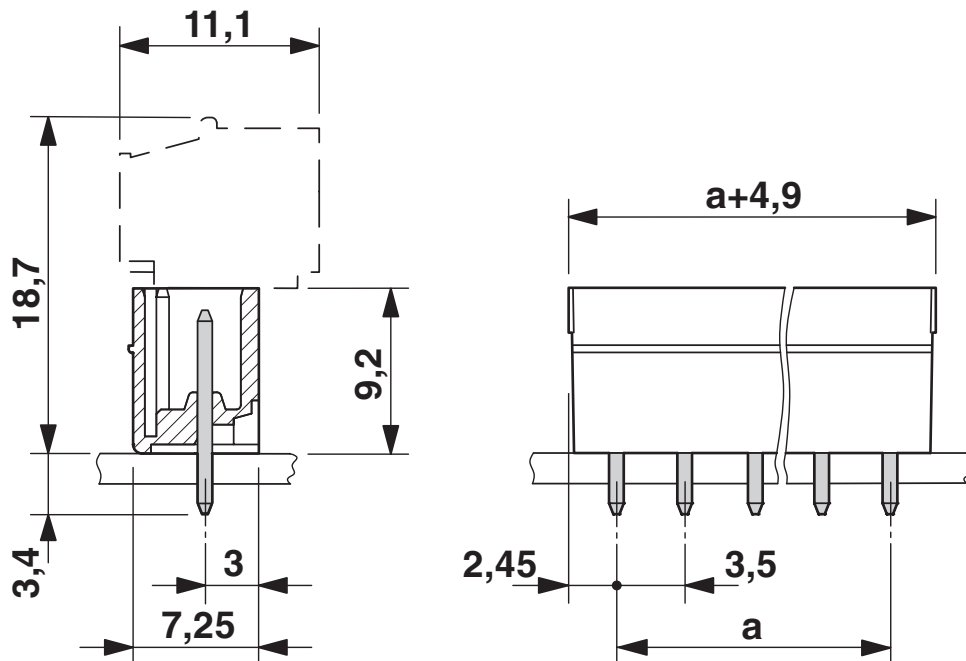

# MCV 1,5/10-G-3,5 - PCB header

1843680

<https://www.phoenixcontact.com/us/products/1843680>

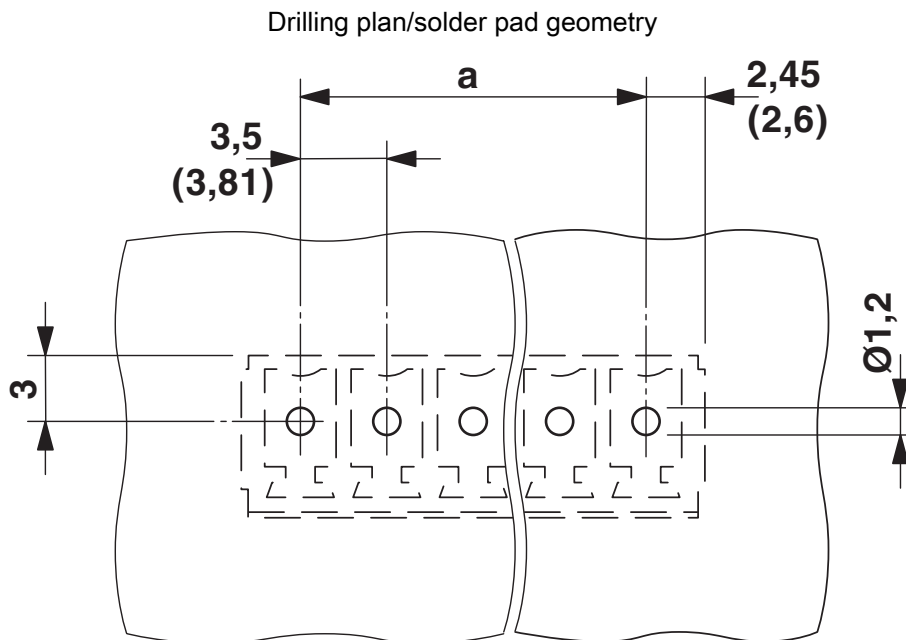

Diagram

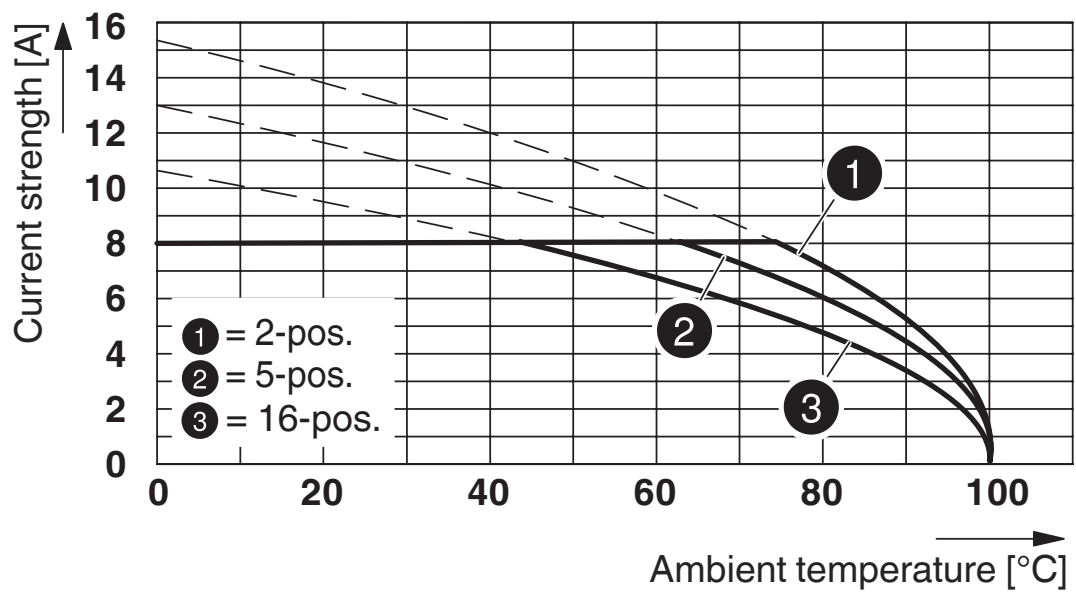

Type: MCVW 1,5/...-ST-3,5 with MCV 1,5/...-G-3,5



# MCV 1,5/10-G-3,5 - PCB header



1843680

<https://www.phoenixcontact.com/us/products/1843680>

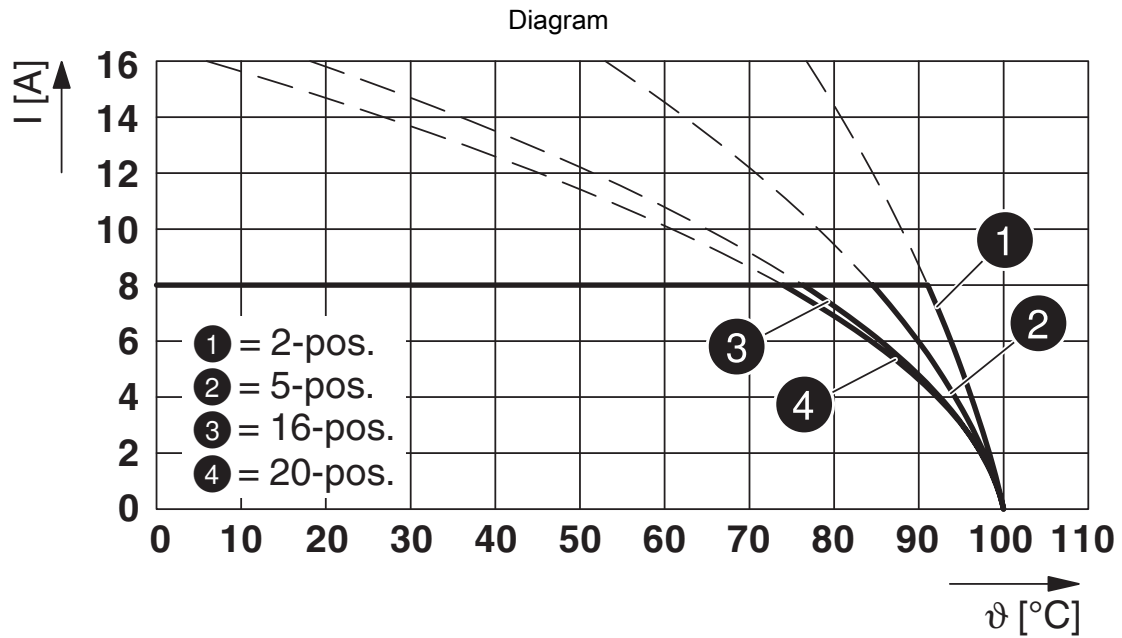

Type: FK-MCP 1,5/...-ST-3,5 with MCV 1,5/...-G-3,5

# MCV 1,5/10-G-3,5 - PCB header



1843680

<https://www.phoenixcontact.com/us/products/1843680>

## Approvals

 <b>CSA</b> Approval ID: 13631				
	Nominal Voltage $U_N$	Nominal Current $I_N$	Cross Section AWG	Cross Section $\text{mm}^2$
Use group B	300 V	8 A	-	-
Use group D	300 V	8 A	-	-

 <b>IECEE CB Scheme</b> Approval ID: DE1-60987-B1B2				
	Nominal Voltage $U_N$	Nominal Current $I_N$	Cross Section AWG	Cross Section $\text{mm}^2$
	160 V	8 A	-	-

 <b>EAC</b> Approval ID: B.01687				
--	--	--	--	--

 <b>cULus Recognized</b> Approval ID: E60425-20110128				
	Nominal Voltage $U_N$	Nominal Current $I_N$	Cross Section AWG	Cross Section $\text{mm}^2$
Use group B	300 V	8 A	-	-
Use group D	300 V	8 A	-	-

 <b>VDE Zeichengenehmigung</b> Approval ID: 40011723				
	Nominal Voltage $U_N$	Nominal Current $I_N$	Cross Section AWG	Cross Section $\text{mm}^2$
	160 V	8 A	-	-

# MCV 1,5/10-G-3,5 - PCB header

1843680

<https://www.phoenixcontact.com/us/products/1843680>



## Classifications

### ECLASS

ECLASS-11.0	27460201
ECLASS-12.0	27460201
ECLASS-13.0	27460201

### ETIM

ETIM 8.0	EC002637
----------	----------

### UNSPSC

UNSPSC 21.0	39121400
-------------	----------

# MCV 1,5/10-G-3,5 - PCB header

1843680

<https://www.phoenixcontact.com/us/products/1843680>



## Environmental Product Compliance

China RoHS	Environmentally friendly use period: unlimited = EFUP-e
	No hazardous substances above threshold values

# MCV 1,5/10-G-3,5 - PCB header

1843680

<https://www.phoenixcontact.com/us/products/1843680>



## Accessories

### SK U/2,8 WH:UNBEDRUCKT - Marker card

0803883

<https://www.phoenixcontact.com/us/products/0803883>



Marker card, Sheet, white, unlabeled, can be labeled with: PLOTMARK, CMS-P1-PLOTTER, Office printing systems, mounting type: adhesive, for terminal block width: 210 mm, lettering field size: 186 x 2.8 mm, Number of individual labels: 3600

### SK 3,5/2,8:FORTL.ZAHLEN - Marker card

0804073

<https://www.phoenixcontact.com/us/products/0804073>



Marker card, white, labeled, horizontal: consecutive numbers 1 ... 10, 11 ... 20, etc. up to 91 ... 99, mounting type: adhesive, for terminal block width: 3.5 mm, lettering field size: 3.5 x 2.8 mm

# MCV 1,5/10-G-3,5 - PCB header

1843680

<https://www.phoenixcontact.com/us/products/1843680>



## CP-MSTB - Coding profile

1734634

<https://www.phoenixcontact.com/us/products/1734634>

Coding profile, is inserted into the slot on the plug or inverted header, red insulating material



---

## TFMC 1,5/10-ST-3,5 - Printed-circuit board connector

1772692

<https://www.phoenixcontact.com/us/products/1772692>

PCB connector, nominal cross section: 1.5 mm<sup>2</sup>, color: green, nominal current: 8 A, rated voltage (III/2): 160 V, contact surface: Tin, type of contact: Socket, number of potentials: 10, number of rows: 1, number of positions: 10, number of connections: 20, product range: TFMC 1,5/...-ST, pitch: 3.5 mm, connection method: Push-in spring connection, conductor/PCB connection direction: 0 °, plug-in system: COMBICON MC 1,5, locking: without, mounting: without, type of packaging: packed in cardboard

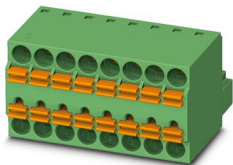

# MCV 1,5/10-G-3,5 - PCB header

1843680

<https://www.phoenixcontact.com/us/products/1843680>



## MC 1,5/10-ST-3,5 - PCB connector

1840447

<https://www.phoenixcontact.com/us/products/1840447>

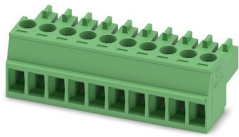

PCB connector, nominal cross section: 1.5 mm<sup>2</sup>, color: green, nominal current: 8 A, rated voltage (III/2): 160 V, contact surface: Tin, type of contact: Socket, number of potentials: 10, number of rows: 1, number of positions: 10, number of connections: 10, product range: MC 1,5/..-ST, pitch: 3.5 mm, connection method: Screw connection with tension sleeve, screw head form: L Slotted, conductor/PCB connection direction: 0 °, plug-in system: COMBICON MC 1,5, locking: without, mounting: without, type of packaging: packed in cardboard

---

## MCVW 1,5/10-ST-3,5 - PCB connector

1862933

<https://www.phoenixcontact.com/us/products/1862933>

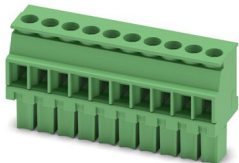

PCB connector, nominal cross section: 1.5 mm<sup>2</sup>, color: green, nominal current: 8 A, rated voltage (III/2): 160 V, contact surface: Tin, type of contact: Socket, number of potentials: 10, number of rows: 1, number of positions: 10, number of connections: 10, product range: MCVW 1,5/..-ST, pitch: 3.5 mm, connection method: Screw connection with tension sleeve, screw head form: L Slotted, conductor/PCB connection direction: -90 °, plug-in system: COMBICON MC 1,5, locking: without, mounting: without, type of packaging: packed in cardboard

# MCV 1,5/10-G-3,5 - PCB header

1843680

<https://www.phoenixcontact.com/us/products/1843680>



## MCVR 1,5/10-ST-3,5 - PCB connector

1863233

<https://www.phoenixcontact.com/us/products/1863233>

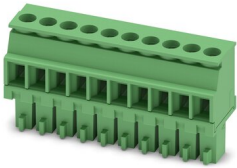

PCB connector, nominal cross section: 1.5 mm<sup>2</sup>, color: green, nominal current: 8 A, rated voltage (III/2): 160 V, contact surface: Tin, type of contact: Socket, number of potentials: 10, number of rows: 1, number of positions: 10, number of connections: 10, product range: MCVR 1,5/..-ST, pitch: 3.5 mm, connection method: Screw connection with tension sleeve, screw head form: L Slotted, conductor/PCB connection direction: 90 °, plug-in system: COMBICON MC 1,5, locking: without, mounting: without, type of packaging: packed in cardboard

## FK-MCP 1,5/10-ST-3,5 - PCB connector

1939989

<https://www.phoenixcontact.com/us/products/1939989>

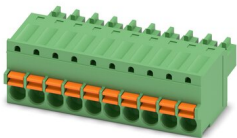

PCB connector, nominal cross section: 1.5 mm<sup>2</sup>, color: green, nominal current: 8 A, rated voltage (III/2): 160 V, contact surface: Tin, type of contact: Socket, number of potentials: 10, number of rows: 1, number of positions: 10, number of connections: 10, product range: FK-MCP 1,5/..-ST, pitch: 3.5 mm, connection method: Push-in spring connection, conductor/PCB connection direction: 0 °, plug-in system: COMBICON MC 1,5, locking: without, mounting: without, type of packaging: packed in cardboard



# MCV 1,5/10-G-3,5 - PCB header

1843680

<https://www.phoenixcontact.com/us/products/1843680>



## FMC 1,5/10-ST-3,5 - Printed-circuit board connector

1952348

<https://www.phoenixcontact.com/us/products/1952348>

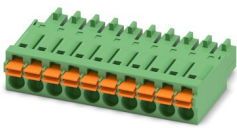

PCB connector, nominal cross section: 1.5 mm<sup>2</sup>, color: green, nominal current: 8 A, rated voltage (III/2): 160 V, contact surface: Tin, type of contact: Socket, number of potentials: 10, number of rows: 1, number of positions: 10, number of connections: 10, product range: FMC 1,5/...-ST, pitch: 3.5 mm, connection method: Push-in spring connection, conductor/PCB connection direction: 0 °, plug-in system: COMBICON MC 1,5, locking: without, mounting: without, type of packaging: packed in cardboard

## XPC 1,5/10-ST-3,5 BK - PCB connector

1464114

<https://www.phoenixcontact.com/us/products/1464114>



PCB connector, nominal cross section: 1.5 mm<sup>2</sup>, color: black, nominal current: 8 A, rated voltage (III/2): 160 V, contact surface: Tin, type of contact: Socket, number of rows: 1, number of positions: 10, product range: XPC 1,5/...-ST, pitch: 3.5 mm, connection method: Push-X-connection, conductor/PCB connection direction: 0 °, locking clip: - without locking clip, plug-in system: COMBICON MC 1,5, locking: without, mounting: without, type of packaging: packed in cardboard

Phoenix Contact 2023 © - all rights reserved  
<https://www.phoenixcontact.com>

Phoenix Contact USA  
586 Fulling Mill Road  
Middletown, PA 17057, United States  
(+717) 944-1300  
[info@phoenixcon.com](mailto:info@phoenixcon.com)